

ALARM DEVICE BASED ON SIMPLE MACHINES

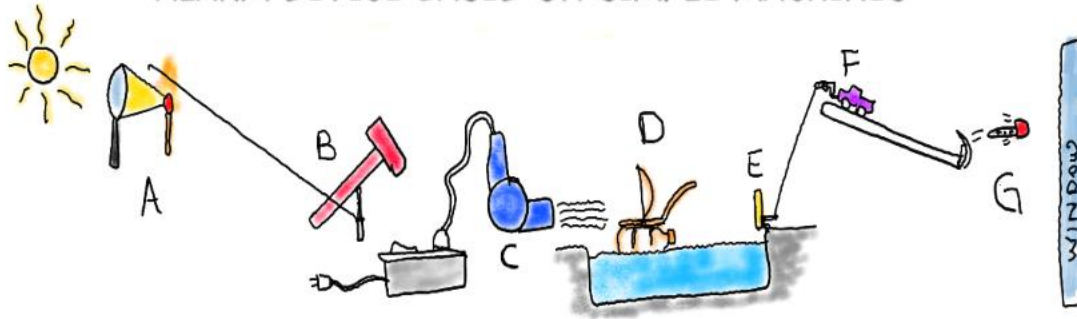

BY JORGE MORENO



THE MAGNIFYING GLASS (A) CONCENTRATES THE SUN'S RAYS AND IGNITES THE PHOSPHOR CAUSING THE HAMMER (B) TO FALL ON THE SWITCH AND TURN ON THE DRYER (C) THAT DRIVES A SAILING SHIP (D), WHICH ACTIVATES A GATE (E) WHICH CAUSES A CAR (F) TO SLIDE ON THE INCLINED PLANE AND LAUNCH A DART (G) THAT CROSSES THE WINDOW AND ACTIVATES A SECOND GATE (H) WHICH CAUSES A BALL TO DESCEND ON THE RAILS (I), THE BALL ACTIVATES AN AUDIBLE ALARM FORMED FOR A SPOON AND A PAN (J). THE BALL ALSO MAKES THE CAR (K) SLIDE ON THE INCLINED PLANE AND ACTIVATES THE MECHANISM (L) THAT REMOVES THE SLEEPING SHEET CAUSING THE SUBJECT TO WAKE UP.





8x
32062, 11



31x
4459, 11



8x
2780, 11



14x
6558, 11

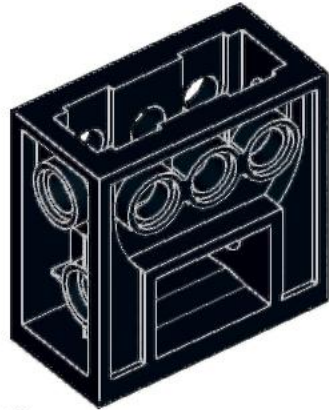

2x
6588, 11



2x
3706, 11

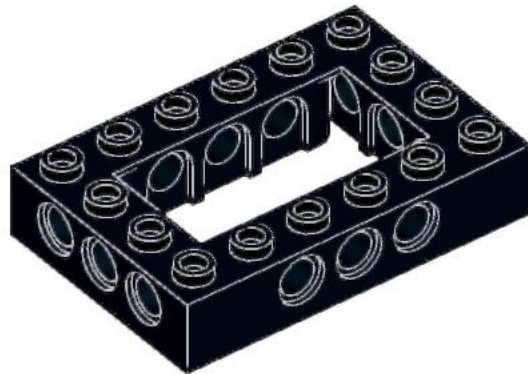

4x
40344, 11



4x
3702, 11

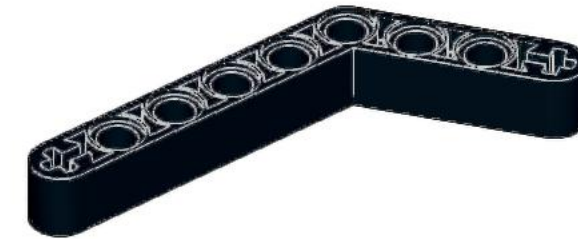

2x
6629, 11



4x
32002, 10



2x
4274, 9



6x
3713, 9

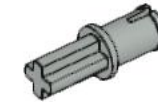

12x
3749, 9



2x
32013, 9

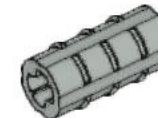

21x
6538b, 9

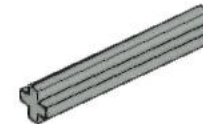

8x
4519, 9

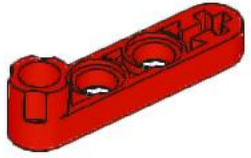

2x
2825, 5

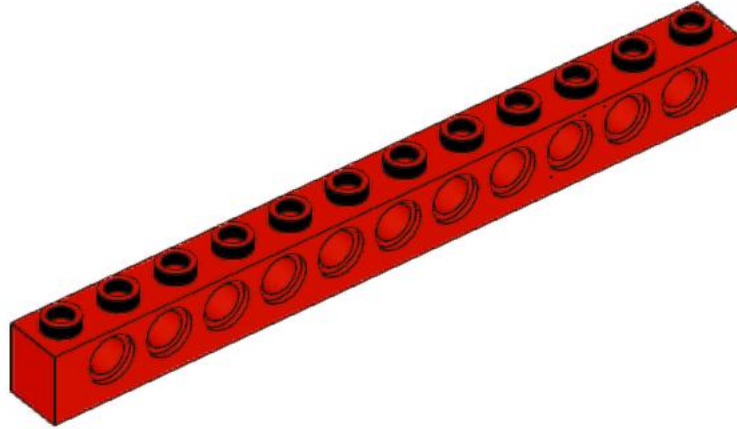

4x
3895, 5

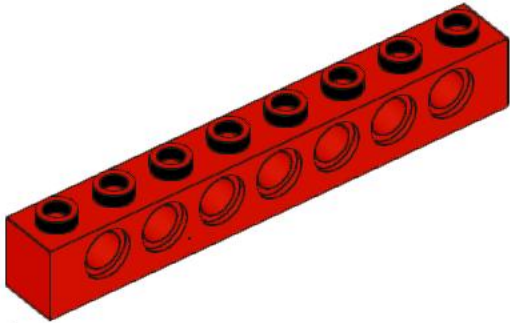

2x
3702, 5

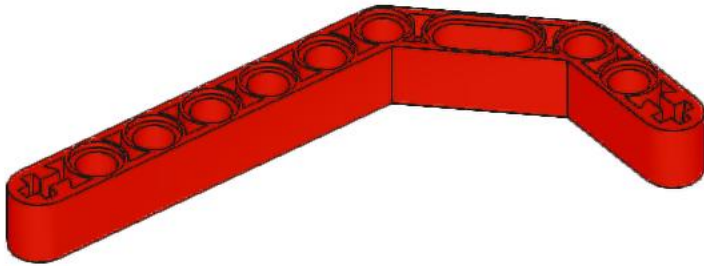

4x
32009, 5

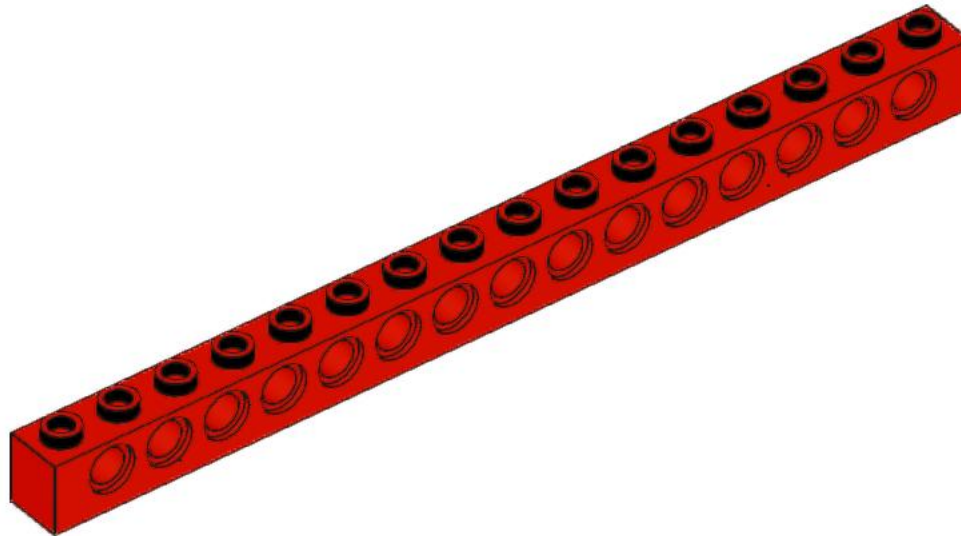

4x
3703, 5

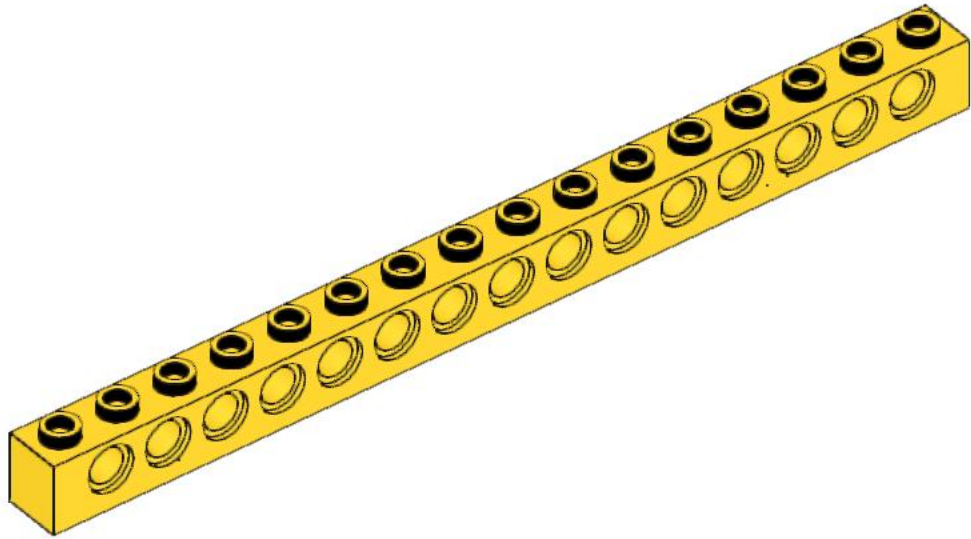

12x
3703, 3

1

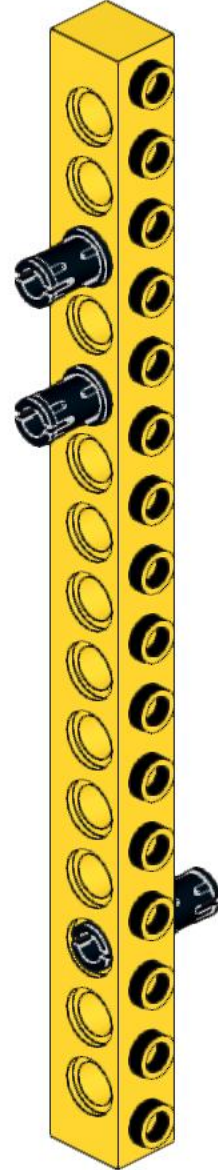
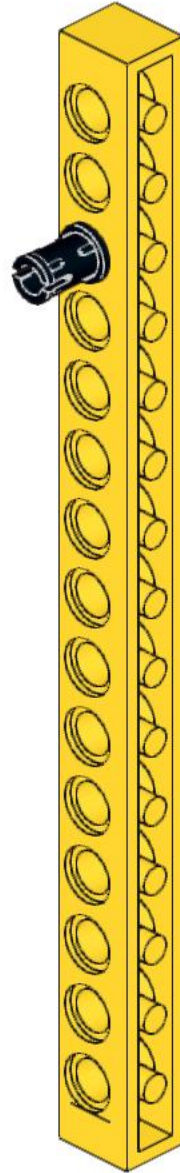
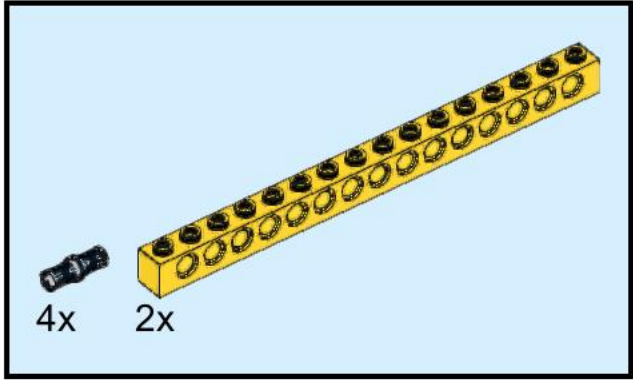

2

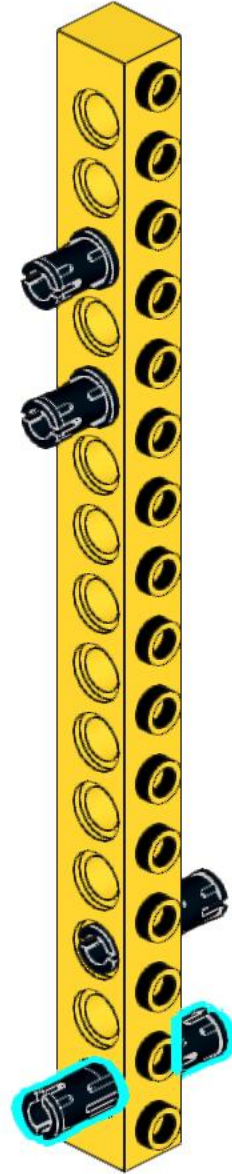
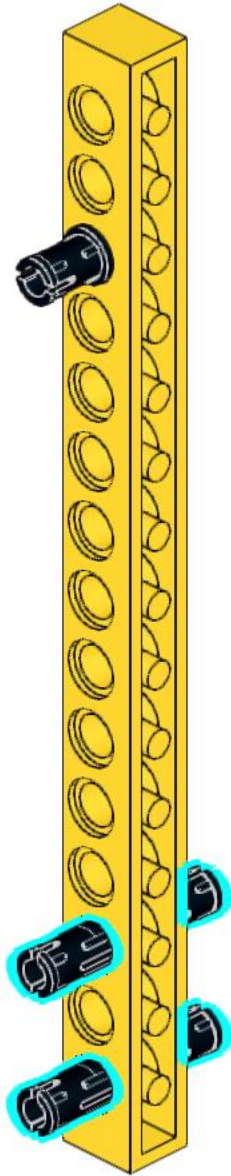

3

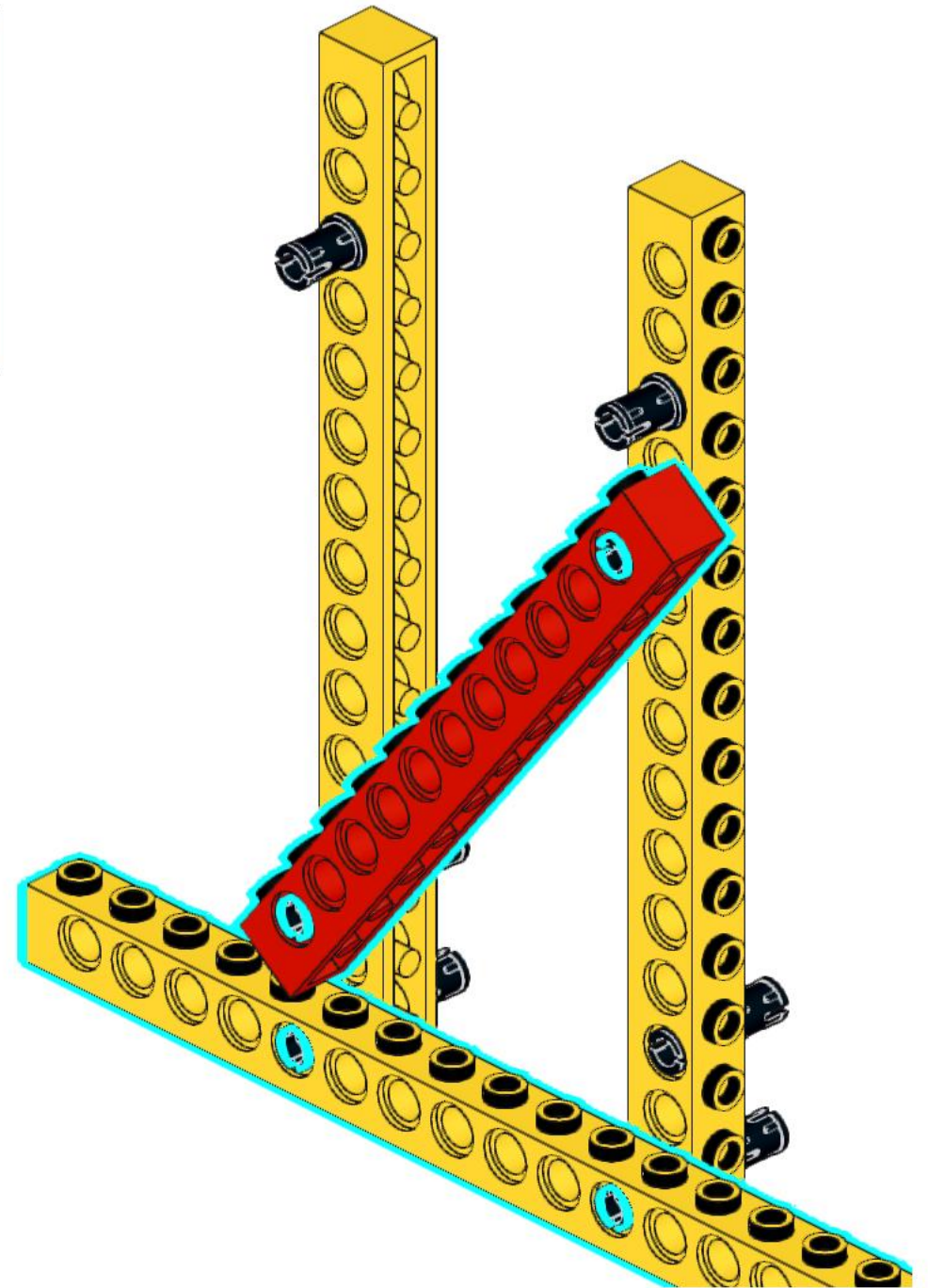
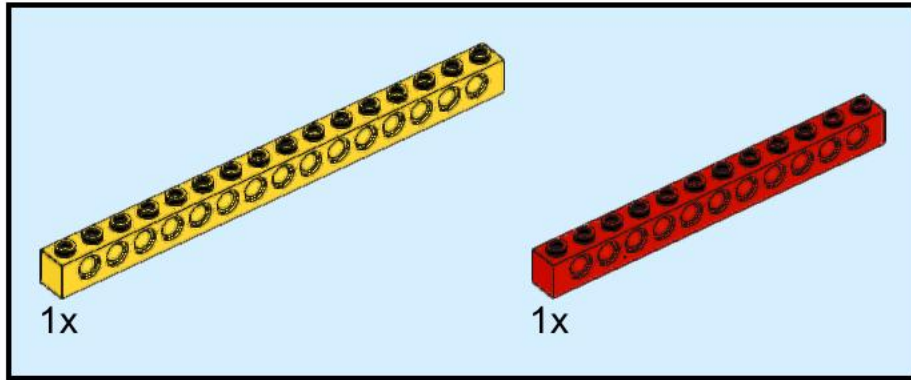

4

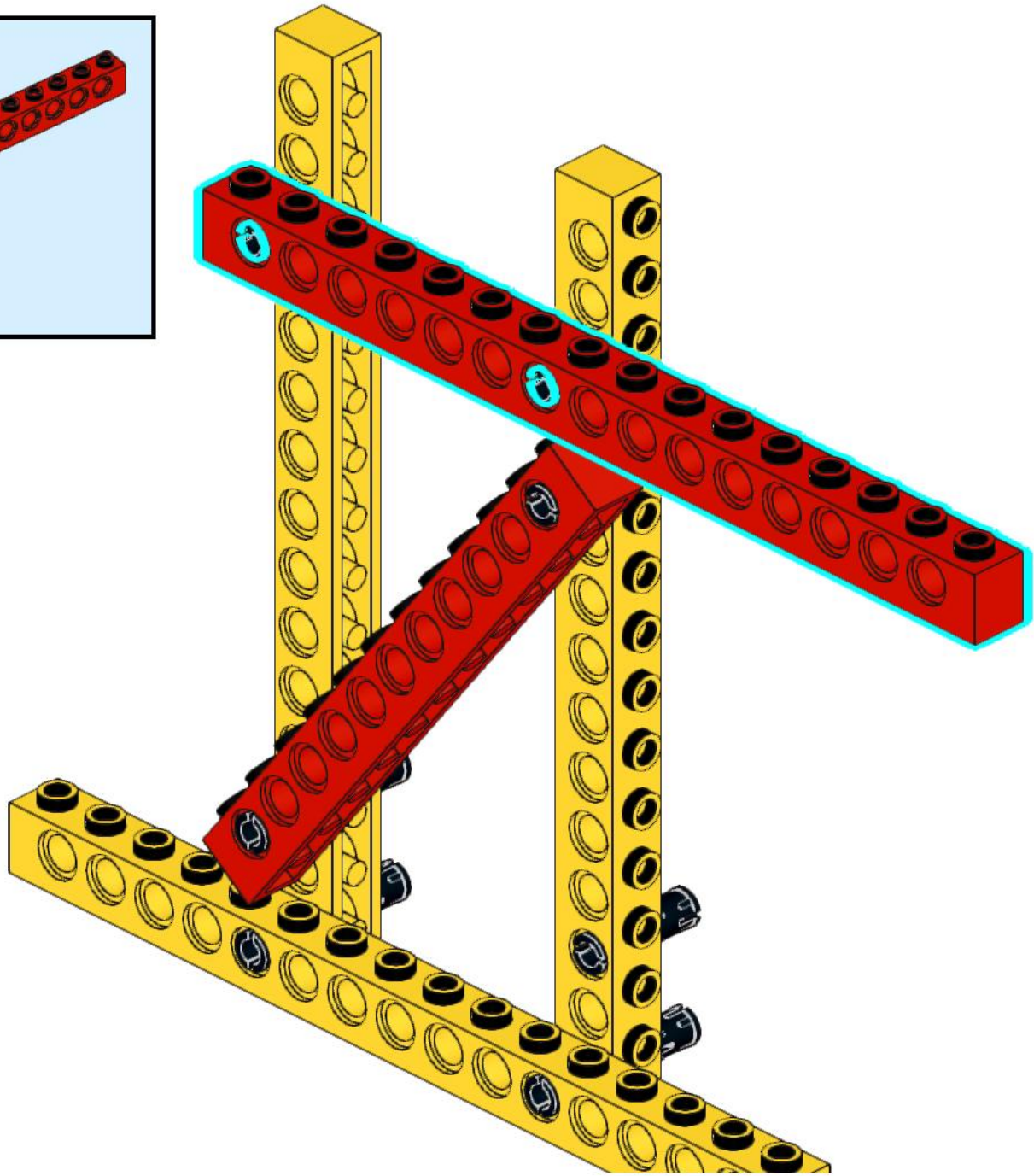
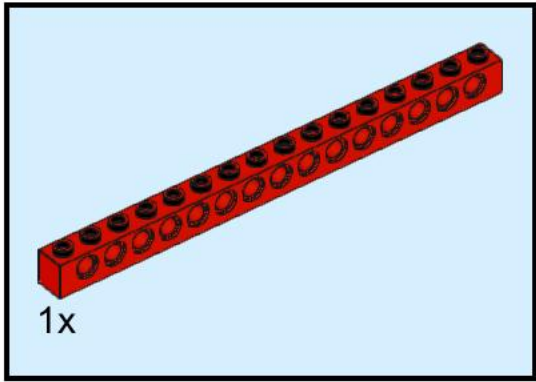

5

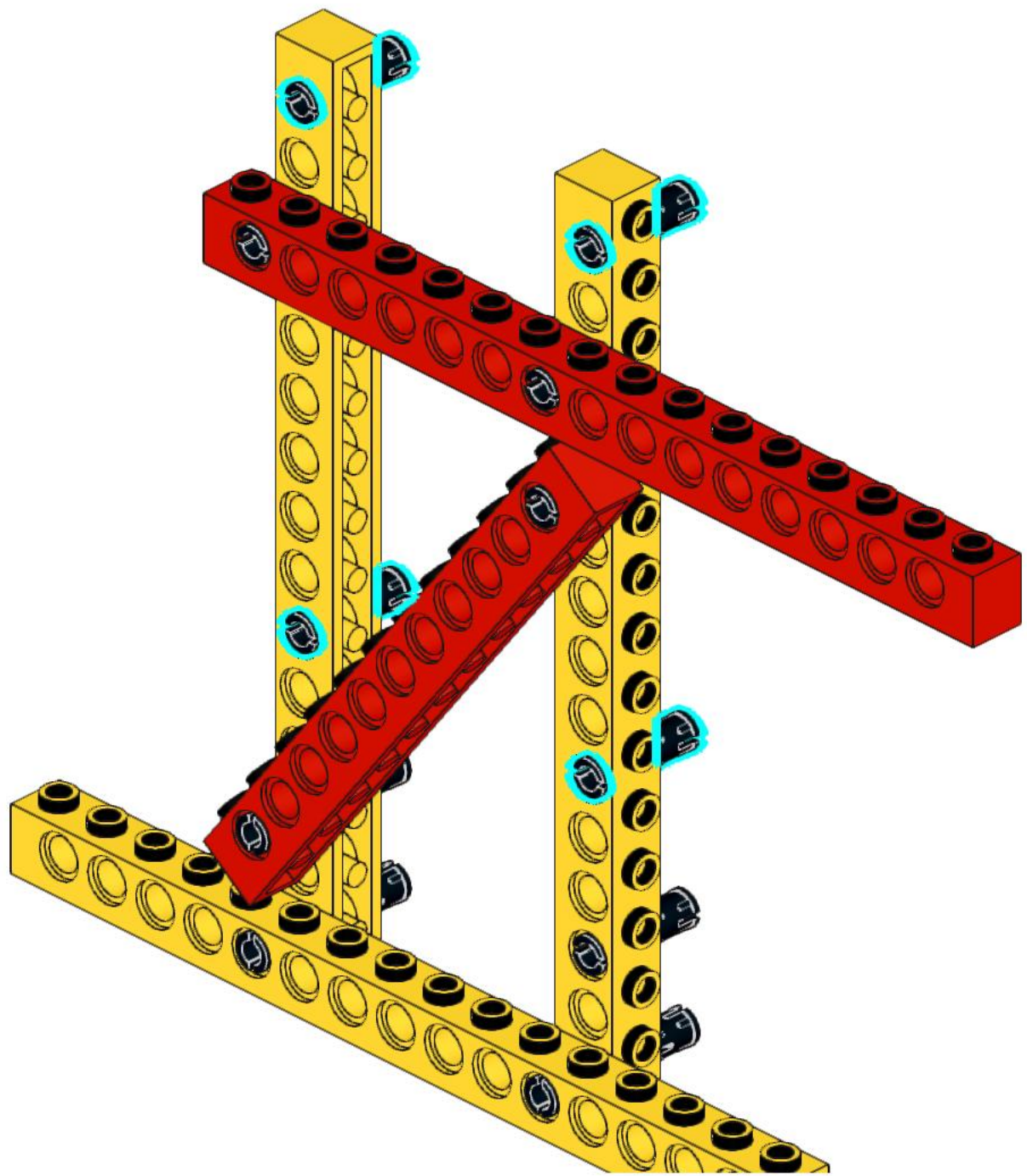

6

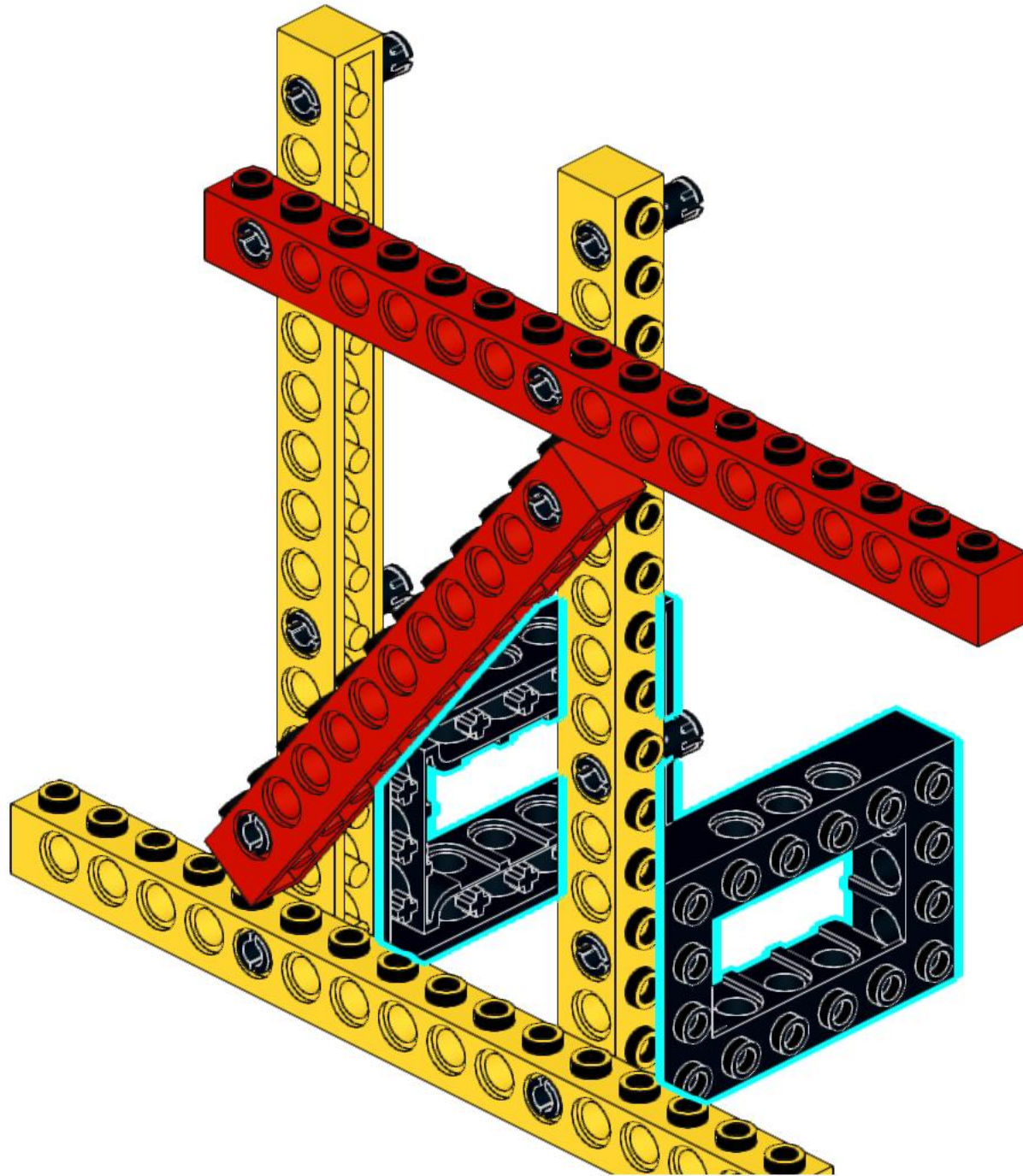
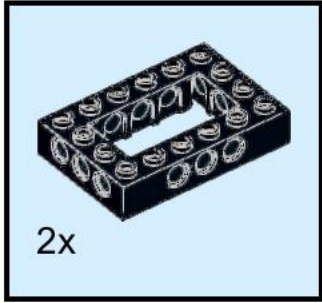

7

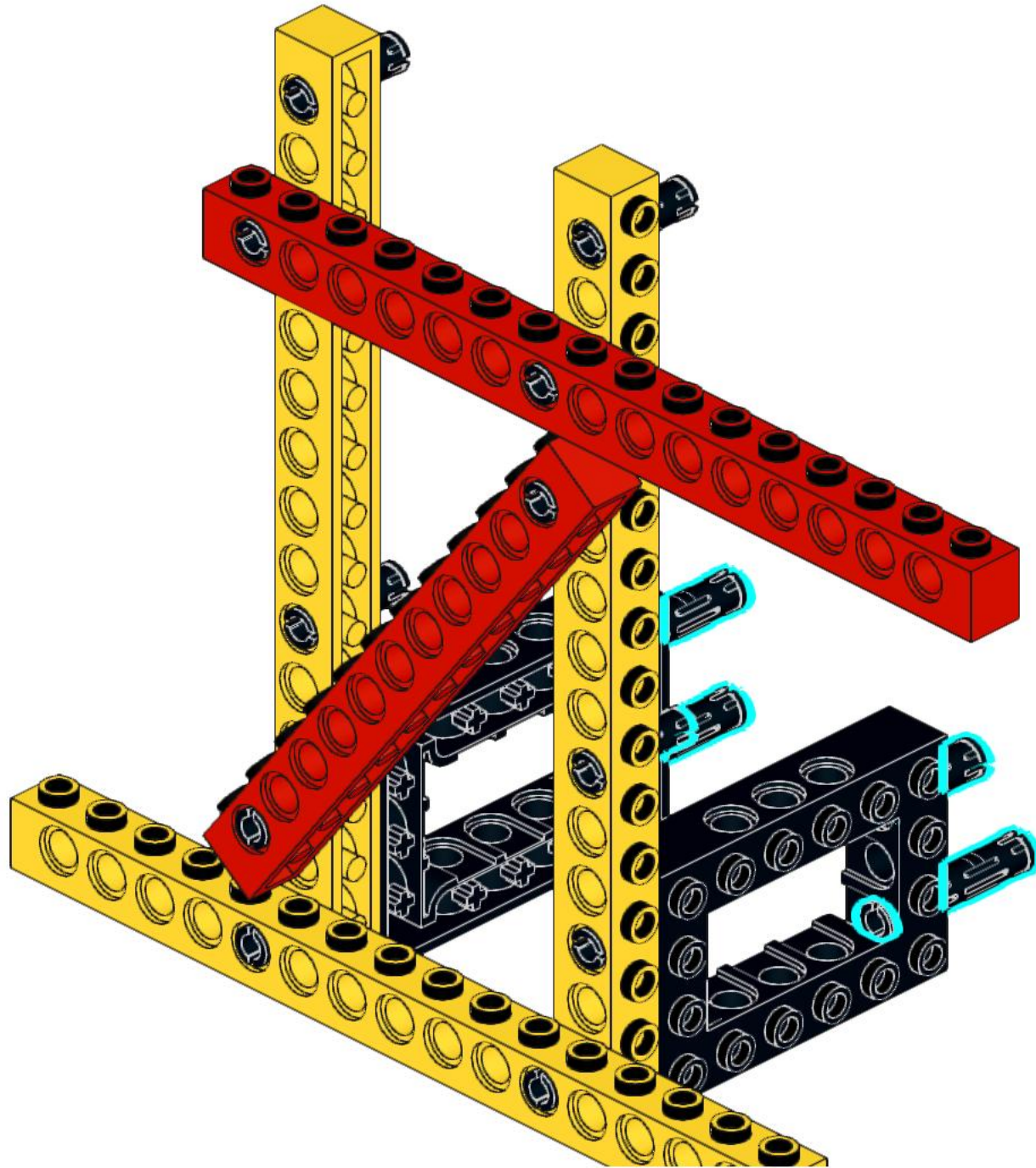
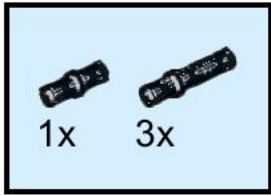

8

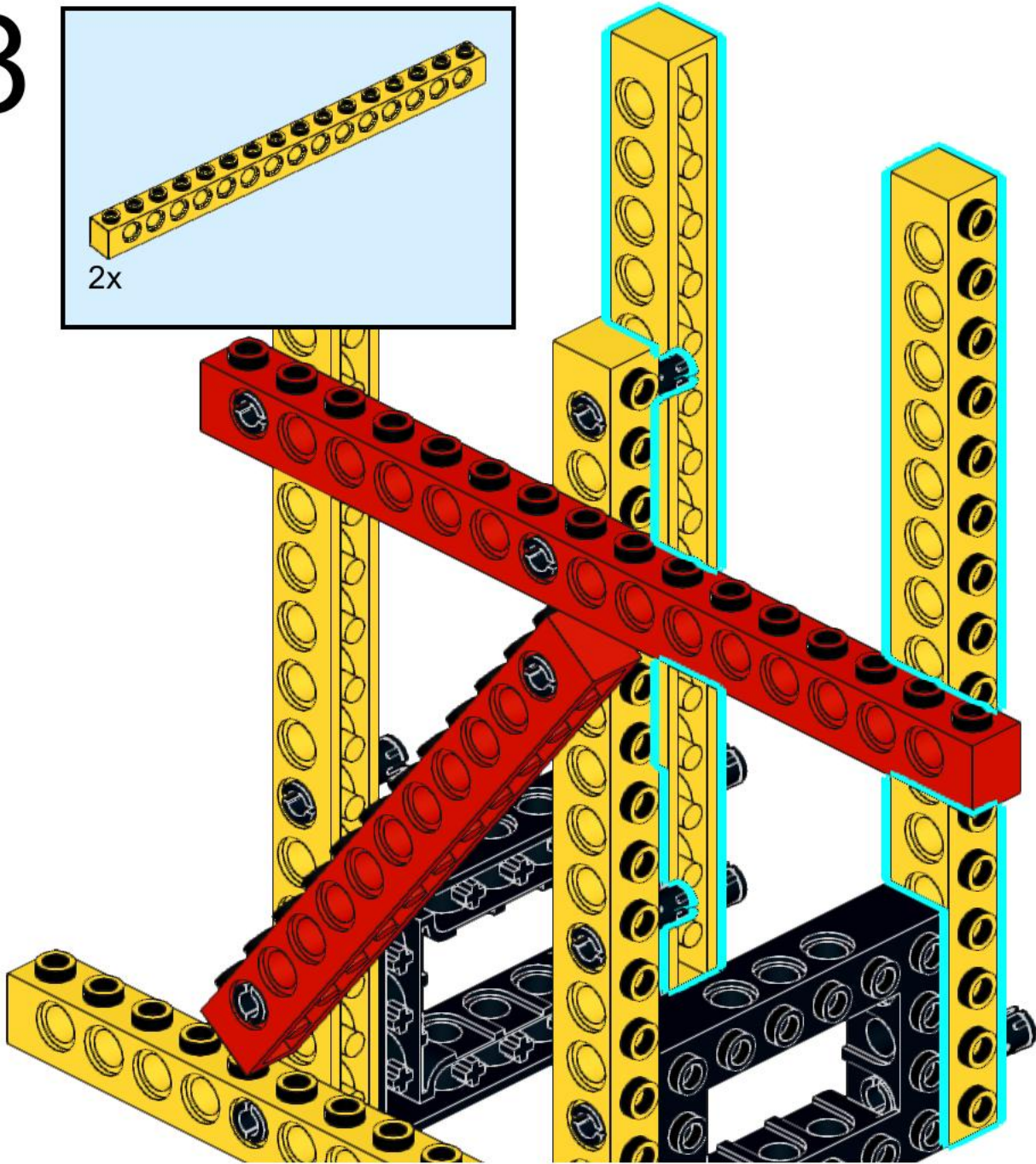
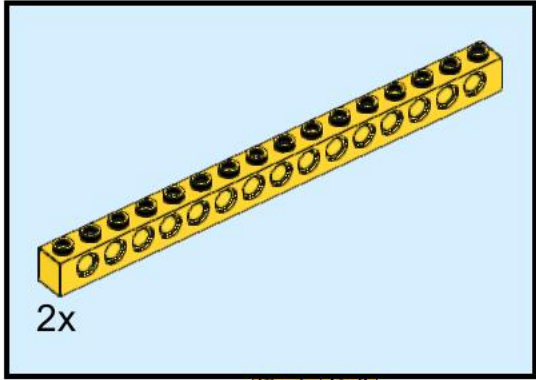

9

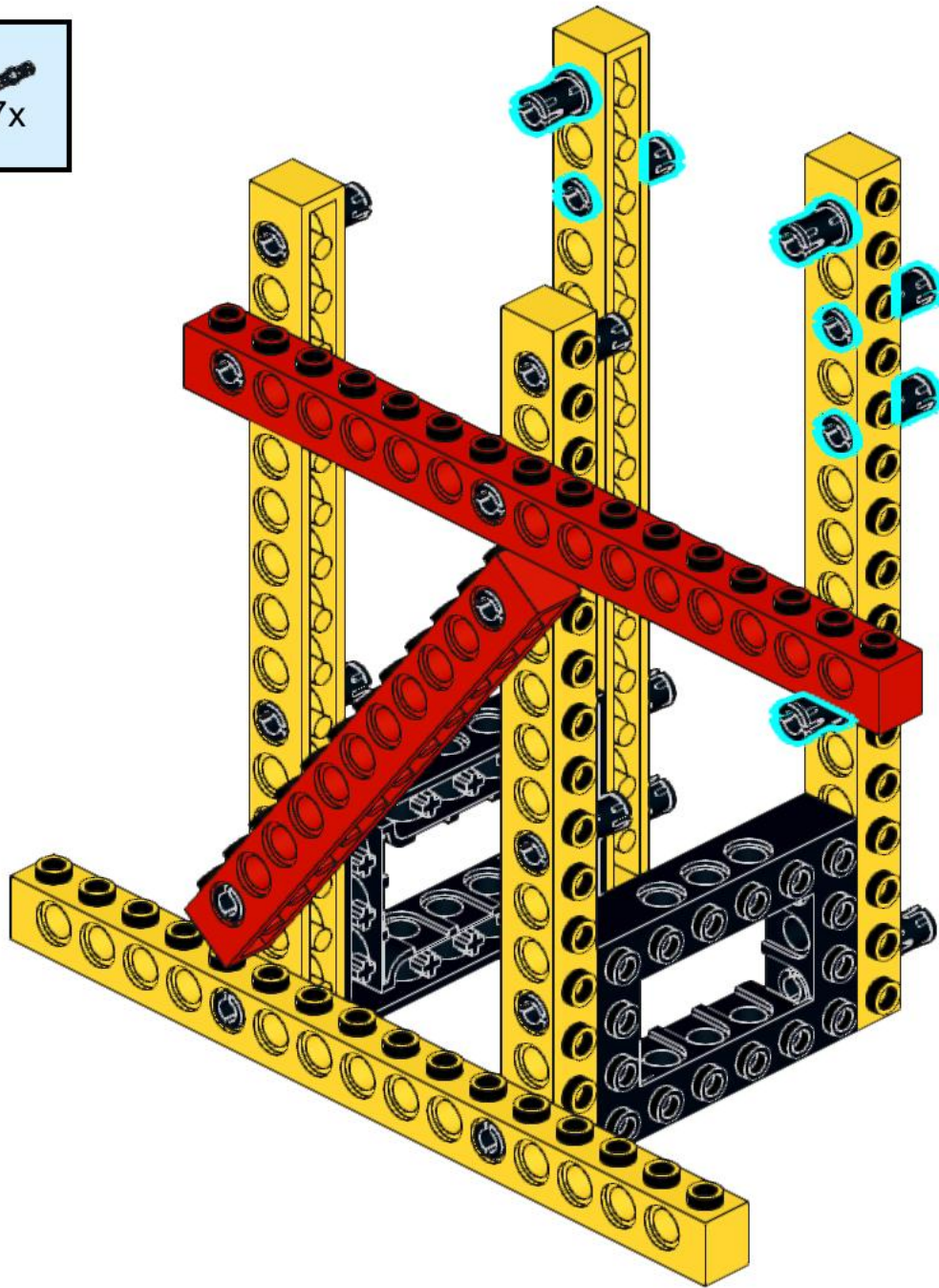

10

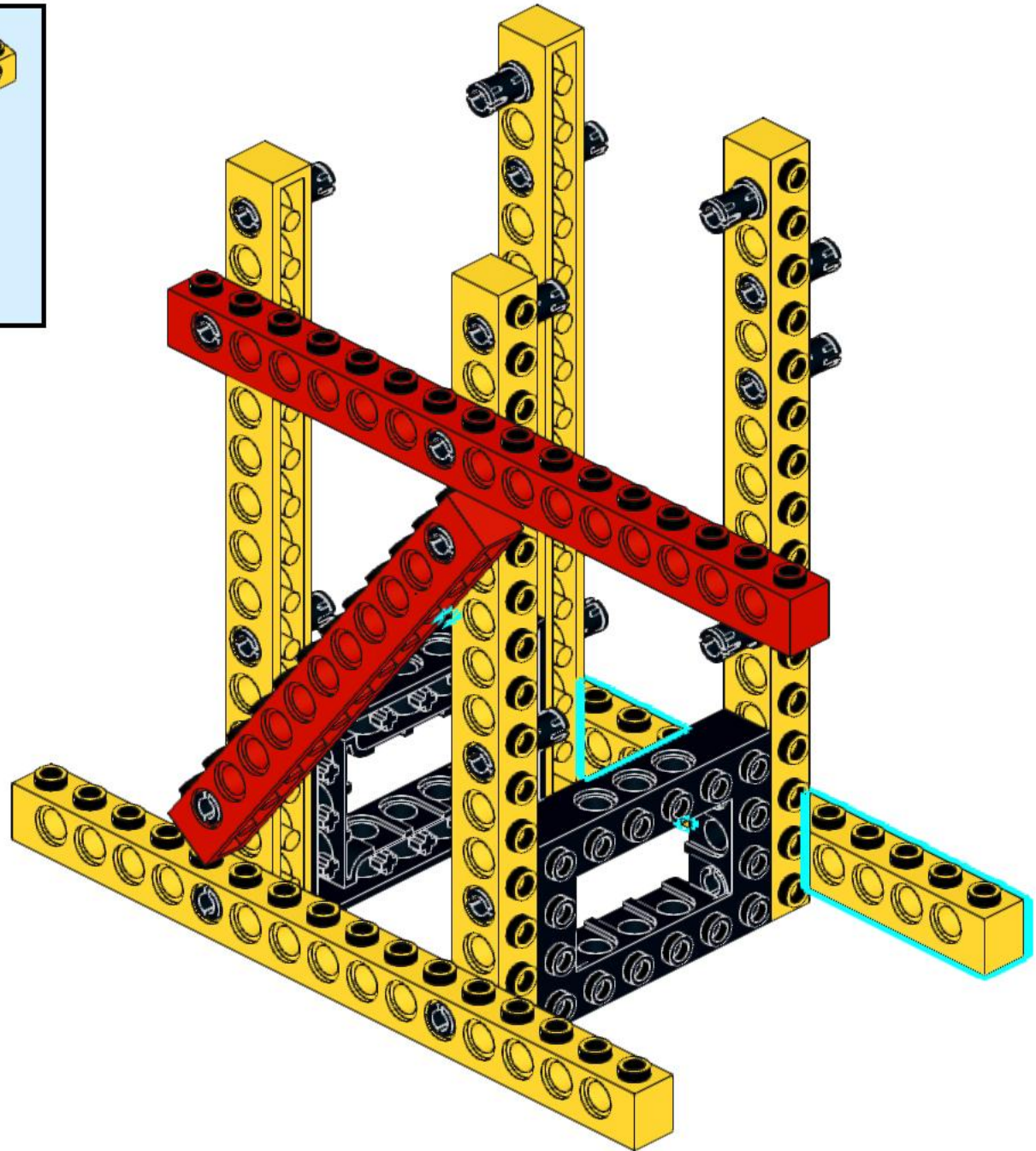
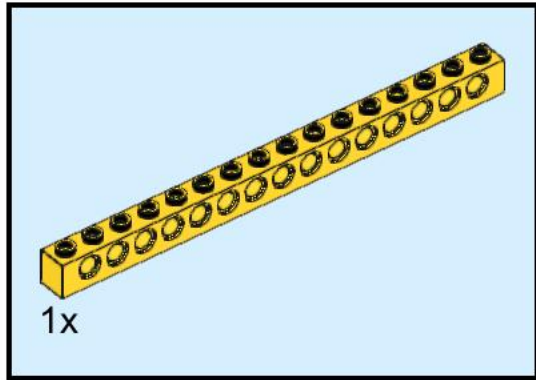

11

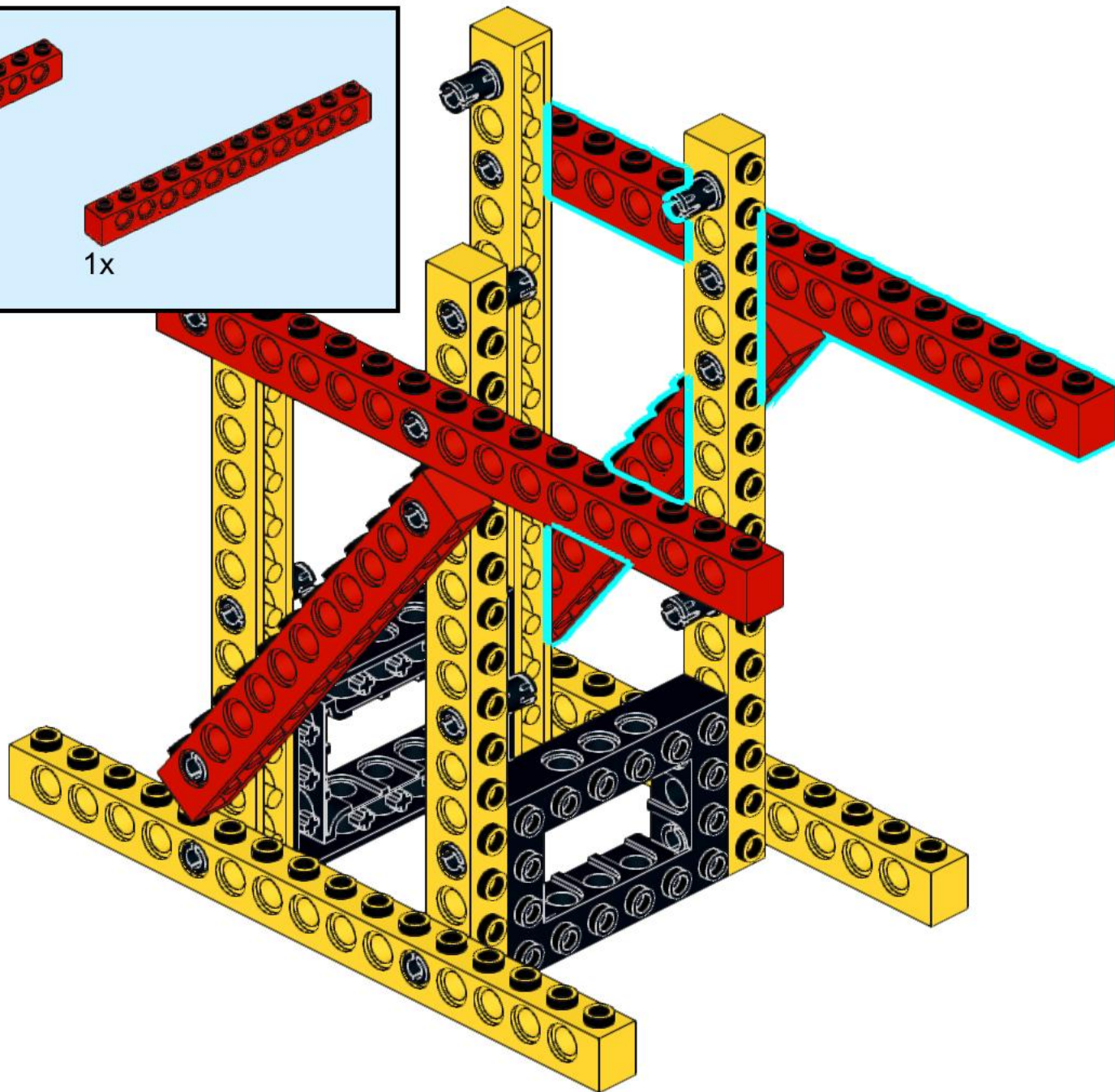
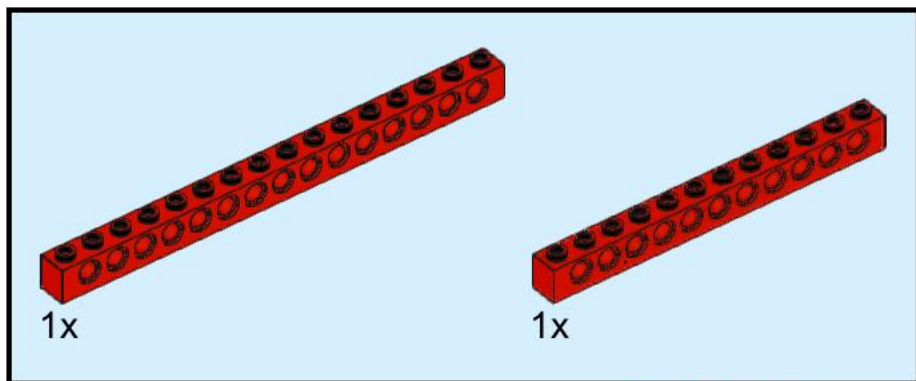

12

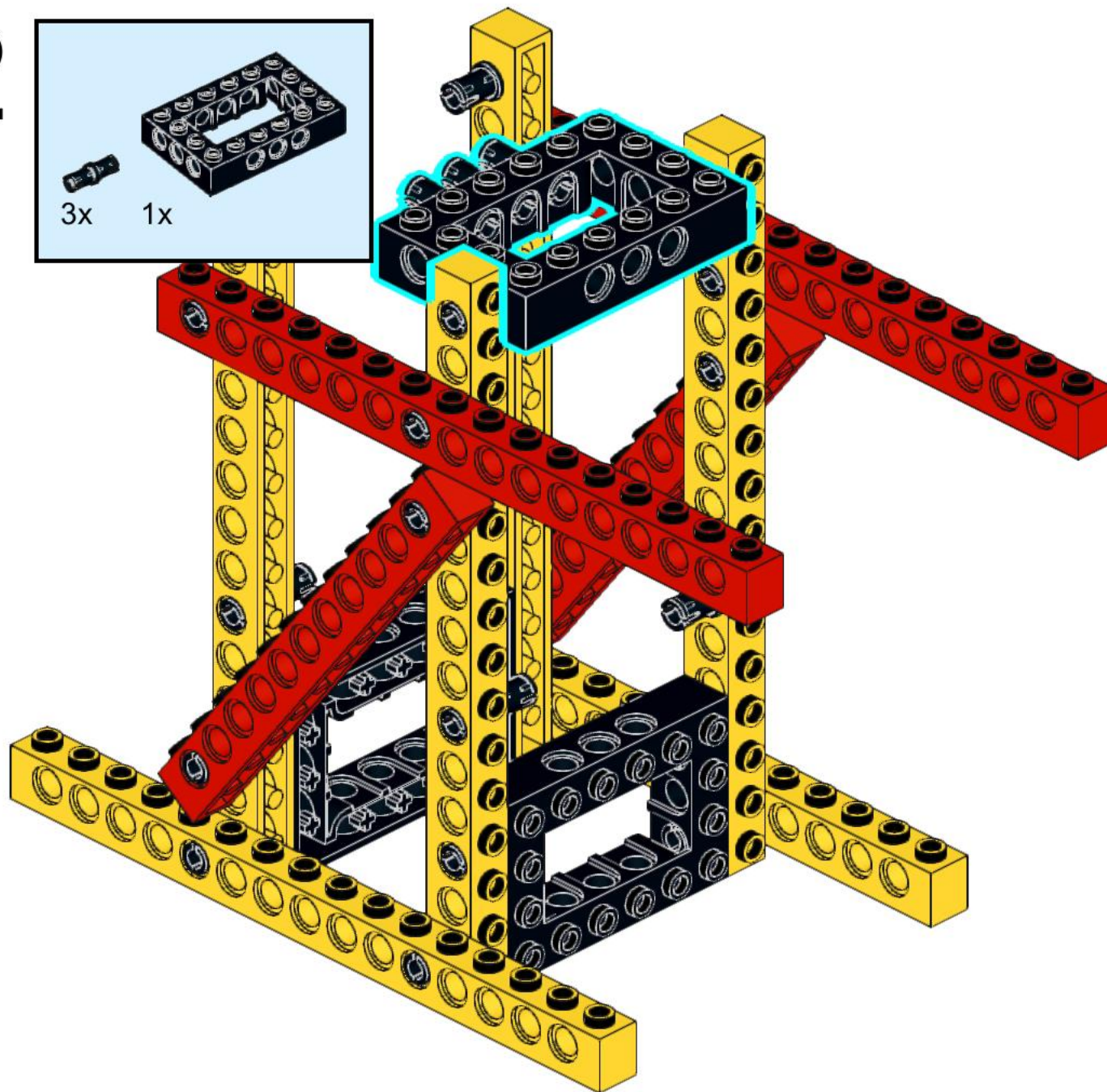
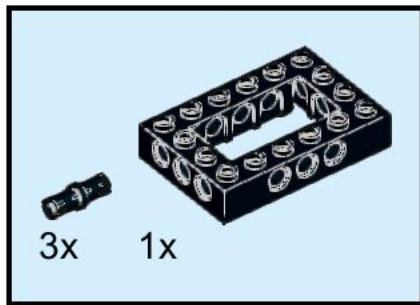

13

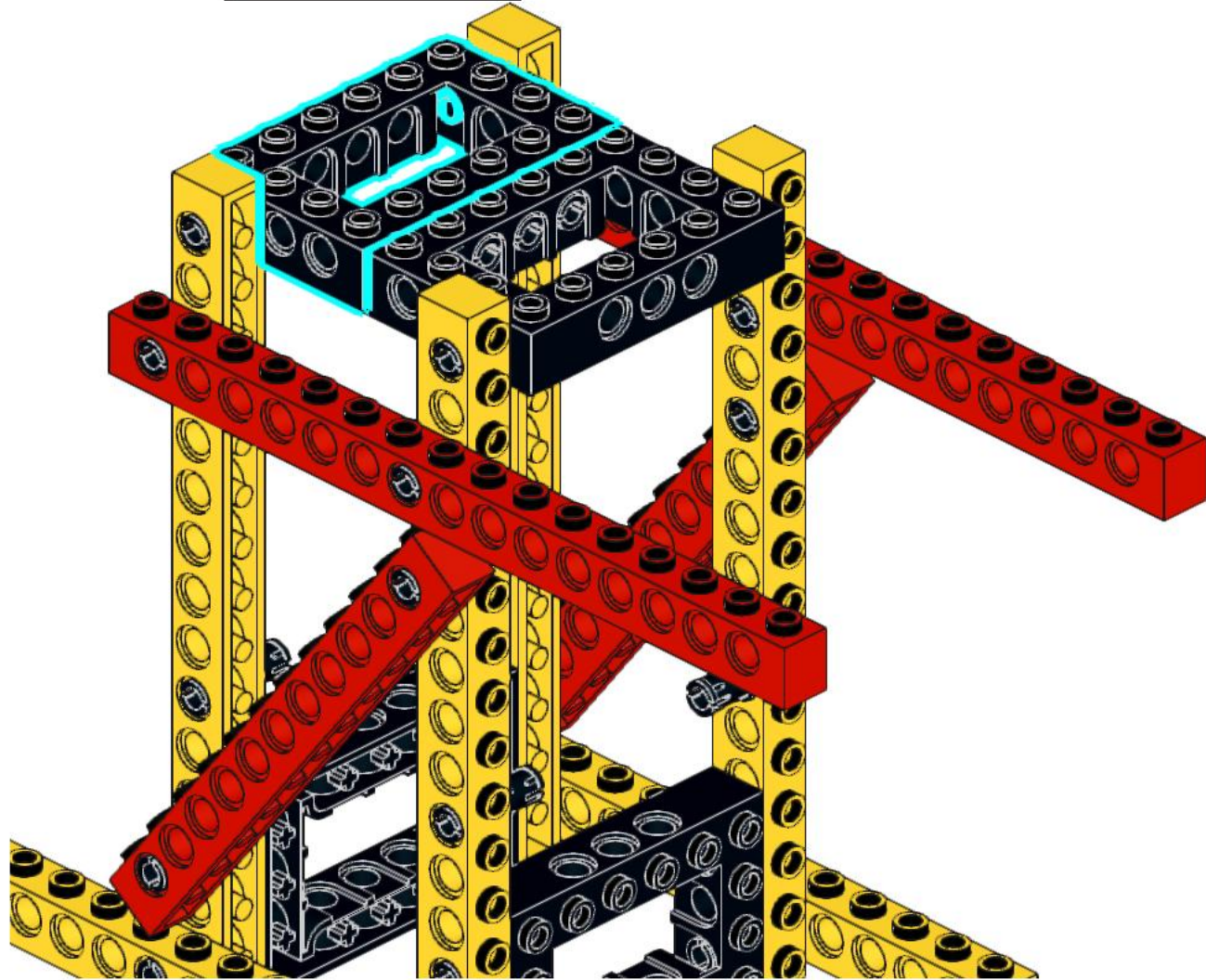
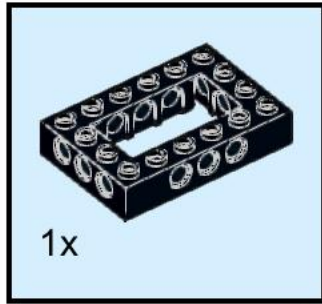

14

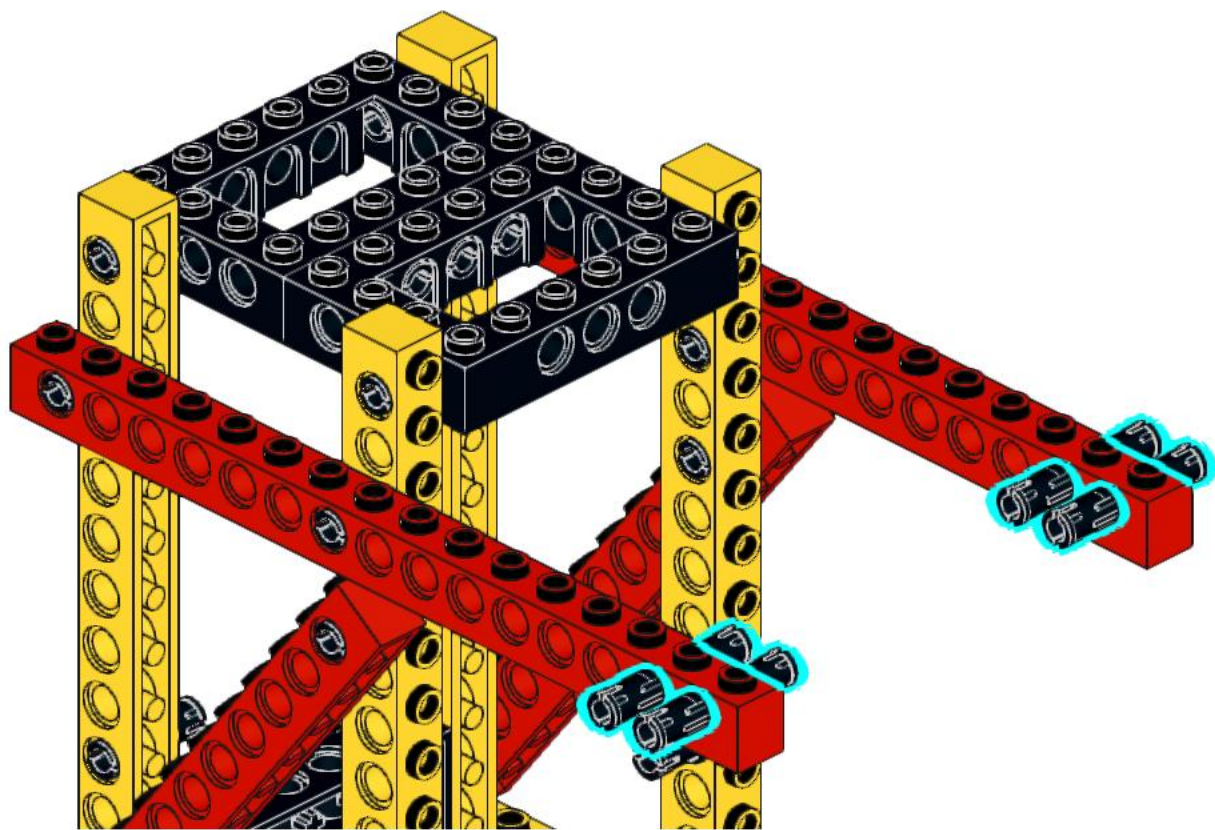

15

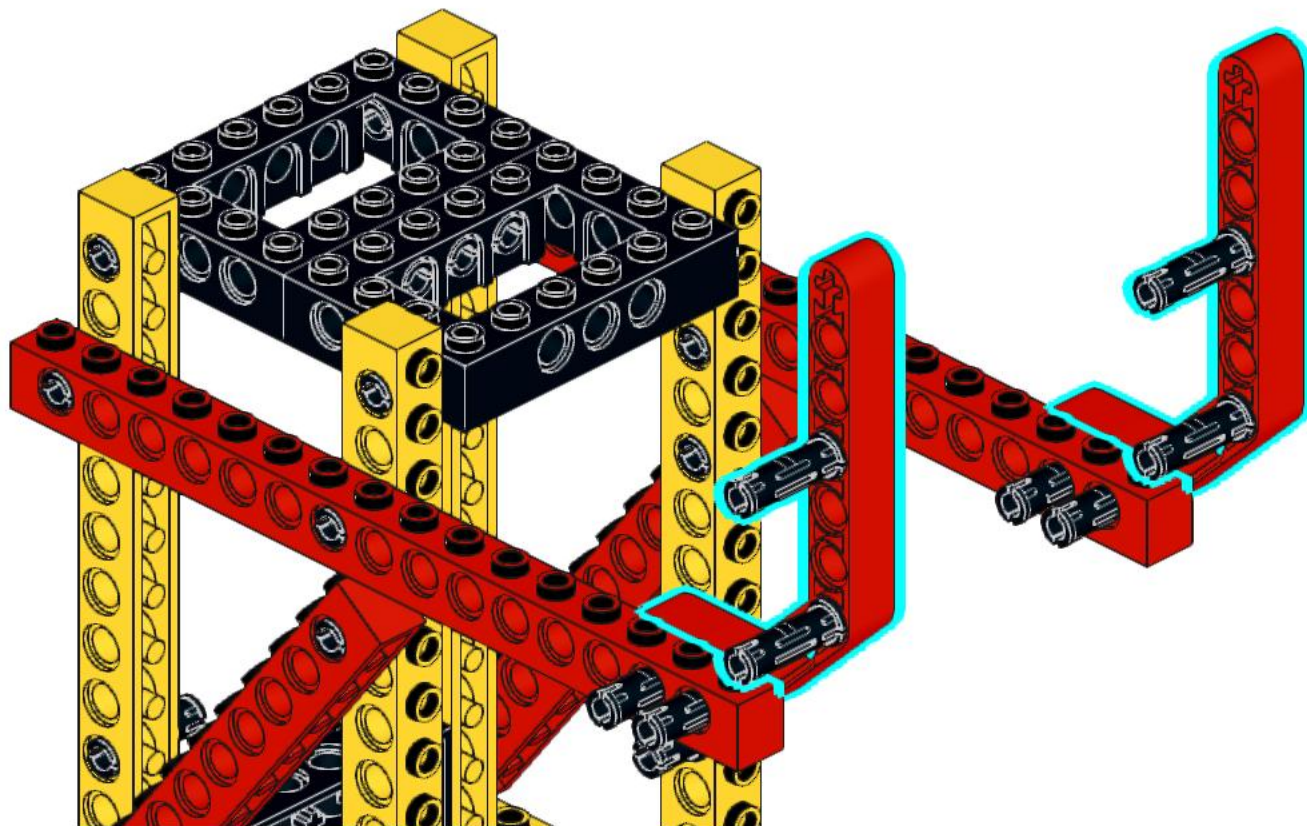
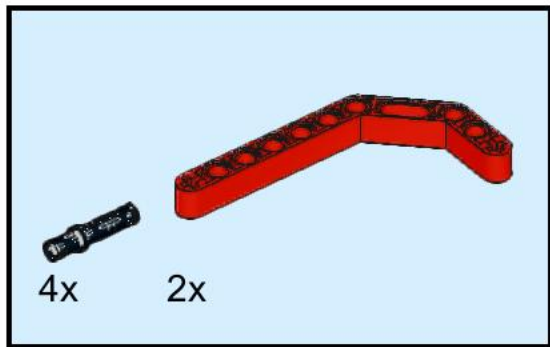

16

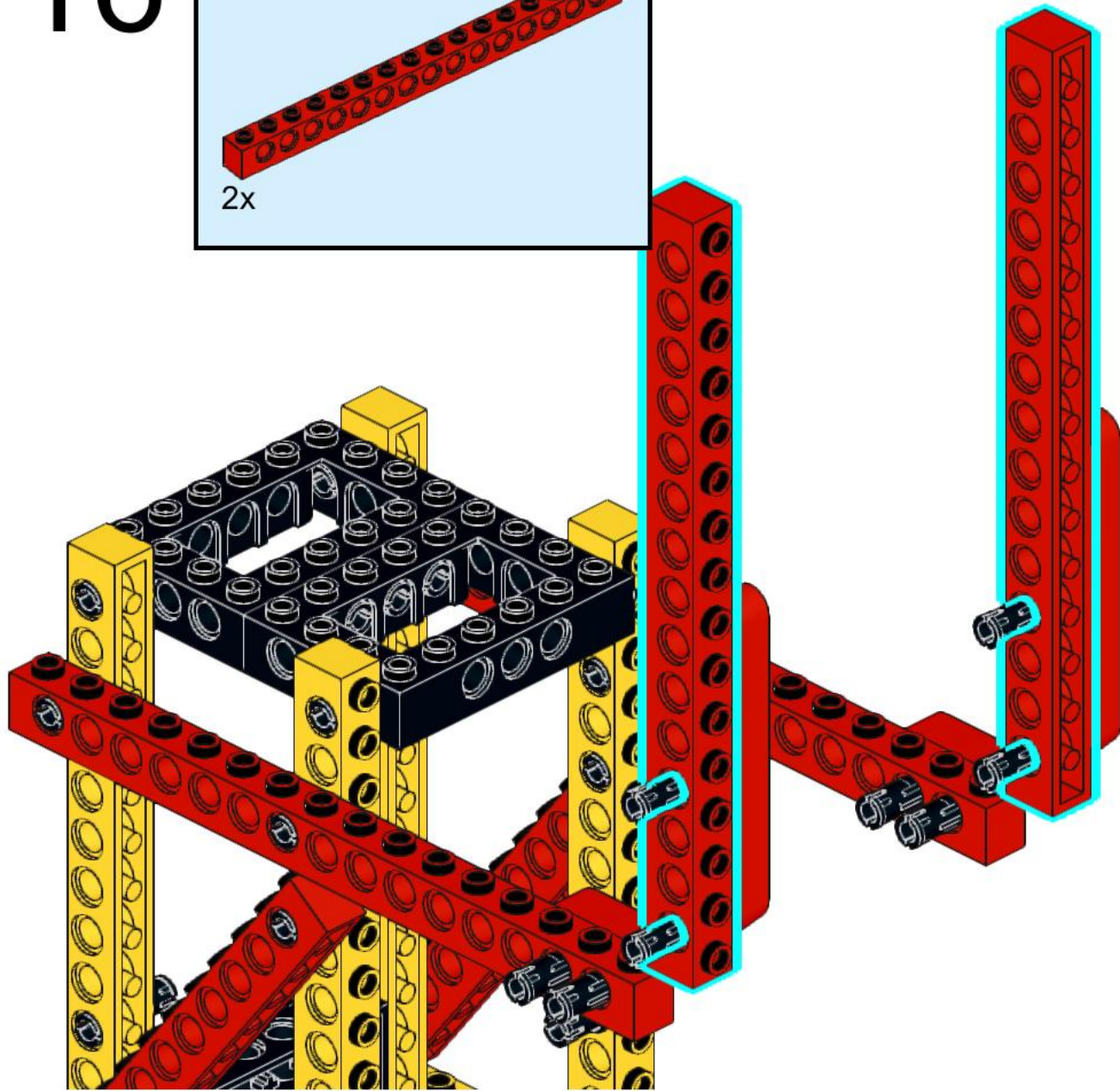
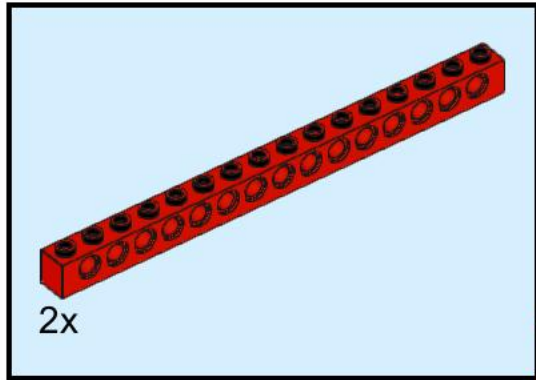

17

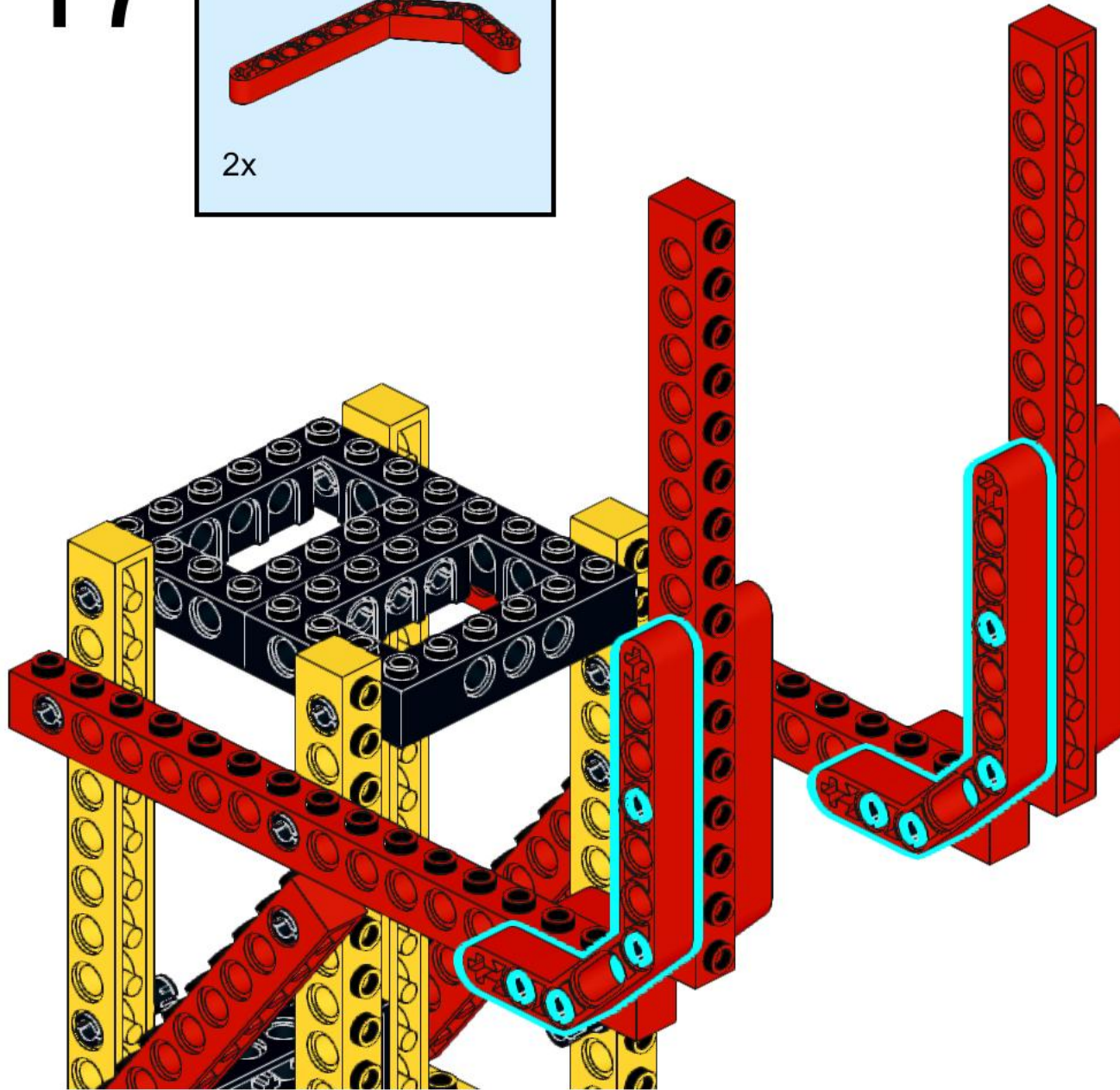
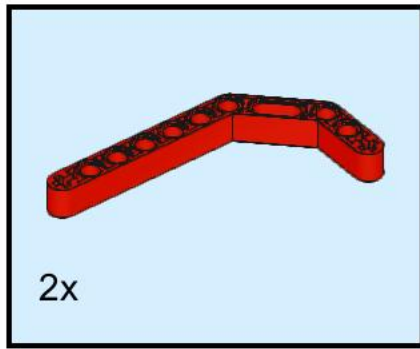

18

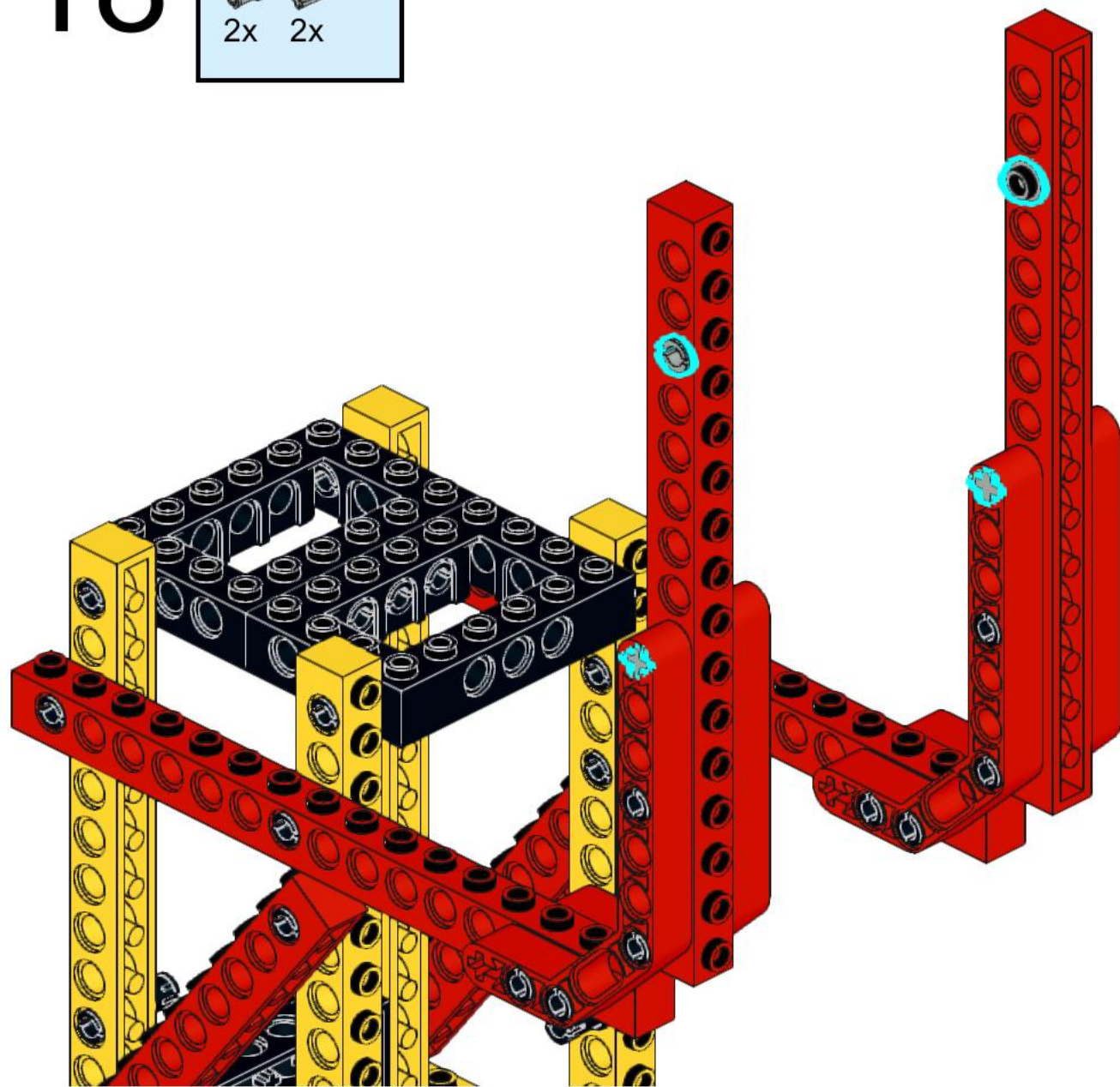
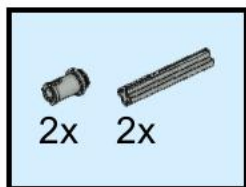

19

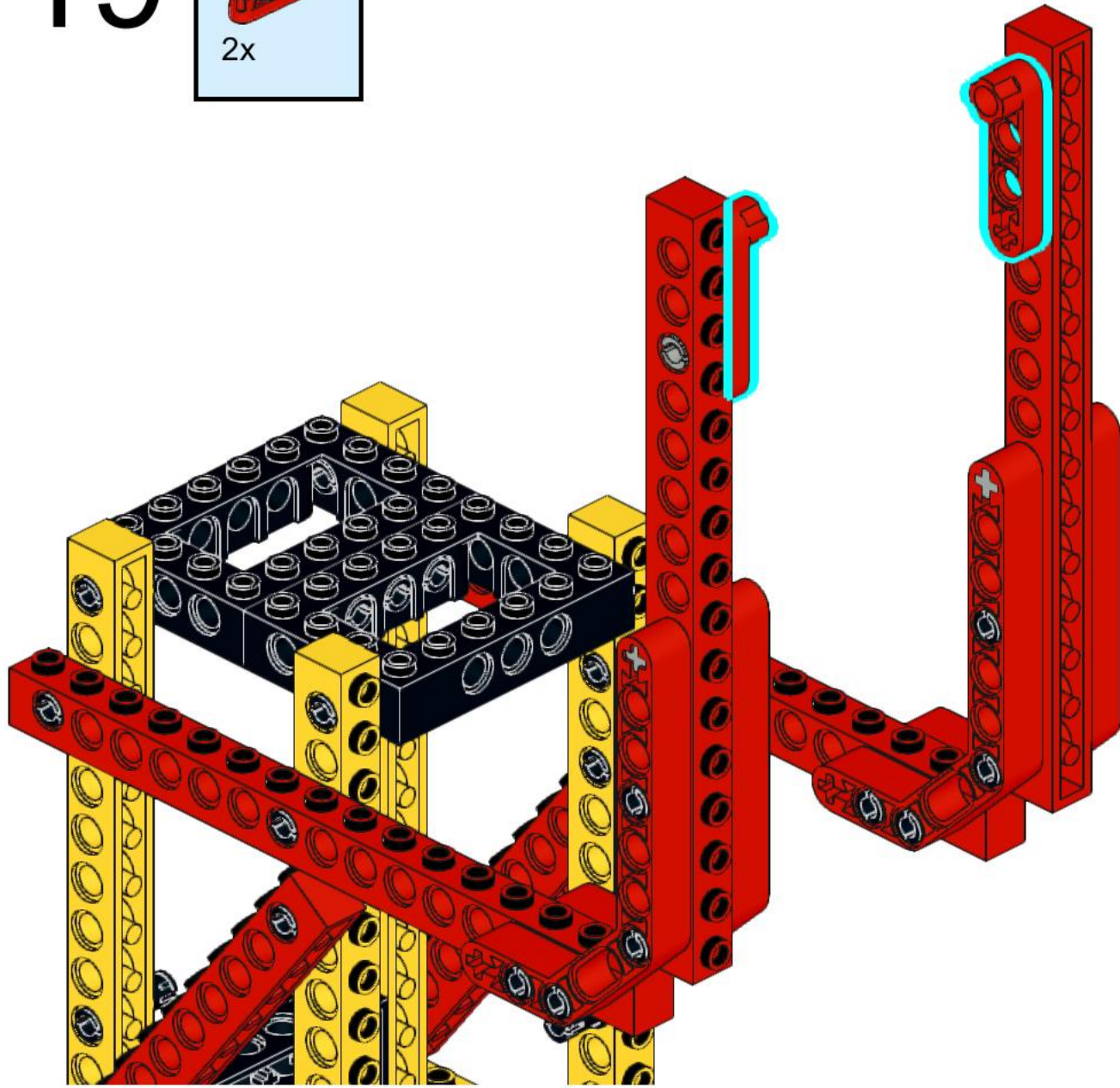
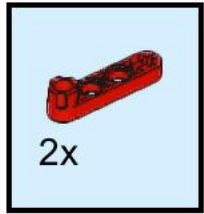

20

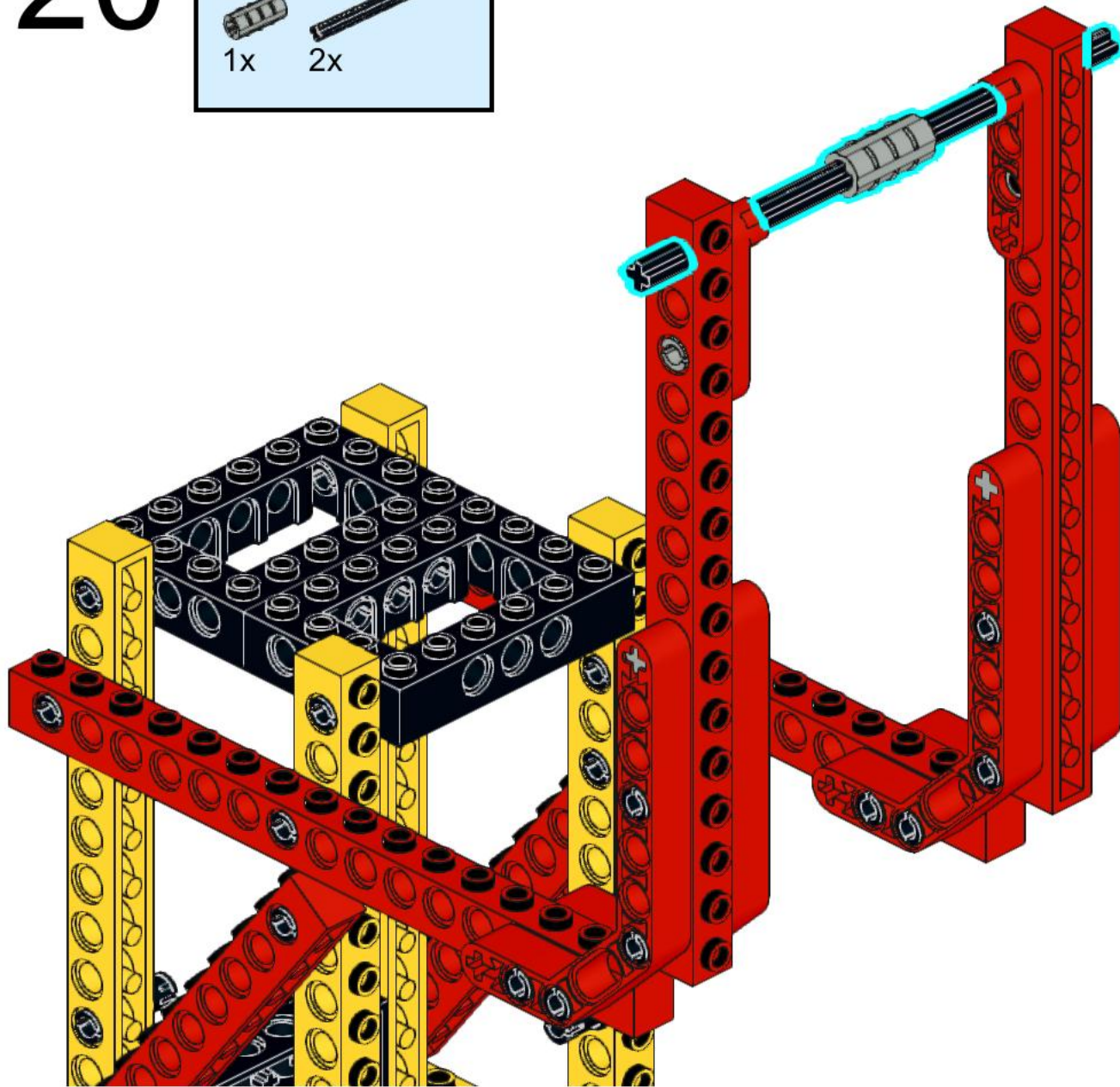
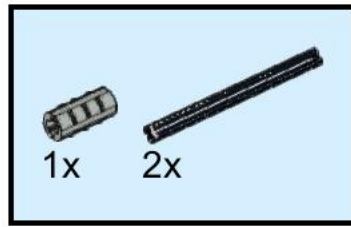

21

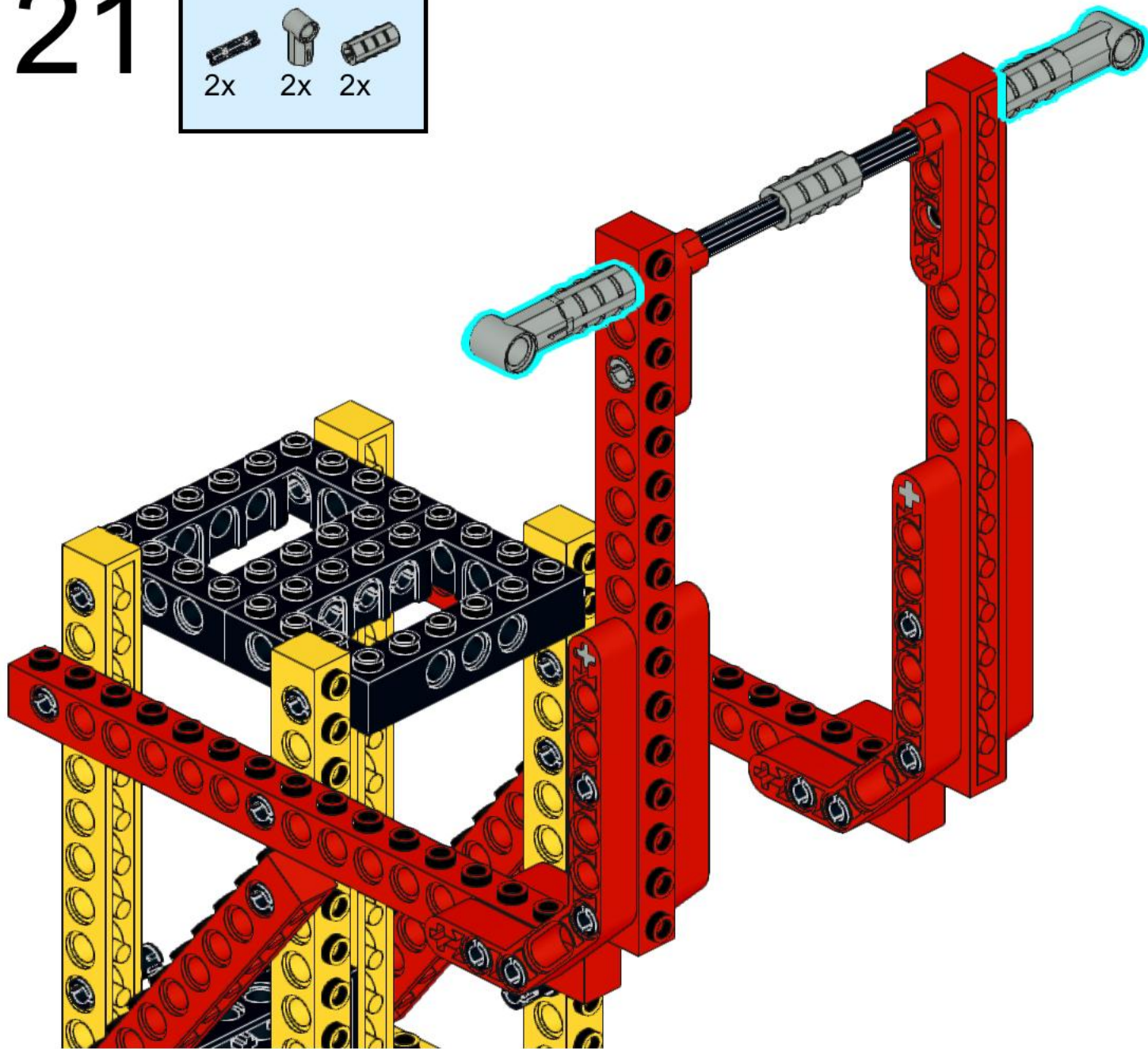
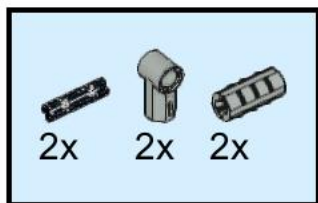

22

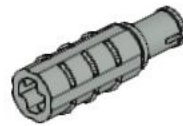
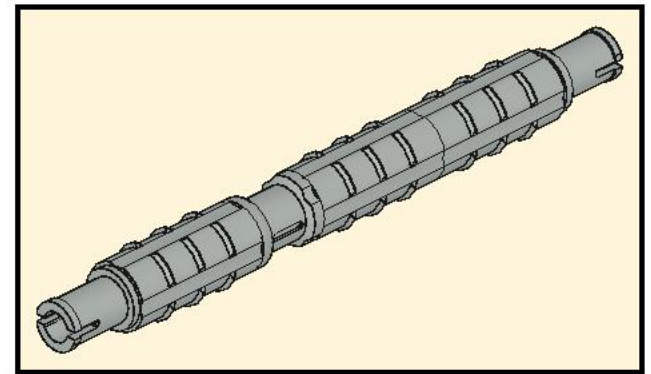
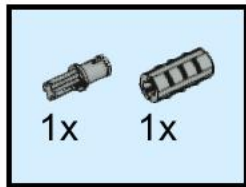

23

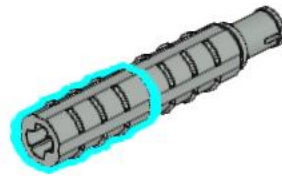
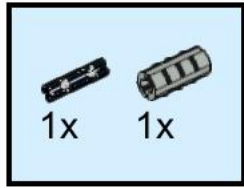

24

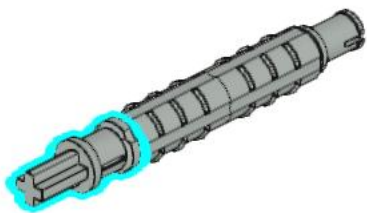
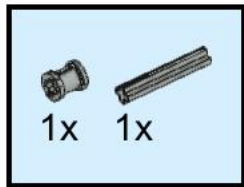

25

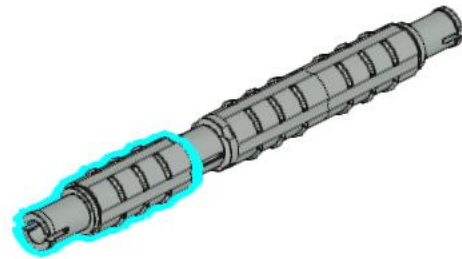
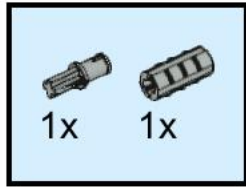

26

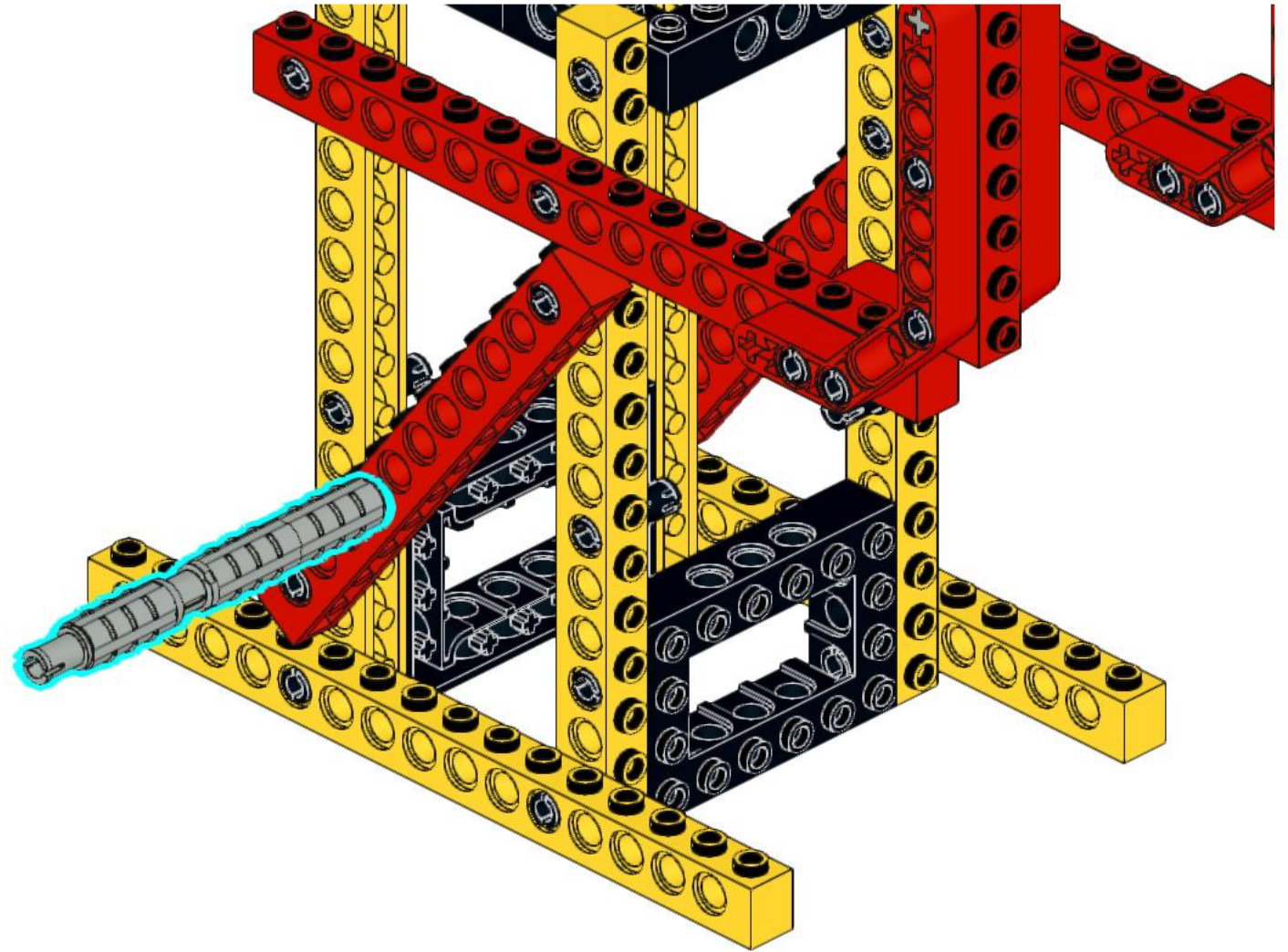

27

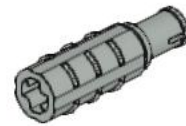
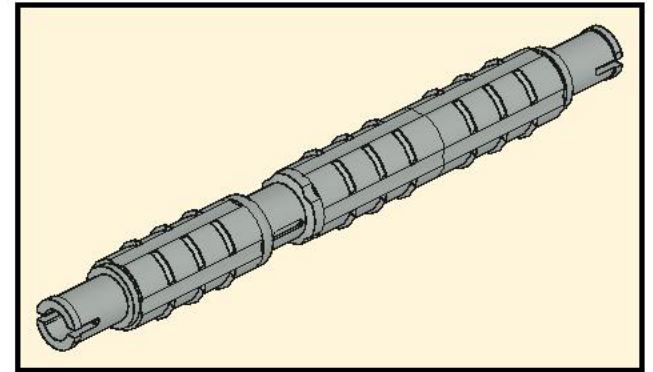
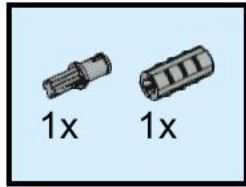

28

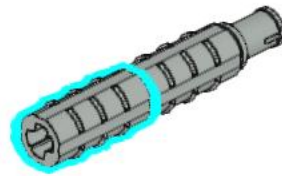
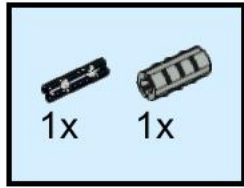

29

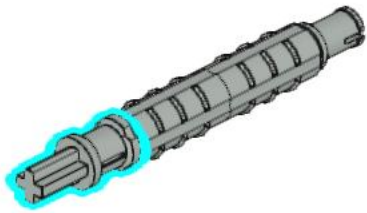
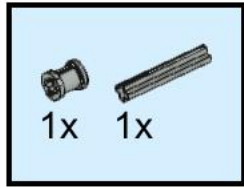

30

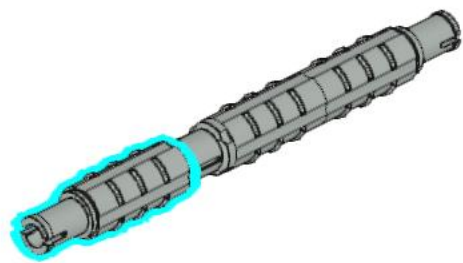
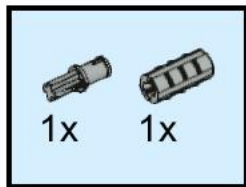

31

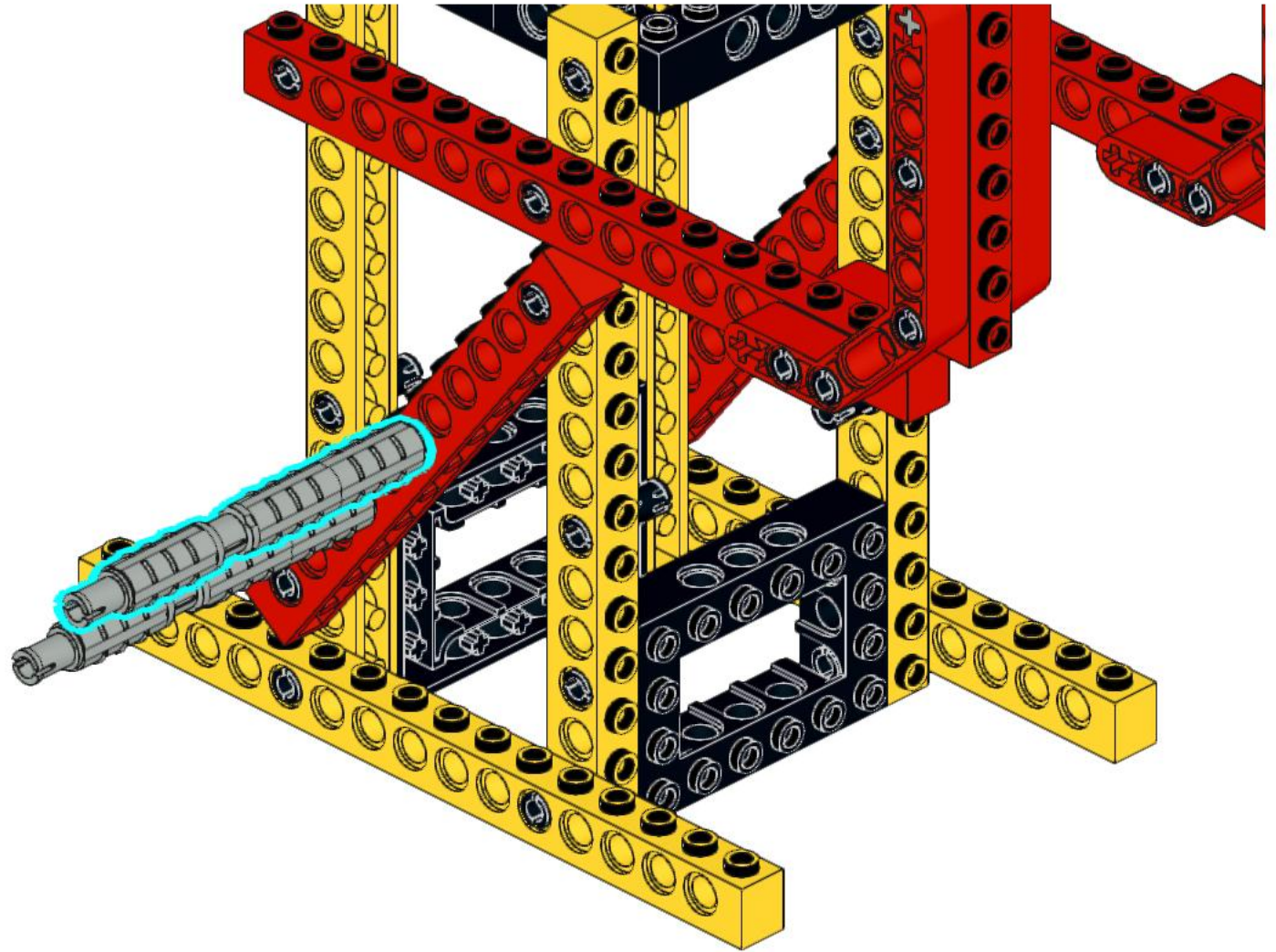

32

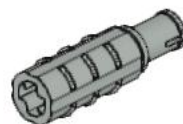
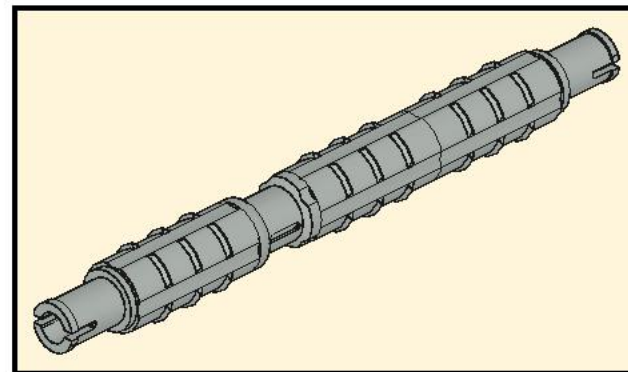
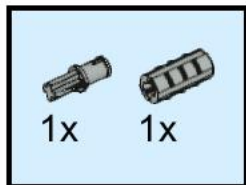

33

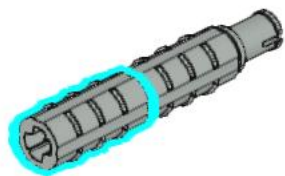
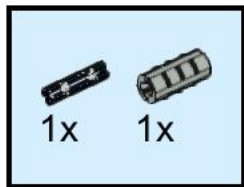

34

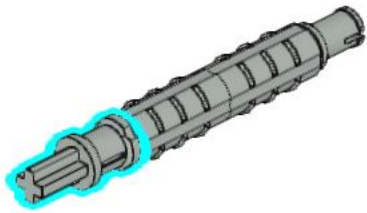
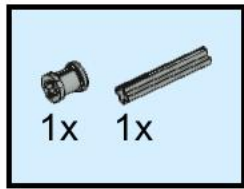

35

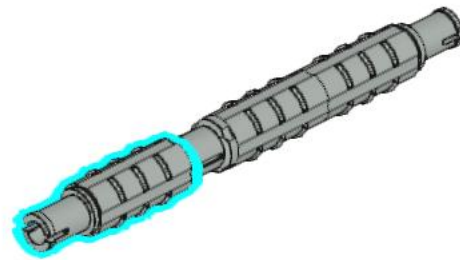
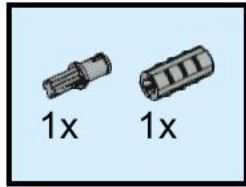

36

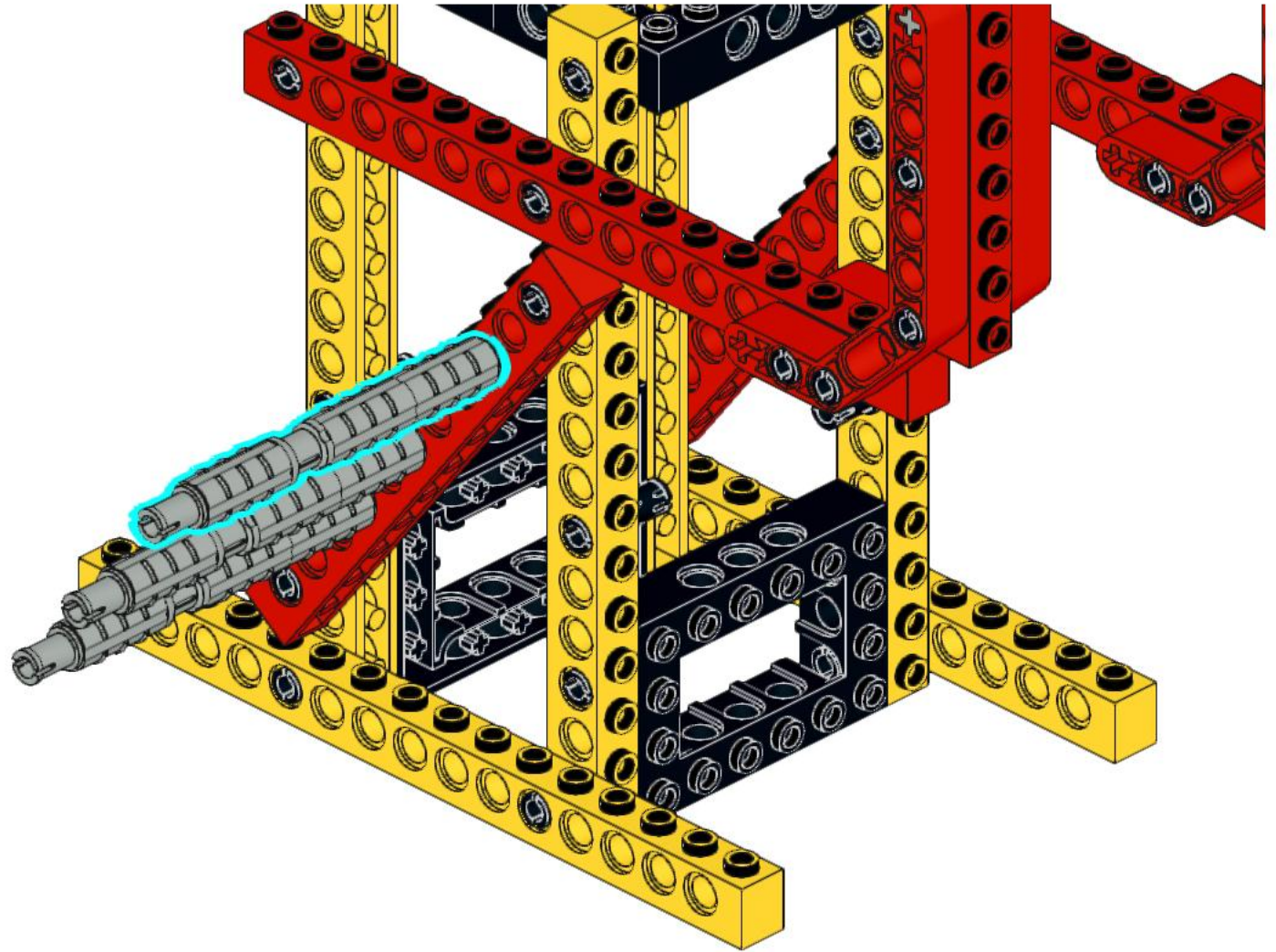

37

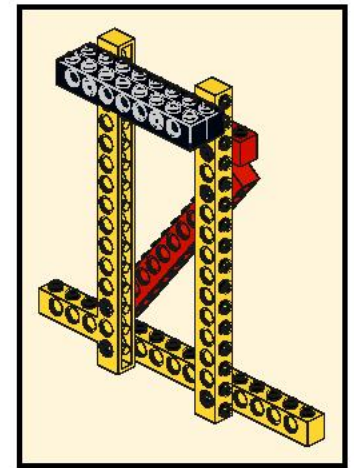
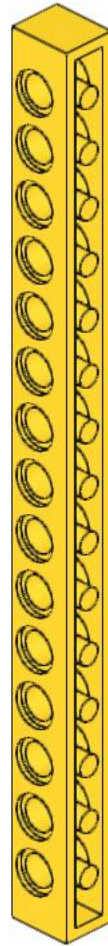
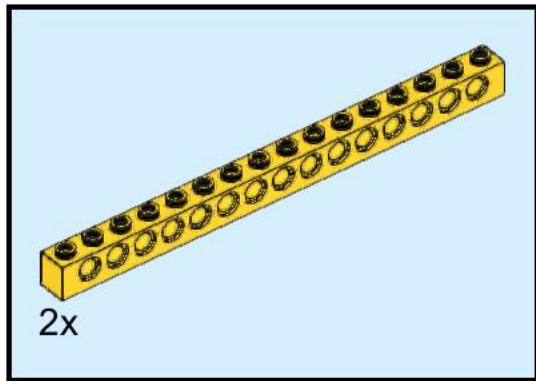

38

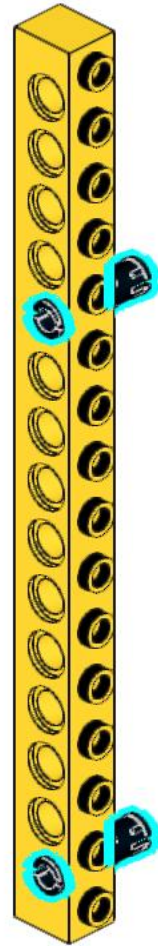
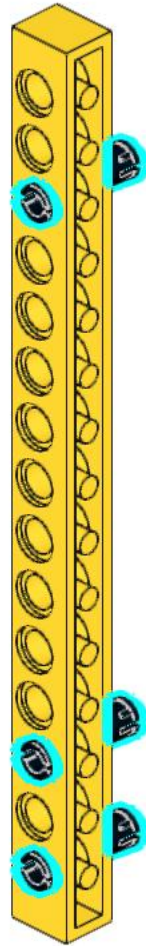

39

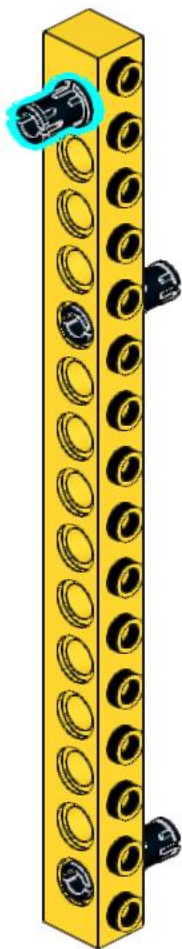
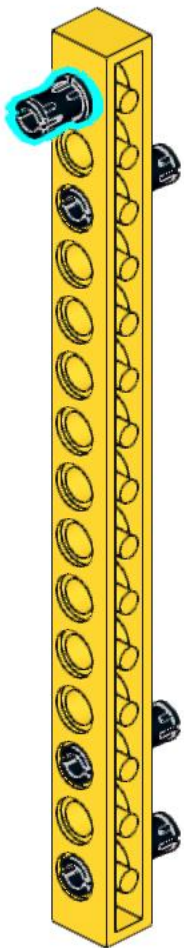

40

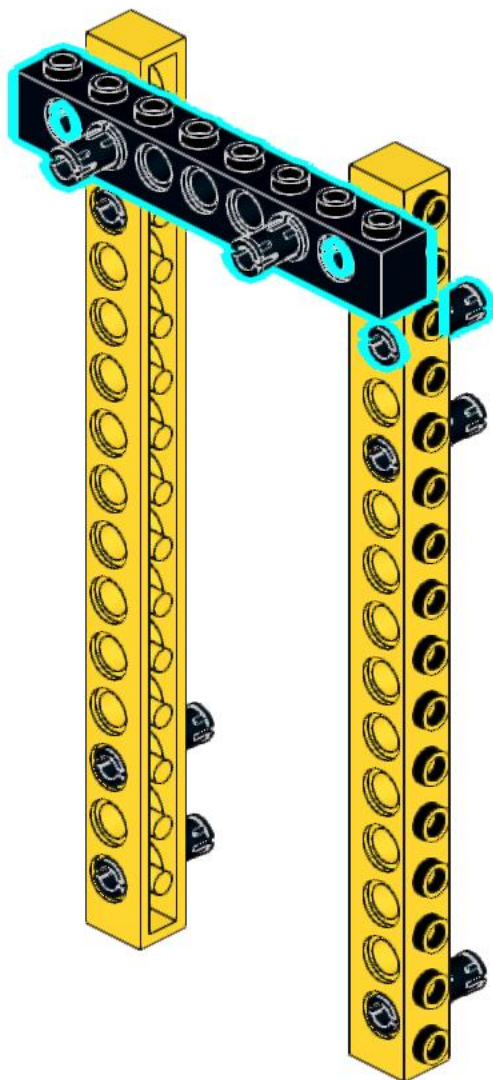
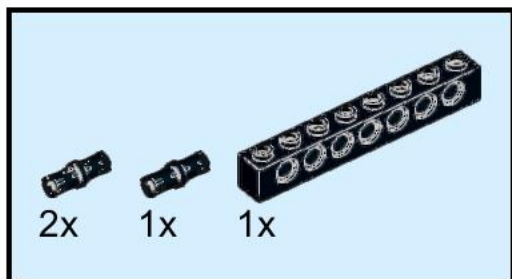

41

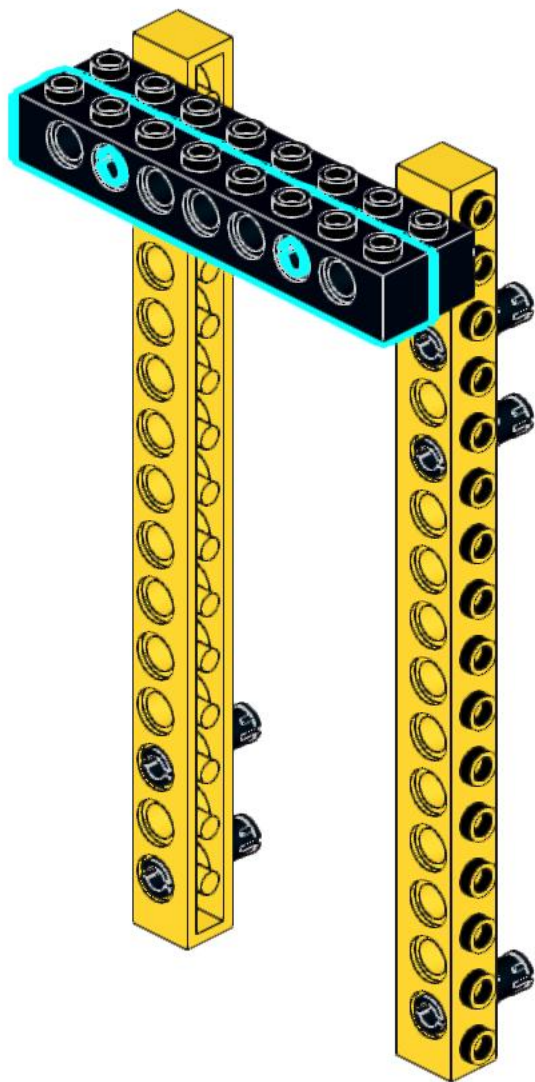
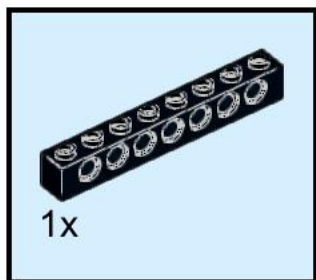

42

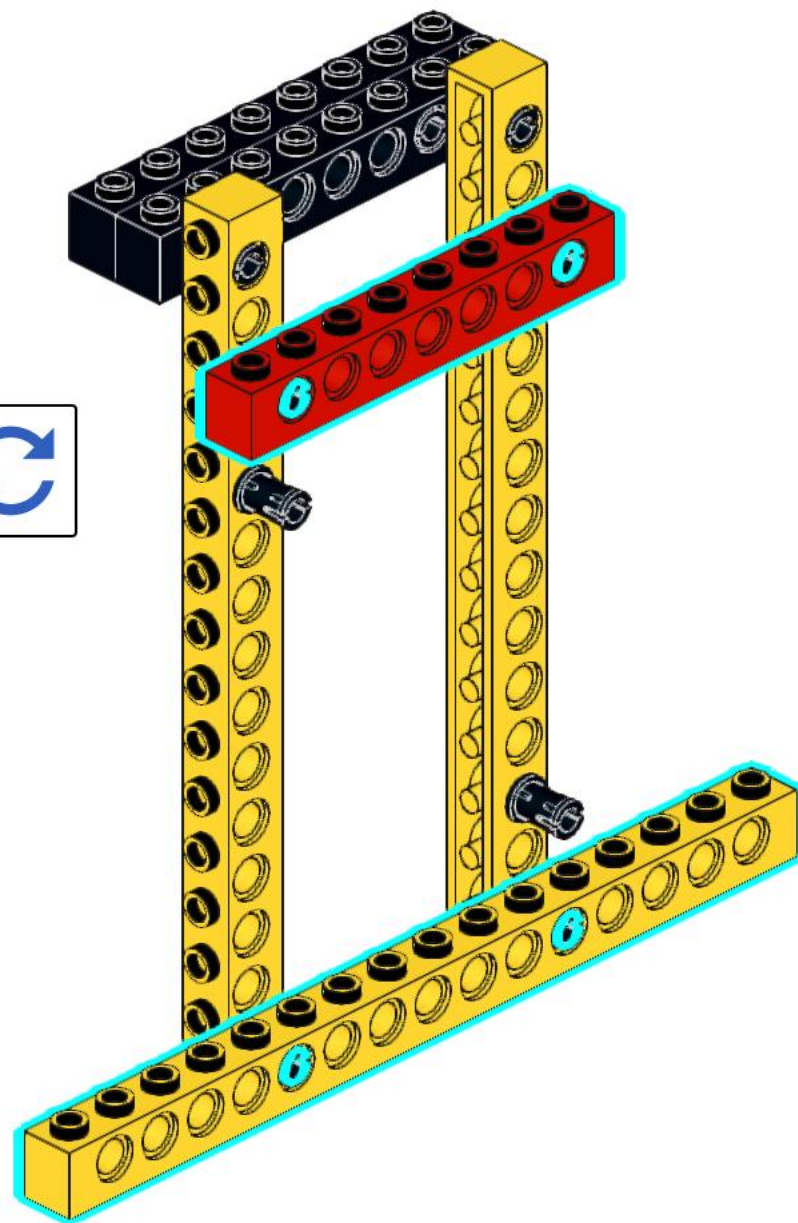
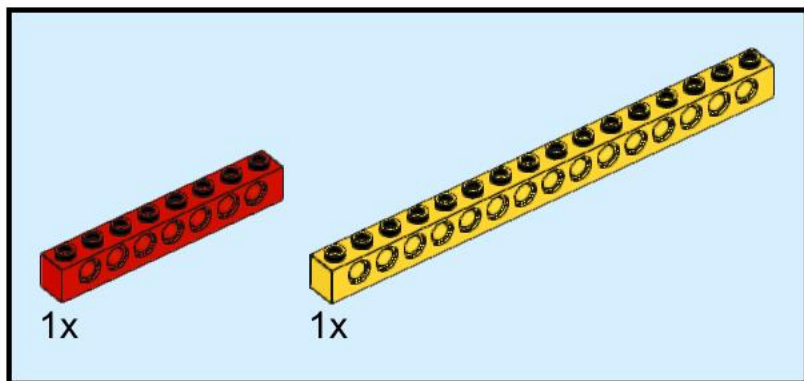

43

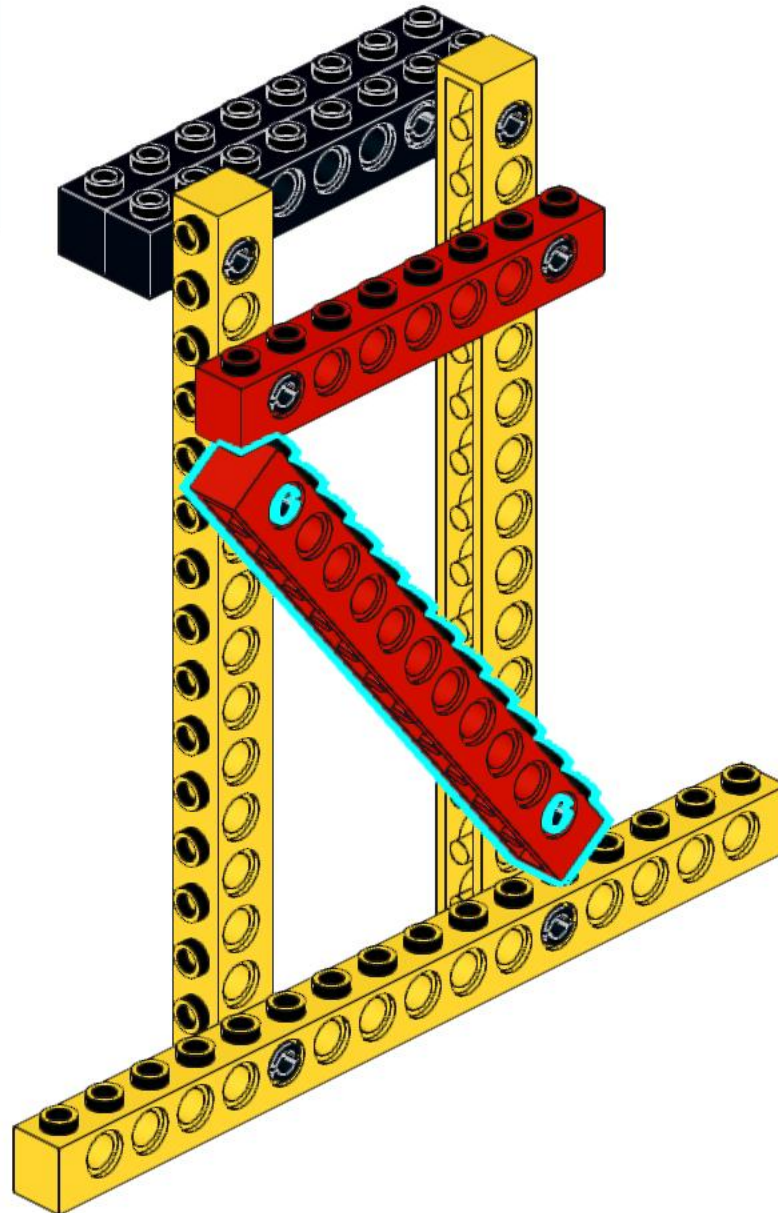
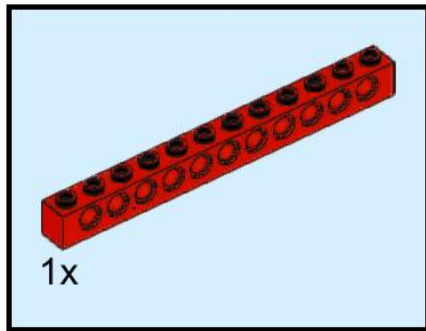

44

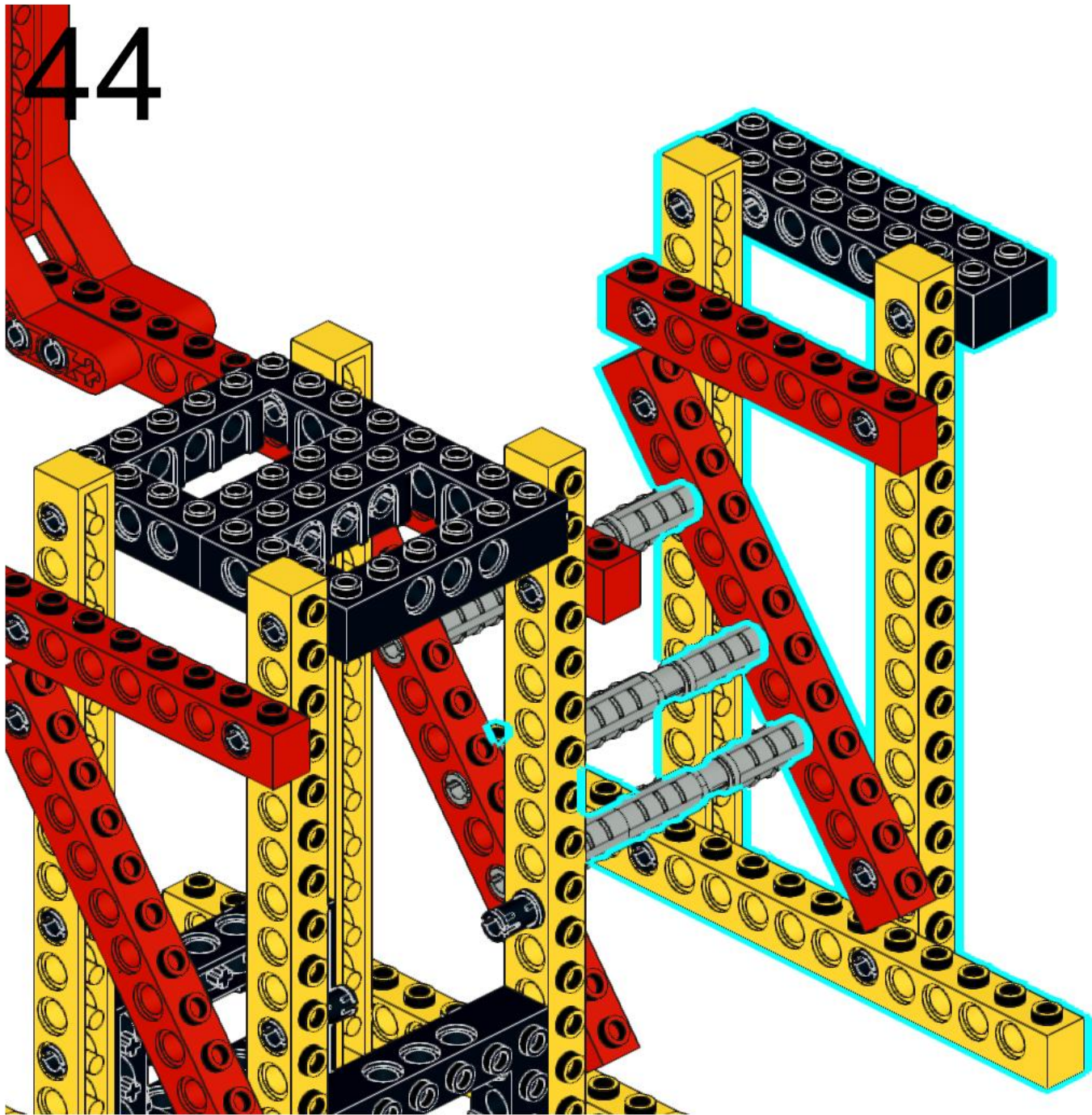

45

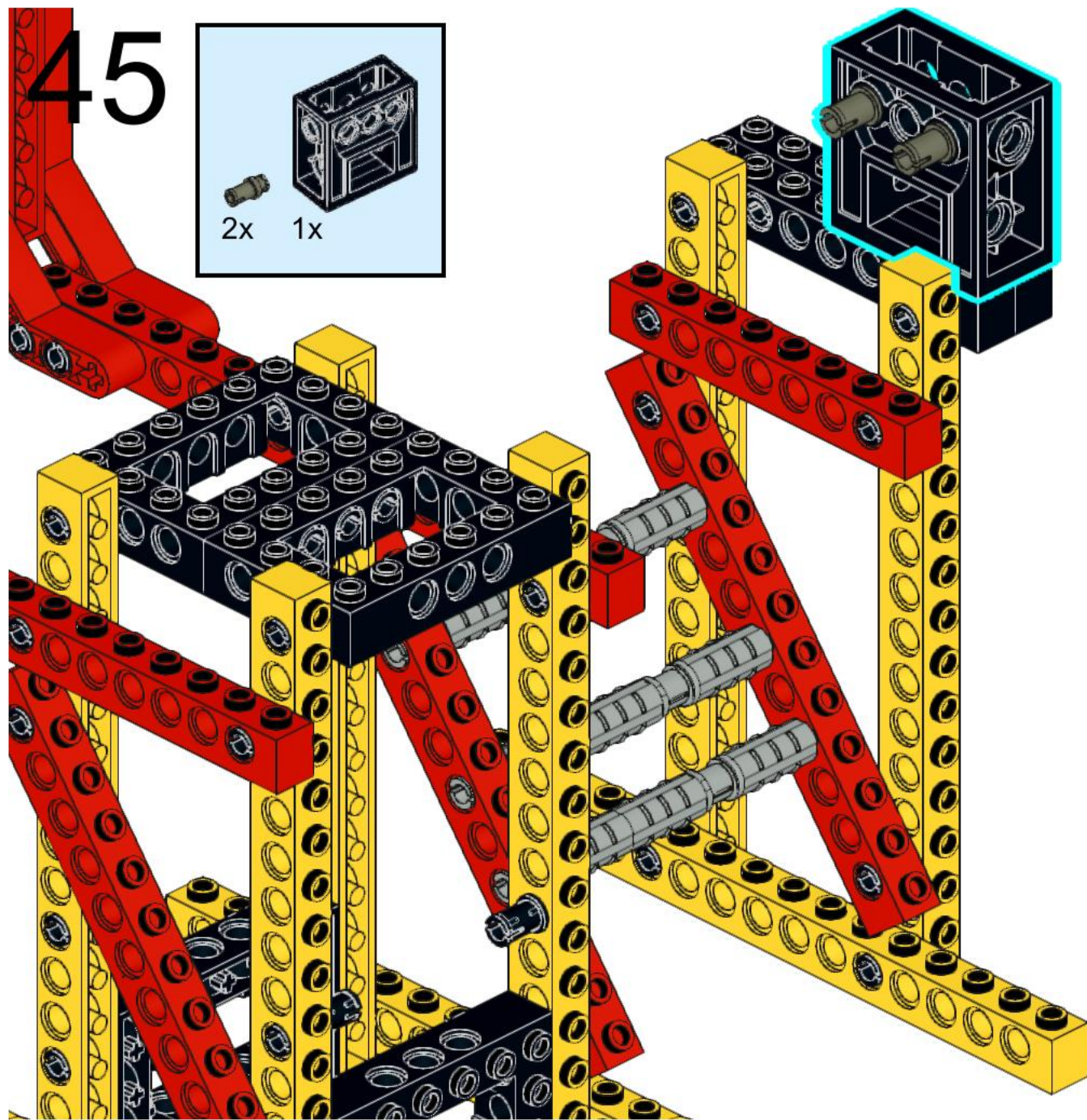
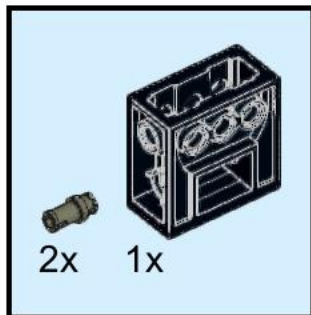

46

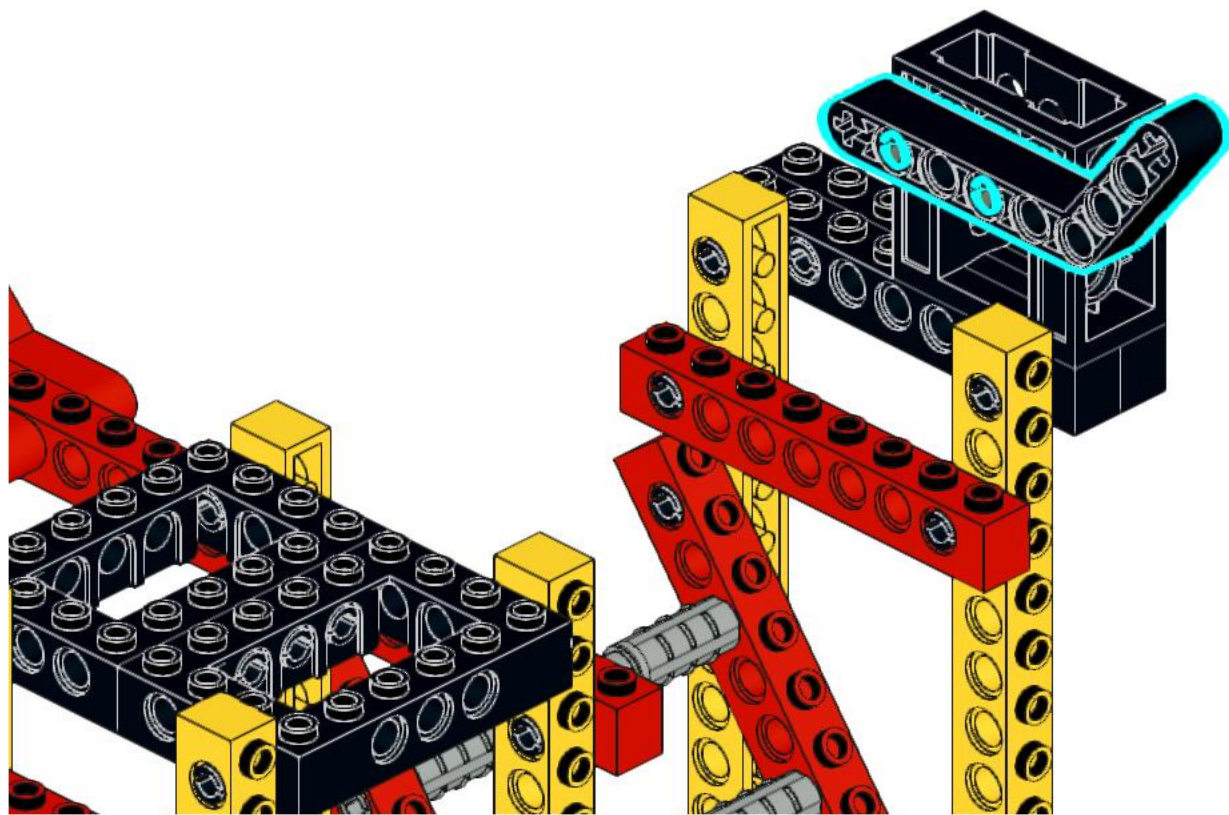
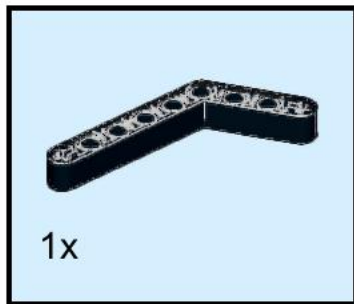

47

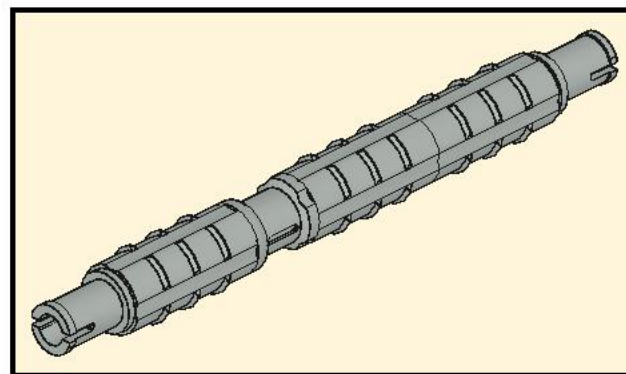
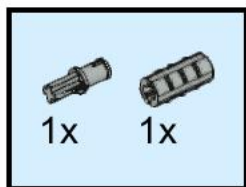

48

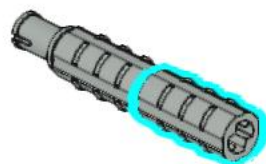
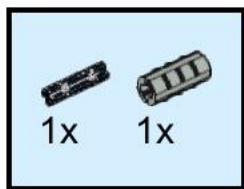

49

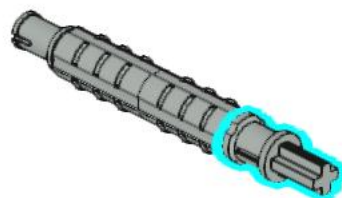
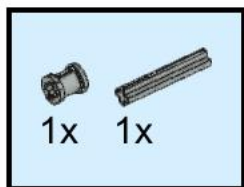

50

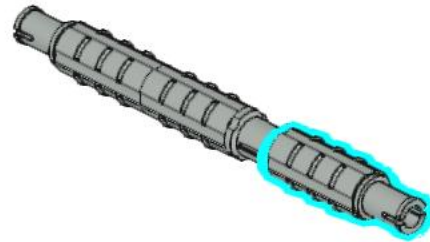
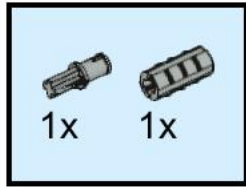

51

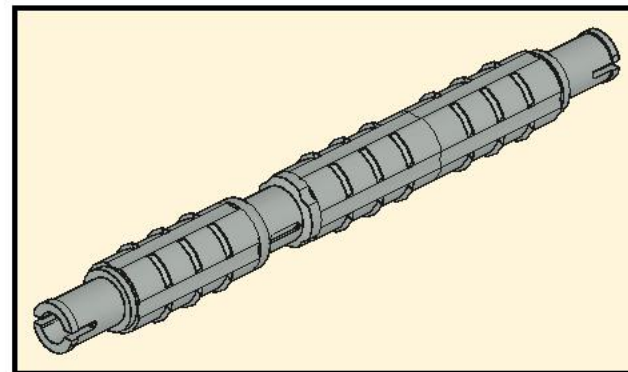
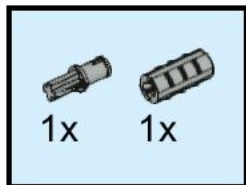

52

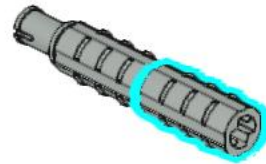
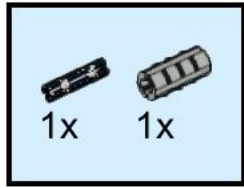

53

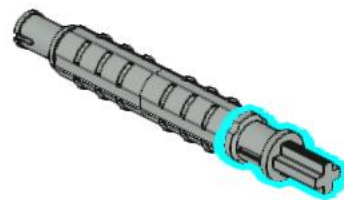
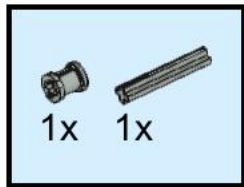

54

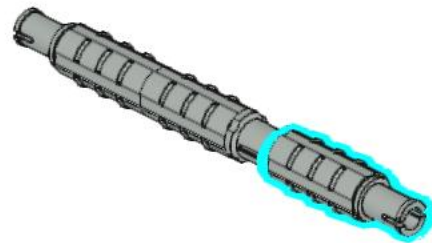
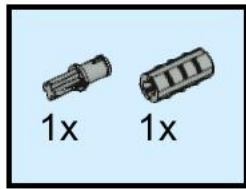

55

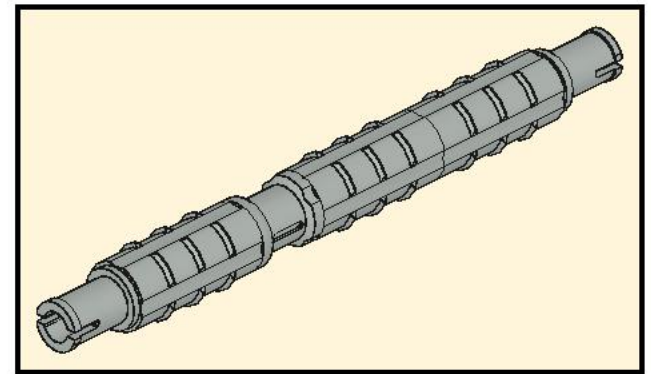
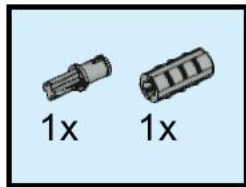

56

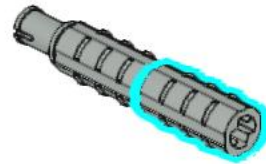
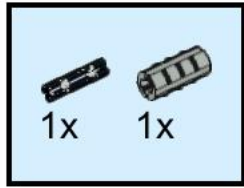

57

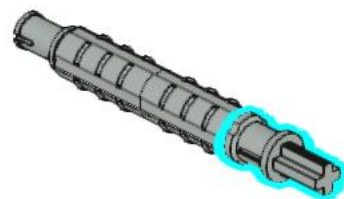
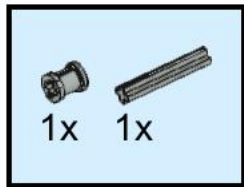

58

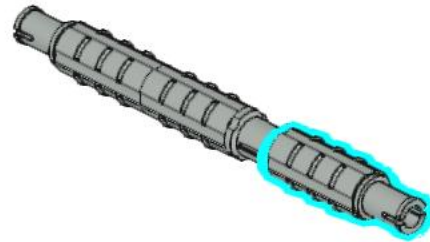
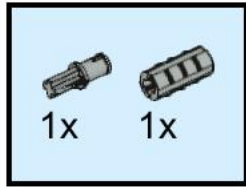

59

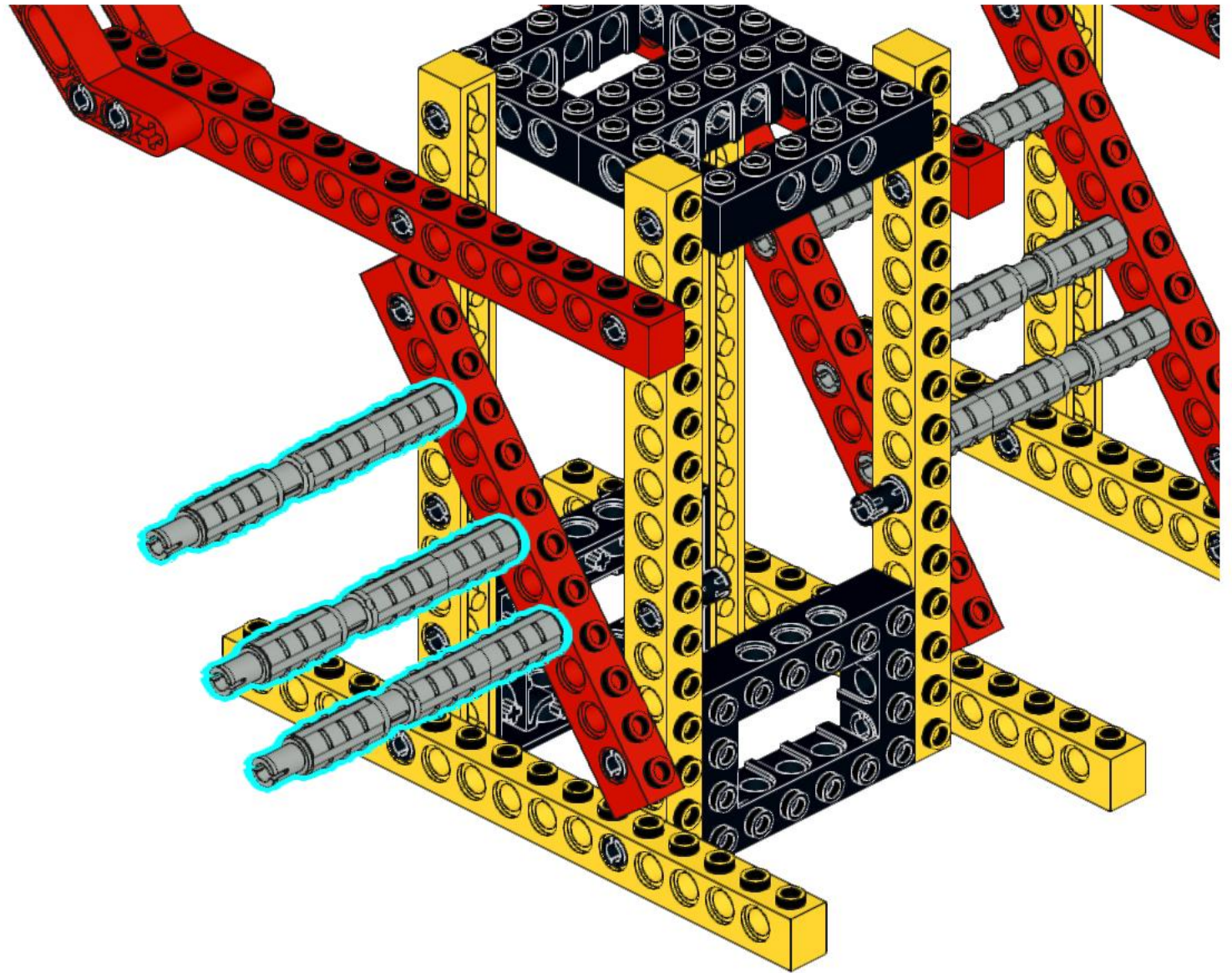

60

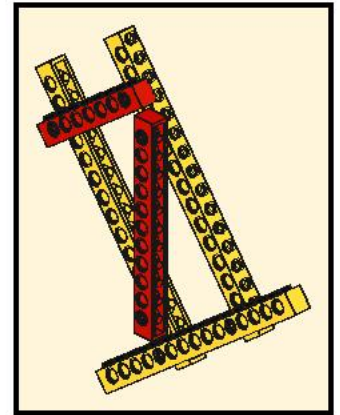
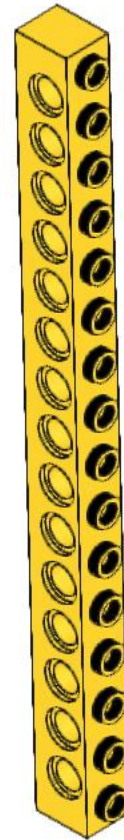
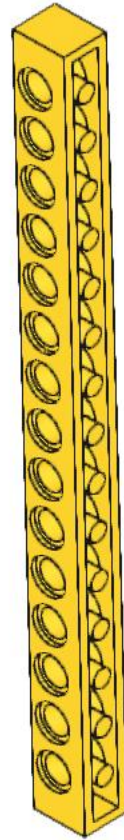
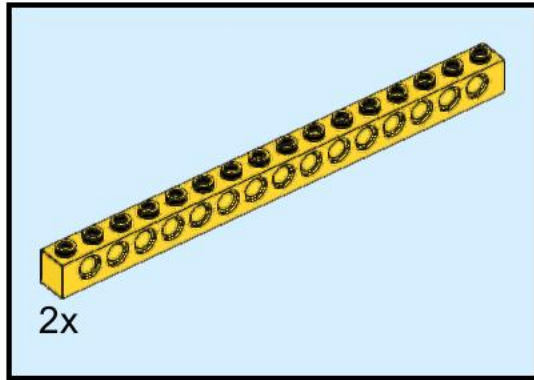

61

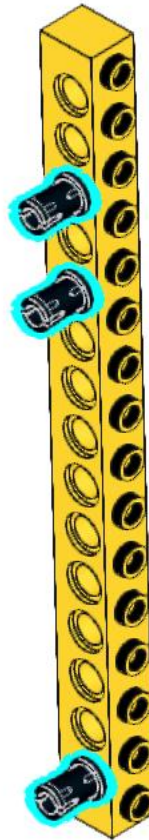
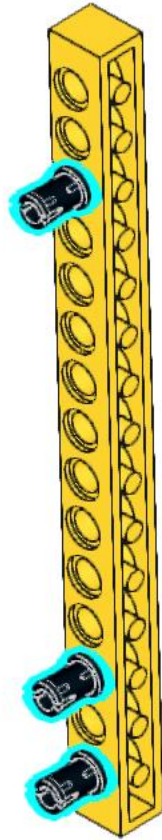

62

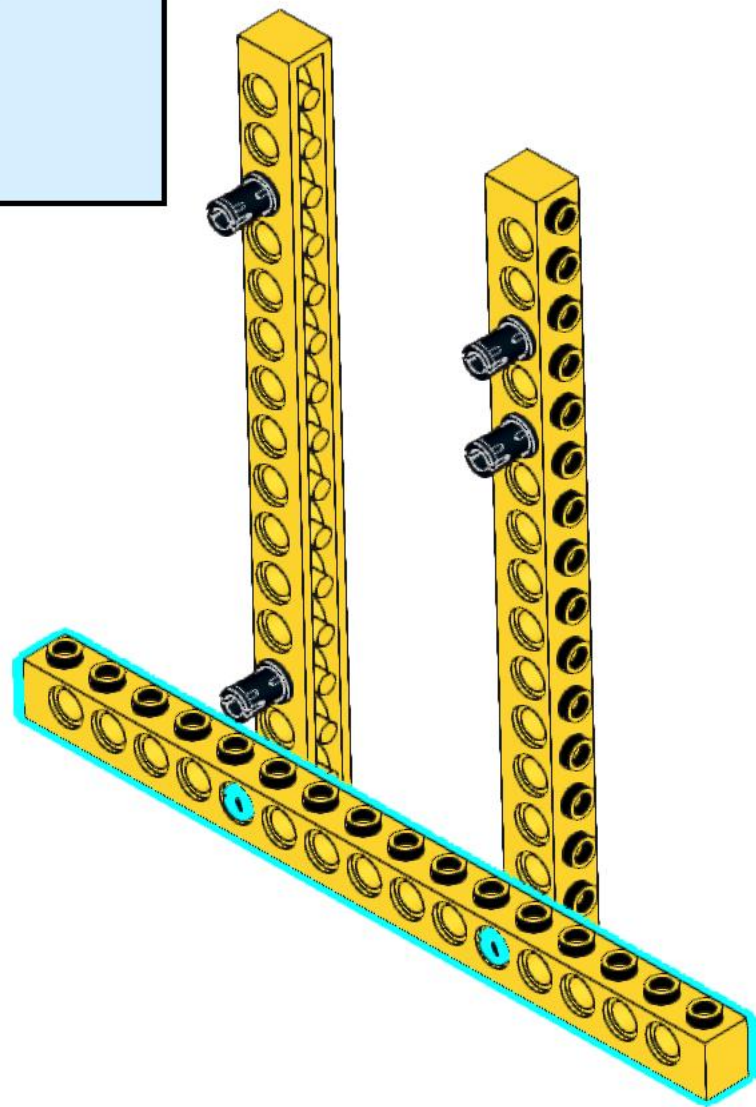
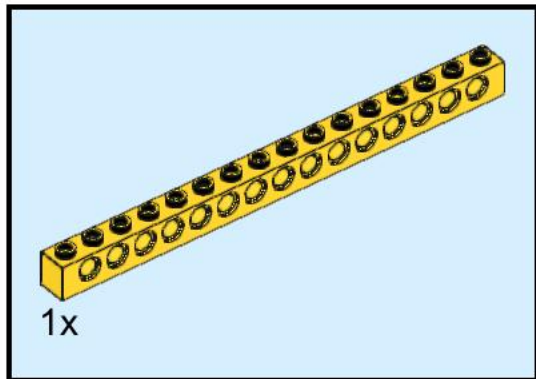

63

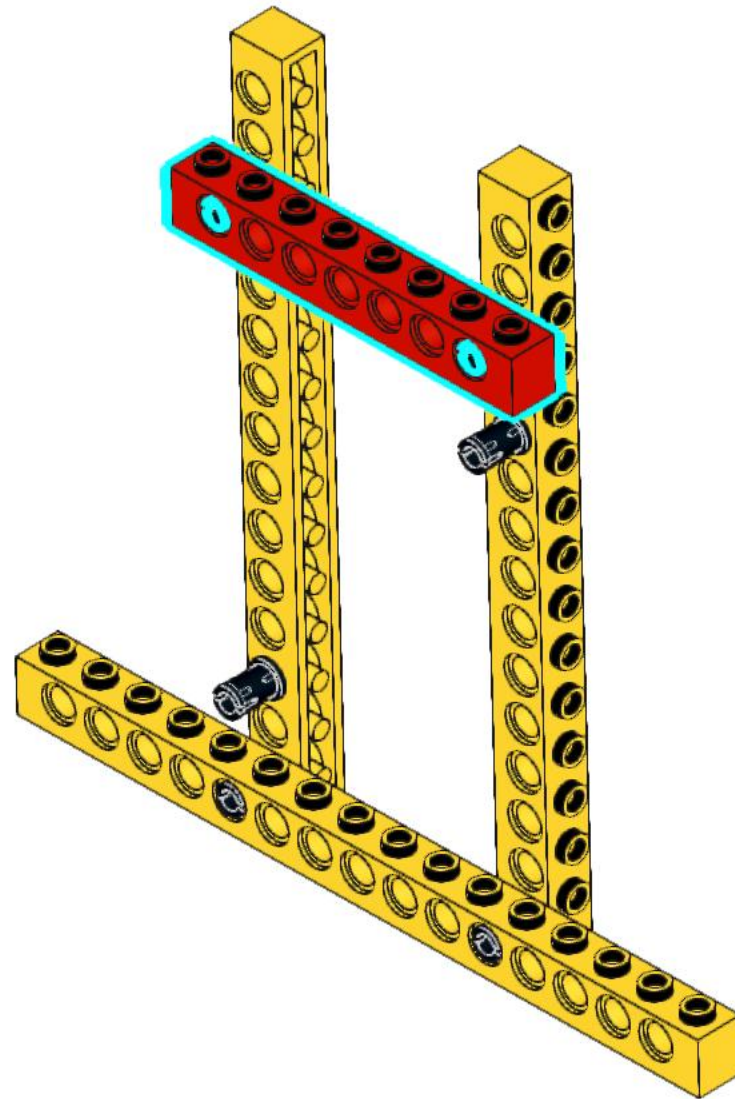
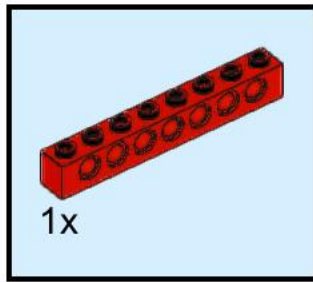

64

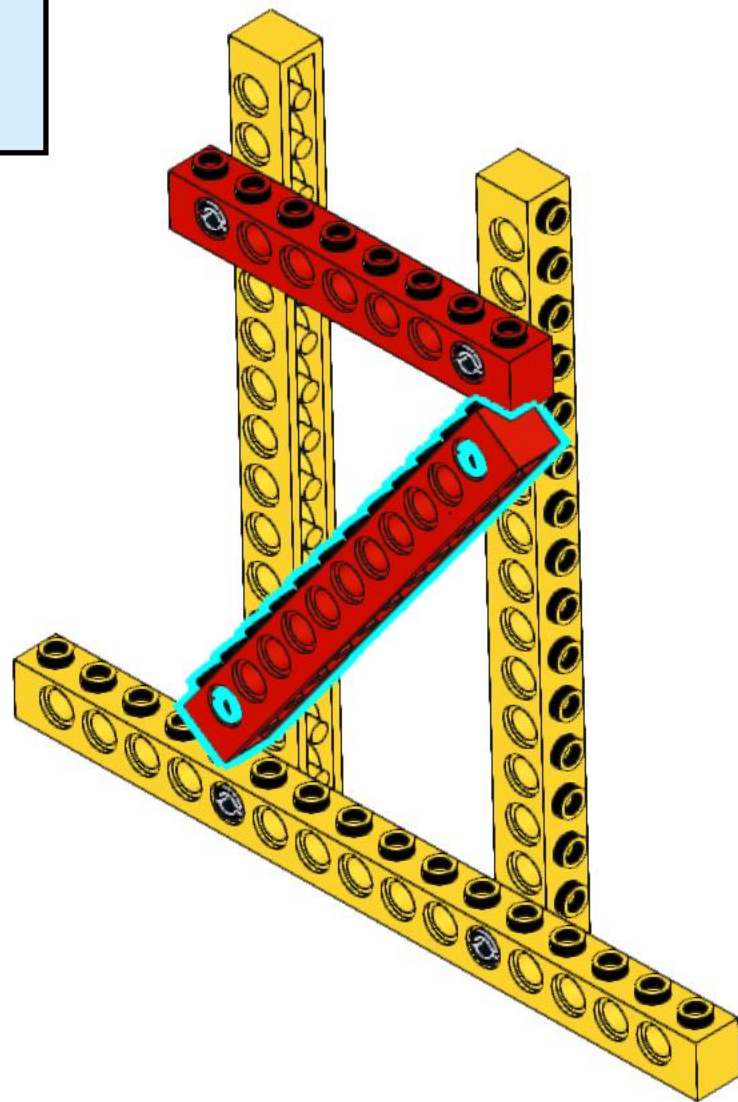
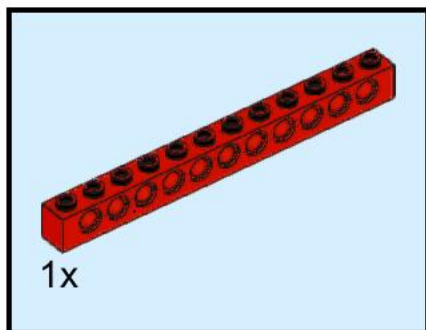

65

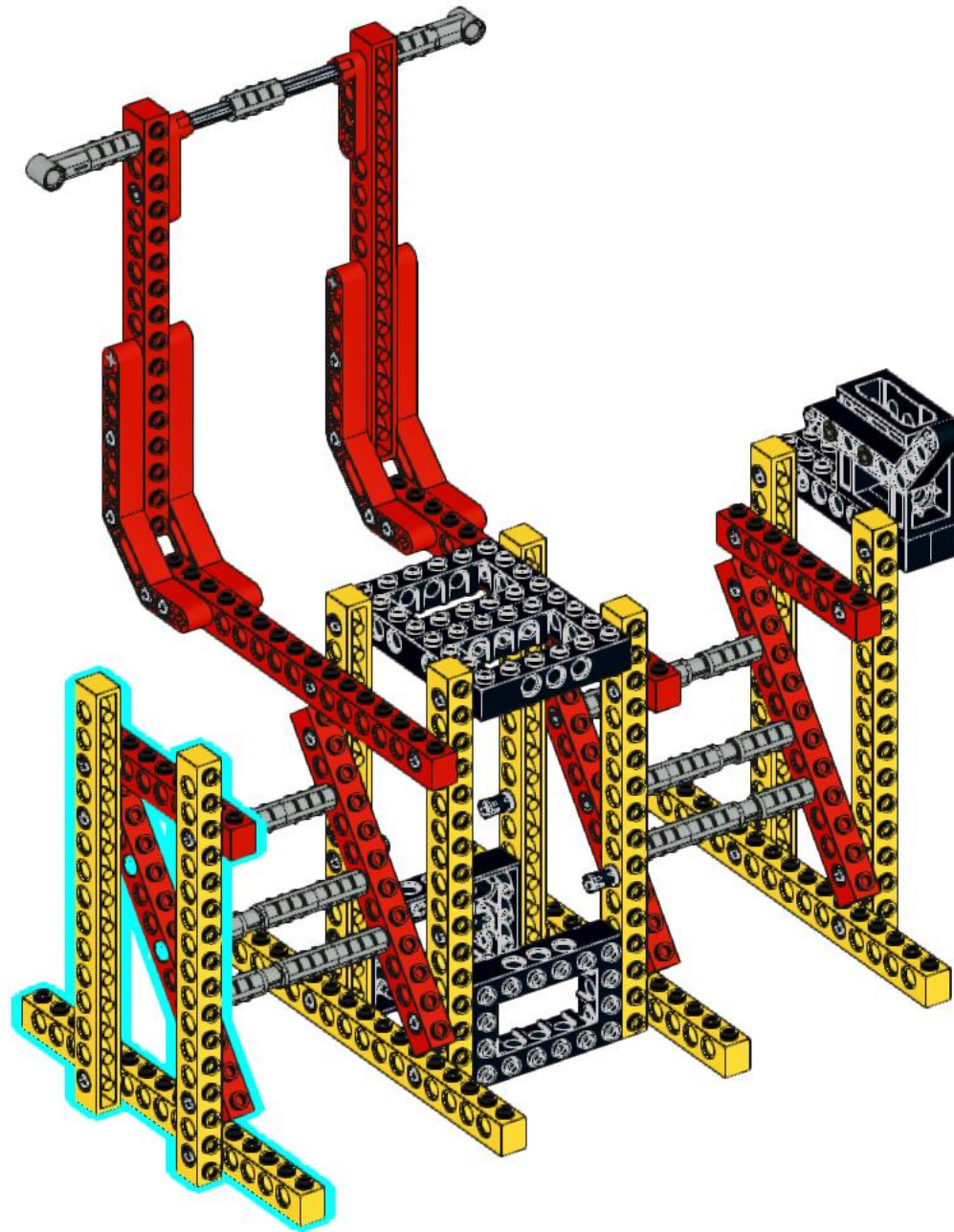

66

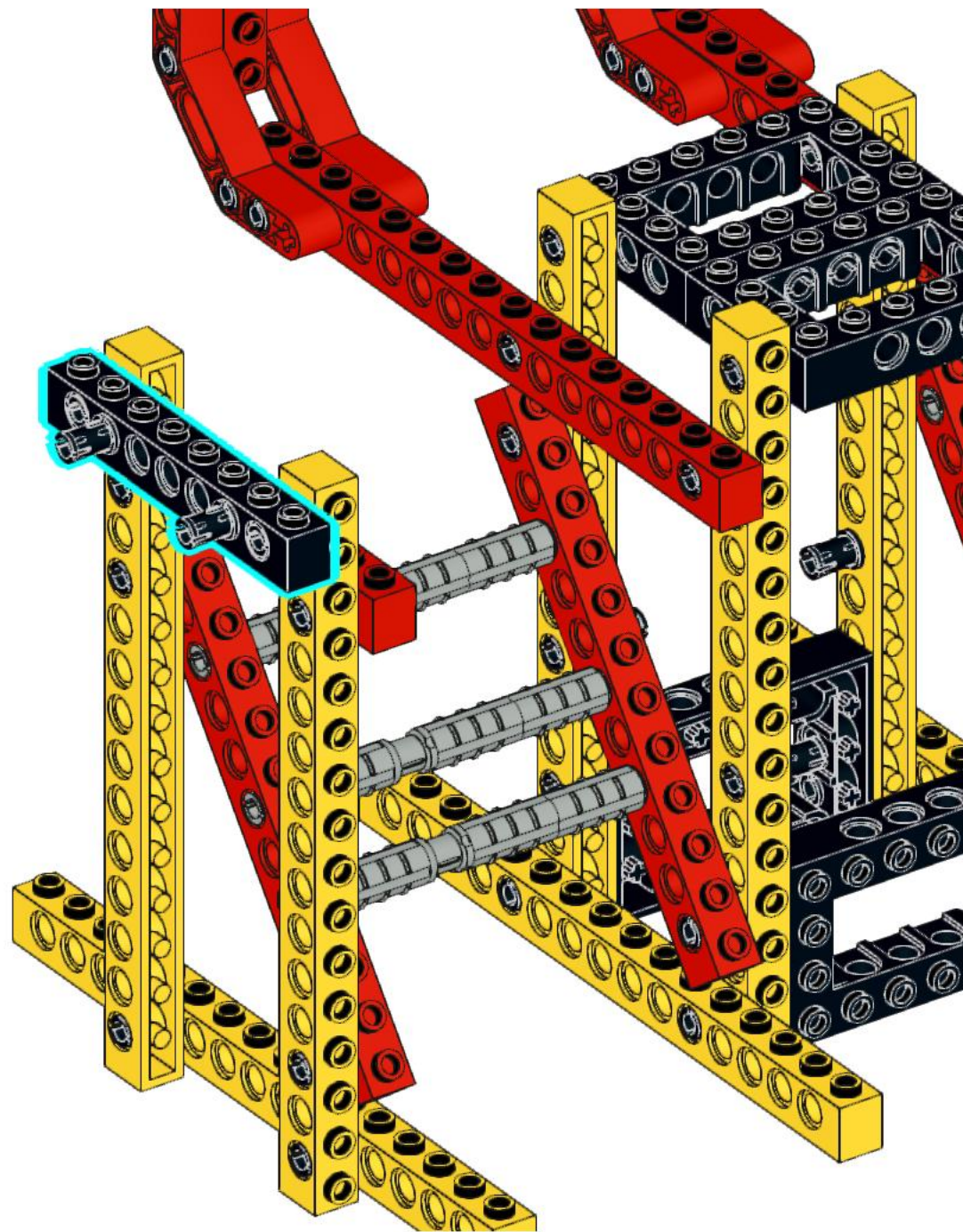
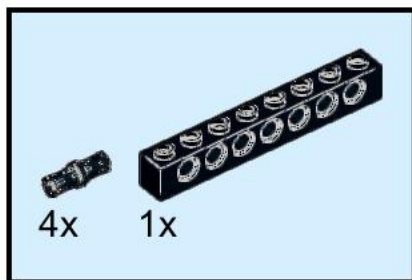

67

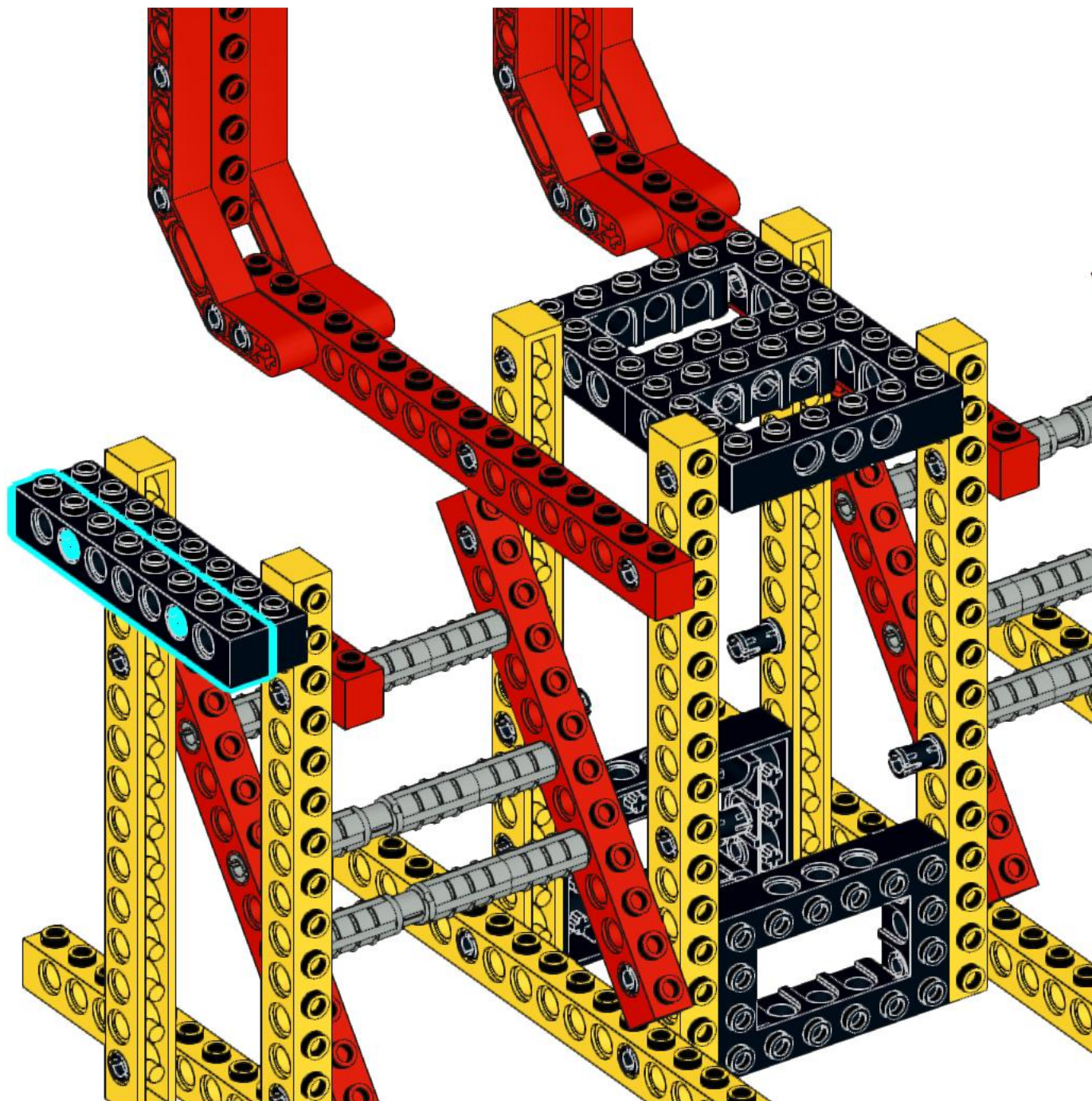
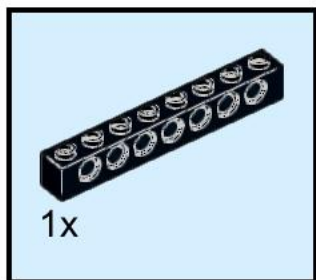

68

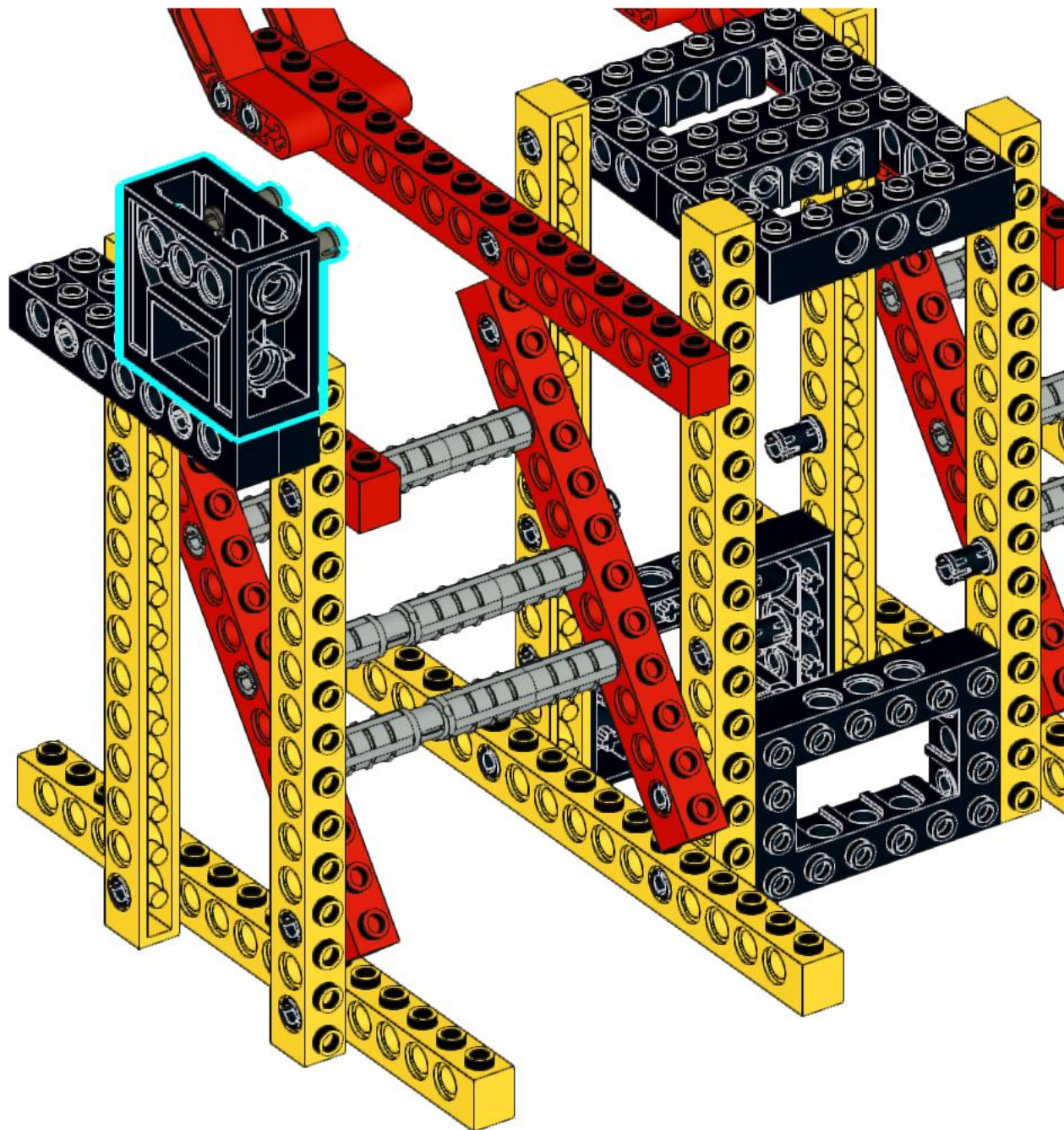
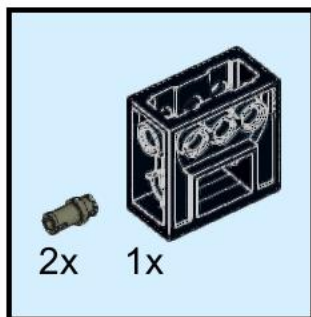

69

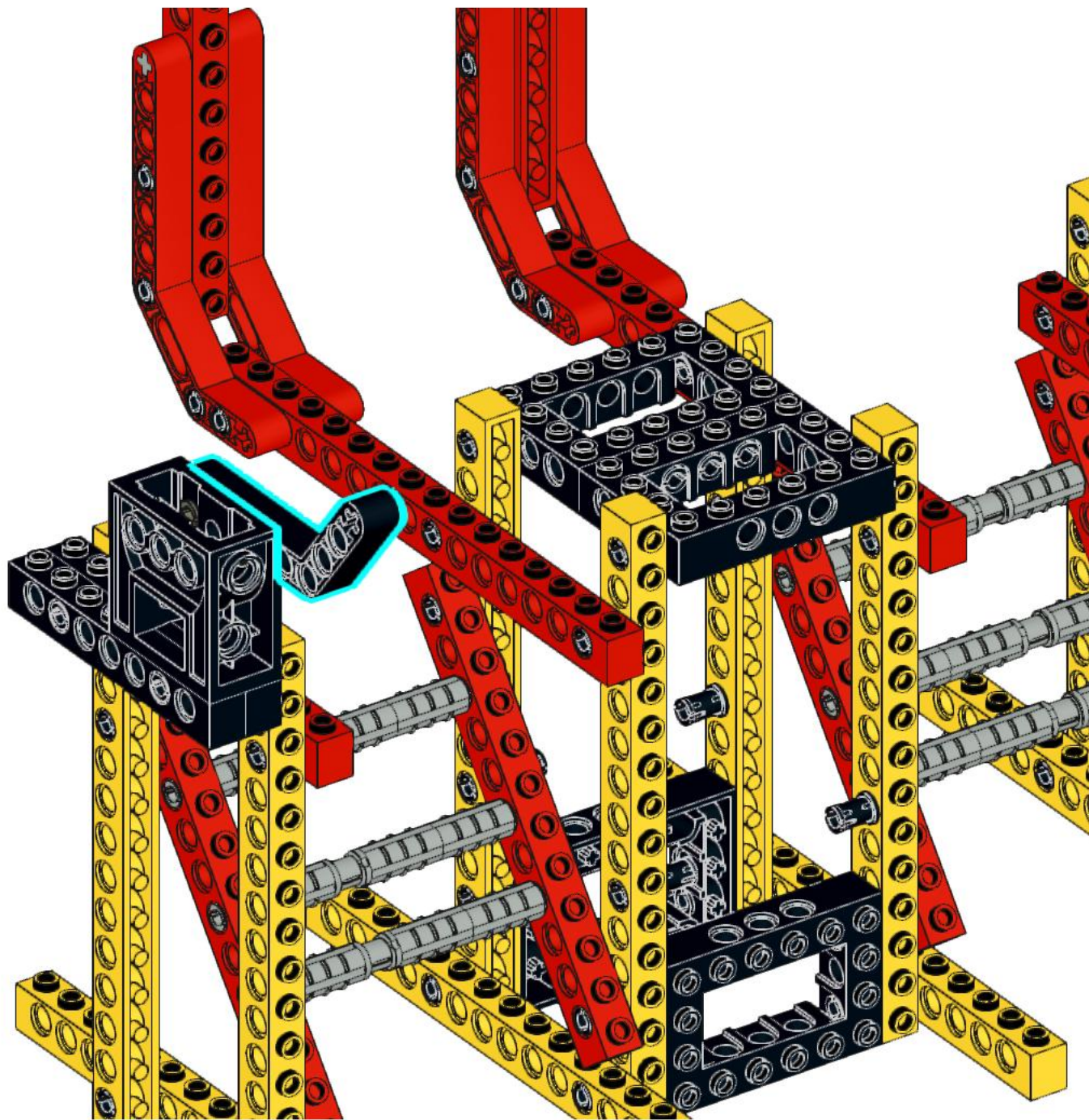
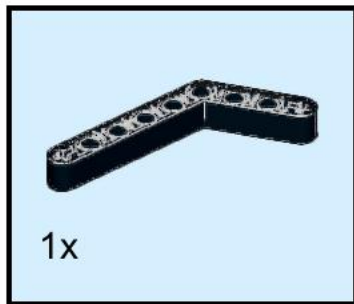

3D Model Interactive eBook

LEGO® Engineering FUNDAMENTALS

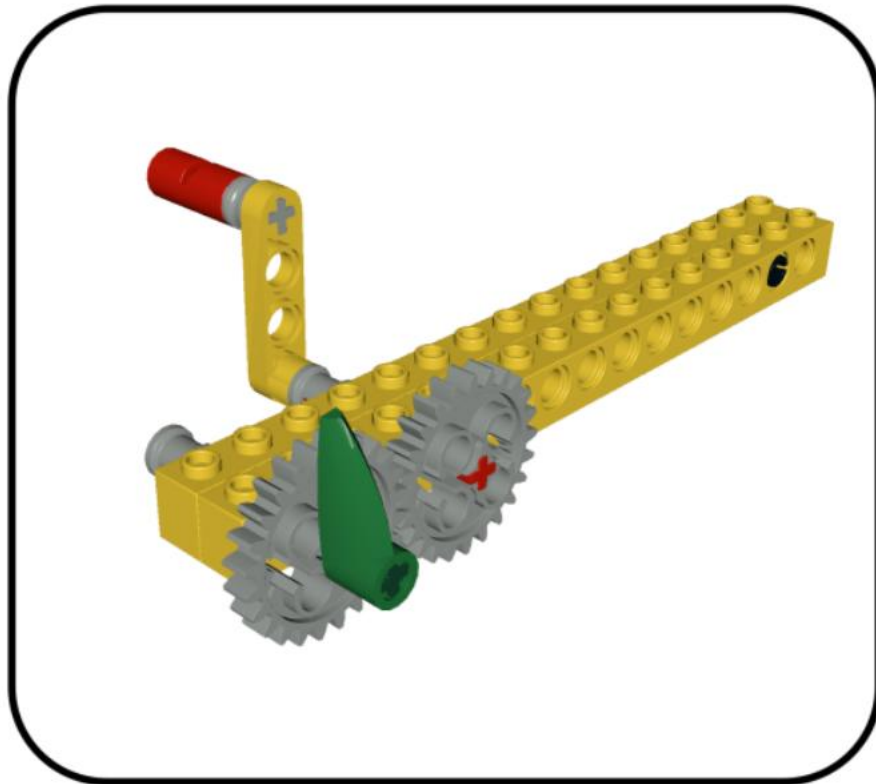

Jorge Moreno Barrios

This is a 3D Model Interactive eBook about LEGO Engineering Fundamentals. The book is divided into five main chapters. Chapter one covers LEGO Bricks alignment and LEGO units. Chapter two is a 3D catalog of LEGO Technic Parts. Chapter three covers the six classic simple machines: Lever, Wheel & Axle, Pulley, Inclined Plane, Wedge, and Screw. Chapter four covers basic mechanisms: Gear, Chain, Cam, Pawl & Ratched, Junctions, and Linkages. Chapter five cover basic structures.

Most of the book contains animated 3D models with technical information that appears when you rotate the model.

The technical information presented is based on notes from the LEGO Education Teacher's Guide, LEGO Basics from Georgia Tech and Alexander Slocum's Fundamentals of Design from MIT.



<https://books.apple.com/us/book/id1527216275>