

SKILL LEVEL



BEGINNER

multisized  
pattern...sizes  
6/8/10/12/14/16  
/18/20/22/24/26  
all together!

*www.hotpatterns.com*<sup>tm</sup>  
patterns so hot they're smokin'...

HotPatterns & fabric.com exclusive download  
Peachy Beachy Pool-Side Cover-Up

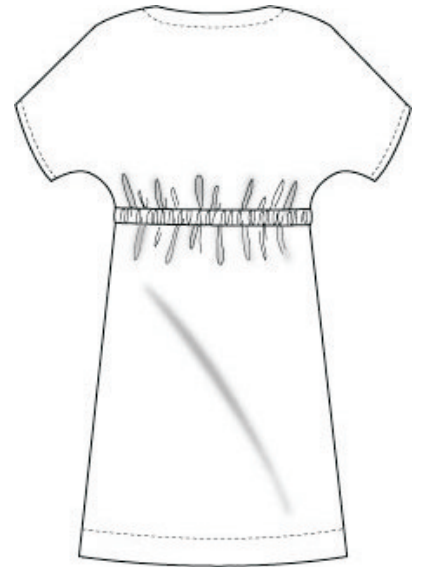
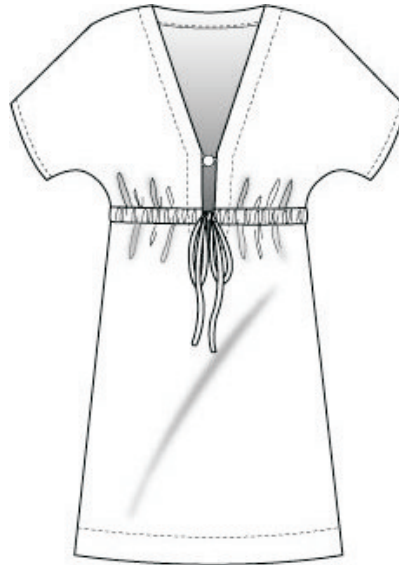

幽居的猪 纸样工作室

<http://shop62054828.taobao.com/>

Summer-time fabulousness and pool-side glamour with this chic and simple cover-up, perfect for drapey or semi-sheer fabrics like cotton lace, handkerchief linen, rayon or voile, but also great in light weight T-shirtings or a snuggly-soft terry toweling. Pull-over, semi-fitted cover-up has a low V-neck with button closure, short dolman sleeves, a drawstring under the bust, and finishes at mid thigh. Wear this vacation essential over your swimsuit or bikini when the sun is just *too much*...lounging poolside, relaxing at the beach or chilling out at the bar.

# Hot Patterns & fabric.com

## exclusive free download peachy beachy pool-side cover-up instructions page 1 of 2

### SEAM ALLOWANCES & OTHER INFO

Seam allowances are 5/8" or 1.5 cm wide; all seams are sewn right sides together unless otherwise stated.

The neckline has a stitched-down facing; the sleeve edges have a 5/8" or 1.5cm deep hem and the bottom edge has a 1 1/2" or 3.5 cm deep stitched hem.

Skills needed include: making & applying a neck facing; making & applying an elastic waist casing; making & applying a button & loop; working a hem..

### ABOUT THIS STYLE

The Cover-up has an semi-fitted, slightly relaxed silhouette, with an under bust drawstring for snaping.

We haven't included a pattern for the button loop... you just need to cut a 3" or 7.5 cm long bias strip of 1 1/2" or 3.75 cm wide fabric.

Oh yes, as always, make & fit a muslin before you cut into your fabric. In this case, use a cheap fabric with a similar drape to your chosen fabric.

### SUGGESTED CUTTING LAYOUT FOR THE LOWER FRONT & BACK COVER-UP

fold fabric in half, with selvages to the middle for this layout

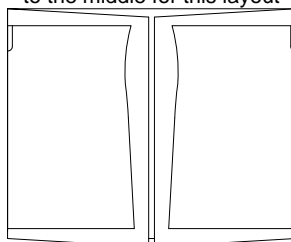

### SUGGESTED CUTTING LAYOUT FOR THE REMAINING COVER-UP PIECES

fold fabric in half, with selvage to selvage for this layout

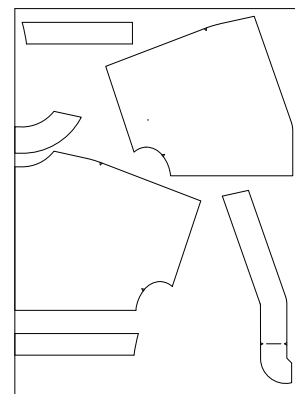

### FABRIC & NOTIONS REQUIRED

You'll need around 2 1/4 yards/ 205 cm of 60"/150cm wide fabric for the cover-up.

You'll also need enough 1" or 2.5 cm wide ribbon to circle under your bust twice, plus 1 x 3/4" or 2cm button.

### 1 Start by preparing the bias for the button loop.

Feed your bias strip through a bias binding folder, pressing as you go. fold in half lengthways, then topstitch the long ends together.

Set aside until step 6.

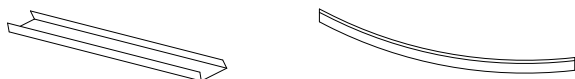

### 2 Join the front waist casings to the back waist casing along the side seams, and press the seams open.

Press and stitch the short ends under 5/8" or 1.5cm.

Set aside until step 5a.

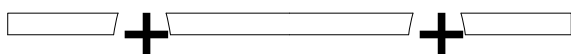

Join the front facings together at the center front seam, then join the front facing to the back facing along the shoulder seams, and press the seams open.

### 3

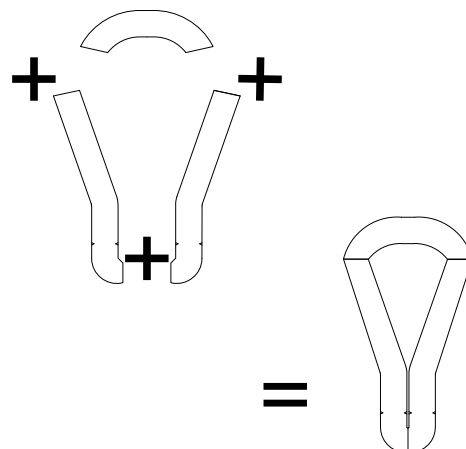

# instructions page 2 of 2

**4a** Join the lower front to the lower back along the side seams, and press the seams open.

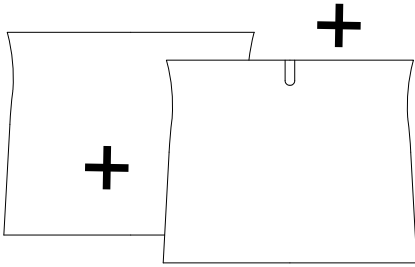

Join the upper fronts to the upper back along the shoulder and side seams, and press the seams open.

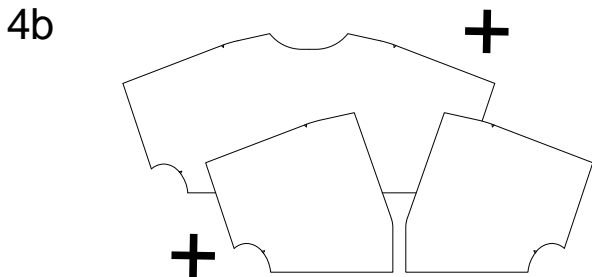

幽居的猪 纸样工作室

Following the stitchline marked on the pattern, stitch the bottom edge of the casing to the lower front & back. Press this casing upwards... the raw edge of the casing should align with the raw edge of the lower back & front.

**5a** Baste or pin the upper edges of the casing and the lower front & back together.

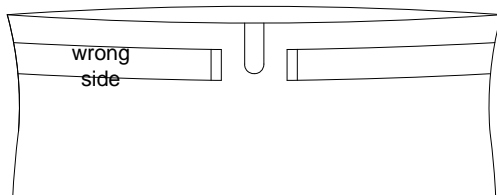
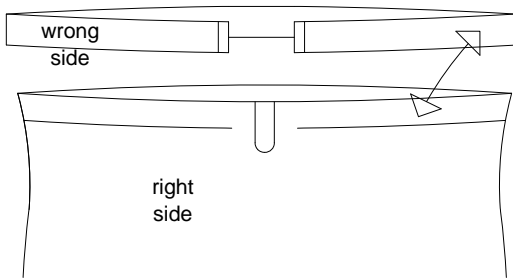

Matching the side seams and the center fronts & backs, join the upper fronts & back to the lower front & back...you'll sandwich the casing edge in as you go. Press the seam allowances downwards.

**5b**

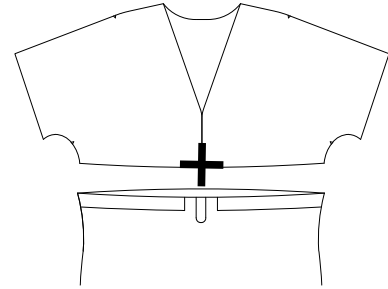

Baste or pin the bias button loop into place (you'll see the correct position on the pattern)...you'll seal this in when you attach the facing.

**6**

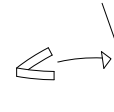

**7**

Matching the shoulder seams and the center fronts & backs, join the neckline facing to the cover-up.

When you reach the lower front area, you'll follow the stitchline as marked on the pattern.

Clip the seam allowances, press the seams open and turn the facing inside the cover-up. Topstitch the facing down, starting and finishing at the center back.

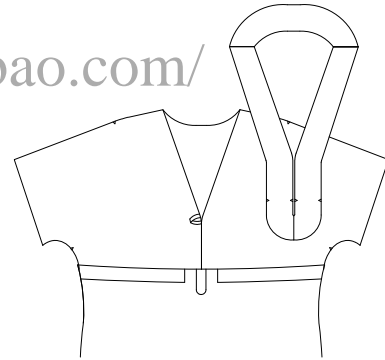

**8**

Hem the sleeves with a 5/8" or 1.5cm turning; hem the bottom with a 1 1/2" or 3.75cm turning.

Complete the cover-up by attaching a button to correspond with the button loop, and threading your drawstring through the casing... do this by pinning a safety pin through the drawstring and threading it in one opening, along the casing and out the other opening.

Voila! Total summer-time gorgeousness!

幽居的猪 纸样工作室

<http://shop62054828.taobao.com/>

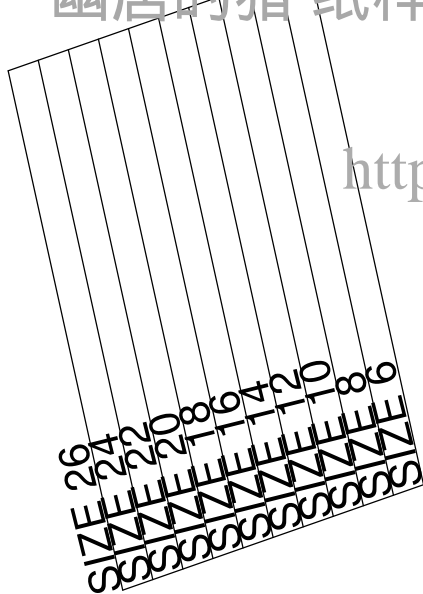

SIZE 26  
SIZE 24  
SIZE 22  
SIZE 20  
SIZE 18  
SIZE 16  
SIZE 14  
SIZE 12  
SIZE 10  
SIZE 8  
SIZE 6

SIZE 26  
SIZE 24  
SIZE 22  
SIZE 20  
SIZE 18  
SIZE 16  
SIZE 14  
SIZE 12  
SIZE 10  
SIZE 8  
SIZE 6

*Hot Patterns & fa*

exclusive free dow

peachy beachy pool-si

upper back

cut 1 on fold in f

幽居的猪 纸样工作室

<http://shop62054828.taobao.com/>

FOLD

幽居的猪 纸样工作室

<http://shop62054828.taobao.com/>

SIZE 26  
SIZE 24  
SIZE 22  
SIZE 20  
SIZE 18  
SIZE 16  
SIZE 14  
SIZE 12  
SIZE 10  
SIZE 8  
SIZE 6

幽居的猪 纸样工作室

<http://shop62054828.taobao.com/>

SIZE 26  
SIZE 24  
SIZE 22  
SIZE 20



幽居的猪 纸样工作室

<http://shop62054828.taobao.com/>



SIZE 26  
SIZE 24  
SIZE 22  
SIZE 20  
SIZE 18  
SIZE 16  
SIZE 14  
SIZE 12  
SIZE 10  
SIZE 8  
SIZE 6

<http://shop62054828.taobao.com/>

FOLD

*Hot Patterns* & fabric.com

exclusive free download  
peachy beachy pool-side cover-up  
back drawstring casing  
cut 1 on fold in fabric

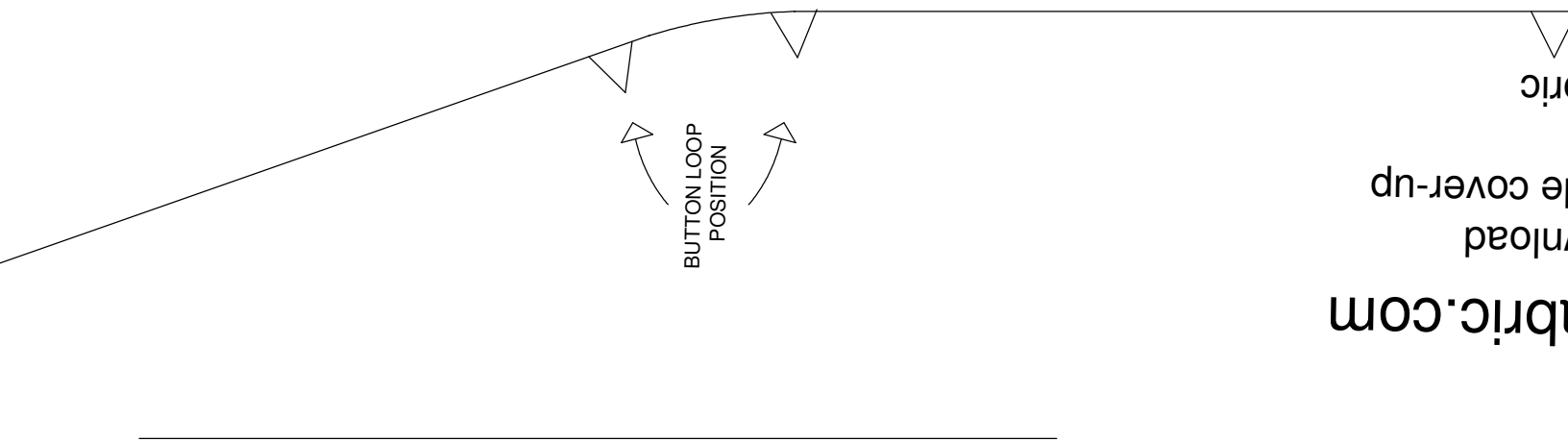

abric.com  
load  
cover-up  
ric

幽居的猪 纸样工作室

<http://shop62054828.taobao.com/>

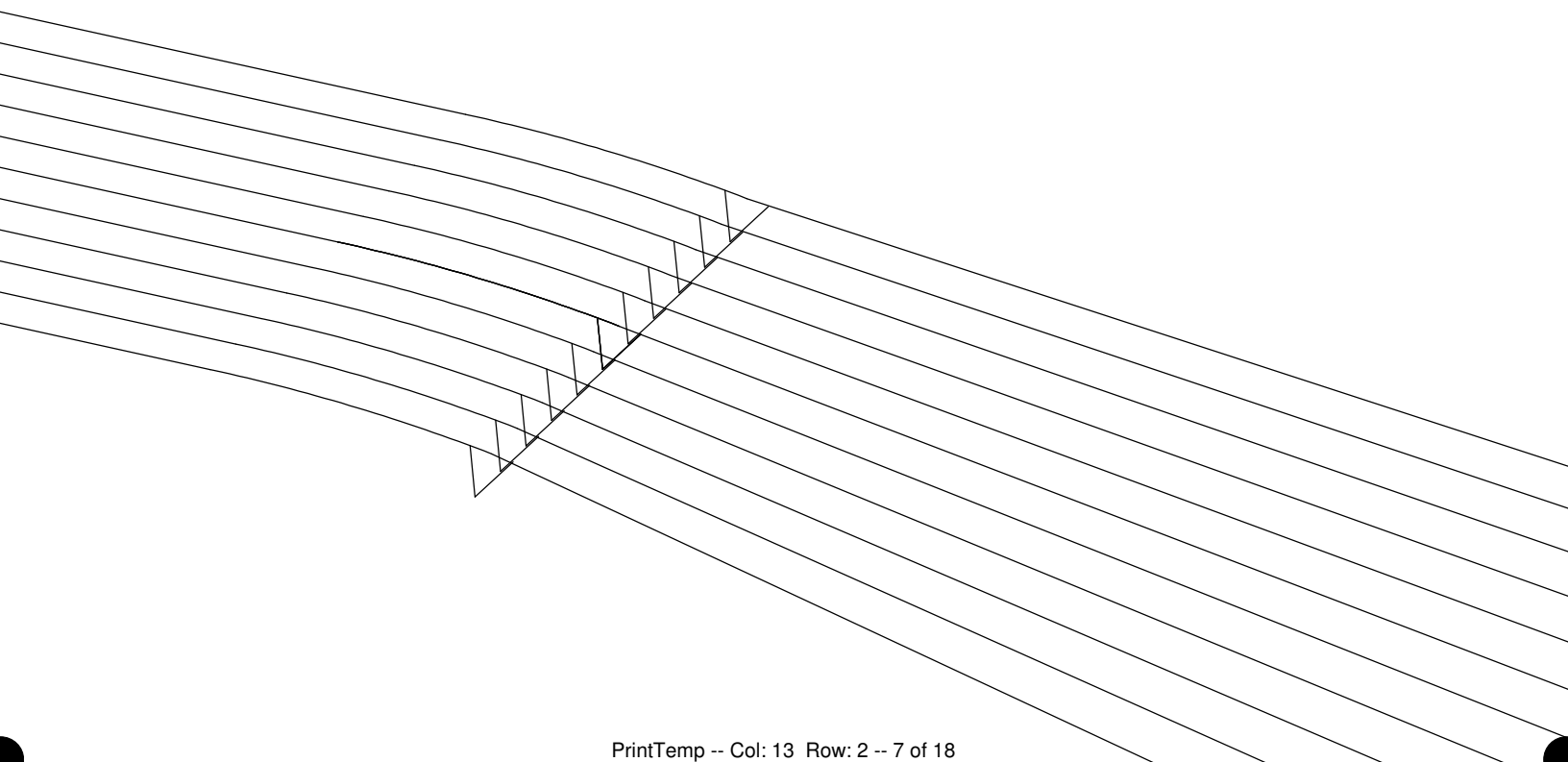

abric.com

ownload

de cover-up

幽居的猪 纸样工作室

abric

<http://shop62054828.taobao.com/>

SIZE 6  
SIZE 8  
SIZE 10  
SIZE 12  
SIZE 14  
SIZE 16  
SIZE 18  
SIZE 20  
SIZE 22

SIZE 26  
SIZE 24  
SIZE 22  
SIZE 20  
SIZE 18  
SIZE 16  
SIZE 14  
SIZE 12  
SIZE 10  
SIZE 8  
SIZE 6

幽居的猪 纸样工作室

<http://shop62054828.taobao.com/>

exclusive free download  
peachy beachy pool-side  
upper front  
cut 1 pair in fabric

幽居的猪 纸样工作室

<http://shop62054828.taobao.com/>

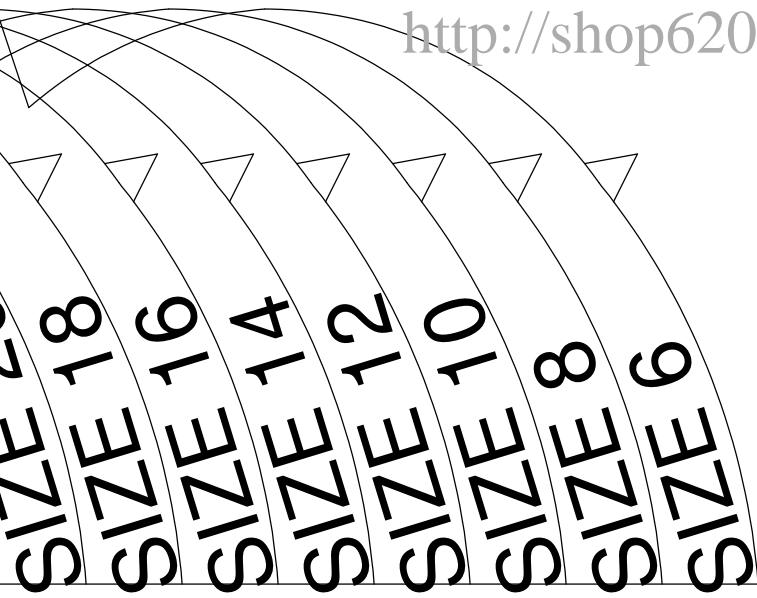

SIZE 26  
SIZE 24

SIZE 22  
SIZE 20  
SIZE 18  
SIZE 16  
SIZE 14  
SIZE 12  
SIZE 10  
SIZE 8  
SIZE 6

*Hot Patterns* & fabric

幽居的猪 纸样工作室

<http://shop62054828.taobao.com/>

exclusive free download  
peachy beachy pool-side cover  
lower front & back  
cut 1 pair on fold in fabric

FOLD

dn-je  
woc.com

Hot Patterns & fabric.com

幽屋的猪纸样工作室

exclusive free download

eachy beachy pool-side cover-up

front drawstring casing

cut 1 pair in fabric

<http://shop62054828.taobao.com/>

SIZE 6  
SIZE 8  
SIZE 10  
SIZE 12  
SIZE 14  
SIZE 16  
SIZE 18  
SIZE 20  
SIZE 22  
SIZE 24  
SIZE 26

SIZE 26  
SIZE 24  
SIZE 22  
SIZE 20  
SIZE 18  
SIZE 16  
SIZE 14  
SIZE 12  
SIZE 10  
SIZE 8  
SIZE 6

FOLD

SIZE 26  
SIZE 24  
SIZE 22  
SIZE 20  
SIZE 18  
SIZE 16  
SIZE 14  
SIZE 12  
SIZE 10  
SIZE 8  
SIZE 6

cut 1 pair in fabric  
 front facing  
 peachy beachy pool-side  
 exclusive free download  
 & fabric.com

幽居的猪 纸样工作室

<http://shop62054828.taobao.com>

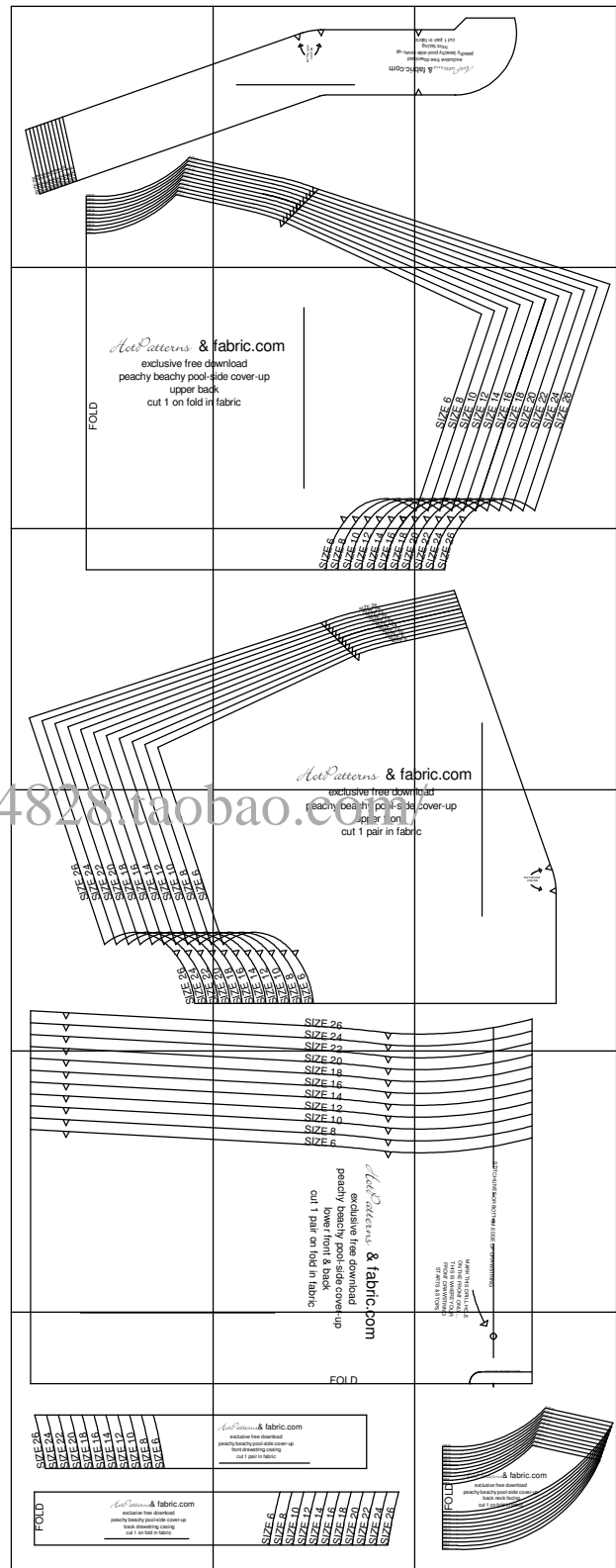



幽居的猪 纸样工作室

SIZE 6

SIZE 8

SIZE 10

SIZE 12

SIZE 14

SIZE 16

SIZE 18

SIZE 20

SIZE 22

SIZE 24

SIZE 26

<http://shop62054828.taobao.com/>

SIZE 22  
SIZE 24  
SIZE 26

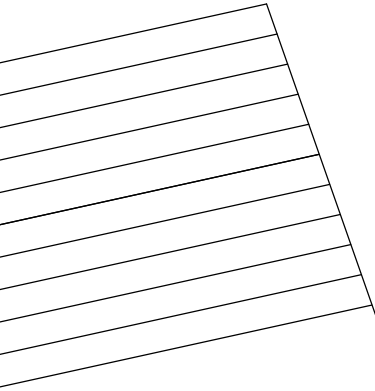

幽居的猪 纸样工作室

<http://shop62054828.taobao.com/>

oad  
cover-up



BUTTON LOOP  
POSITION

幽居的猪 纸样工作室

<http://shop62054828.taobao.com/>



幽居的猪 纸样工作室

<http://shop62054828.taobao.com/>

STITCHLINE FOR BOTTOM EDGE OF DRAWSTRING

MARK THIS DRILL  
ON THE FRONT OF  
THIS IS WHERE Y  
FRONT DRAWSTRI  
STARTS & STO

PS  
RING  
OUR  
ONLY...  
HOLE

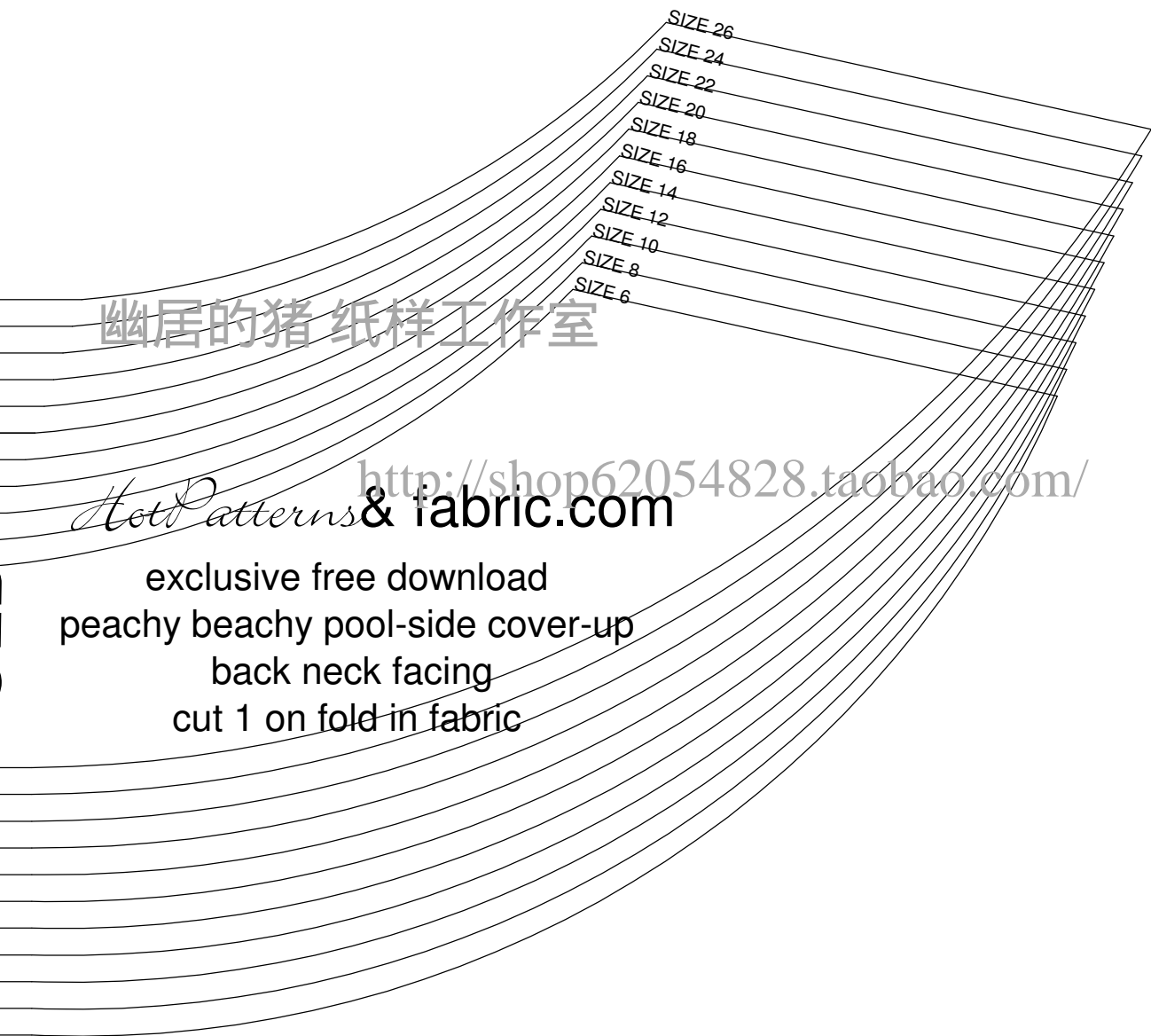
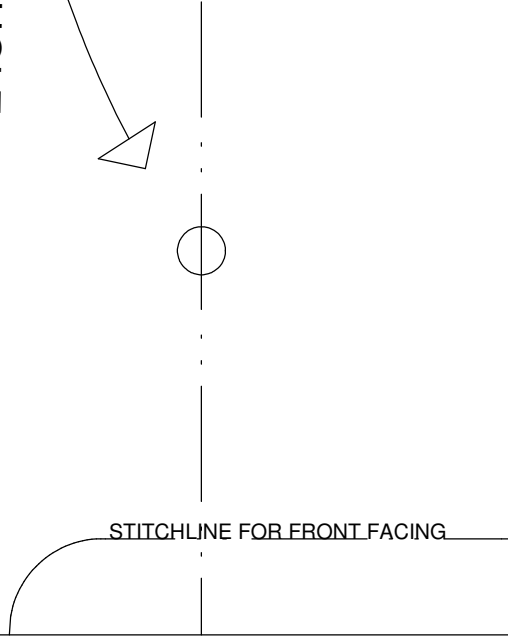

幽居的猪 纸样工作室

*Hot Patterns* & fabric.com <http://shop62054828.taobao.com/>

exclusive free download  
peachy beachy pool-side cover-up  
back neck facing  
cut 1 on fold in fabric