

head fish

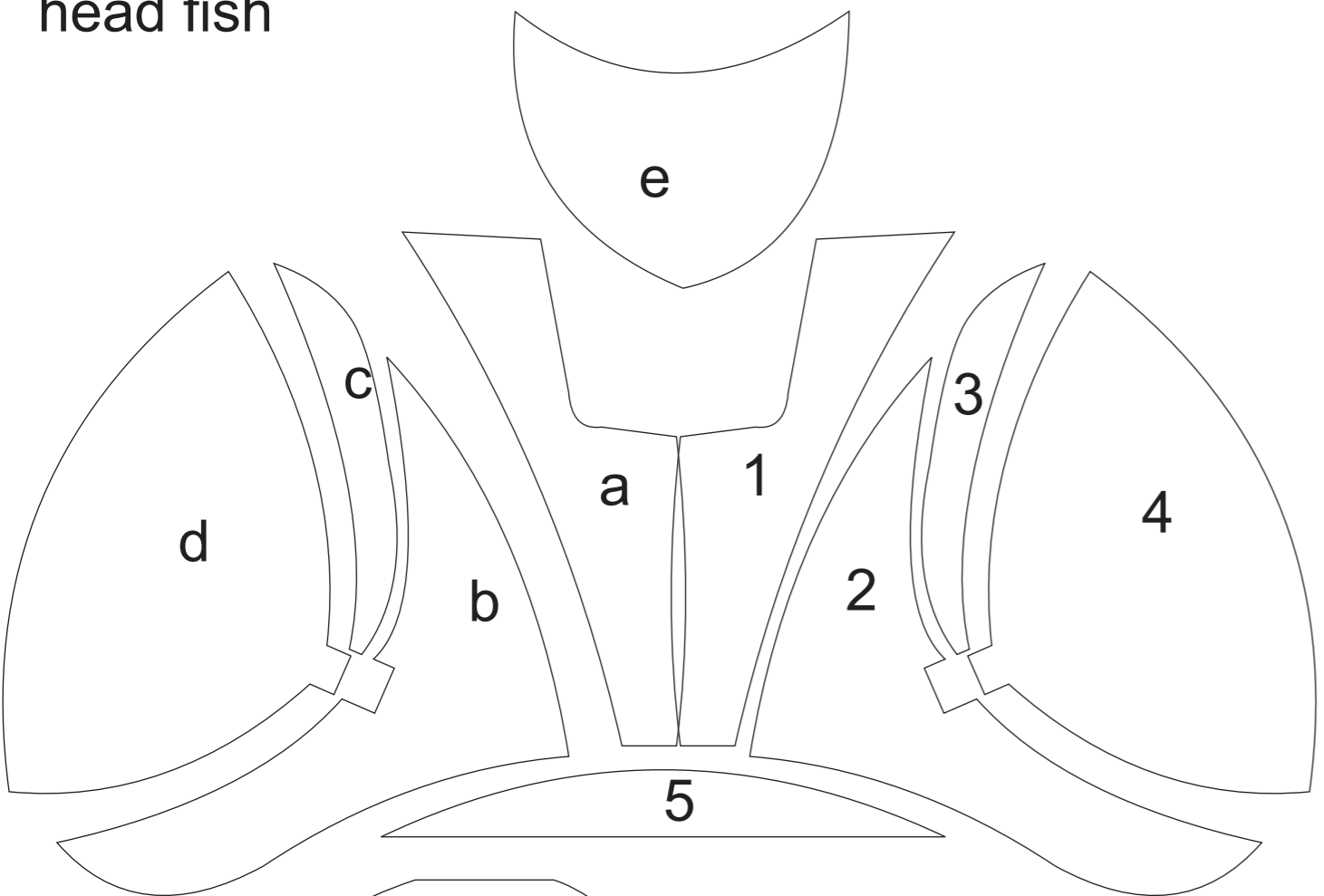

measuring

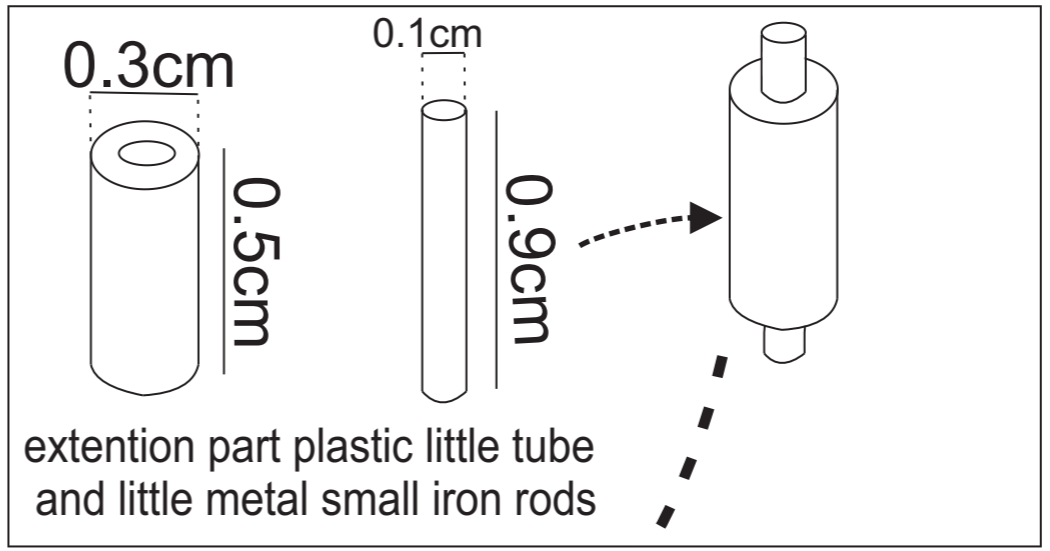
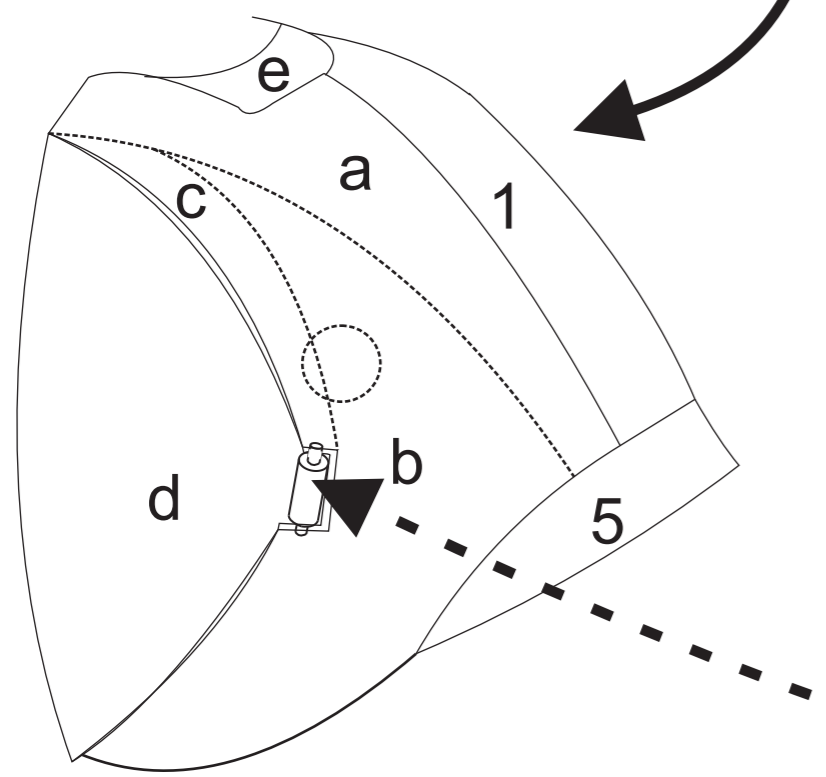
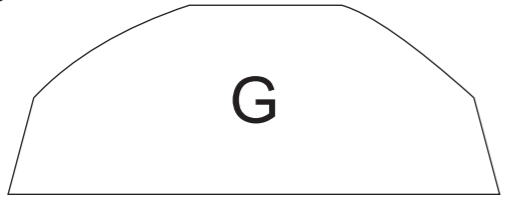
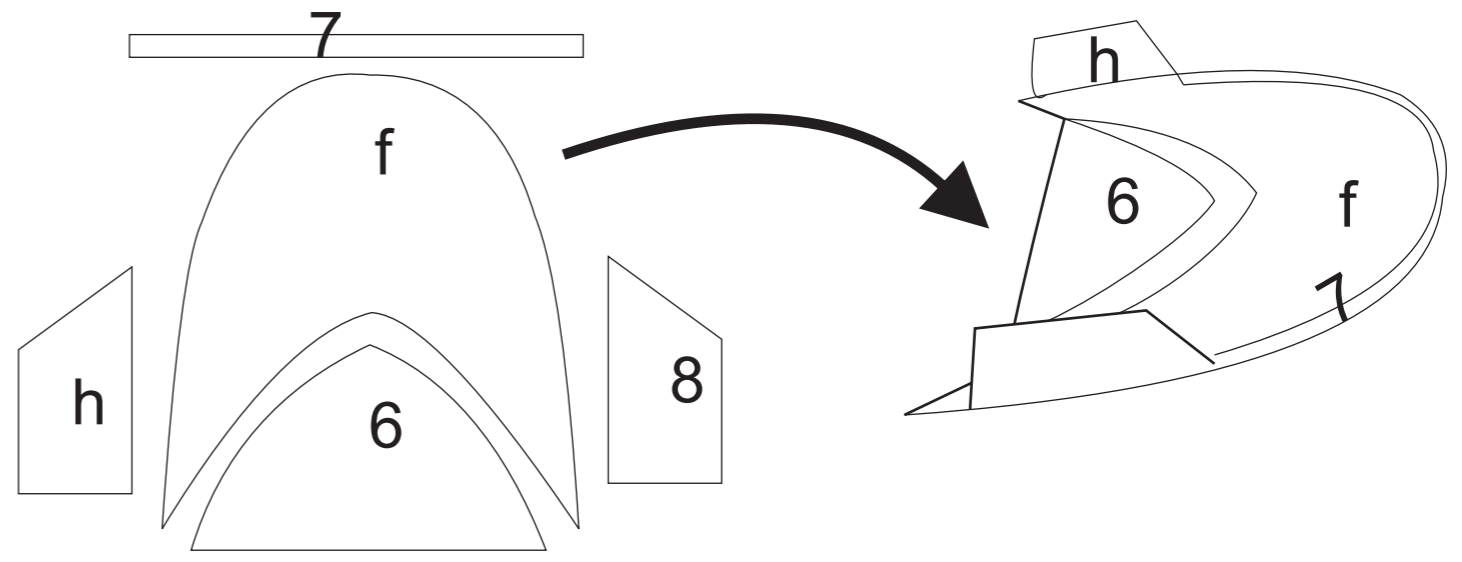

cut on the line

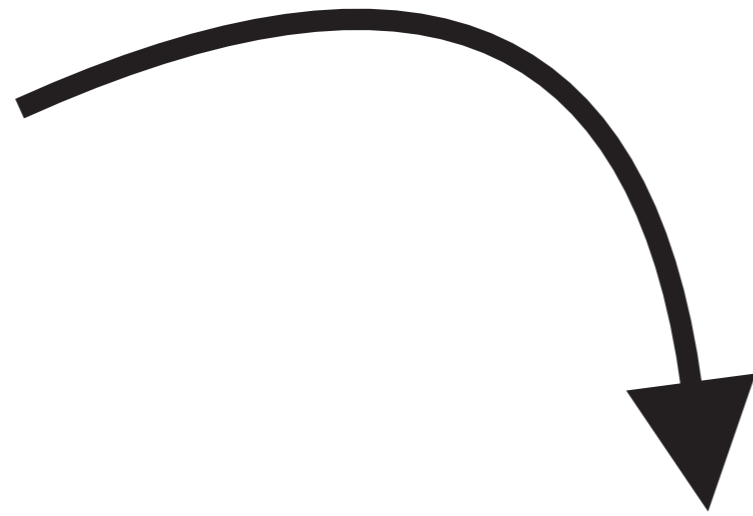
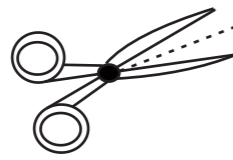

measuring

10cm

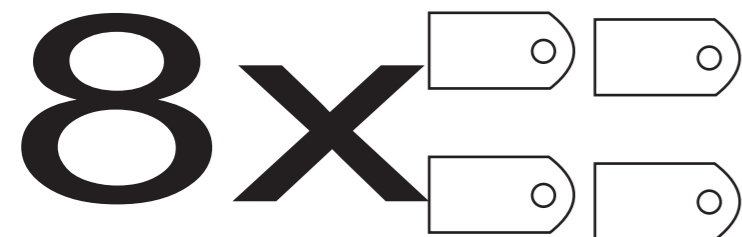
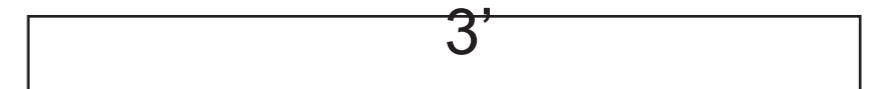
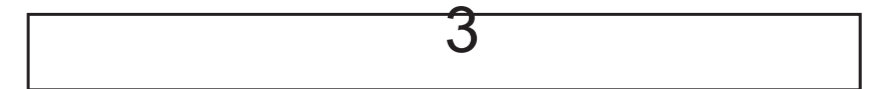
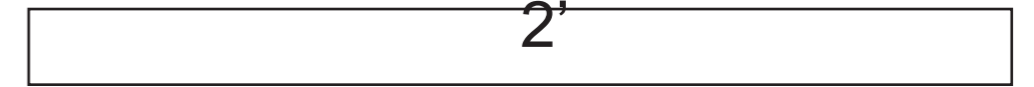
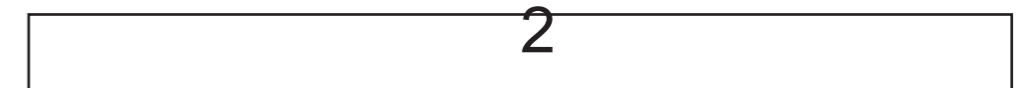
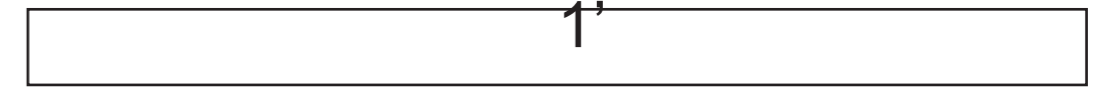
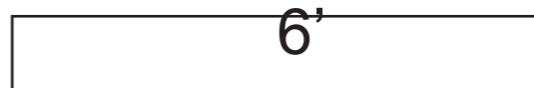
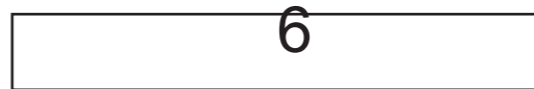
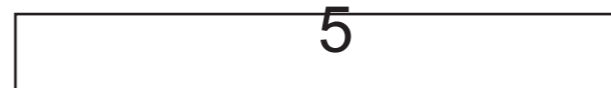
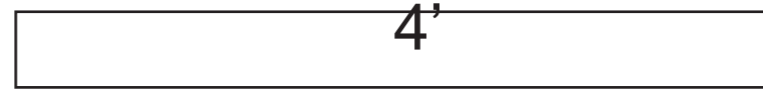
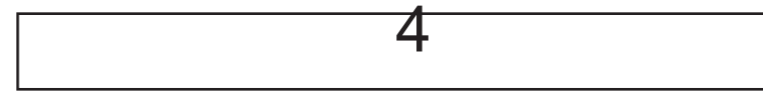
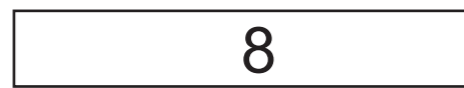
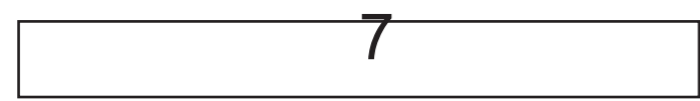
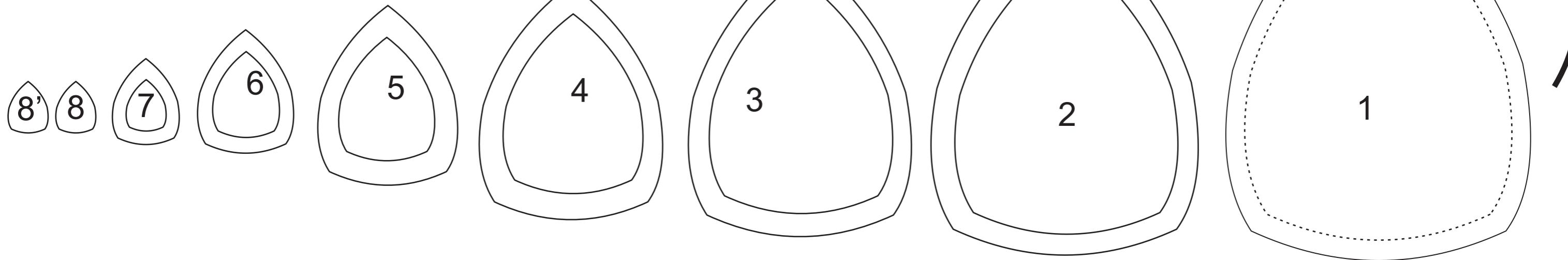
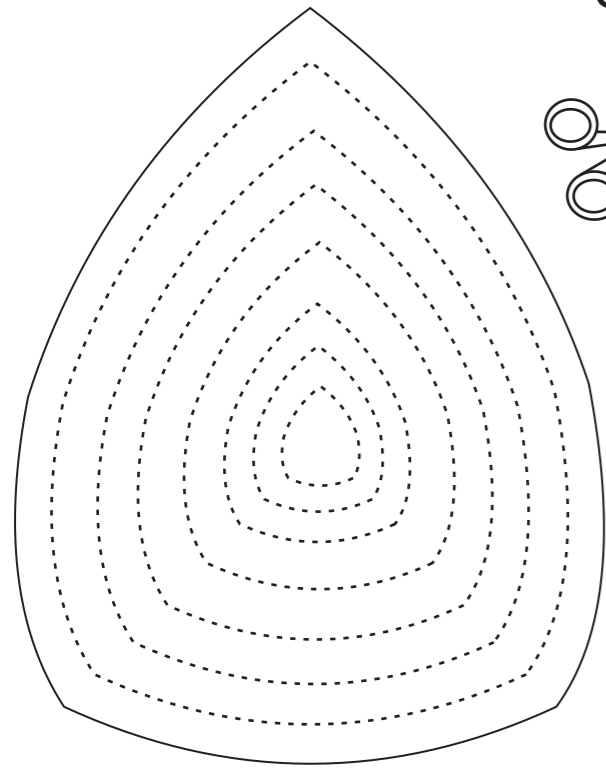
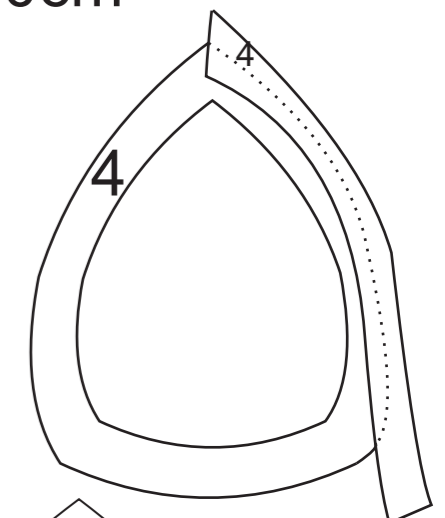

use this object  
for mold your  
water pipe pvc  
for making a body  
robo fish

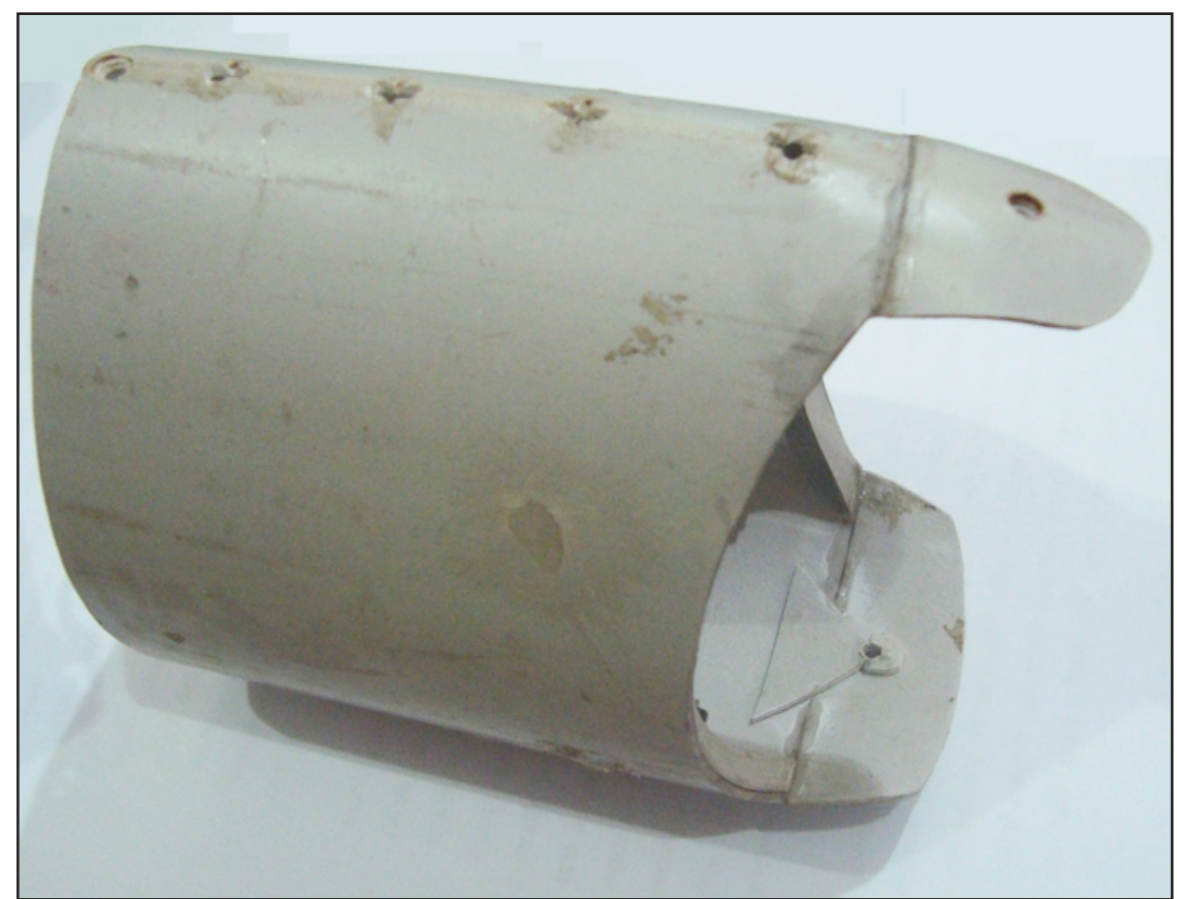
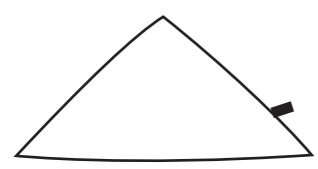
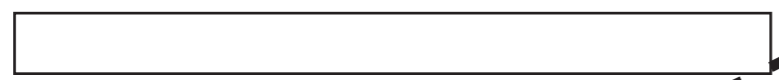
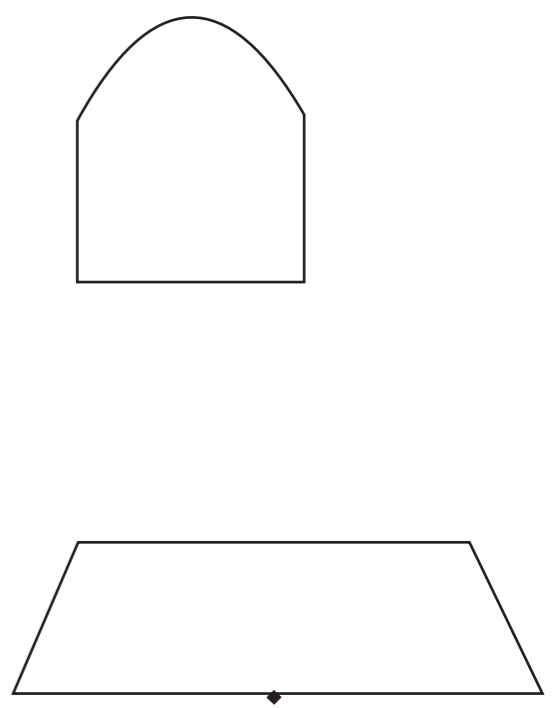
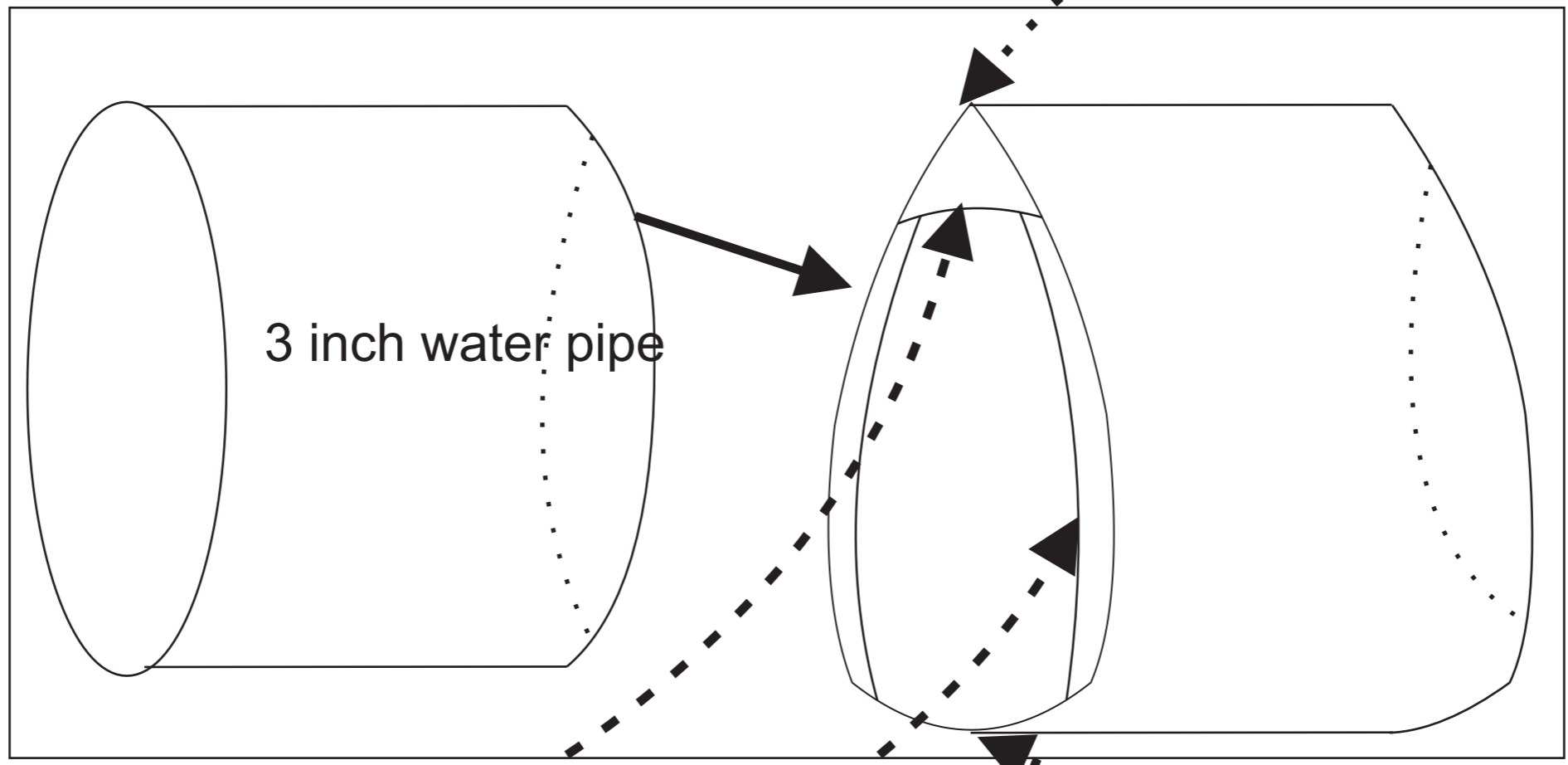

meansuring

10cm



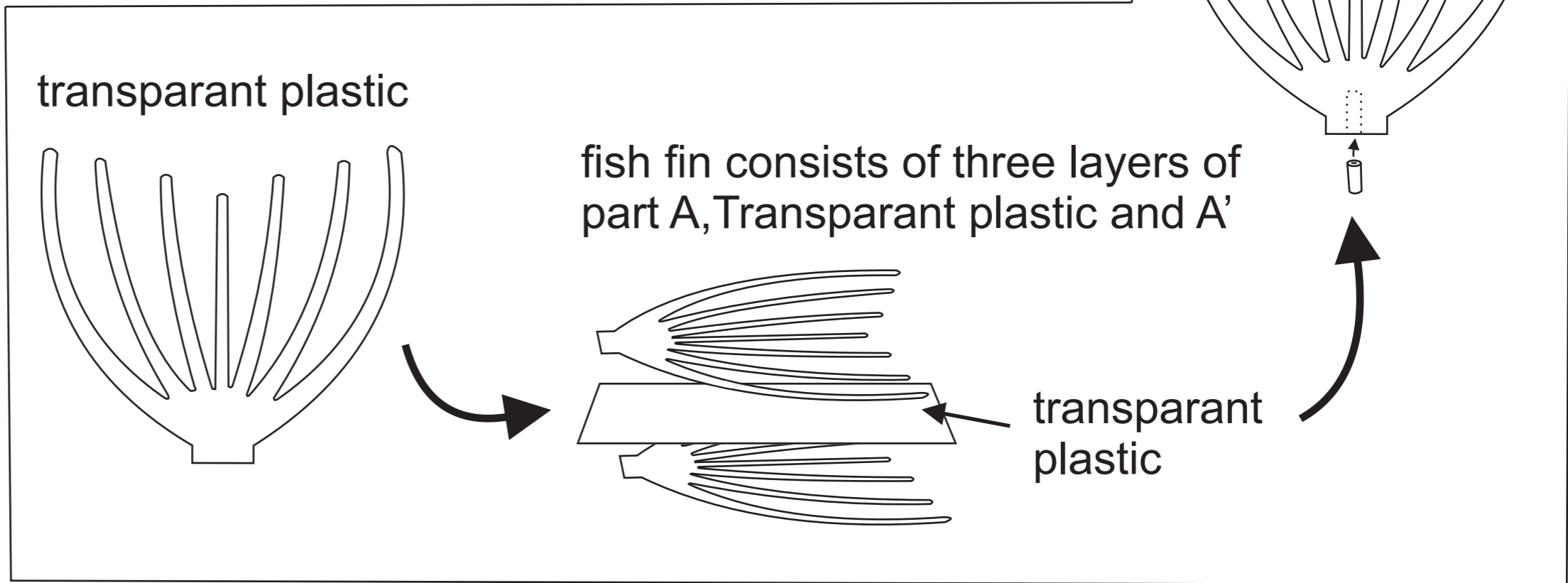
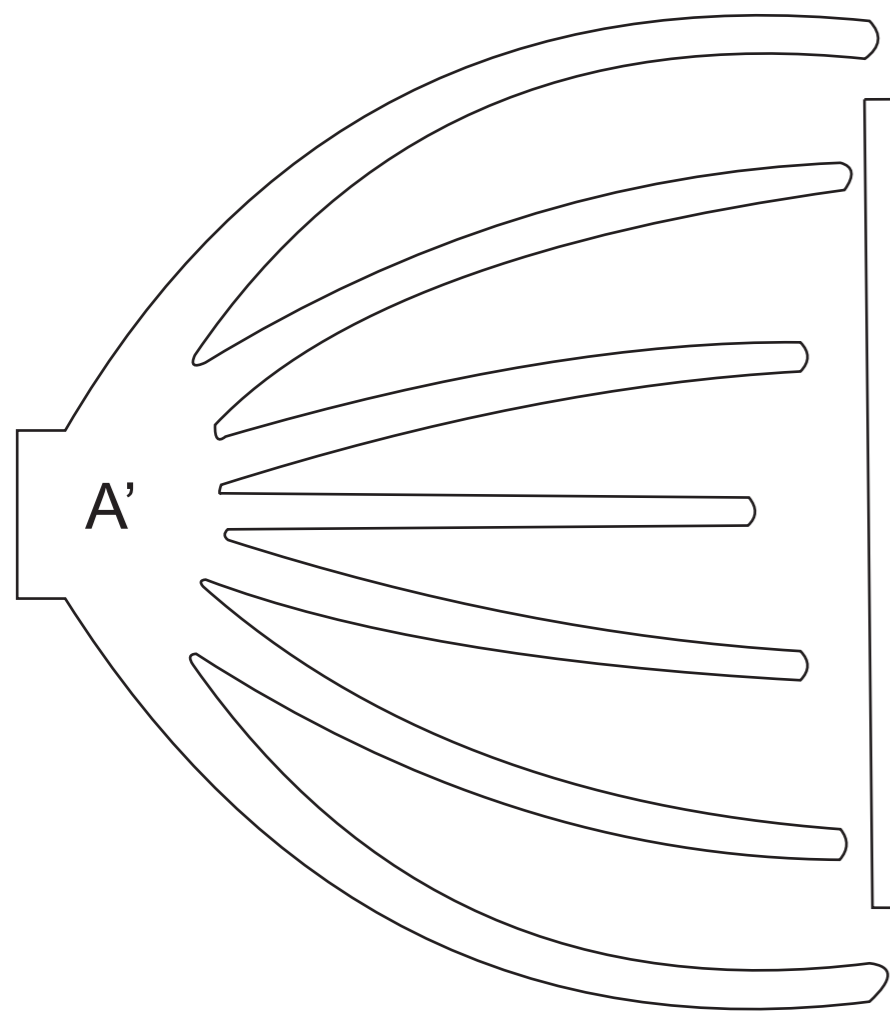
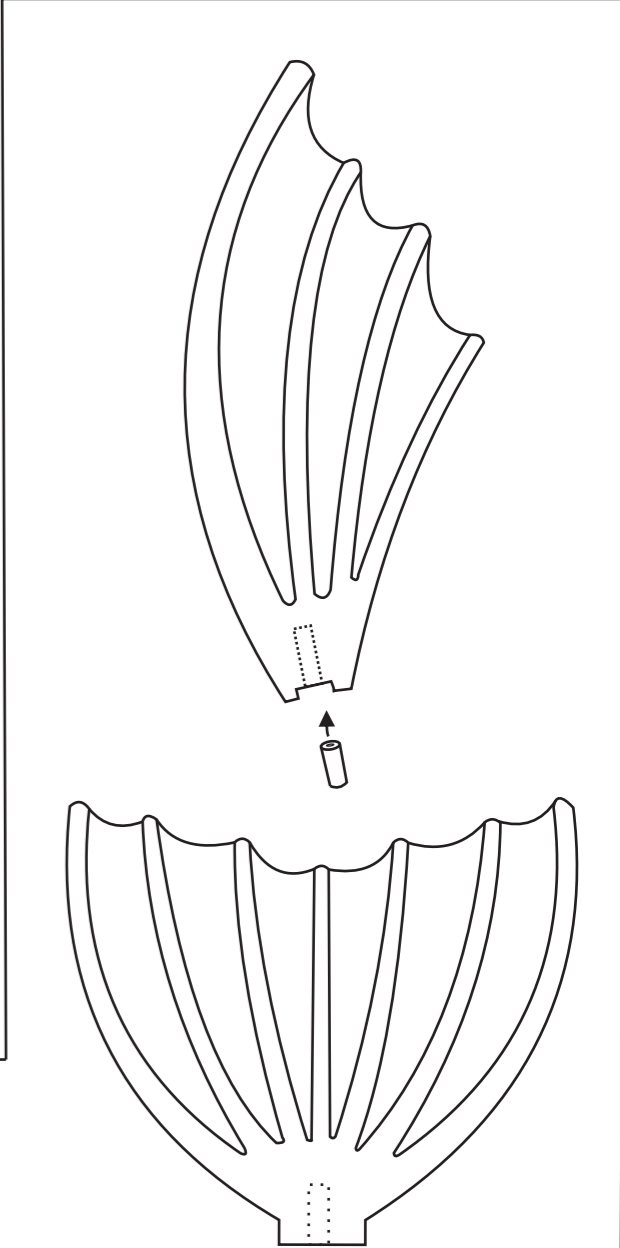
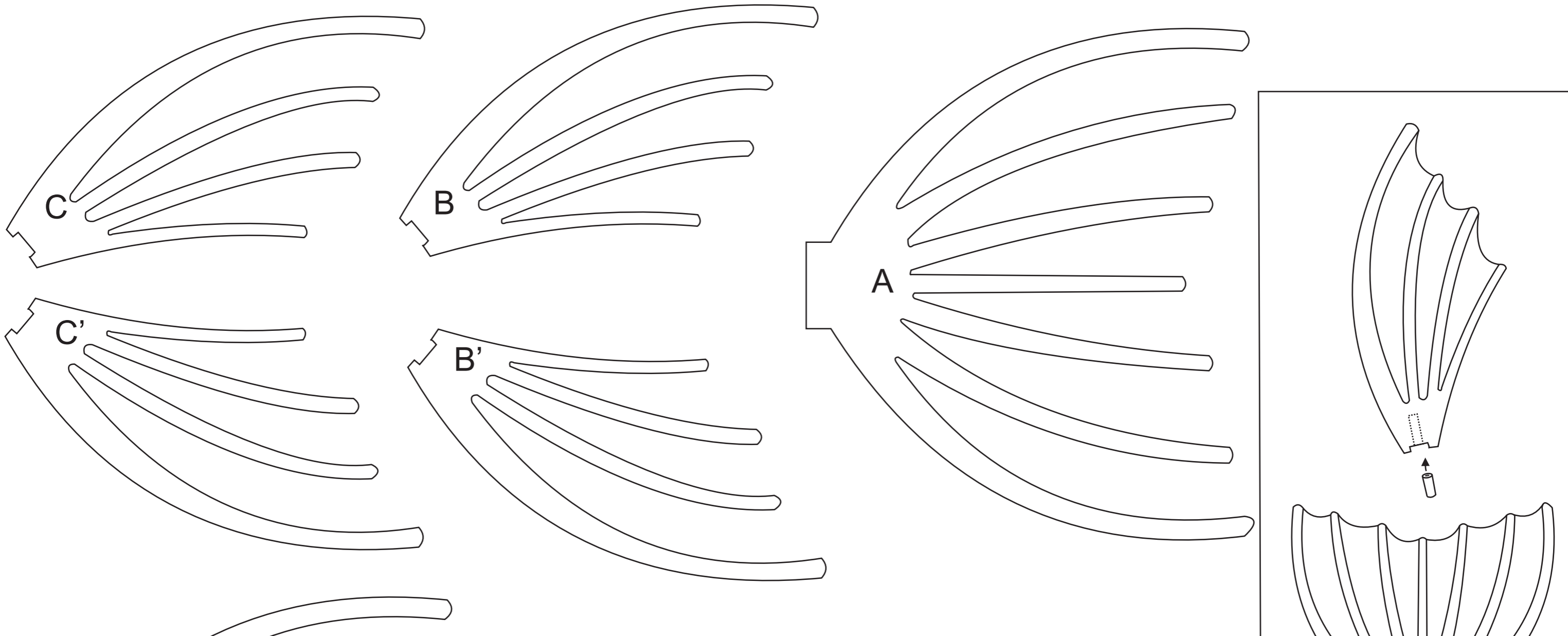

transparent plastic

fish fin consists of three layers of part A, Transparent plastic and A'

transparent plastic