

Alternately Occluding Dichoptic Modifier of Stereoscopic
Transmission 32 v0.50
User Manual

Index

Connecting AODMoST 32.....	2
User Interface.....	2
Resolutions and picture issues.....	3
Stereoscopy guide.....	3
Object types.....	5
Timings and frequencies when using Vsync different than 60Hz.....	6
Settings saving.....	6
Shape settings.....	7
Mask settings.....	7
Randomization settings.....	8
MODE 0: VIDEO PASS-THROUGH.....	11
MODE 1: TOP – BOTTOM.....	12
PAGE 0.....	12
PAGE 1.....	15
PAGE 2.....	16
PAGE 3.....	18
PAGE 4.....	20
PAGE 5.....	21
MODE 2: SIDE BY SIDE.....	23
PAGE 0.....	23
PAGE 1.....	26
PAGE 2.....	27
PAGE 3.....	29
PAGE 4.....	31
PAGE 5.....	32
MODE 3: NOT FINISHED YET.....	34

Connecting AODMoST 32

Plug VGA Input into your video source and VGA Output into 3D display. Preferably it should be done when all devices are turned off, but VGA generally can be hot plugged. If your video source or 3D display does not have VGA connector, you may use appropriate converter. Connect AODMoST 32 to a 5V USB port using the cable that has micro USB connector.

When everything is hooked up, turn on video source and 3D display. AODMoST after being powered on, at first enters synchronization pulse detection mode (indicated by a red NO SIGNAL LED being light up). When detection is completed and display starts receiving VGA signal, AODMoST enters MODE 0: VIDEO PASS-THROUGH.

If you hot plugged display, it may not be detected. Manually detecting display in display settings of video source should solve the problem.

User Interface

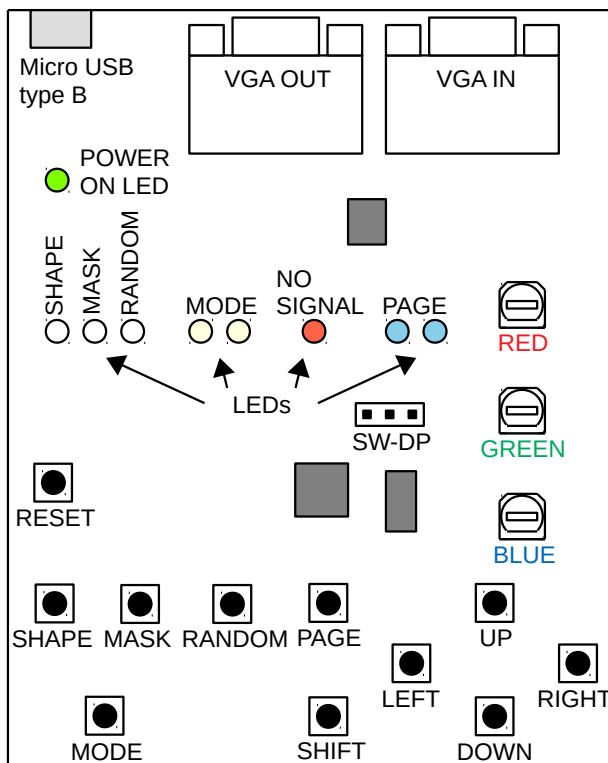

You may change MODE (there are 3 of them, they will be described in detail later) by pressing MODE button. Current mode is indicated by yellow MODE LEDs.

Pressing PAGE button changes PAGE to the next one (indicated by blue PAGE LEDs). Pressing SHIFT + PAGE buttons simultaneously changes page to the previous one.

Pressing MODE + PAGE at the same time restores default settings in all modes. Restoring singular settings will be described in detail on following pages of manual.

Adjusting trimpots changes color of overlay laid by AODMoST on top of video send to a display. There are 3 components to overlay color: RED, GREEN and BLUE. Each of them has a separate trimpot. Turning trimpot with screwdriver clockwise increases intensity of component color, turning it counterclockwise decreases insensitivity. Lowest intensity is achieved at the center position of trimpot.

AODMoST can store its settings in a non-volatile memory, so that they can be restored at the next device launch. It is done automatically after 10 seconds of no buttons being pressed.

Resolutions and picture issues

AODMoST 32 can work with resolutions up to 1920x1080 (and possibly even higher ones, but it has not been tested). If you are going to use 1080p screen to display lower resolution picture, I recommend that you use 720p, instead of something like 768p, as it should scale up better. Also, 3D content in TOP – BOTTOM format usually looks sharper than SIDE BY SIDE format.

Some configurations of objects that form overlay may cause artifacts on your display, try to avoid that. Placing objects beyond to the edges of a display may cause display to stop working temporarily, to resolve the issue press RESET or restore default settings. AODMoST 32 uses Watchdog Timer built in into its STM32F103C8T6 microcontroller, so it should automatically reset itself in case of its software failure. Reset also occurs during change of resolution.

Stereoscopy guide

AODMoST 32 can work with two types of 3D content:

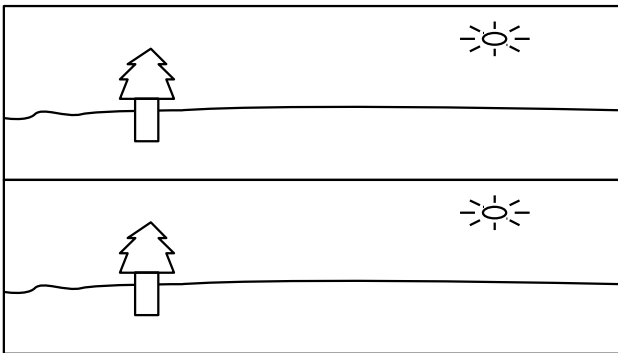

One of them is TOP – BOTTOM, where upper part of every video frame transmitted is supposed to be displayed exclusively to the one eye (usually the left one), and the lower part to the other.

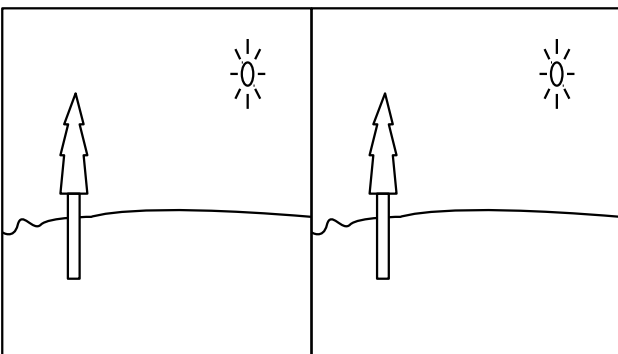

The other format is SIDE BY SIDE, where the left part of the picture is supposed to be displayed exclusively to the one eye (usually the left one), and the right part to the other.

When video source is generating 3D content in one of those two formats, you need to find an option in yours display menu that will activate correct 3D viewing mode, and possibly manually turn on 3D glasses.

When display's 3D mode is on, now both parts of the screen (those for the left and right eye) are enlarged to fit the whole screen and presented simultaneously to the corresponding eyes. It is achieved either with the use of passive technology (alternating rows of pixels emit light with different polarization, and then glasses with different filters for each eye separate them) or active shutter technology (display alternates between showing left image and right image using all pixels, and shutter glasses occlude the eye that is not supposed to see the image). Passive 3D uses cheaper and lighter glasses that do not contain any electronic circuits, but reduce resolution by half (AODMoST 32 can only use half of native resolution anyway) compared to the active shutter 3D.

When object (e.g. a ball) presented to the one eye is situated in the same place on the screen as this same object viewed by the other eye, then it is perceived as being at the same distance as the screen. When object viewed by the right eye is situated to the right of the object viewed by the left eye, then it is perceived as being located behind the screen. When object is viewed by the right eye is situated to the left of the object viewed by the left eye, then it is perceived as being located in front of the screen.

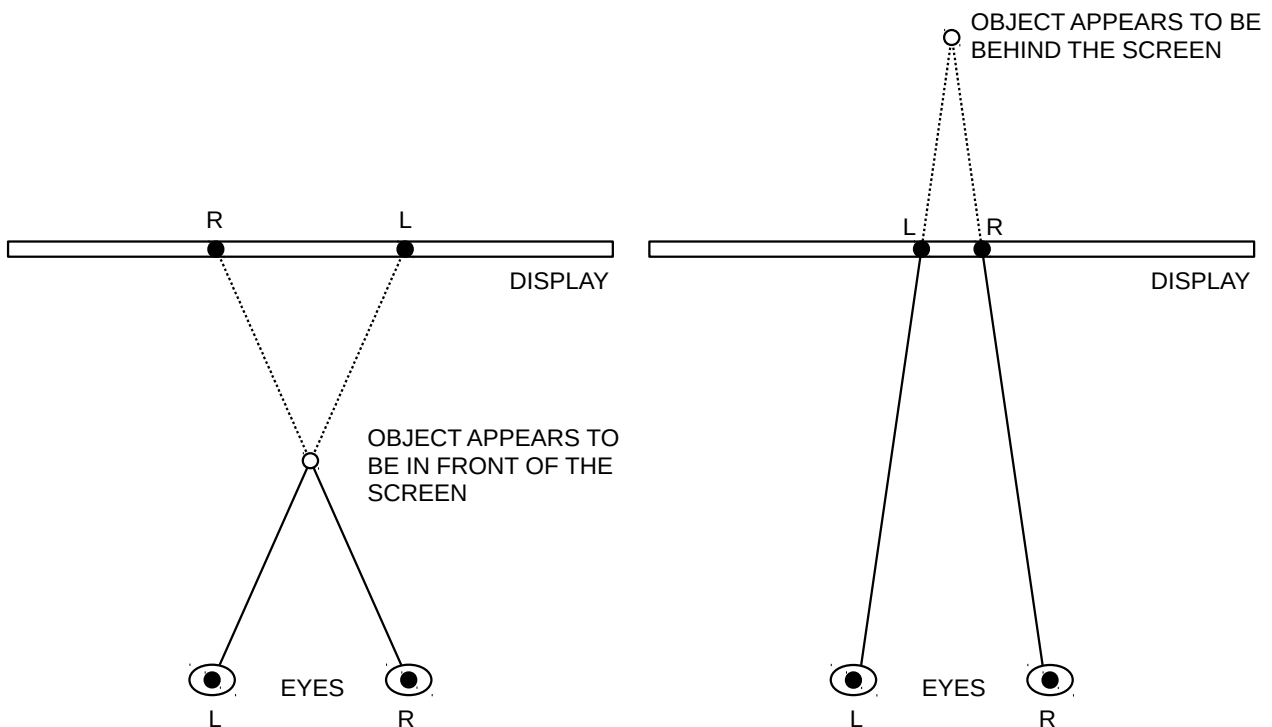

Distance between object's image dedicated to the left and right eyes is called parallax. When right eye's image stays on the right side of the screen, the parallax is positive. When right eye's image is on the left, then parallax is negative.

Maximum amount of parallax that lets the eyes focus on the images, while they are converged at the perceived distance is called comfort zone. When 3D display is viewed from a distance of 6-7 feet, the range of parallaxes that fit into comfort zone is from -1 inch to +1 inch. See this article for more details: [3D's "Immersive Experience" at Home: Why the home 3D experience will Not Rival that of the Theater](#)

Object types

This device draws video overlay that at one time consist of at most two objects. One of them, Alternately Occluding object (AO), is supposed to occupy most, if not all of the picture part that is dedicated to be seen by one of the eyes. Its shape is a rectangle (although when MASK setting is either 1 or 2 there is a hole inside AO object, shaped exactly like the DI object dedicated to be seen by the another eye). The other object is Dichoptic object (DI), which is supposed to be smaller than AO (it can never extend beyond the edges of AO displayed on the same part of the screen). DI can have one of three shapes: rectangle, cross, octagon (SHAPE setting decides which one, RANDOMIZATION settings can override it). DI's (or hole's in its shape) horizontal position on the lower/right part of the screen can also be offset to change perceived depth at which DI appears.

Both objects by default alternate between occupying one part of the screen and the other. You can change frequency of those alternations, occlusion rate (for what percentage of alternation cycle object occupies one part of the picture or another) or completely turn objects off. Their size and position can also be changed.

When AO and DI object occupy the same part of the screen, only AO object is visible.

Objects alternation cycle can sometimes be synchronized. It means that on some alternation cycle beginnings, AO and DI objects will occupy opposite parts of the screen, and later their alternations will be in resonance. It happens automatically, when alternation cycle duration of one object (the one that is longer) can be divided without rest by the duration of other's object alternation cycle. For example, when AO's cycle takes 8 frames (7.5Hz, 133,3ms) and DI's cycle takes 80 frames (0.75Hz, 1.333s), object will be synchronized because $80/8=10$, and 10 is a simple integer. Alternation cycle duration includes break(s).

Purpose of those object is too occlude part of a field of vision for one of the eyes, in order to force user's brain to utilize available visual information send by the other eye.

Timings and frequencies when using Vsync different than 60Hz

All times and frequencies found in this manual are given for 60Hz vertical synchronization frequency of video signal. If you are going to use other Vsync frequency, you need to use following formulas to convert values given in this manual:

$$T = \frac{60\text{Hz}}{f_{Vsync}} \cdot T_{\text{manual}}$$

$$f = \frac{f_{Vsync}}{60\text{Hz}} \cdot f_{\text{manual}}$$

Settings saving

This device stores settings when power is off to be loaded at the next start up. Settings are stored in microcontroller's Flash memory after settings are changed and 10 second [600 frames] period of no buttons being pressed passes. This process is indicated by the all LEDs lighting up for a short while. When there is no need to update Flash memory, red NO SIGNAL LED blinks every 10 seconds.

Flash memory is instantly updated when all settings are restored by pressing MODE + PAGE buttons.

Settings that correspond to the TOP – BOTTOM and SIDE BY SIDE modes are saved, as well as randomization settings. Selection of main mode, as well as Shape, Mask and Randomization modes, current settings page, are not saved.

Shape settings

DI object can take one of the three shapes. To change the shape press the SHAPE button. White SHAPE LED indicates which shape is currently used.

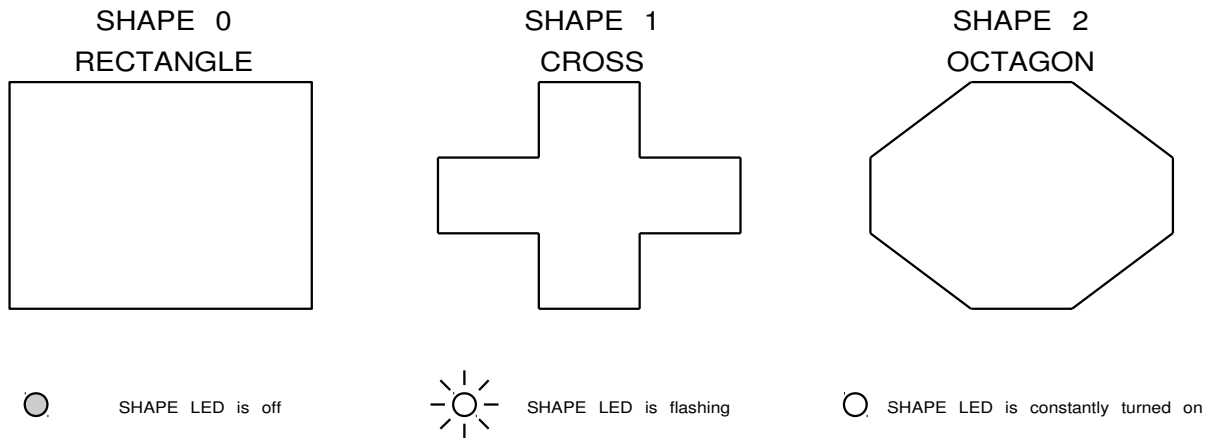





When Randomization of Shape is enabled, Randomization overrides basic Shape settings.

Mask settings

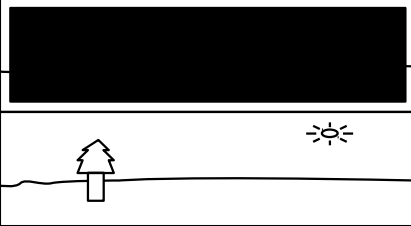
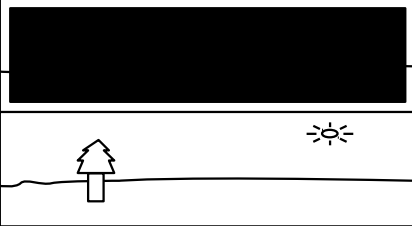
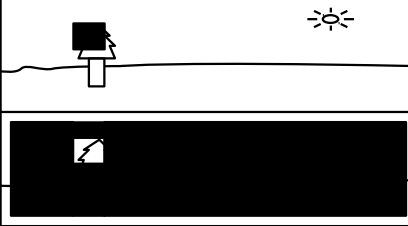
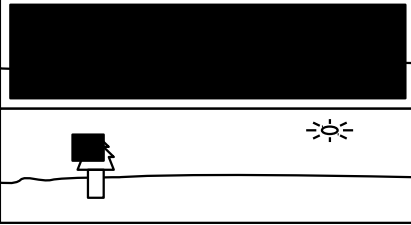
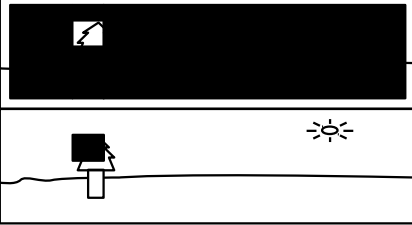
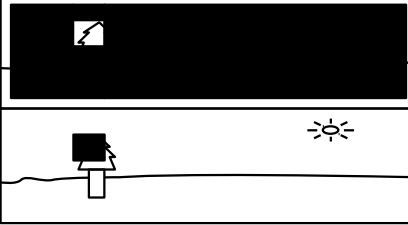
This setting allows to create a patterned image mask for one eye and inverse of this mask for the other eye, similarly for the patterned mask in this article: [Dichoptic movie viewing treats childhood amblyopia](#)

You can change mask setting by pressing the MASK button. White MASK LED indicates which patterned image mask type is currently used.

<p style="text-align: center;">MASK 0</p> <p style="text-align: center;">No patterned mask or inverse mask</p>	<p style="text-align: center;">MASK 1</p> <p style="text-align: center;">When DI is on the opposite part of the screen from AO, hole in the shape of DI is present inside AO</p>	<p style="text-align: center;">MASK 2</p> <p style="text-align: center;">AO settings are ignored, and when DI is present on one part of the screen, AO object with a hole is always present on the opposite side</p>
 <p style="text-align: center;">AO on top, DI on top</p>	 <p style="text-align: center;">AO on top, DI on top</p>	 <p style="text-align: center;">AO on top, DI on top</p>
 <p style="text-align: center;">AO on top, DI on bottom</p>	 <p style="text-align: center;">AO on top, DI on bottom</p>	 <p style="text-align: center;">AO on top, DI on bottom</p>
<p style="text-align: center;"> MASK LED is off</p>	<p style="text-align: center;"> MASK LED is flashing</p>	<p style="text-align: center;"> MASK LED is constantly turned on</p>

Randomization settings

Device can perform constant randomization of DI object's shape, position and size. There are three randomization modes, which can be changed by pressing the RANDOM button. White RANDOM LED indicates which mode is in use.

RANDOM MODE 0
Randomization is disabled.

 RANDOM LED is off

RANDOM MODE 1
Randomization settings are applied, six rightmost buttons are now used to change randomization settings, instead of performing their normal functions.

 RANDOM LED is flashing

RANDOM MODE 2
Randomization settings are applied, but they can not be changed because all buttons perform their normal functions.

 RANDOM LED is constantly turned on

There are spatial aspects of randomization settings which include how much can DI grow in size and how far DI can move from its initial position. The temporal settings specify how frequently those changes of DI's size and position happen and also how frequently DI changes shape. Those temporal aspect can be set independently of each other, and they are always synchronized and in resonance with each other.

BUTTONS	DESCRIPTION
Shape Randomization	
<p>PAGE increase shape randomization setting</p>	<p>There are four temporal settings of shape randomization:</p> <ul style="list-style-type: none"> • <u>0</u> – shape randomization is disabled • 1 – shape is changed every 2 DI's alternation cycles • 2 – shape is changed every 4 DI's alternation cycles • 3 – shape is changed every 8 DI's alternation cycles
<p>SHIFT + PAGE reset shape randomization setting (turn it off)</p>	
Position Randomization (temporal aspect)	
<p>UP increase temporal position randomization setting</p>	<p>There are four temporal settings of position randomization:</p> <ul style="list-style-type: none"> • <u>0</u> – position randomization is disabled • 1 – position is changed every 2 DI's alternation cycles • 2 – position is changed every 4 DI's alternation cycles • 3 – position is changed every 8 DI's alternation cycles
<p>DOWN decrease temporal position randomization setting</p>	
<p>UP + DOWN reset temporal position randomization setting (turn it off)</p>	
Position Randomization (spatial aspect)	
<p>SHIFT + UP increase spatial position randomization setting</p>	<p>There are four spatial settings of position randomization. Position can change vertically and horizontally. Change is calculated separately for both axis, which share common change limits.</p> <ul style="list-style-type: none"> • <u>0</u> – position randomization is disabled • 1 – position is changed at most by 1/4 of the distance to the closest AO's edge. • 2 – position is changed at most by 1/2 of the distance to the closest AO's edge. • 3 – position is changed at most by full distance to the closest AO's edge.
<p>SHIFT + DOWN decrease spatial position randomization setting</p>	
<p>SHIFT + UP + DOWN reset spatial position randomization setting (turn it off)</p>	

BUTTONS	DESCRIPTION
Size Randomization (temporal aspect)	
<p style="text-align: center;">LEFT</p> <p>increase temporal size randomization setting</p>	<p>There are four temporal settings of size randomization:</p> <ul style="list-style-type: none"> • <u>0</u> – size randomization is disabled • 1 – size is changed every 2 DI's alternation cycles • 2 – size is changed every 4 DI's alternation cycles • 3 – size is changed every 8 DI's alternation cycles
<p style="text-align: center;">RIGHT</p> <p>decrease temporal size randomization setting</p>	
<p style="text-align: center;">LEFT + RIGHT</p> <p>reset temporal size randomization setting (turn it off)</p>	
Size Randomization (spatial aspect)	
<p style="text-align: center;">SHIFT + LEFT</p> <p>increase spatial size randomization setting</p>	<p>There are four spatial settings of size randomization. Size can change vertically and horizontally. Change is calculated separately for both axis, which share common change limits.</p> <ul style="list-style-type: none"> • <u>0</u> – size randomization is disabled • 1 – size is changed at most by half of the original DI object size. • 2 – size is changed at most by whole original DI object size. • 3 – size is changed at most by two times original DI object size.
<p style="text-align: center;">SHIFT + RIGHT</p> <p>decrease spatial size randomization setting</p>	
<p style="text-align: center;">SHIFT + LEFT + RIGHT</p> <p>reset spatial size randomization setting (turn it off)</p>	
Randomization Settings Reset	
<p style="text-align: center;">UP + DOWN + LEFT + RIGHT</p>	<p>Pressing those buttons combinations will restore all randomization settings to their <u>default values</u>.</p>
<p style="text-align: center;">SHIFT + UP + DOWN + LEFT + RIGHT</p>	

To have position randomization enabled, both temporal and spatial aspects must be enabled. The same is true for size randomization.

MODE 0: VIDEO PASS-THROUGH

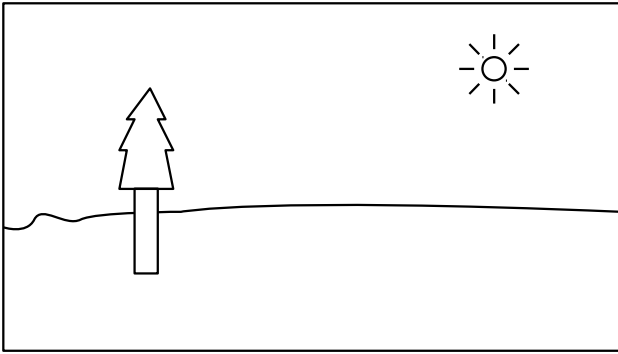

(both MODE LEDs are turned off)

AODMoST 32 always enters MODE 0 after its launch. You should keep device in this mode until your video source starts sending proper 3D material in Top – Bottom or Side By Side format. No objects are drawn upon video signal in this mode.

MODE 1: TOP – BOTTOM

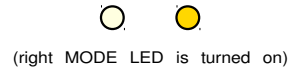
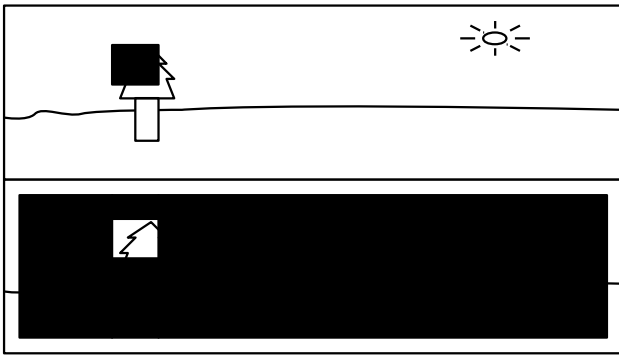



In MODE 1, AODMoST 32 draws two objects that alternate between occupying upper and lower part of the screen. Larger one, Alternately Occluding object (AO), after correct adjustment of settings, should take half or almost half of the screen. The smaller one, Dichoptic object (DI), always stays within the confines of alternately occluding object. Alternations between parts of the screen done by both objects are independent (except when MASK 2 is used). When both objects occupy the same part of the screen, Alternately Occluding object is the one visible.

When video source starts sending proper 3D material in Top – Bottom format (upper half of video is supposed to be shown to the one eye, usually the left one, lower part to the other eye), make adjustments of MODE 1 settings, so that Alternately Occluding objects occupy all or almost all area of the screen and Dichoptic object occludes chosen part of the screen. You may change frequency of alternations and which eye is occluded more (percentage of alternation cycle period by which each eye is occluded). When this is done, you should instruct your 3D display to generate 3D image, that can be viewed through 3D glasses (you most likely need to do it from your 3D display settings, they should be accessible by pressing MENU button on the remote control).



MODE 1 settings:

PAGE	BUTTONS	DESCRIPTION
<p style="text-align: center;">PAGE 0</p> <div style="text-align: center;">  <p>(both PAGE LEDs are turned off)</p> </div> <p style="text-align: center; font-size: small;">This PAGE contains general settings of Alternately Occluding Object</p>	<p>UP increase frequency</p>	<p style="text-align: center;">Alternately Occluding Object Frequency</p> <p style="text-align: center; font-size: x-small;">Available frequencies are:</p> <ul style="list-style-type: none"> • 15 Hz (U-50% : L-50%)* [4]** • 12 Hz (U-60% : L-40%)* [5]** • 10 Hz (U-50% : L-50%)* [6]** • <u>7.5 Hz</u> (U-50% : L-50%)* [8]** • 5 Hz (U-50% : L-50%)* [12]** • 2.5 Hz (U-50% : L-50%)* [24]** • 1.5 Hz (U-50% : L-50%)* [40]** <p style="font-size: x-small;">* default occlusion rate is set during change of frequency ** number of frames during which alternation cycle is concluded</p>
	<p>DOWN decrease frequency</p>	

PAGE	BUTTONS	DESCRIPTION	
<p style="text-align: center;">PAGE 0 (continued)</p> <div style="text-align: center;">  <p>(both PAGE LEDs are turned off)</p> </div> <p style="text-align: center;">This PAGE contains general settings of Alternately Occluding Object</p>	<p>Alternately Occluding Object Occlusion Rate (occlusions per Upper and Lower part of the screen)</p> <p>LEFT less occlusion of upper part</p>	<p style="text-align: center;">Available occlusion rates depend on current frequency:</p> <ul style="list-style-type: none"> • 15Hz <ul style="list-style-type: none"> ◦ U-0% : L-100% [0:4]** ◦ U-25% : L-75% [1:3]** ◦ <u>U-50% : L-50% [2:2]**</u> ◦ U-75% : L-25% [3:1]** ◦ U-100% : L-0% [4:0]** • 12Hz <ul style="list-style-type: none"> ◦ U-0% : L-100% [0:5]** ◦ U-20% : L-80% [1:4]** ◦ U-40% : L-60% [2:3]** ◦ <u>U-60% : L-40% [3:2]**</u> ◦ U-80% : L-20% [4:1]** ◦ U-100% : L-0% [5:0]** • 10Hz <ul style="list-style-type: none"> ◦ U-0% : L-100% [0:6]** ◦ U-16.7% : L-83.3% [1:5]** ◦ U-33.3% : L-66.7% [2:4]** ◦ <u>U-50% : L-50% [3:3]**</u> ◦ U-66.7% : L-33.3% [4:2]** ◦ U-83.3% : L-16.7% [5:1]** ◦ U-100% : L-0% [6:0]** • 7.5Hz <ul style="list-style-type: none"> ◦ U-0% : L-100% [0:8]** ◦ U-12.5% : L-87.5% [1:7]** ◦ U-25% : L-75% [2:6]** ◦ U-37.5% : L-62.5% [3:5]** ◦ <u>U-50% : L-50% [4:4]**</u> ◦ U-62.5% : L-37.5% [5:3]** ◦ U-75% : L-25% [6:2]** ◦ U-87.5% : L-12.5% [7:1]** ◦ U-100% : L-0% [8:0]** <ul style="list-style-type: none"> • 5Hz <ul style="list-style-type: none"> ◦ U-0% : L-100% [0:12]** ◦ U-8.3% : L-91.7% [1:11]** ◦ U-16.7% : L-83.3% [2:10]** ◦ U-25% : L-75% [3:9]** ◦ U-33.3% : L-66.7% [4:8]** ◦ U-41.7% : L-58.3% [5:7]** ◦ <u>U-50% : L-50% [6:6]**</u> ◦ U-58.3% : L-41.7% [7:5]** ◦ U-66.7% : L-33.3% [8:4]** ◦ U-75% : L-25% [9:3]** ◦ U-83.3% : L-16.7% [10:2]** ◦ U-91.7% : L-8.3% [11:1]** ◦ U-100% : L-0% [12:0]** • 2.5Hz <ul style="list-style-type: none"> ◦ U-0% : L-100% [0:24]** ◦ U-8.3% : L-91.7% [2:22]** ◦ U-16.7% : L-83.3% [4:20]** ◦ U-25% : L-75% [6:18]** ◦ U-33.3% : L-66.7% [8:16]** ◦ U-41.7% : L-58.3% [10:14]** ◦ <u>U-50% : L-50% [12:12]**</u> ◦ U-58.3% : L-41.7% [14:10]** ◦ U-66.7% : L-33.3% [16:8]** ◦ U-75% : L-25% [18:6]** ◦ U-83.3% : L-16.7% [20:4]** ◦ U-91.7% : L-8.3% [22:2]** ◦ U-100% : L-0% [24:0]** • 1.5Hz <ul style="list-style-type: none"> ◦ U-0% : L-100% [0:40]** ◦ U-10% : L-90% [4:36]** ◦ U-20% : L-80% [8:32]** ◦ U-30% : L-70% [12:28]** ◦ U-40% : L-60% [16:24]** ◦ <u>U-50% : L-50% [20:20]**</u> ◦ U-60% : L-40% [24:16]** ◦ U-70% : L-30% [28:12]** ◦ U-80% : L-20% [32:8]** ◦ U-90% : L-10% [36:4]** ◦ U-100% : L-0% [40:0]** <p style="text-align: right;">** number of frames during which AO occupies upper and lower part of the screen</p>	
	<p>RIGHT more occlusion of upper part</p>		
	<p>Alternately Occluding Object ON/OFF</p>		
	<p>SHIFT + UP toggle <u>on</u> /off state of the object</p>	<p>Alternately Occluding Object can be completely turned off and not being visible on screen.</p>	
<p>Alternately Occluding Object Gap</p>			
<p>SHIFT + LEFT decrease gap</p>	<p>Gap is the distance between two positions of alternately occluding object. By default it is <u>0</u>.</p>		
<p>SHIFT + RIGHT increase gap</p>			

PAGE	BUTTONS	DESCRIPTION
<p style="text-align: center;">PAGE 0 (continued)</p> <p style="text-align: center;">  (both PAGE LEDs are turned off) </p> <p style="text-align: center;"> This PAGE contains general settings of Alternately Occluding Object </p>	Alternately Occluding Object Break	
	SHIFT + DOWN increase AO break by 16.7ms [1 frame]	Break is time between AO object appearance on upper and lower parts of the screen when AO is not visible. When break exceeds its maximum value of 133.3ms [8 frames], set it to <u>0</u> . Increasing break increase total duration of alternation cycle.
	Restoring default settings	
	UP + DOWN set default frequency	Default alternately occluding object frequency is 7.5Hz (U-50% : L-50%)* *default occlusion rate is set during change of frequency
	LEFT + RIGHT set default occlusion rate	Default occlusion rates for different frequencies : <ul style="list-style-type: none"> • 15 Hz (<u>U-50%</u> : <u>L-50%</u>) [2:2]** • 12 Hz (<u>U-60%</u> : <u>L-40%</u>) [3:2]** • 10 Hz (<u>U-50%</u> : <u>L-50%</u>) [3:3]** • 7.5 Hz (<u>U-50%</u> : <u>L-50%</u>) [4:4]** • 5 Hz (<u>U-50%</u> : <u>L-50%</u>) [6:6]** • 2.5 Hz (<u>U-50%</u> : <u>L-50%</u>) [12:12]** • 1.5 Hz (<u>U-50%</u> : <u>L-50%</u>) [20:20]** ** number of frames during which AO occupies upper and lower part of the screen
	SHIFT + LEFT + RIGHT set default gap	Default alternately occluding object gap is <u>0</u>
	SHIFT + UP + DOWN set default on/off state of AO and its break	Default state is <u>ON</u> Default break is <u>0</u>
	UP + DOWN + LEFT + RIGHT restore default values for all settings from PAGE 0	<ul style="list-style-type: none"> • frequency: <u>7.5Hz</u> • occlusion rate: <u>U-50% : L-50%</u> • state: <u>ON</u> • break: <u>0</u> • gap: <u>0</u>
SHIFT + UP + DOWN + LEFT + RIGHT restore default values for all settings from MODE 1	Alternately Occluding Object: <ul style="list-style-type: none"> • frequency: <u>7.5Hz</u> • occlusion rate: <u>U-50% : L-50%</u> • state: <u>ON</u> • break: <u>0</u> • gap: <u>0</u> • default position and size • offset: <u>0</u> Dichoptic Object: <ul style="list-style-type: none"> • period: <u>2s</u> • occlusion rate: <u>U-50% : L-50%</u> • state: <u>ON</u> • break: <u>0</u> • offset: <u>0</u> • default position and size 	

PAGE	BUTTONS	DESCRIPTION
<p style="text-align: center;">PAGE 1</p> <div style="text-align: center;">  <p>(right PAGE LED is turned on)</p> </div> <p style="text-align: center;">This PAGE contains position settings of Alternately Occluding Object</p>	Position of Alternately Occluding Object	
	UP	position object higher up on screen
	SHIFT + UP	position object higher up on screen at increased speed
	DOWN	Position object lower down on screen
	SHIFT + DOWN	Position object lower down on screen at increased speed
	LEFT	Position object more to the left
	SHIFT + LEFT	Position object more to the left at increased speed
	RIGHT	Position object more to the right
	SHIFT + RIGHT	Position object more to the right at increased speed
	Alternately Occluding Object Offset	
	UP + LEFT move lower object more to the left	When offset is 0 , object's upper position is directly above the lower one. When offset is different than 0 , lower object is positioned more to the left or right compared to its default position. This should make object appear in front or behind the screen when viewed stereoscopically.
	SHIFT + UP + LEFT move lower object more to the left at increased speed	
	UP + RIGHT move lower object more to the right	
	SHIFT + UP + RIGHT move lower object more to the right at increased speed	
	Restoring default settings	
UP + DOWN SHIFT + UP + DOWN	Restore default vertical position of a object	
LEFT + RIGHT SHIFT + LEFT + RIGHT	Restore default horizontal position of a object	



PAGE	BUTTONS	DESCRIPTION
<p>PAGE 1 (continued)</p>  <p>(right PAGE LED is turned on)</p> <p>This PAGE contains position settings of Alternately Occluding Object</p>	UP + LEFT + RIGHT	Restore AO offset to the default value of 0
	UP + DOWN + LEFT + RIGHT restore default values for all settings from PAGE 1	Restore both vertical and horizontal position of a object, also the offset
	SHIFT + UP + DOWN + LEFT + RIGHT restore default values for all settings from MODE 1	<p>Alternately Occluding Object:</p> <ul style="list-style-type: none"> frequency: 7.5Hz occlusion rate: $U-50\% : L-50\%$ state: ON break: 0 gap: 0 default position and size offset: 0 <p>Dichoptic Object:</p> <ul style="list-style-type: none"> period: $2s$ occlusion rate: $U-50\% : L-50\%$ state: ON break: 0 offset: 0 default position and size
<p>PAGE 2</p>  <p>(left PAGE LED is turned on)</p> <p>This PAGE contains size settings of Alternately Occluding Object</p>	Size of Alternately Occluding Object	
	UP	Decrease vertical size of a object
	SHIFT + UP	Decrease vertical size of a object at increased speed
	DOWN	Increase vertical size of a object
	SHIFT + DOWN	Increase vertical size of a object at increased speed
	LEFT	Decrease horizontal size of a object
	SHIFT + LEFT	Decrease horizontal size of a object at increased speed
	RIGHT	Increase horizontal size of a object
	SHIFT + RIGHT	Increase horizontal size of a object at increased speed
	Restoring default settings	
	UP + DOWN SHIFT + UP + DOWN	Restore default vertical size of a object
	LEFT + RIGHT SHIFT + LEFT + RIGHT	Restore default horizontal size of a object

PAGE	BUTTONS	DESCRIPTION
<p>PAGE 2 (continued)</p>  <p>(left PAGE LED is turned on)</p> <p>This PAGE contains size settings of Alternately Occluding Object</p>	<p>UP + DOWN + LEFT + RIGHT restore default values for all settings from PAGE 2</p>	<p>Restore both vertical and horizontal size of a object</p>
	<p>SHIFT + UP + DOWN + LEFT + RIGHT restore default values for all settings from MODE 1</p>	<p>Alternately Occluding Object:</p> <ul style="list-style-type: none"> • frequency: <u>7.5Hz</u> • occlusion rate: <u>U-50% : L-50%</u> • state: <u>ON</u> • break: <u>0</u> • gap: <u>0</u> • default position and size • offset: <u>0</u> <p>Dichoptic Object:</p> <ul style="list-style-type: none"> • period: <u>2s</u> • occlusion rate: <u>U-50% : L-50%</u> • state: <u>ON</u> • break: <u>0</u> • offset: <u>0</u> • default position and size

PAGE	BUTTONS	DESCRIPTION
<p style="text-align: center;">PAGE 3</p> <div style="text-align: center;">  <p>(both PAGE LEDs are turned on)</p> </div> <p style="text-align: center;">This PAGE contains general settings of Dichoptic Object</p>	<p>UP decrease period</p> <hr/> <p>DOWN increase period</p>	<p style="text-align: center;">Dichoptic Object Period</p> <p style="text-align: center;">Available periods are:</p> <ul style="list-style-type: none"> • 0.4s (U-50% : L-50%)* [24]** • 0.67s (U-50% : L-50%)* [40]** • 1.33s (U-50% : L-50%)* [80]** • <u>2s</u> (U-50% : L-50%)* [120]** • 3.33s (U-50% : L-50%)* [200]** • 4.67s (U-50% : L-50%)* [280]** • 8s (U-50% : L-50%)* [480]** <p style="text-align: right;">* default occlusion rate is set during change of period ** number of frames during which alternation cycle is concluded</p>
	<p>LEFT less occlusion of upper part</p> <hr/> <p>RIGHT more occlusion of upper part</p>	<p style="text-align: center;">Dichoptic Object Occlusion Rate (occlusions per Upper and Lower part of the screen)</p> <p style="text-align: center;">Available occlusion rates depend on current period:</p> <ul style="list-style-type: none"> • 0.4s <ul style="list-style-type: none"> ◦ U-0% : L-100% [0:24]** ◦ U-25% : L-75% [6:18]** ◦ <u>U-50% : L-50% [12:12]**</u> ◦ U-75% : L-25% [18:6]** ◦ U-100% : L-0% [24:0]** • 0.67s <ul style="list-style-type: none"> ◦ U-0% : L-100% [0:40]** ◦ U-25% : L-75% [10:30]** ◦ <u>U-50% : L-50% [20:20]**</u> ◦ U-75% : L-25% [30:10]** ◦ U-100% : L-0% [40:0]** • 1.33s <ul style="list-style-type: none"> ◦ U-0% : L-100% [0:80]** ◦ U-25% : L-75% [20:60]** ◦ <u>U-50% : L-50% [40:40]**</u> ◦ U-75% : L-25% [60:20]** ◦ U-100% : L-0% [80:0]** • 2s <ul style="list-style-type: none"> ◦ U-0% : L-100% [0:120]** ◦ U-16.7% : L-83.3% [20:100]** ◦ U-33.3% : L-66.7% [40:80]** ◦ <u>U-50% : L-50% [60:60]**</u> ◦ U-66.7% : L-33.3% [80:40]** ◦ U-83.3% : L-16.7% [100:20]** ◦ U-100% : L-0% [120:0]** • 3.33s <ul style="list-style-type: none"> ◦ U-0% : L-100% [0:200]** ◦ U-10% : L-90% [20:180]** ◦ U-20% : L-80% [40:160]** ◦ U-30% : L-70% [60:140]** ◦ U-40% : L-60% [80:120]** ◦ <u>U-50% : L-50% [100:100]**</u> ◦ U-60% : L-40% [120:80]** ◦ U-70% : L-30% [140:60]** ◦ U-80% : L-20% [160:40]** ◦ U-90% : L-10% [180:20]** ◦ U-100% : L-0% [200:0]** • 4.67s <ul style="list-style-type: none"> ◦ U-0% : L-100% [0:280]** ◦ U-7.1% : L-92.9% [20:260]** ◦ U-14.3% : L-85.7% [40:240]** ◦ U-21.4% : L-78.6% [60:220]** ◦ U-28.6% : L-71.4% [80:200]** ◦ U-35.7% : L-64.3% [100:180]** ◦ U-42.9% : L-57.1% [120:160]** ◦ <u>U-50% : L-50% [140:140]**</u> ◦ U-57.1% : L-42.9% [160:120]** ◦ U-64.3% : L-35.7% [180:100]** ◦ U-71.4% : L-28.6% [200:80]** ◦ U-78.6% : L-21.4% [220:60]** ◦ U-85.7% : L-14.3% [240:40]** ◦ U-92.9% : L-7.1% [260:20]** ◦ U-100% : L-0% [280:0]** • 4.67s <ul style="list-style-type: none"> ◦ U-0% : L-100% [0:480]** ◦ U-8.3% : L-91.7% [40:440]** ◦ U-16.7% : L-83.3% [80:400]** ◦ U-25% : L-75% [120:360]** ◦ U-33.3% : L-66.7% [160:320]** ◦ U-41.7% : L-58.3% [200:280]** ◦ <u>U-50% : L-50% [240:240]**</u> ◦ U-58.3% : L-41.7% [280:200]** ◦ U-66.7% : L-33.3% [320:160]** ◦ U-75% : L-25% [360:120]** ◦ U-83.3% : L-16.7% [400:80]** ◦ U-91.7% : L-8.3% [440:40]** ◦ U-100% : L-0% [480:0]** <p style="text-align: right;">** number of frames during which DI occupies upper and lower part of the screen</p>
	<p>Dichoptic Object ON/OFF</p>	<p>SHIFT + UP toggle <u>on</u> /off state of the object</p> <p>Dichoptic Object can be completely turned off and not being visible on screen.</p>

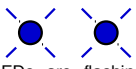
PAGE	BUTTONS	DESCRIPTION
<p style="text-align: center;">PAGE 3 (continued)</p> <p style="text-align: center;">● ●</p> <p>(both PAGE LEDs are turned on)</p> <p>This PAGE contains general settings of Dichoptic Object</p>	Dichoptic Object Offset	
	SHIFT + LEFT lower object more to the left	When offset is $\underline{0}$, object's upper position is directly above the lower one. When offset is different than $\underline{0}$, lower object is positioned more to the left or right compared to its default position. This should make object appear in front or behind the screen when viewed stereoscopically.
	SHIFT + RIGHT lower object more to the right	
	Dichoptic Object Break	
	SHIFT + DOWN increase DI break	Break is time between DI object appearance on upper and lower parts of the screen when DI is not visible. When break exceeds its maximum value, set it to $\underline{0}$. Increasing break increase total duration of alternation cycle. Break is incremented differently when different periods are used: <ul style="list-style-type: none"> • 0.4s – increment: 0.2s [12]**; maximum 0.8s [48]** • 0.67s – increment: 0.33s [20]**; maximum 1.33s [80]** • 1.33s – increment: 0.33s [20]**; maximum 1.33s [80]** • 2s – increment: 0.33s [20]**; maximum 1.33s [80]** • 3.33s – increment: 0.33s [20]**; maximum 1.33s [80]** • 4.67s – increment: 0.33s [20]**; maximum 1.33s [80]** • 8s – increment: 0.67s [40]**; maximum 2.67s [160]** ** number of frames
	Restoring default settings	
	UP + DOWN set default frequency	Default dichoptic object period is $\underline{2s}$ (U-50% : L-50%)* *default occlusion rate is set during change of period
	LEFT + RIGHT set default occlusion rate	Default occlusion rates for different periods : <ul style="list-style-type: none"> • 0.4s (U-50% : L-50%) [12:12]** • 0.67s (U-50% : L-50%) [20:20]** • 1.33s (U-50% : L-50%) [40:40]** • 2s (U-50% : L-50%) [60:60]** • 3.33s (U-50% : L-50%) [100:100]** • 4.67 (U-50% : L-50%) [140:140]** • 8s (U-50% : L-50%) [240:240]** ** number of frames during which DI occupies upper and lower part of the screen
SHIFT + LEFT + RIGHT set default offset	Default dichoptic object offset is $\underline{0}$.	
SHIFT + UP + DOWN set default on/off state of DI and its break	Default state is \underline{ON} Default break is $\underline{0}$	

PAGE	BUTTONS	DESCRIPTION
<p style="text-align: center;">PAGE 3 (continued)</p> <div style="text-align: center;">  </div> <p style="text-align: center;">(both PAGE LEDs are turned on)</p> <p style="text-align: center;">This PAGE contains general settings of Dichoptic Object</p>	<p style="text-align: center;">UP + DOWN + LEFT + RIGHT restore default values for all settings from PAGE 3</p>	<ul style="list-style-type: none"> • period: <u>2s</u> • occlusion rate: <u>U-50% : L-50%</u> • state: <u>ON</u> • break: <u>0</u> • offset: <u>0</u>
	<p style="text-align: center;">SHIFT + UP + DOWN + LEFT + RIGHT restore default values for all settings from MODE 1</p>	<ul style="list-style-type: none"> Alternately Occluding Object: • frequency: <u>7.5Hz</u> • occlusion rate: <u>U-50% : L-50%</u> • state: <u>ON</u> • break: <u>0</u> • gap: <u>0</u> • default position and size • offset: <u>0</u> Dichoptic Object: • period: <u>2s</u> • occlusion rate: <u>U-50% : L-50%</u> • state: <u>ON</u> • break: <u>0</u> • offset: <u>0</u> • default position and size
<p style="text-align: center;">PAGE 4</p> <div style="text-align: center;">  </div> <p style="text-align: center;">(PAGE LEDs are flashing at low frequency)</p> <p style="text-align: center;">This PAGE contains position settings of Dichoptic Object</p>	Position of Dichoptic Object	
	UP	Position object higher up on screen
	SHIFT + UP	Position object higher up on screen at increased speed
	DOWN	Position object lower down on screen
	SHIFT + DOWN	Position object lower down on screen at increased speed
	LEFT	Position object more to the left
	SHIFT + LEFT	Position object more to the left at increased speed
	RIGHT	Position object more to the right
	SHIFT + RIGHT	Position object more to the right at increased speed
	Restoring default settings	
	UP + DOWN SHIFT + UP + DOWN	Restore default vertical size of a object
	LEFT + RIGHT SHIFT + LEFT + RIGHT	Restore default horizontal size of a object

PAGE	BUTTONS	DESCRIPTION
<p>PAGE 4 (continued)</p>  <p>(PAGE LEDs are flashing at low frequency)</p> <p>This PAGE contains position settings of Dichoptic Object</p>	<p>UP + DOWN + LEFT + RIGHT restore default values for all settings from PAGE 4</p>	<p>Restore both vertical and horizontal size of a object</p>
	<p>SHIFT + UP + DOWN + LEFT + RIGHT restore default values for all settings from MODE 1</p>	<p>Alternately Occluding Object:</p> <ul style="list-style-type: none"> • frequency: <u>7.5Hz</u> • occlusion rate: <u>U-50% : L-50%</u> • state: <u>ON</u> • break: <u>0</u> • gap: <u>0</u> • default position and size • offset: <u>0</u> <p>Dichoptic Object:</p> <ul style="list-style-type: none"> • period: <u>2s</u> • occlusion rate: <u>U-50% : L-50%</u> • state: <u>ON</u> • break: <u>0</u> • offset: <u>0</u> • default position and size
<p>PAGE 5</p>  <p>(PAGE LEDs are flashing at high frequency)</p> <p>This PAGE contains size settings of Dichoptic Object</p>	<p>Size of Dichoptic Object</p>	
	<p>UP</p>	<p>Decrease vertical size of a object</p>
	<p>SHIFT + UP</p>	<p>Decrease vertical size of a object at increased speed</p>
	<p>DOWN</p>	<p>Increase vertical size of a object</p>
	<p>SHIFT + DOWN</p>	<p>Increase vertical size of a object at increased speed</p>
	<p>LEFT</p>	<p>Decrease horizontal size of a object</p>
	<p>SHIFT + LEFT</p>	<p>Decrease horizontal size of a object at increased speed</p>
	<p>RIGHT</p>	<p>Increase horizontal size of a object</p>
	<p>SHIFT + RIGHT</p>	<p>Increase horizontal size of a object at increased speed</p>
	<p>Restoring default settings</p>	
	<p>UP + DOWN SHIFT + UP + DOWN</p>	<p>Restore default vertical size of a object</p>
	<p>LEFT + RIGHT SHIFT + LEFT + RIGHT</p>	<p>Restore default horizontal size of a object</p>

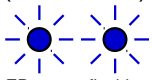
PAGE	BUTTONS	DESCRIPTION
<p>PAGE 5 (continued)</p>  <p>(PAGE LEDs are flashing at high frequency)</p> <p>This PAGE contains size settings of Dichoptic Object</p>	<p>UP + DOWN + LEFT + RIGHT restore default values for all settings from PAGE 5</p> <hr/> <p>SHIFT + UP + DOWN + LEFT + RIGHT restore default values for all settings from MODE 1</p>	<p>Restore both vertical and horizontal size of a object</p> <hr/> <p>Alternately Occluding Object:</p> <ul style="list-style-type: none"> • frequency: <u>7.5Hz</u> • occlusion rate: <u>U-50% : L-50%</u> • state: <u>ON</u> • break: <u>0</u> • gap: <u>0</u> • default position and size • offset: <u>0</u> <p>Dichoptic Object:</p> <ul style="list-style-type: none"> • period: <u>2s</u> • occlusion rate: <u>U-50% : L-50%</u> • state: <u>ON</u> • break: <u>0</u> • offset: <u>0</u> • default position and size

Numbers that are in italics and are underlined are the default values

MODE 2: SIDE BY SIDE

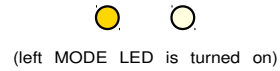
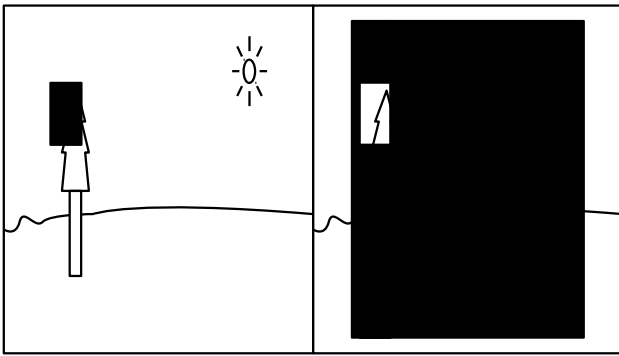



In MODE 2, AODMoST 32 draws two objects that alternate between occupying left and right part of the screen. Larger one, Alternately Occluding object (AO), after correct adjustment of settings, should take half or almost half of the screen. The smaller one, Dichoptic object (DI), always stays within the confines of alternately occluding object. Alternations between parts of the screen done by both objects are independent (except when MASK 2 is used). When both objects occupy the same part of the screen, Alternately Occluding object is the one visible.



When video source starts sending proper 3D material in Side By Side format (left half of video is supposed to be shown to the one eye, usually the left one, right part to the other eye), make adjustments of MODE 2 settings, so that Alternately Occluding objects occupy all or almost all area of the screen and Dichoptic object occludes chosen part of the screen. You may change frequency of alternations and which eye is occluded more (percentage of alternation cycle period by which each eye is occluded). When this is done, you should instruct your 3D display to generate 3D image, that can be viewed through 3D glasses (you most likely need to do it from your 3D display settings, they should be accessible by pressing MENU button on the remote control).



MODE 2 settings:

PAGE	BUTTONS	DESCRIPTION
<p>PAGE 0</p>  <p>(both PAGE LEDs are turned off)</p> <p>This PAGE contains general settings of Alternately Occluding Object</p>	<p>UP increase frequency</p>	<p>Available frequencies are:</p> <ul style="list-style-type: none"> • 15 Hz (U-50% : L-50%)* [4]** • 12 Hz (U-60% : L-40%)* [5]** • 10 Hz (U-50% : L-50%)* [6]** • <u>7.5 Hz</u> (U-50% : L-50%)* [8]** • 5 Hz (U-50% : L-50%)* [12]** • 2.5 Hz (U-50% : L-50%)* [24]** • 1.5 Hz (U-50% : L-50%)* [40]** <p>* default occlusion rate is set during change of frequency ** number of frames during which alternation cycle is concluded</p>
	<p>DOWN decrease frequency</p>	

PAGE	BUTTONS	DESCRIPTION	
<p style="text-align: center;">PAGE 0 (continued)</p> <div style="text-align: center;">  <p>(both PAGE LEDs are turned off)</p> </div> <p style="text-align: center;">This PAGE contains general settings of Alternately Occluding Object</p>	<p>Alternately Occluding Object Occlusion Rate (occlusions per Upper and Lower part of the screen)</p> <p>LEFT less occlusion of upper part</p>	<p style="text-align: center;">Available occlusion rates depend on current frequency:</p> <ul style="list-style-type: none"> • 15Hz <ul style="list-style-type: none"> ◦ U-0% : L-100% [0:4]** ◦ U-25% : L-75% [1:3]** ◦ <u>U-50% : L-50% [2:2]**</u> ◦ U-75% : L-25% [3:1]** ◦ U-100% : L-0% [4:0]** • 12Hz <ul style="list-style-type: none"> ◦ U-0% : L-100% [0:5]** ◦ U-20% : L-80% [1:4]** ◦ U-40% : L-60% [2:3]** ◦ <u>U-60% : L-40% [3:2]**</u> ◦ U-80% : L-20% [4:1]** ◦ U-100% : L-0% [5:0]** • 10Hz <ul style="list-style-type: none"> ◦ U-0% : L-100% [0:6]** ◦ U-16.7% : L-83.3% [1:5]** ◦ U-33.3% : L-66.7% [2:4]** ◦ <u>U-50% : L-50% [3:3]**</u> ◦ U-66.7% : L-33.3% [4:2]** ◦ U-83.3% : L-16.7% [5:1]** ◦ U-100% : L-0% [6:0]** • 7.5Hz <ul style="list-style-type: none"> ◦ U-0% : L-100% [0:8]** ◦ U-12.5% : L-87.5% [1:7]** ◦ U-25% : L-75% [2:6]** ◦ U-37.5% : L-62.5% [3:5]** ◦ <u>U-50% : L-50% [4:4]**</u> ◦ U-62.5% : L-37.5% [5:3]** ◦ U-75% : L-25% [6:2]** ◦ U-87.5% : L-12.5% [7:1]** ◦ U-100% : L-0% [8:0]** • 5Hz <ul style="list-style-type: none"> ◦ U-0% : L-100% [0:12]** ◦ U-8.3% : L-91.7% [1:11]** ◦ U-16.7% : L-83.3% [2:10]** ◦ U-25% : L-75% [3:9]** ◦ U-33.3% : L-66.7% [4:8]** ◦ U-41.7% : L-58.3% [5:7]** ◦ <u>U-50% : L-50% [6:6]**</u> ◦ U-58.3% : L-41.7% [7:5]** ◦ U-66.7% : L-33.3% [8:4]** ◦ U-75% : L-25% [9:3]** ◦ U-83.3% : L-16.7% [10:2]** ◦ U-91.7% : L-8.3% [11:1]** ◦ U-100% : L-0% [12:0]** • 2.5Hz <ul style="list-style-type: none"> ◦ U-0% : L-100% [0:24]** ◦ U-8.3% : L-91.7% [2:22]** ◦ U-16.7% : L-83.3% [4:20]** ◦ U-25% : L-75% [6:18]** ◦ U-33.3% : L-66.7% [8:16]** ◦ U-41.7% : L-58.3% [10:14]** ◦ <u>U-50% : L-50% [12:12]**</u> ◦ U-58.3% : L-41.7% [14:10]** ◦ U-66.7% : L-33.3% [16:8]** ◦ U-75% : L-25% [18:6]** ◦ U-83.3% : L-16.7% [20:4]** ◦ U-91.7% : L-8.3% [22:2]** ◦ U-100% : L-0% [24:0]** • 1.5Hz <ul style="list-style-type: none"> ◦ U-0% : L-100% [0:40]** ◦ U-10% : L-90% [4:36]** ◦ U-20% : L-80% [8:32]** ◦ U-30% : L-70% [12:28]** ◦ U-40% : L-60% [16:24]** ◦ <u>U-50% : L-50% [20:20]**</u> ◦ U-60% : L-40% [24:16]** ◦ U-70% : L-30% [28:12]** ◦ U-80% : L-20% [32:8]** ◦ U-90% : L-10% [36:4]** ◦ U-100% : L-0% [40:0]** <p style="text-align: right;">** number of frames during which AO occupies upper and lower part of the screen</p>	
	<p>RIGHT more occlusion of upper part</p>		
	<p>Alternately Occluding Object ON/OFF</p>		
	<p>SHIFT + UP toggle <u>on</u> /off state of the object</p>	<p>Alternately Occluding Object can be completely turned off and not being visible on screen.</p>	
<p>Alternately Occluding Object Gap</p>			
<p>SHIFT + LEFT decrease gap</p>	<p>Gap is the distance between two positions of alternately occluding object. By default it is <u>0</u>.</p>		
<p>SHIFT + RIGHT increase gap</p>			

PAGE	BUTTONS	DESCRIPTION
<p style="text-align: center;">PAGE 0 (continued)</p> <p style="text-align: center;">  (both PAGE LEDs are turned off) </p> <p style="text-align: center;">This PAGE contains general settings of Alternately Occluding Object</p>	Alternately Occluding Object Break	
	SHIFT + DOWN increase AO break by 16.7ms [1 frame]	Break is time between AO object appearance on upper and lower parts of the screen when AO is not visible. When break exceeds its maximum value of 133.3ms [8 frames], set it to <u>0</u> . Increasing break increase total duration of alternation cycle.
	Restoring default settings	
	UP + DOWN set default frequency	Default alternately occluding object frequency is 7.5Hz (U-50% : L-50%)* *default occlusion rate is set during change of frequency
	LEFT + RIGHT set default occlusion rate	Default occlusion rates for different frequencies : <ul style="list-style-type: none"> • 15 Hz (<u>U-50%</u> : <u>L-50%</u>) [2:2]** • 12 Hz (<u>U-60%</u> : <u>L-40%</u>) [3:2]** • 10 Hz (<u>U-50%</u> : <u>L-50%</u>) [3:3]** • 7.5 Hz (<u>U-50%</u> : <u>L-50%</u>) [4:4]** • 5 Hz (<u>U-50%</u> : <u>L-50%</u>) [6:6]** • 2.5 Hz (<u>U-50%</u> : <u>L-50%</u>) [12:12]** • 1.5 Hz (<u>U-50%</u> : <u>L-50%</u>) [20:20]** ** number of frames during which AO occupies upper and lower part of the screen
	SHIFT + LEFT + RIGHT set default gap	Default alternately occluding object gap is <u>0</u>
	SHIFT + UP + DOWN set default on/off state of AO and its break	Default state is <u>ON</u> Default break is <u>0</u>
UP + DOWN + LEFT + RIGHT restore default values for all settings from PAGE 0	<ul style="list-style-type: none"> • frequency: <u>7.5Hz</u> • occlusion rate: <u>U-50% : L-50%</u> • state: <u>ON</u> • break: <u>0</u> • gap: <u>0</u> 	



PAGE	BUTTONS	DESCRIPTION
<p>PAGE 0 (continued)</p> <p> (both PAGE LEDs are turned off)</p> <p>This PAGE contains general settings of Alternately Occluding Object</p>	<p>SHIFT + UP + DOWN + LEFT + RIGHT</p> <p>restore default values for all settings from MODE 2</p>	<p>Alternately Occluding Object:</p> <ul style="list-style-type: none"> • frequency: <u>7.5Hz</u> • occlusion rate: <u>U-50% : L-50%</u> • state: <u>ON</u> • break: <u>0</u> • gap: <u>0</u> • default position and size • offset: <u>0</u> <p>Dichoptic Object:</p> <ul style="list-style-type: none"> • period: <u>2s</u> • occlusion rate: <u>U-50% : L-50%</u> • state: <u>ON</u> • break: <u>0</u> • offset: <u>0</u> • default position and size
<p>PAGE 1</p> <p> (right PAGE LED is turned on)</p> <p>This PAGE contains position settings of Alternately Occluding Object</p>	Position of Alternately Occluding Object	
	UP	position object higher up on screen
	SHIFT + UP	position object higher up on screen at increased speed
	DOWN	Position object lower down on screen
	SHIFT + DOWN	Position object lower down on screen at increased speed
	LEFT	Position object more to the left
	SHIFT + LEFT	Position object more to the left at increased speed
	RIGHT	Position object more to the right
	SHIFT + RIGHT	Position object more to the right at increased speed
	Alternately Occluding Object Offset in SBS mode can be achieved by changing Alternately Occluding Object Gap	
	Restoring default settings	
	UP + DOWN SHIFT + UP + DOWN	Restore default vertical position of a object
LEFT + RIGHT SHIFT + LEFT + RIGHT	Restore default horizontal position of a object	
UP + LEFT + RIGHT	Restore AO offset to the default value of <u>0</u>	

PAGE	BUTTONS	DESCRIPTION
<p>PAGE 1 (continued)</p>  <p>(right PAGE LED is turned on)</p> <p>This PAGE contains position settings of Alternately Occluding Object</p>	<p>UP + DOWN + LEFT + RIGHT restore default values for all settings from PAGE 1</p>	<p>Restore both vertical and horizontal position of a object, also the offset</p>
	<p>SHIFT + UP + DOWN + LEFT + RIGHT restore default values for all settings from MODE 2</p>	<p>Alternately Occluding Object:</p> <ul style="list-style-type: none"> • frequency: <u>7.5Hz</u> • occlusion rate: <u>U-50% : L-50%</u> • state: <u>ON</u> • break: <u>0</u> • gap: <u>0</u> • default position and size • offset: <u>0</u> <p>Dichoptic Object:</p> <ul style="list-style-type: none"> • period: <u>2s</u> • occlusion rate: <u>U-50% : L-50%</u> • state: <u>ON</u> • break: <u>0</u> • offset: <u>0</u> • default position and size
<p>PAGE 2</p>  <p>(left PAGE LED is turned on)</p> <p>This PAGE contains size settings of Alternately Occluding Object</p>	Size of Alternately Occluding Object	
	UP	Decrease vertical size of a object
	SHIFT + UP	Decrease vertical size of a object at increased speed
	DOWN	Increase vertical size of a object
	SHIFT + DOWN	Increase vertical size of a object at increased speed
	LEFT	Decrease horizontal size of a object
	SHIFT + LEFT	Decrease horizontal size of a object at increased speed
	RIGHT	Increase horizontal size of a object
	SHIFT + RIGHT	Increase horizontal size of a object at increased speed
	Restoring default settings	
	UP + DOWN SHIFT + UP + DOWN	Restore default vertical size of a object
	LEFT + RIGHT SHIFT + LEFT + RIGHT	Restore default horizontal size of a object

PAGE	BUTTONS	DESCRIPTION
<p style="text-align: center;">PAGE 2 (continued)</p> <div style="text-align: center;">  <p>(left PAGE LED is turned on)</p> </div> <p>This PAGE contains size settings of Alternately Occluding Object</p>	<p style="text-align: center;">UP + DOWN + LEFT + RIGHT restore default values for all settings from PAGE 2</p>	<p style="text-align: center;">Restore both vertical and horizontal size of a object</p>
	<p style="text-align: center;">SHIFT + UP + DOWN + LEFT + RIGHT restore default values for all settings from MODE 2</p>	<p>Alternately Occluding Object:</p> <ul style="list-style-type: none"> • frequency: <u>7.5Hz</u> • occlusion rate: <u>U-50% : L-50%</u> • state: <u>ON</u> • break: <u>0</u> • gap: <u>0</u> • default position and size • offset: <u>0</u> <p>Dichoptic Object:</p> <ul style="list-style-type: none"> • period: <u>2s</u> • occlusion rate: <u>U-50% : L-50%</u> • state: <u>ON</u> • break: <u>0</u> • offset: <u>0</u> • default position and size

PAGE	BUTTONS	DESCRIPTION
<p style="text-align: center;">PAGE 3</p> <div style="text-align: center;">  <p>(both PAGE LEDs are turned on)</p> </div> <p style="text-align: center;">This PAGE contains general settings of Dichoptic Object</p>	<p>UP decrease period</p> <hr/> <p>DOWN increase period</p>	<p style="text-align: center;">Dichoptic Object Period</p> <p style="text-align: center;">Available periods are:</p> <ul style="list-style-type: none"> • 0.4s (U-50% : L-50%)* [24]** • 0.67s (U-50% : L-50%)* [40]** • 1.33s (U-50% : L-50%)* [80]** • <u>2s</u> (U-50% : L-50%)* [120]** • 3.33s (U-50% : L-50%)* [200]** • 4.67s (U-50% : L-50%)* [280]** • 8s (U-50% : L-50%)* [480]** <p style="text-align: right;">* default occlusion rate is set during change of period ** number of frames during which alternation cycle is concluded</p>
	<p>LEFT less occlusion of upper part</p> <hr/> <p>RIGHT more occlusion of upper part</p>	<p style="text-align: center;">Dichoptic Object Occlusion Rate (occlusions per Upper and Lower part of the screen)</p> <p style="text-align: center;">Available occlusion rates depend on current period:</p> <ul style="list-style-type: none"> • 0.4s <ul style="list-style-type: none"> ◦ U-0% : L-100% [0:24]** ◦ U-25% : L-75% [6:18]** ◦ <u>U-50% : L-50% [12:12]**</u> ◦ U-75% : L-25% [18:6]** ◦ U-100% : L-0% [24:0]** • 0.67s <ul style="list-style-type: none"> ◦ U-0% : L-100% [0:40]** ◦ U-25% : L-75% [10:30]** ◦ <u>U-50% : L-50% [20:20]**</u> ◦ U-75% : L-25% [30:10]** ◦ U-100% : L-0% [40:0]** • 1.33s <ul style="list-style-type: none"> ◦ U-0% : L-100% [0:80]** ◦ U-25% : L-75% [20:60]** ◦ <u>U-50% : L-50% [40:40]**</u> ◦ U-75% : L-25% [60:20]** ◦ U-100% : L-0% [80:0]** • 2s <ul style="list-style-type: none"> ◦ U-0% : L-100% [0:120]** ◦ U-16.7% : L-83.3% [20:100]** ◦ U-33.3% : L-66.7% [40:80]** ◦ <u>U-50% : L-50% [60:60]**</u> ◦ U-66.7% : L-33.3% [80:40]** ◦ U-83.3% : L-16.7% [100:20]** ◦ U-100% : L-0% [120:0]** • 3.33s <ul style="list-style-type: none"> ◦ U-0% : L-100% [0:200]** ◦ U-10% : L-90% [20:180]** ◦ U-20% : L-80% [40:160]** ◦ U-30% : L-70% [60:140]** ◦ U-40% : L-60% [80:120]** ◦ <u>U-50% : L-50% [100:100]**</u> ◦ U-60% : L-40% [120:80]** ◦ U-70% : L-30% [140:60]** ◦ U-80% : L-20% [160:40]** ◦ U-90% : L-10% [180:20]** ◦ U-100% : L-0% [200:0]** • 4.67s <ul style="list-style-type: none"> ◦ U-0% : L-100% [0:280]** ◦ U-7.1% : L-92.9% [20:260]** ◦ U-14.3% : L-85.7% [40:240]** ◦ U-21.4% : L-78.6% [60:220]** ◦ U-28.6% : L-71.4% [80:200]** ◦ U-35.7% : L-64.3% [100:180]** ◦ U-42.9% : L-57.1% [120:160]** ◦ <u>U-50% : L-50% [140:140]**</u> ◦ U-57.1% : L-42.9% [160:120]** ◦ U-64.3% : L-35.7% [180:100]** ◦ U-71.4% : L-28.6% [200:80]** ◦ U-78.6% : L-21.4% [220:60]** ◦ U-85.7% : L-14.3% [240:40]** ◦ U-92.9% : L-7.1% [260:20]** ◦ U-100% : L-0% [280:0]** • 4.67s <ul style="list-style-type: none"> ◦ U-0% : L-100% [0:480]** ◦ U-8.3% : L-91.7% [40:440]** ◦ U-16.7% : L-83.3% [80:400]** ◦ U-25% : L-75% [120:360]** ◦ U-33.3% : L-66.7% [160:320]** ◦ U-41.7% : L-58.3% [200:280]** ◦ <u>U-50% : L-50% [240:240]**</u> ◦ U-58.3% : L-41.7% [280:200]** ◦ U-66.7% : L-33.3% [320:160]** ◦ U-75% : L-25% [360:120]** ◦ U-83.3% : L-16.7% [400:80]** ◦ U-91.7% : L-8.3% [440:40]** ◦ U-100% : L-0% [480:0]** <p style="text-align: right;">** number of frames during which DI occupies upper and lower part of the screen</p>
	<p>Dichoptic Object ON/OFF</p>	<p>SHIFT + UP toggle <u>on</u> /off state of the object</p> <p>Dichoptic Object can be completely turned off and not being visible on screen.</p>

PAGE	BUTTONS	DESCRIPTION
<p style="text-align: center;">PAGE 3 (continued)</p> <p style="text-align: center;">● ●</p> <p>(both PAGE LEDs are turned on)</p> <p>This PAGE contains general settings of Dichoptic Object</p>	Dichoptic Object Offset	
	SHIFT + LEFT lower object more to the left	When offset is $\underline{0}$, object's upper position is directly above the lower one. When offset is different than $\underline{0}$, lower object is positioned more to the left or right compared to its default position. This should make object appear in front or behind the screen when viewed stereoscopically.
	SHIFT + RIGHT lower object more to the right	
	Dichoptic Object Break	
	SHIFT + DOWN increase DI break	Break is time between DI object appearance on upper and lower parts of the screen when DI is not visible. When break exceeds its maximum value, set it to $\underline{0}$. Increasing break increase total duration of alternation cycle. Break is incremented differently when different periods are used: <ul style="list-style-type: none"> • 0.4s – increment: 0.2s [12]**; maximum 0.8s [48]** • 0.67s – increment: 0.33s [20]**; maximum 1.33s [80]** • 1.33s – increment: 0.33s [20]**; maximum 1.33s [80]** • 2s – increment: 0.33s [20]**; maximum 1.33s [80]** • 3.33s – increment: 0.33s [20]**; maximum 1.33s [80]** • 4.67s – increment: 0.33s [20]**; maximum 1.33s [80]** • 8s – increment: 0.67s [40]**; maximum 2.67s [160]** ** number of frames
	Restoring default settings	
	UP + DOWN set default frequency	Default dichoptic object period is $\underline{2s}$ (U-50% : L-50%)* *default occlusion rate is set during change of period
	LEFT + RIGHT set default occlusion rate	Default occlusion rates for different periods : <ul style="list-style-type: none"> • 0.4s (U-50% : L-50%) [12:12]** • 0.67s (U-50% : L-50%) [20:20]** • 1.33s (U-50% : L-50%) [40:40]** • 2s (U-50% : L-50%) [60:60]** • 3.33s (U-50% : L-50%) [100:100]** • 4.67 (U-50% : L-50%) [140:140]** • 8s (U-50% : L-50%) [240:240]** ** number of frames during which DI occupies upper and lower part of the screen
SHIFT + LEFT + RIGHT set default offset	Default dichoptic object offset is $\underline{0}$.	
SHIFT + UP + DOWN set default on/off state of DI and its break	Default state is \underline{ON} Default break is $\underline{0}$	

PAGE	BUTTONS	DESCRIPTION
<p>PAGE 3 (continued)</p>  <p>(both PAGE LEDs are turned on)</p> <p>This PAGE contains general settings of Dichoptic Object</p>	<p>UP + DOWN + LEFT + RIGHT restore default values for all settings from PAGE 3</p>	<ul style="list-style-type: none"> • period: <u>2s</u> • occlusion rate: <u>U-50% : L-50%</u> • state: <u>ON</u> • break: <u>0</u> • offset: <u>0</u>
	<p>SHIFT + UP + DOWN + LEFT + RIGHT restore default values for all settings from MODE 2</p>	<ul style="list-style-type: none"> • Alternately Occluding Object: • frequency: <u>7.5Hz</u> • occlusion rate: <u>U-50% : L-50%</u> • state: <u>ON</u> • break: <u>0</u> • gap: <u>0</u> • default position and size • offset: <u>0</u> • Dichoptic Object: • period: <u>2s</u> • occlusion rate: <u>U-50% : L-50%</u> • state: <u>ON</u> • break: <u>0</u> • offset: <u>0</u> • default position and size
<p>PAGE 4</p>  <p>(PAGE LEDs are flashing at low frequency)</p> <p>This PAGE contains position settings of Dichoptic Object</p>	Position of Dichoptic Object	
	UP	Position object higher up on screen
	SHIFT + UP	Position object higher up on screen at increased speed
	DOWN	Position object lower down on screen
	SHIFT + DOWN	Position object lower down on screen at increased speed
	LEFT	Position object more to the left
	SHIFT + LEFT	Position object more to the left at increased speed
	RIGHT	Position object more to the right
	SHIFT + RIGHT	Position object more to the right at increased speed
	Restoring default settings	
	UP + DOWN SHIFT + UP + DOWN	Restore default vertical size of a object
LEFT + RIGHT SHIFT + LEFT + RIGHT	Restore default horizontal size of a object	

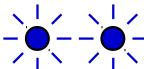
PAGE	BUTTONS	DESCRIPTION
<p>PAGE 4 (continued)</p>  <p>(PAGE LEDs are flashing at low frequency)</p> <p>This PAGE contains position settings of Dichoptic Object</p>	<p>UP + DOWN + LEFT + RIGHT restore default values for all settings from PAGE 4</p>	<p>Restore both vertical and horizontal size of a object</p>
	<p>SHIFT + UP + DOWN + LEFT + RIGHT restore default values for all settings from MODE 2</p>	<p>Alternately Occluding Object:</p> <ul style="list-style-type: none"> • frequency: <u>7.5Hz</u> • occlusion rate: <u>U-50% : L-50%</u> • state: <u>ON</u> • break: <u>0</u> • gap: <u>0</u> • default position and size • offset: <u>0</u> <p>Dichoptic Object:</p> <ul style="list-style-type: none"> • period: <u>2s</u> • occlusion rate: <u>U-50% : L-50%</u> • state: <u>ON</u> • break: <u>0</u> • offset: <u>0</u> • default position and size
<p>PAGE 5</p>  <p>(PAGE LEDs are flashing at high frequency)</p> <p>This PAGE contains size settings of Dichoptic Object</p>	<p>Size of Dichoptic Object</p>	
	<p>UP</p>	<p>Decrease vertical size of a object</p>
	<p>SHIFT + UP</p>	<p>Decrease vertical size of a object at increased speed</p>
	<p>DOWN</p>	<p>Increase vertical size of a object</p>
	<p>SHIFT + DOWN</p>	<p>Increase vertical size of a object at increased speed</p>
	<p>LEFT</p>	<p>Decrease horizontal size of a object</p>
	<p>SHIFT + LEFT</p>	<p>Decrease horizontal size of a object at increased speed</p>
	<p>RIGHT</p>	<p>Increase horizontal size of a object</p>
	<p>SHIFT + RIGHT</p>	<p>Increase horizontal size of a object at increased speed</p>
	<p>Restoring default settings</p>	
	<p>UP + DOWN SHIFT + UP + DOWN</p>	<p>Restore default vertical size of a object</p>
<p>LEFT + RIGHT SHIFT + LEFT + RIGHT</p>	<p>Restore default horizontal size of a object</p>	

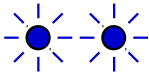
PAGE	BUTTONS	DESCRIPTION
<p>PAGE 5 (continued)</p>  <p>(PAGE LEDs are flashing at high frequency)</p> <p>This PAGE contains size settings of Dichoptic Object</p>	<p>UP + DOWN + LEFT + RIGHT restore default values for all settings from PAGE 5</p>	<p>Restore both vertical and horizontal size of a object</p>
	<p>SHIFT + UP + DOWN + LEFT + RIGHT restore default values for all settings from MODE 2</p>	<p>Alternately Occluding Object:</p> <ul style="list-style-type: none"> • frequency: <u>7.5Hz</u> • occlusion rate: <u>U-50% : L-50%</u> • state: <u>ON</u> • break: <u>0</u> • gap: <u>0</u> • default position and size • offset: <u>0</u> <p>Dichoptic Object:</p> <ul style="list-style-type: none"> • period: <u>2s</u> • occlusion rate: <u>U-50% : L-50%</u> • state: <u>ON</u> • break: <u>0</u> • offset: <u>0</u> • default position and size

Numbers that are in italics and are underlined are the default values

MODE 3: NOT FINISHED YET

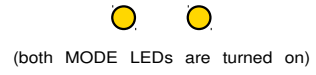
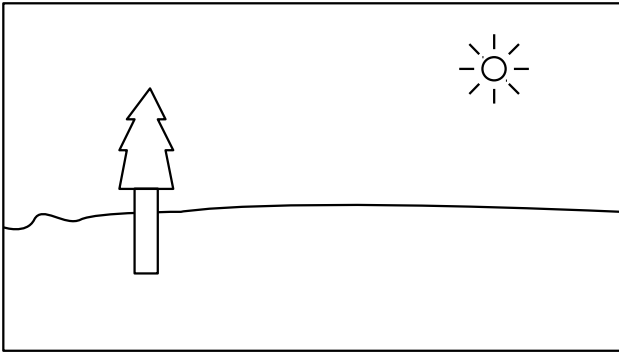

It behaves similarly to MODE 0: VIDEO PASS-THROUGH, except there are some object permanently displayed in the same place.