

(c) Koji Okada

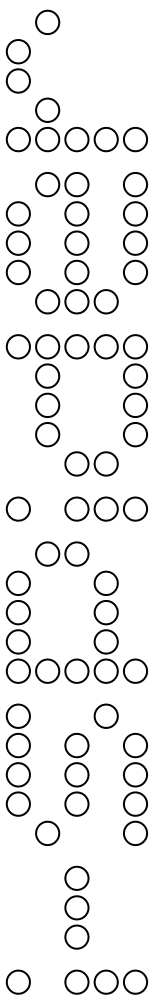

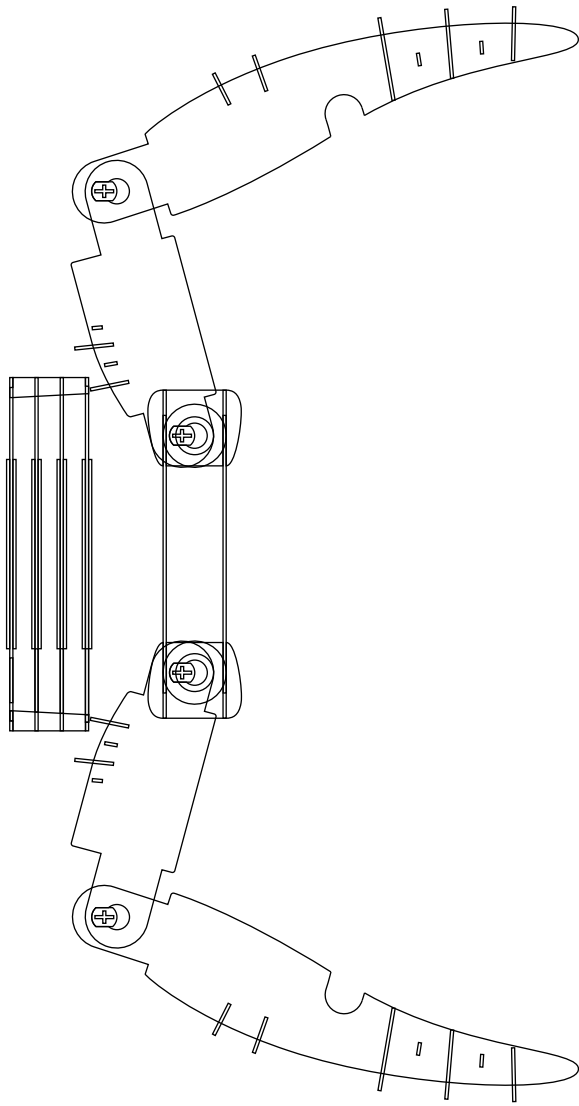

spider

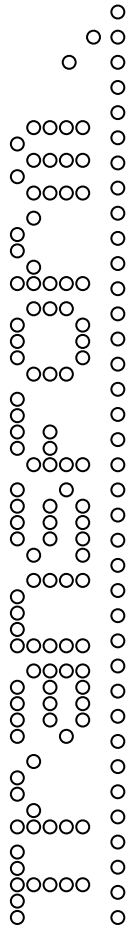
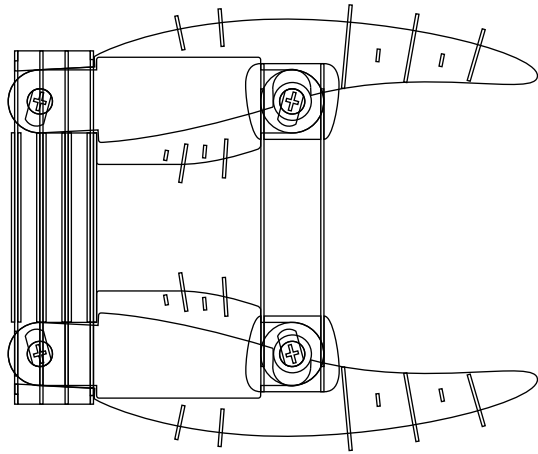

stool

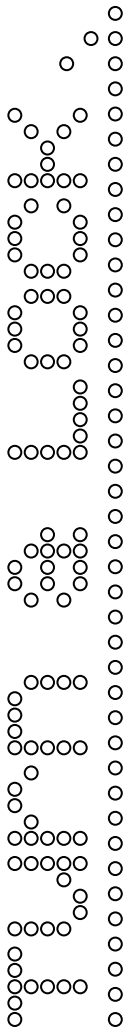
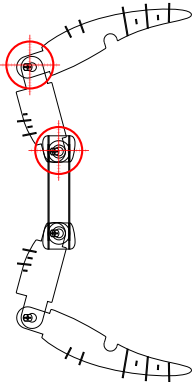

lock

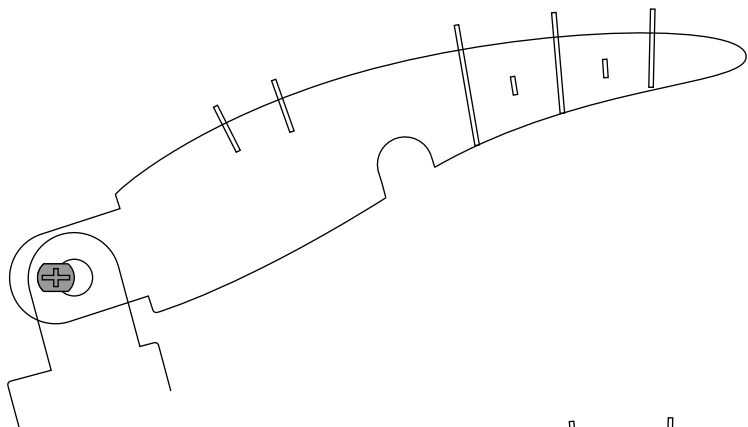

turn

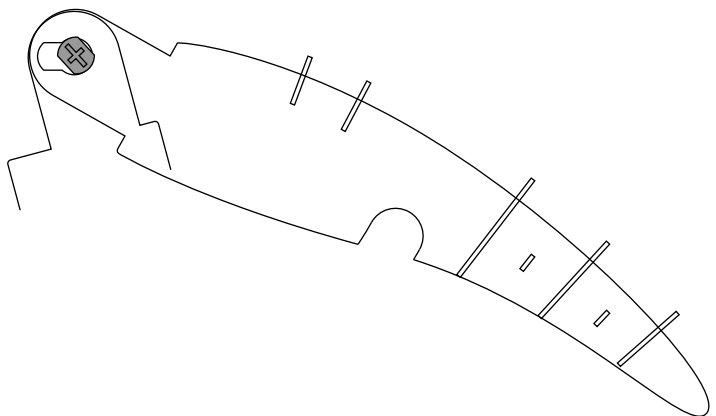
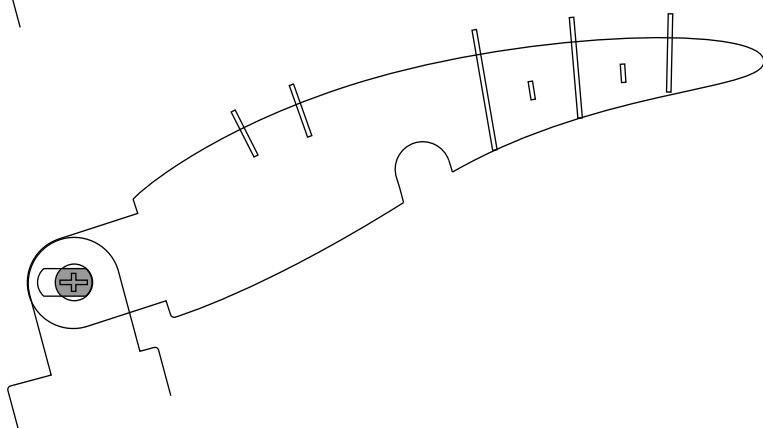

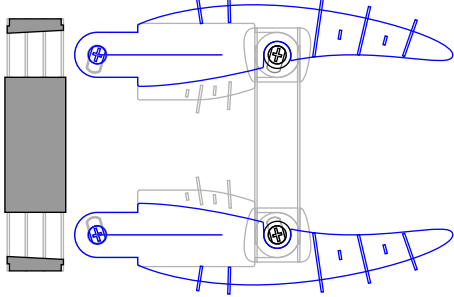
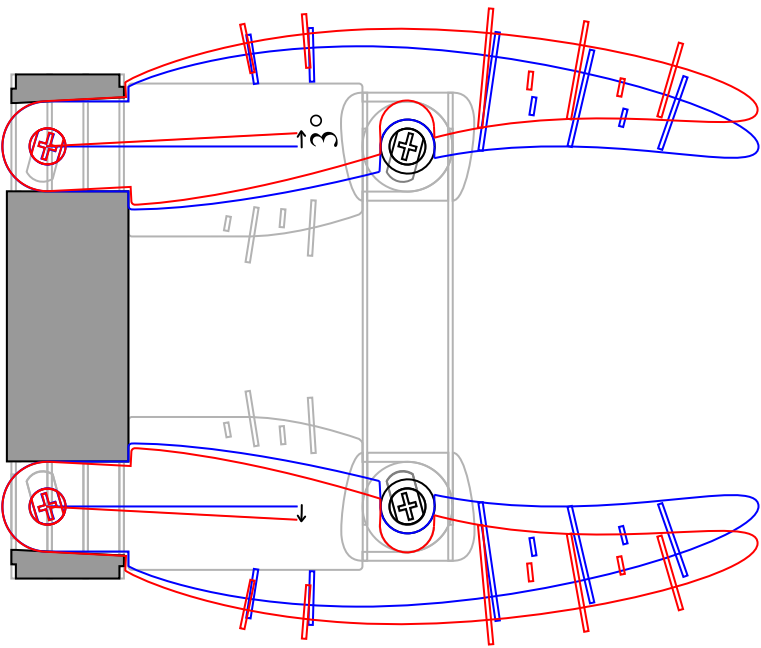
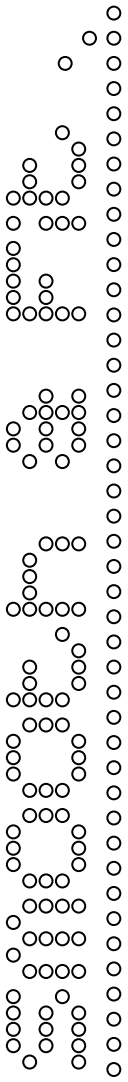

smooth

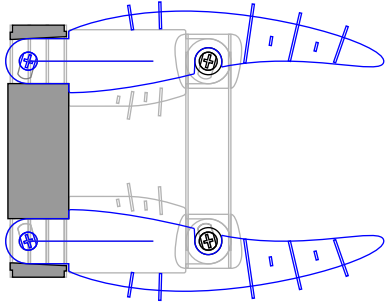

fit

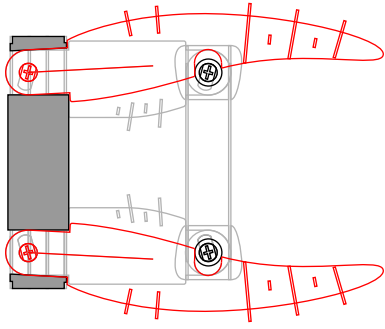

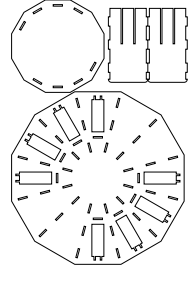
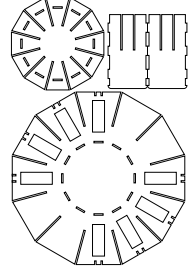
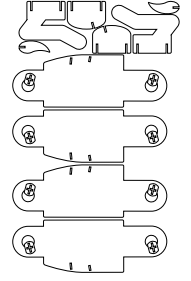
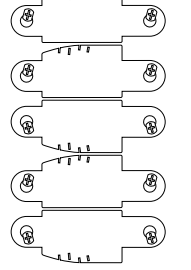
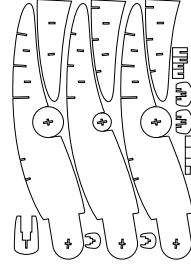
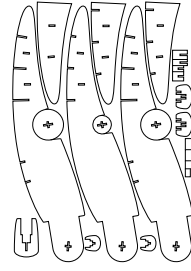
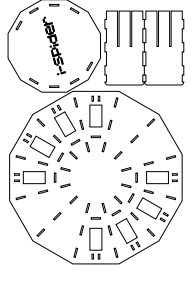
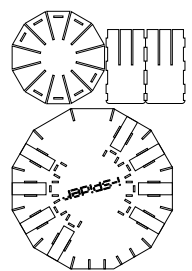
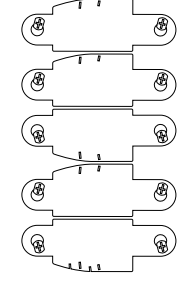
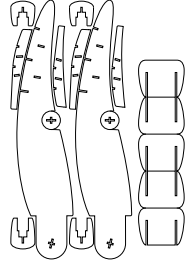
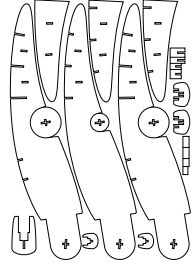
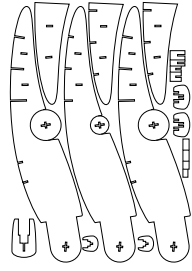
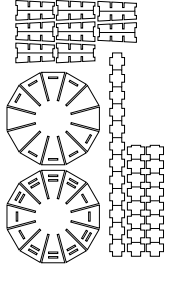
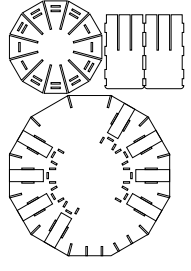
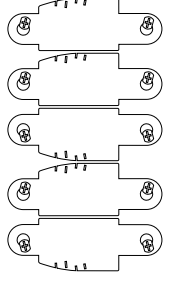
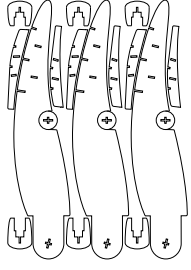
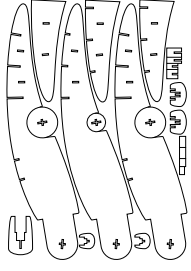
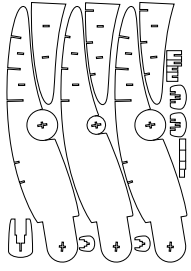
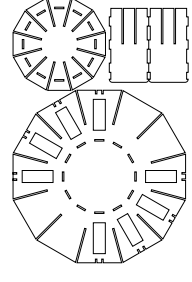
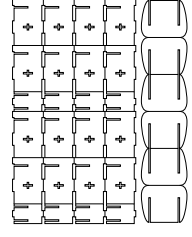
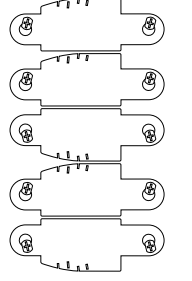
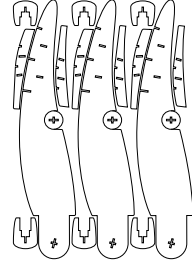
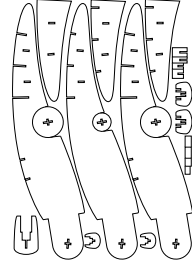
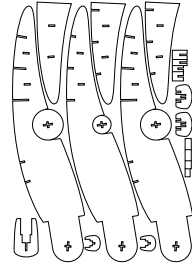
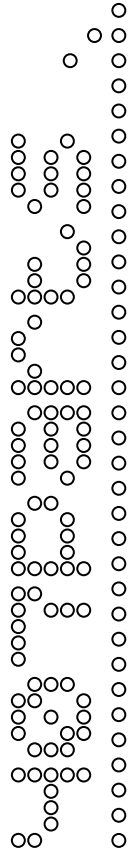

2.5mm MDF 1820×910×2

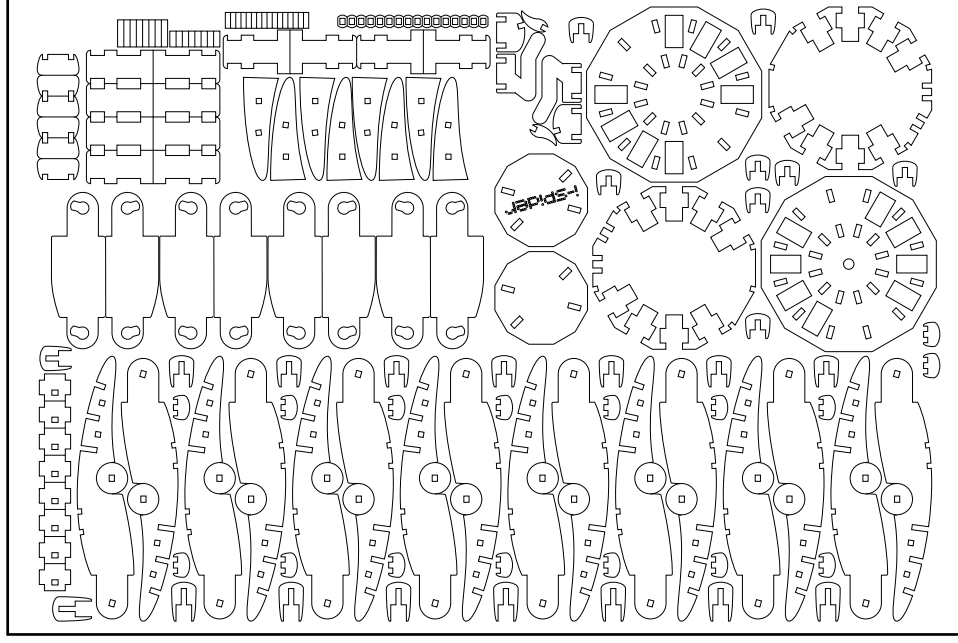
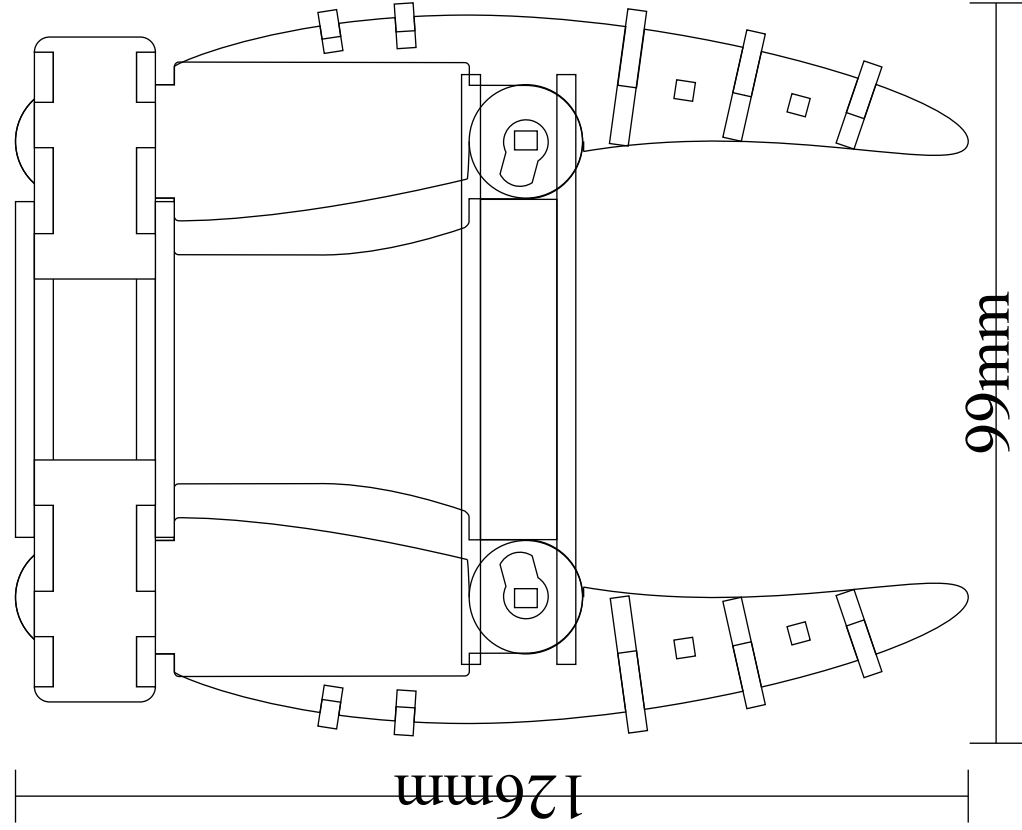
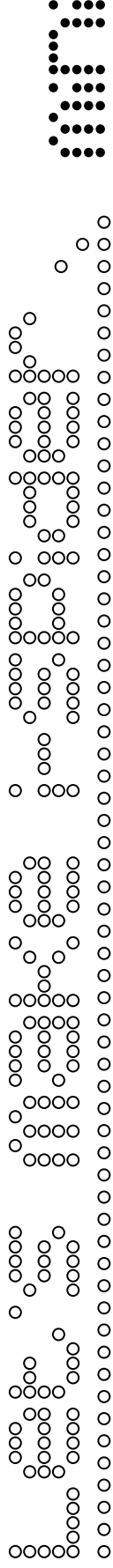

2.5mm MDF 450x300

