



DIGITAL DESIGNER 4.2

Model Name:
wind_speed

Number of Bricks: 32



Step 1 of 15

1 x



1 x



1 x



1 x



Step 2 of 15

1 x



3 x



Step 3 of 15

1 x



1 x



1 x



1 x

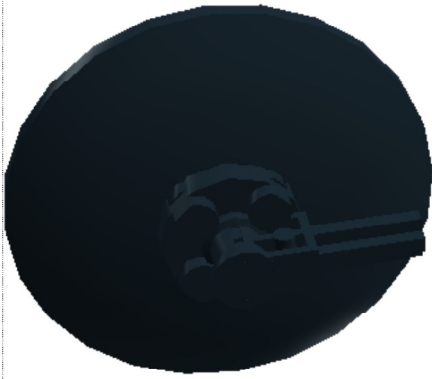

Step 5 of 15

1 x



1 x



1 x



1 x

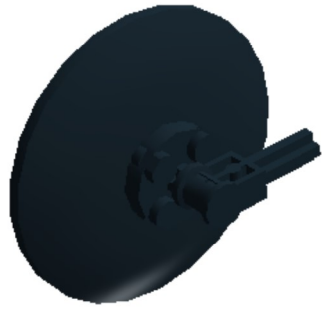

Step 6 of 15



Step 7 of 15

1 x



1 x



1 x



1 x



Step 8 of 15



Step 9 of 15

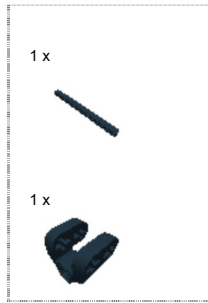

Step 10 of 15



Step 11 of 15

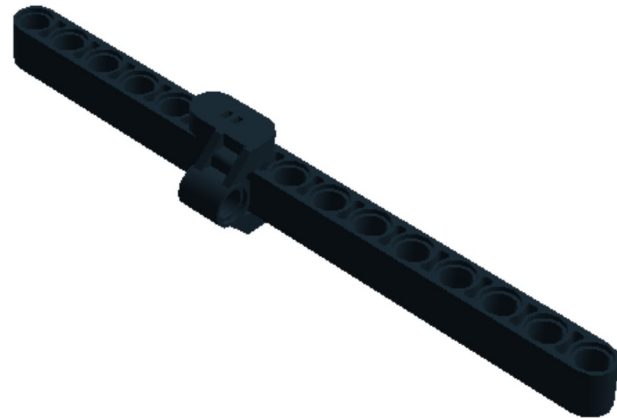

Step 12 of 15

2 x



1 x



Step 13 of 15

1 x



1 x





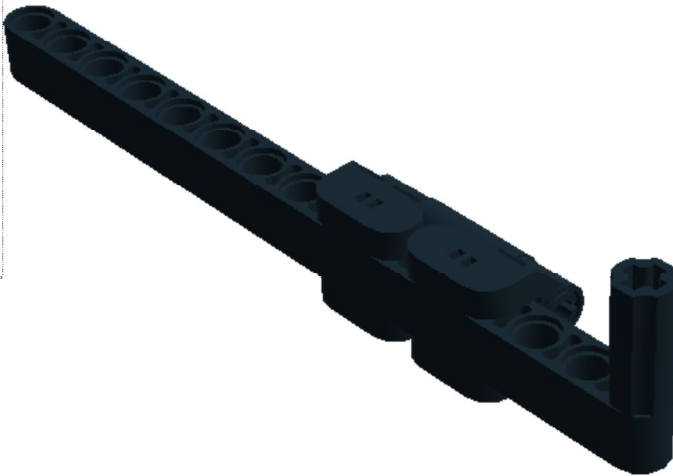
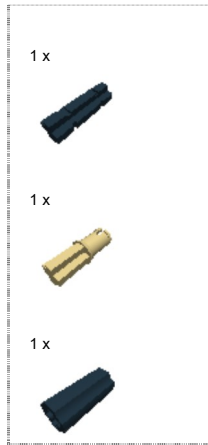











Step 14 of 15



Step 15 of 15



- | | | | | | | | | |
|-----|---|--|-----|---|---|-----|---|--|
| 3 x |  | 403226 PLATE 2X2 ROUND -
??Material26?? | 3 x |  | 4207127 PARABOLA 6X6 -
??Material26?? | 1 x |  | 4128603 TECHNIC 15M BEAM -
??Material26?? |
| 2 x |  | 4270046 1/2 BUSH - ??Material26?? | 7 x |  | 4109810 2M CROSS AXLE W.
GROOVE - ??Material26?? | 2 x |  | 278026 CONNECTOR PEG W.
FRICTION - ??Material26?? |
| 1 x |  | 4186017 CONNECTOR PEG/CROSS
AXLE - ??Material5?? | 1 x |  | 4177421 BUSH FOR CROSS AXLE -
??Material26?? | 1 x |  | 370526 CROSS AXLE 4M -
??Material26?? |
| 4 x |  | 4512363 CROSS AXLE,
EXTENSION, 2M -
??Material26?? | 1 x |  | 75619 TUBE Ø7,84 2M -
??Material26?? | 3 x |  | 4107765 CATCH - ??Material26?? |
| 1 x |  | 4502595 3-BRANCH CROSS AXLE
W/CROSS H. -
??Material194?? | 2 x |  | 4610371 CROSS BLOCK/Form
2X2X2 - ??Material26?? | | | |

© 2012 The LEGO Group. All rights reserved.
Use of the LEGO Digital Designer html print tool, signifies your agreement to the terms of use.