

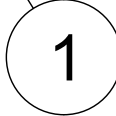

PARTS LIST			
ITEM	QTY	PART NUMBER	MATERIAL
1	2	COMPONENT22	STEEL
2	2	COMPONENT23	STEEL

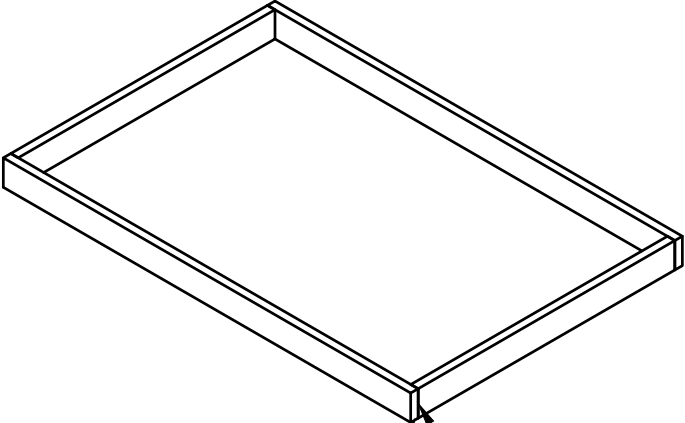

	PROJECT		
	Home		
	TITLE		
	Mice Cage		
APPROVED	SIZE	CODE	DWG NO
CHECKED	A		REV
DRAWN Asher Chung 1/1/2025	SCALE 1:8	WEIGHT	SHEET 1/4



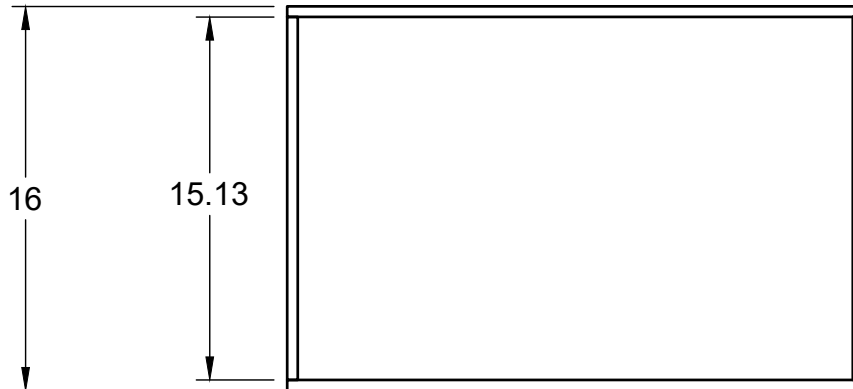
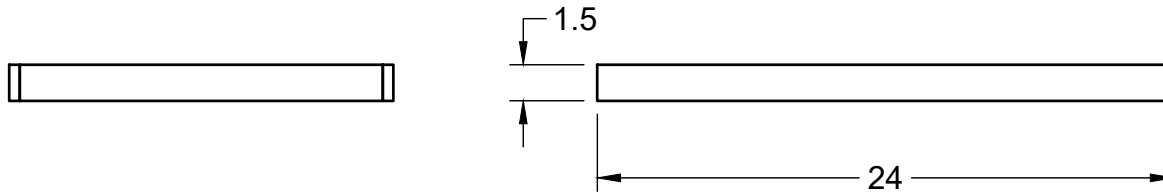

	PROJECT			
	Home			
	TITLE			
	Top plywood edges			
APPROVED	SIZE	CODE	DWG NO	REV
CHECKED	A			
DRAWN	Asher Chung	1/1/2025	SCALE 1:8	WEIGHT
				SHEET 2/4

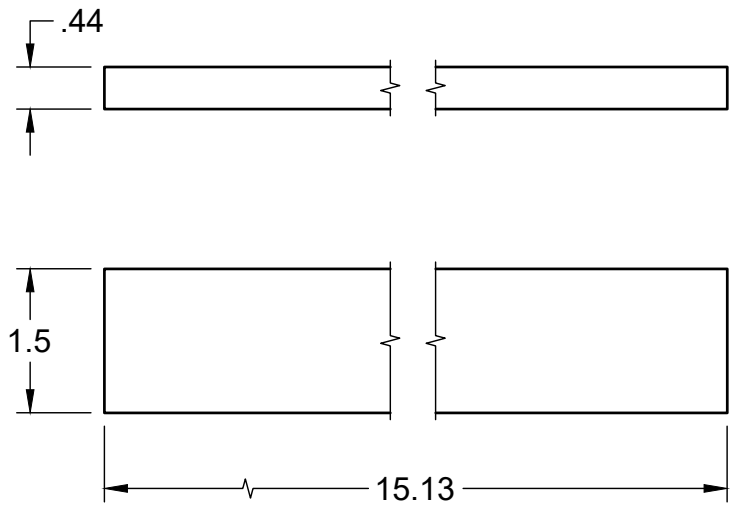

	PROJECT			
	Home			
	TITLE			
	Mice Cage			
APPROVED	SIZE	CODE	DWG NO	REV
CHECKED	A			
DRAWN	Asher Chung	1/1/2025	SCALE 1:2	WEIGHT
				SHEET 3/4

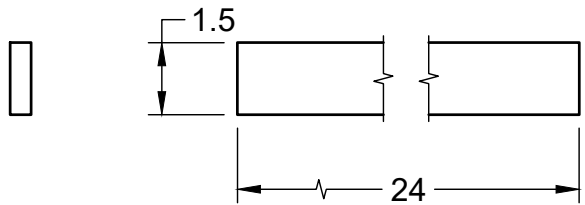
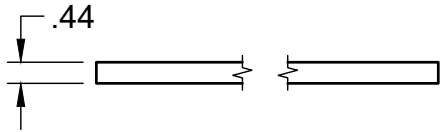

	PROJECT		
	Home		
	TITLE		
	Mice Cage		
APPROVED	SIZE	CODE	DWG NO
CHECKED	A		
DRAWN	Asher Chung	1/1/2025	SCALE 1:4
		WEIGHT	SHEET 4/4

