

Plastic Vise Assembly

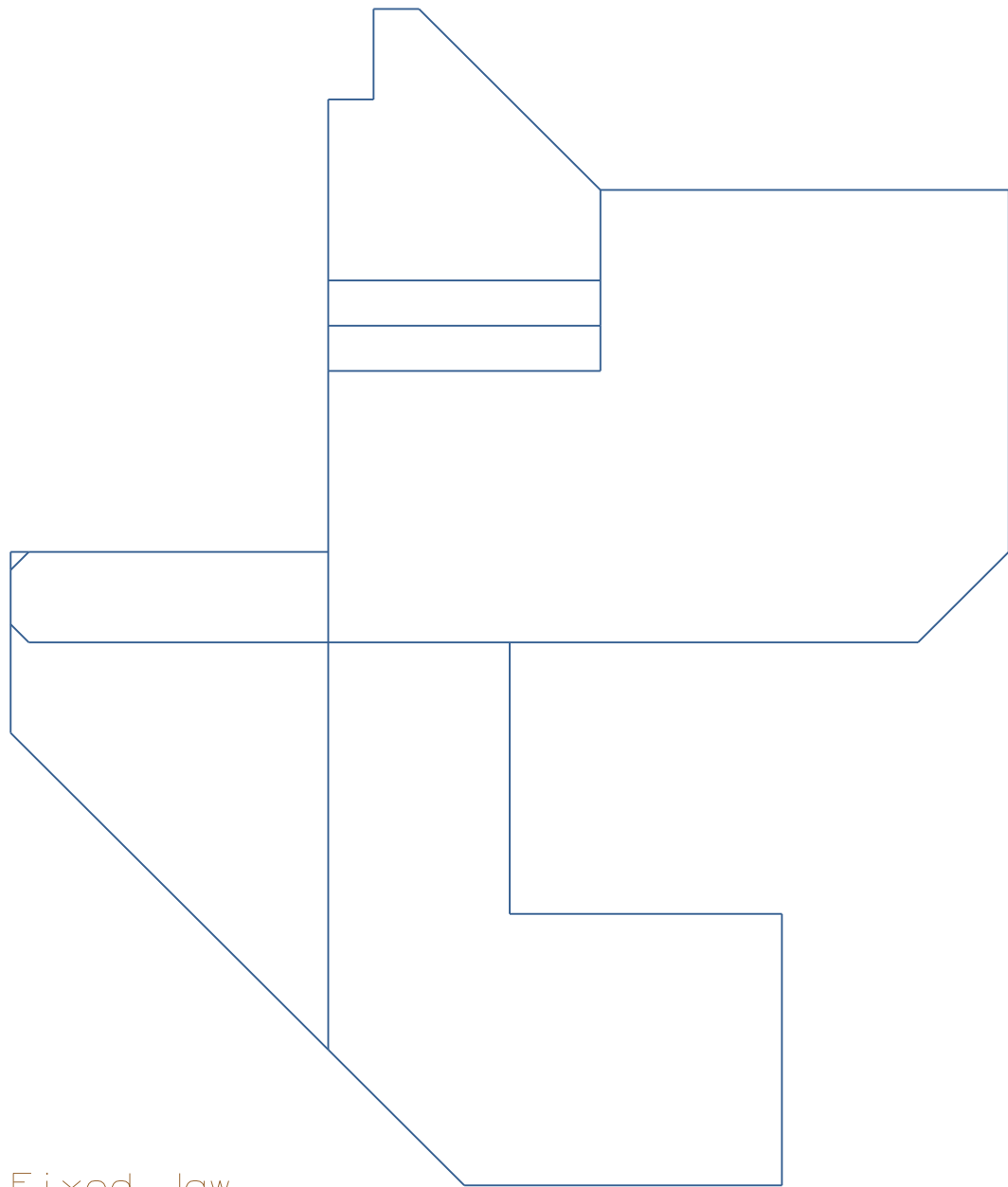

Fixed Jaw

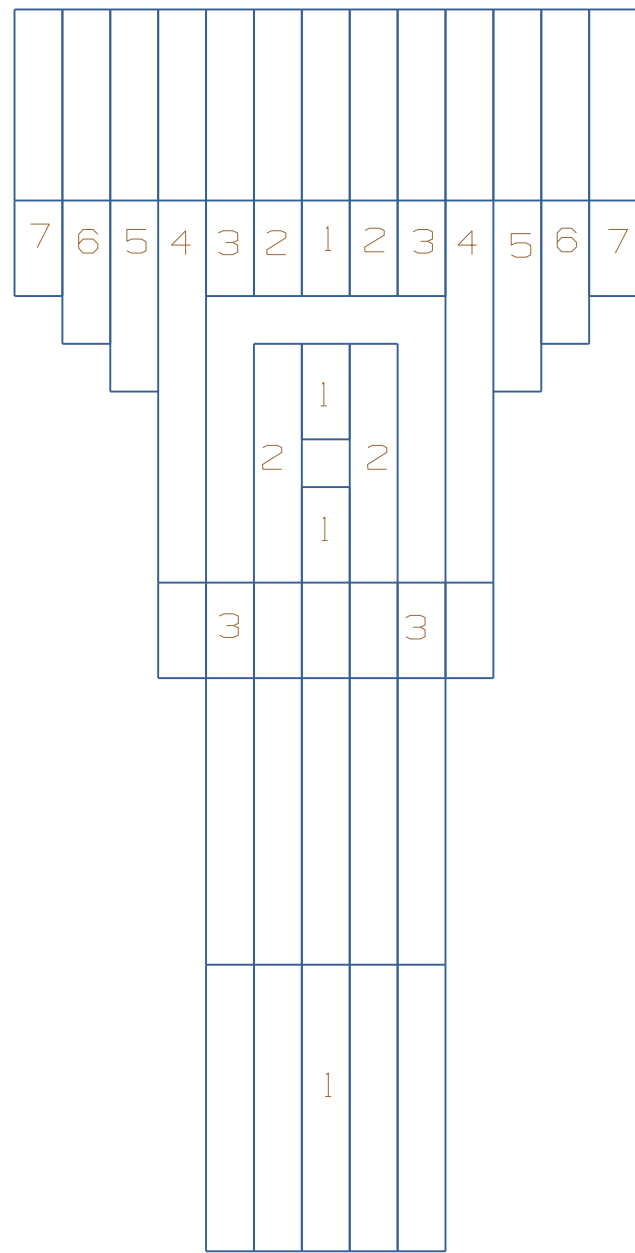



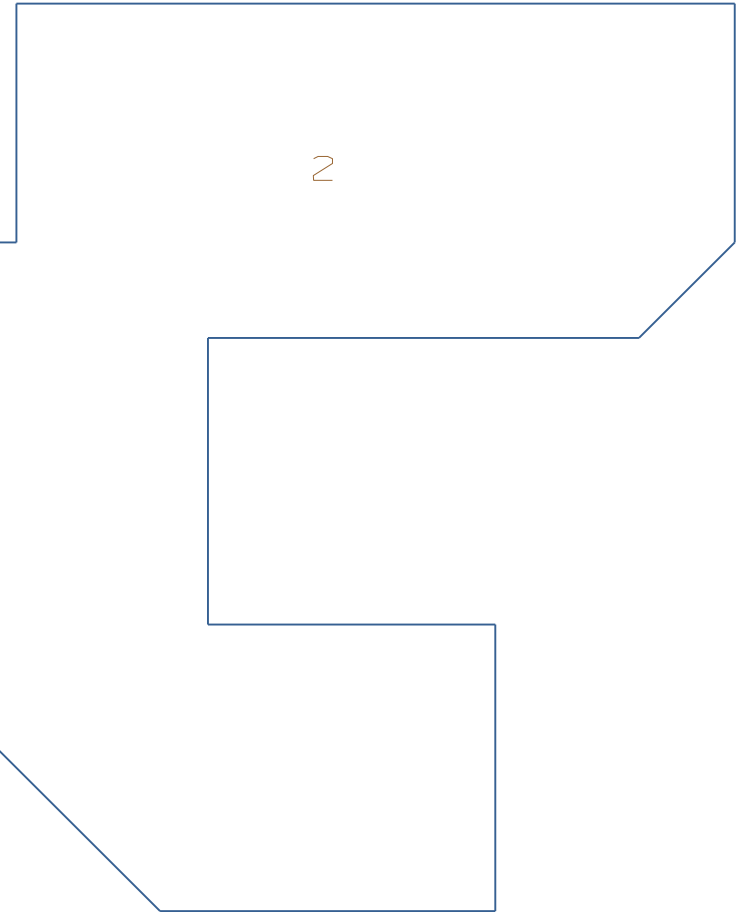
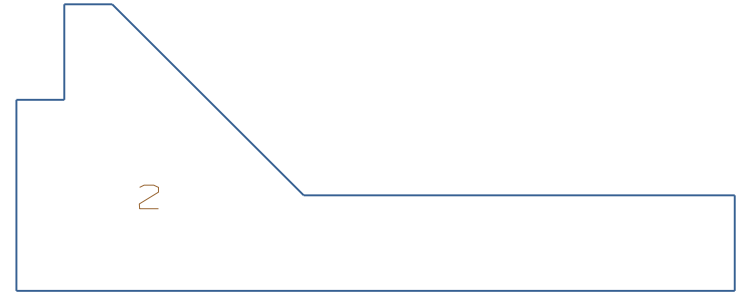
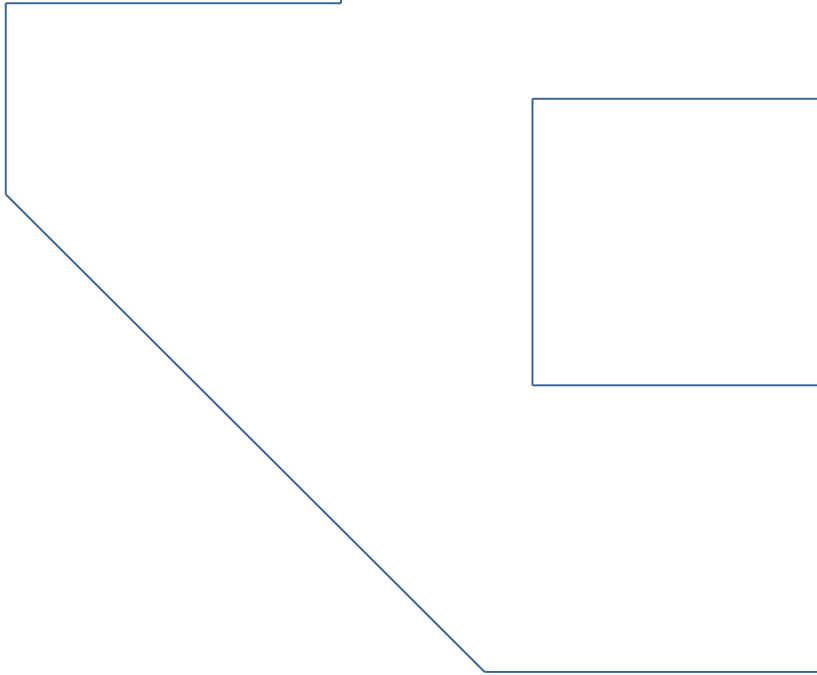
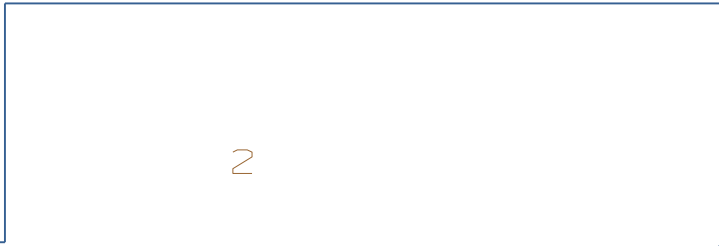
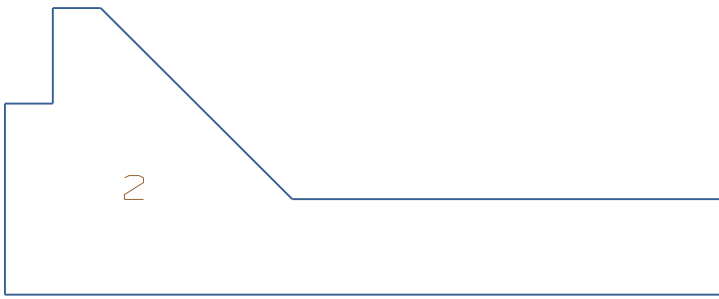

Fixed Jaw



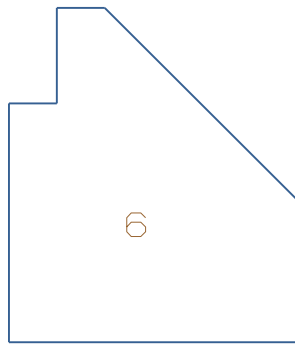
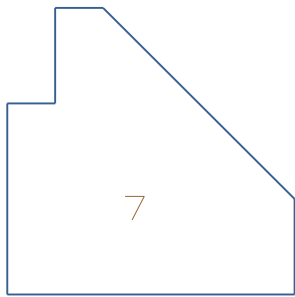
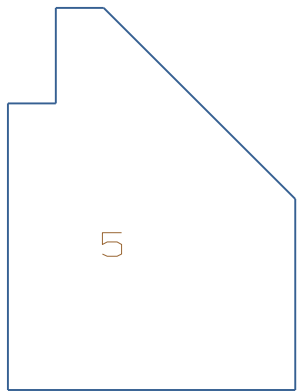
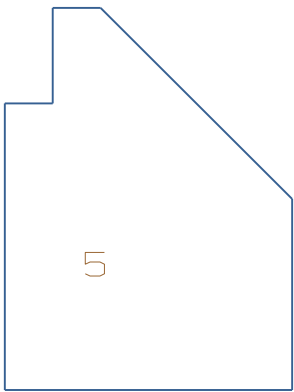
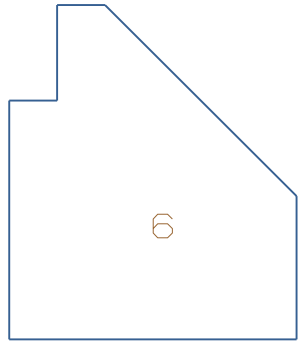
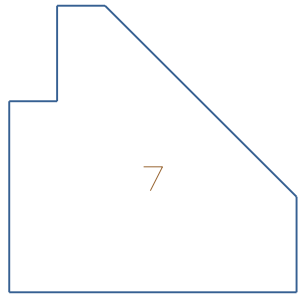
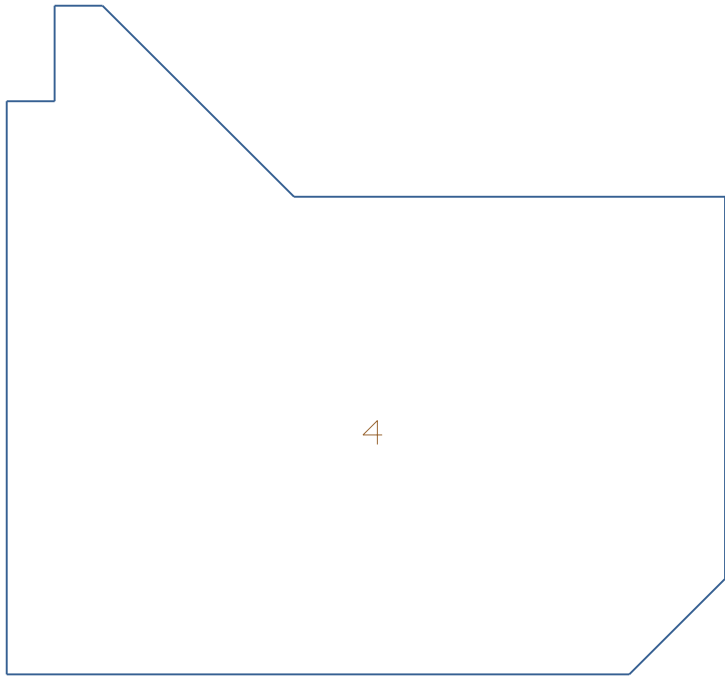
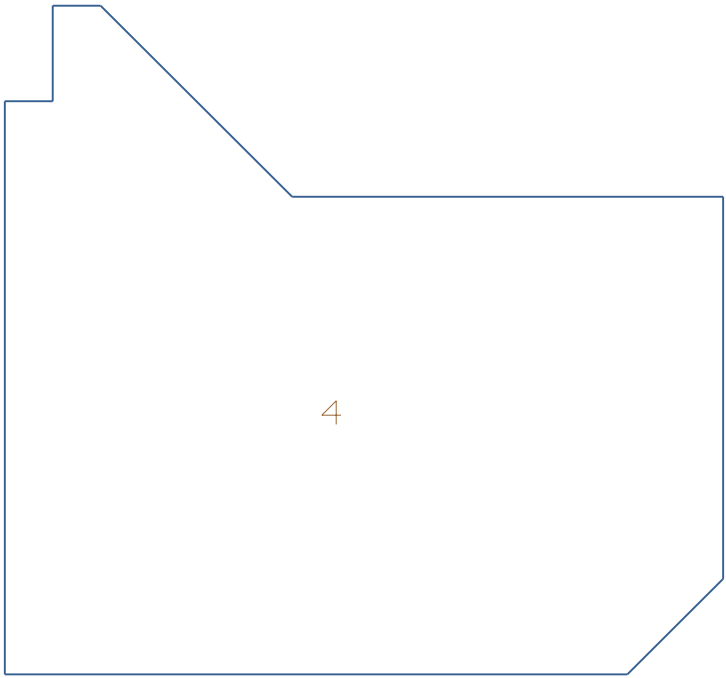

Replacement Jaw

Replacement Jaw

Fixed Jaw

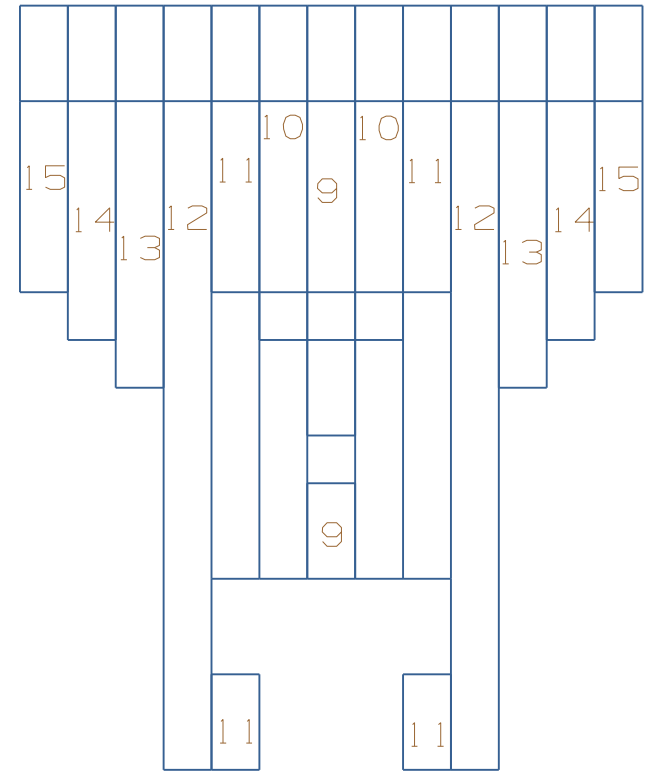
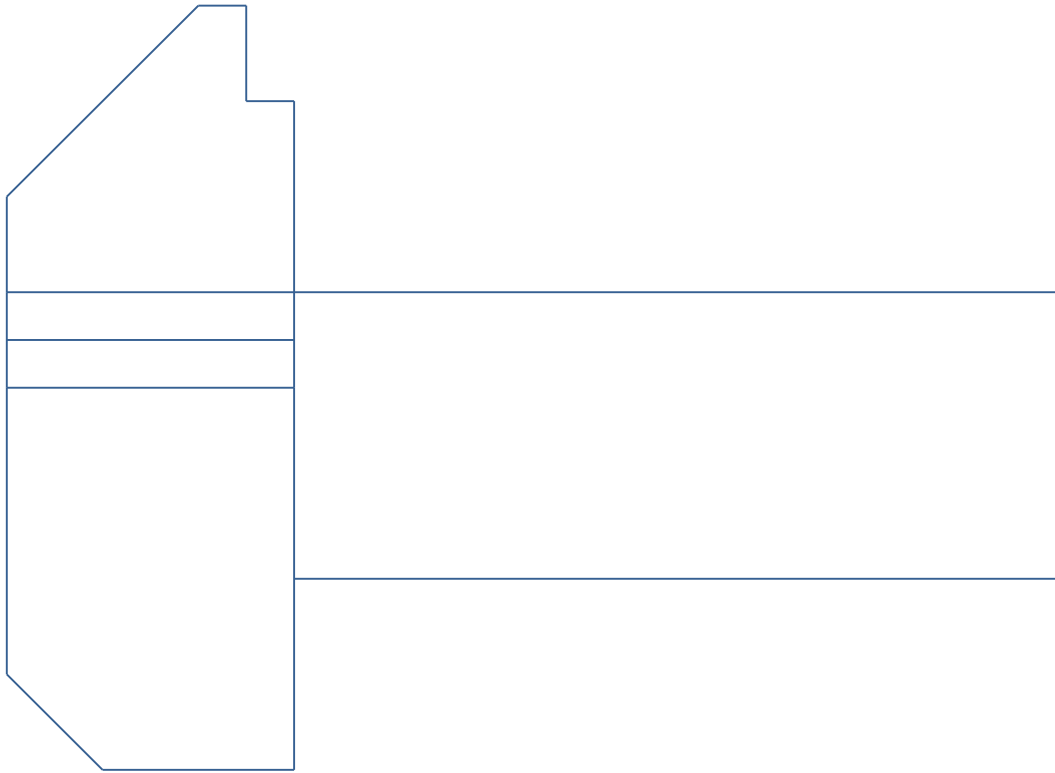

Moving Jaw



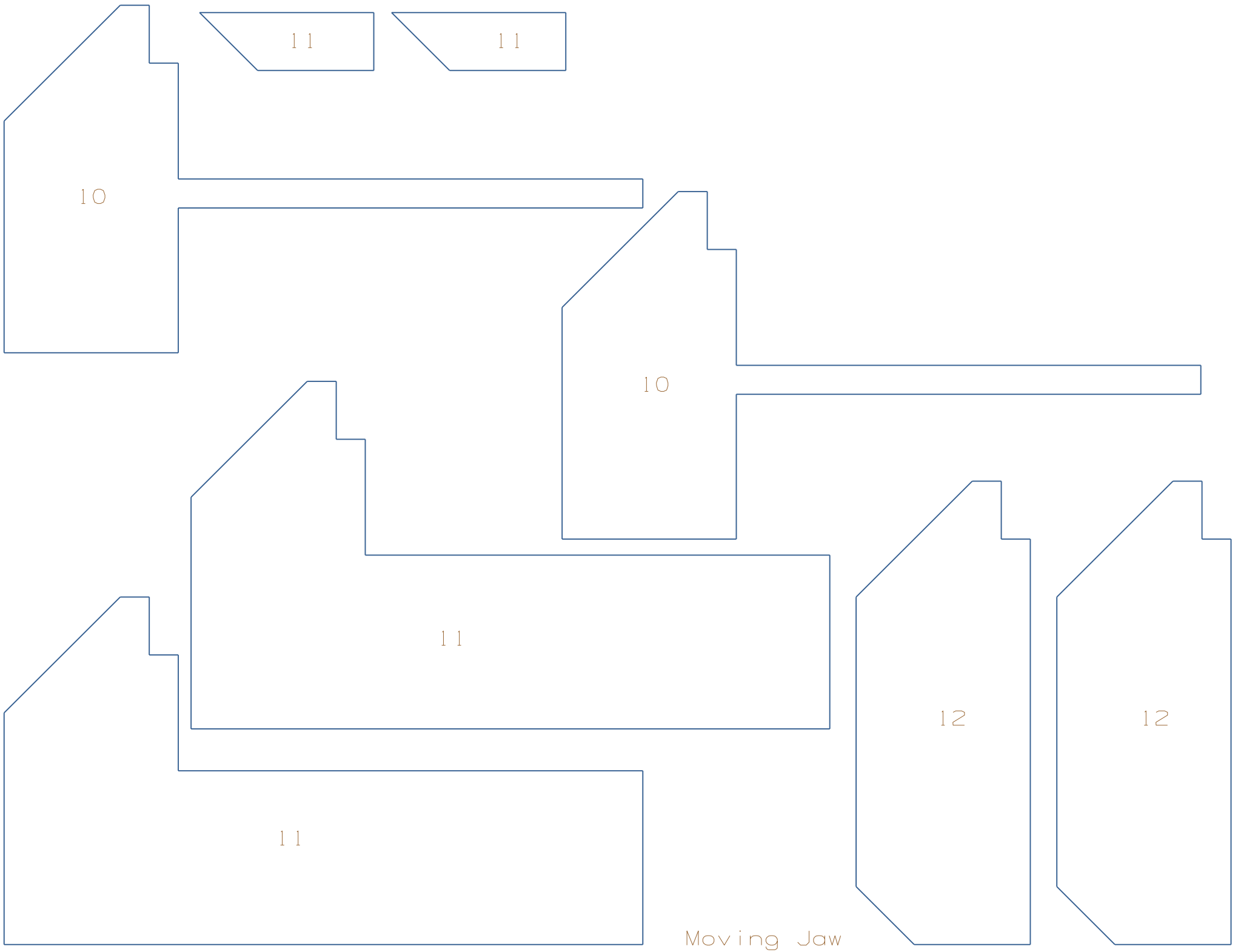

11

11

10

10

11

11

12

12

Moving Jaw

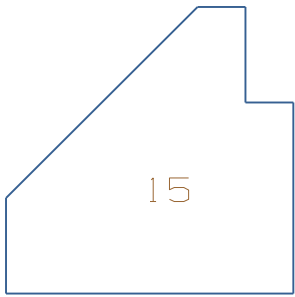
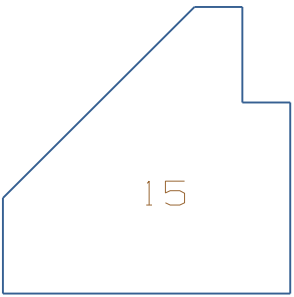
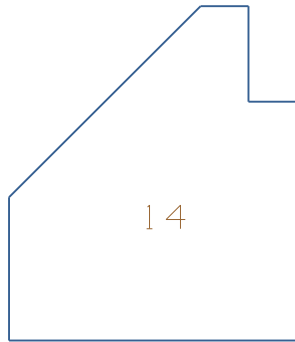
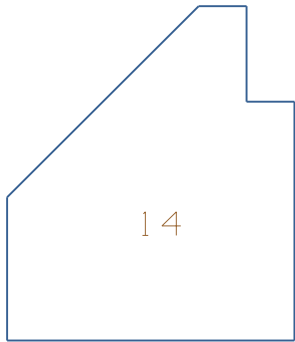
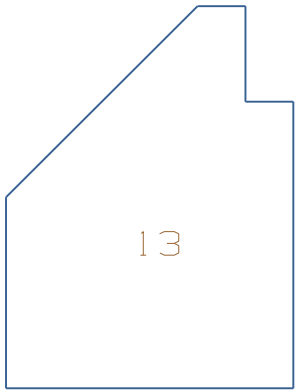
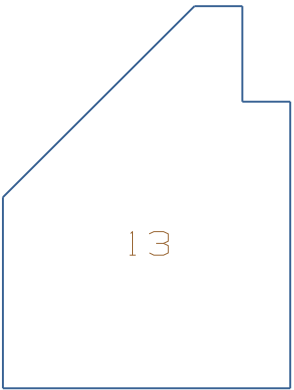
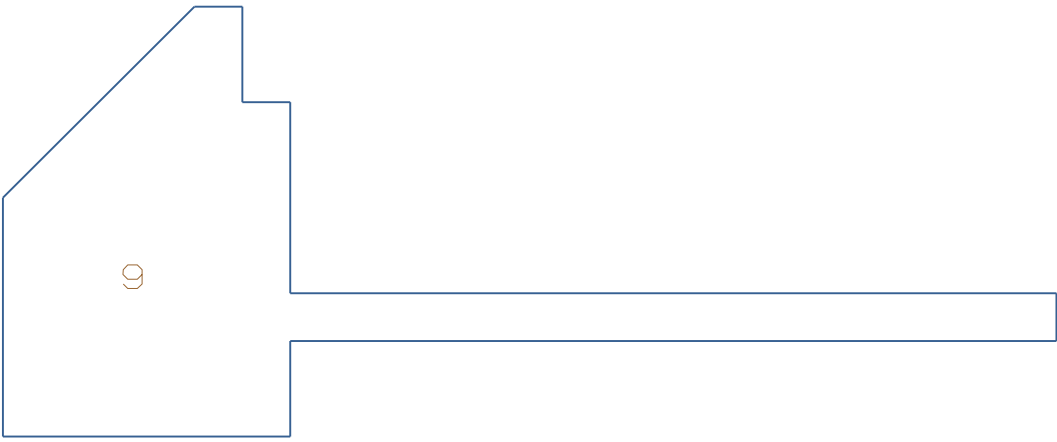

Moving Jaw