

**Input Section**

**Battery Charger**

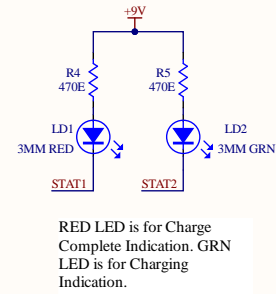

RED LED is for Charge Complete Indication. GRN LED is for Charging Indication.

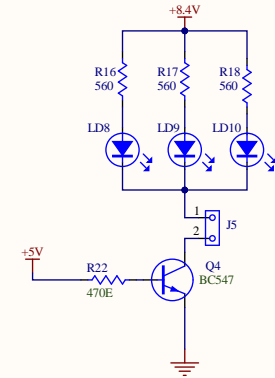

**Flashing Light 1**

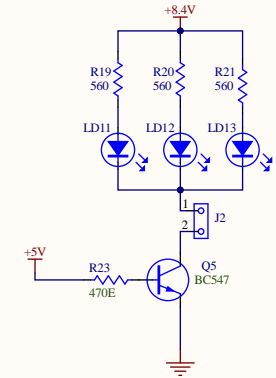

**Flashing Light 2**

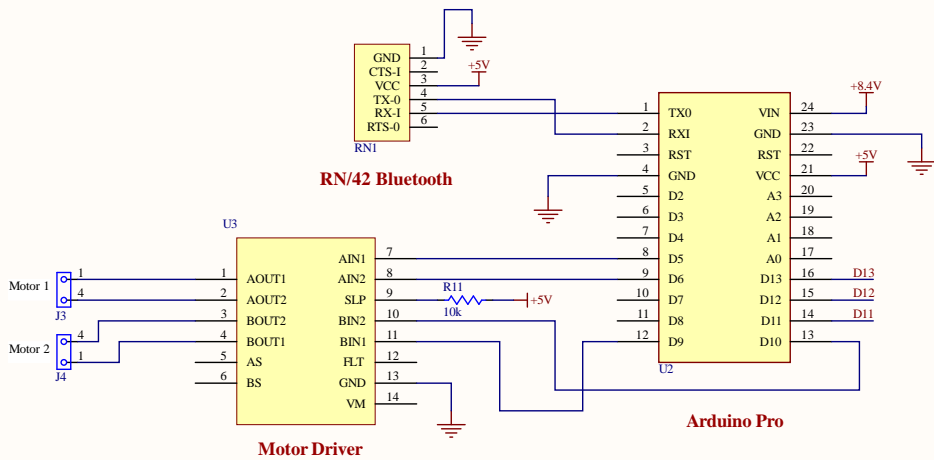

We have not connected anything to Vm, because the Module has terminal block in it use that don't use Vm pin it doesn't have protection

**Motor Driver**

**Arduino Pro**

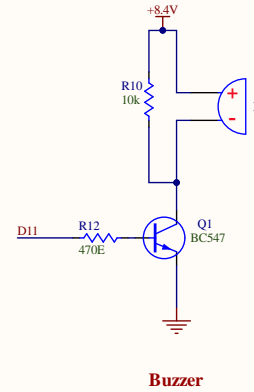

**Buzzer**

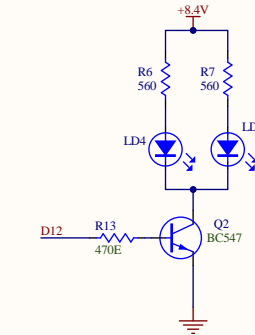

**Front HeadLight 1**

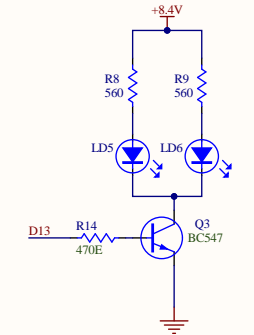

**Rear HeadLight 2**

Title		
Size	Number	Revision
A		
Date:	11/22/2022	Sheet of
File:	E:\Projects\...\RoboSch1.SchDoc	Drawn By:

