

# PAPER CHAIR

## Wood Skeleton & Paper Skin Construction

Design by Fabian Rätzel

### Materials:

Paper (at least 80g / m2)  
Lumber, 27x27mm  
Dowel stick, 8mm  
Wood glue  
Wood screws 4x35 mm  
Wallpaper glue (one pack of 200g)

### Tools:

Try Square & Protractor, Folding rule, Pencil  
Handsaw  
Powerdrill, 8mm & 3mm Drillbits, Screw bit  
Chisel & Handplane (not a must!)  
Sanding Paper  
Brush  
Screw clamps (4 pcs)

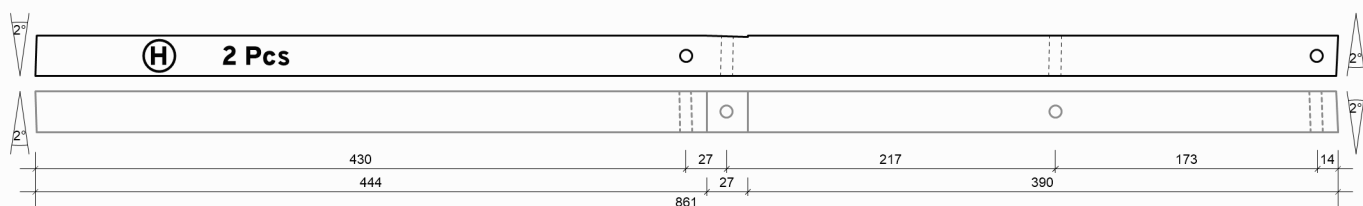
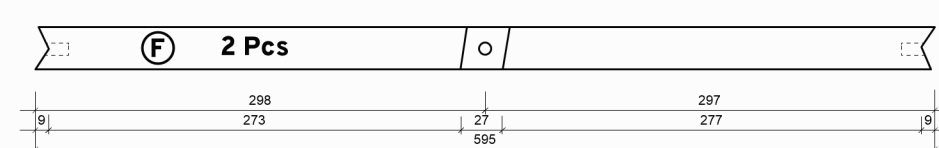
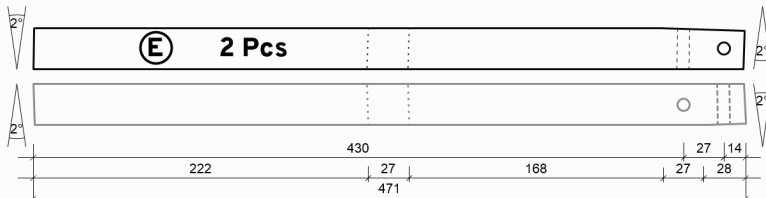
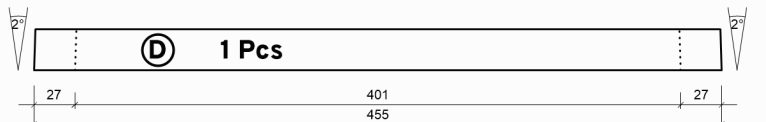
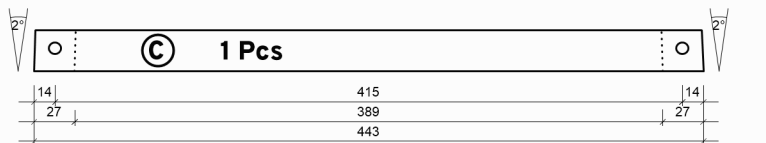
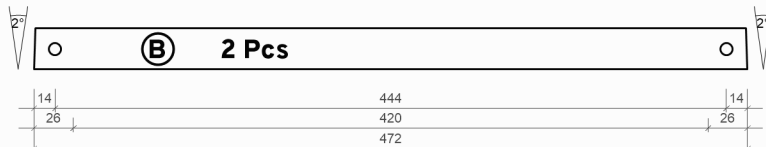
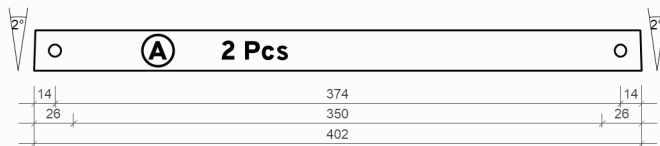
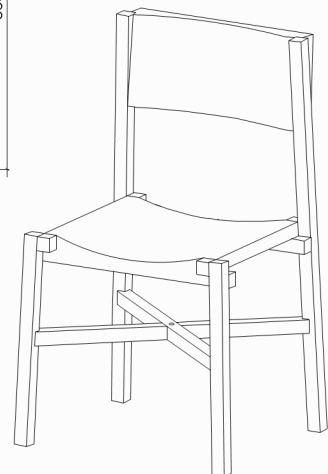
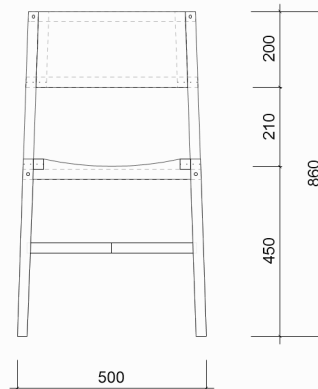
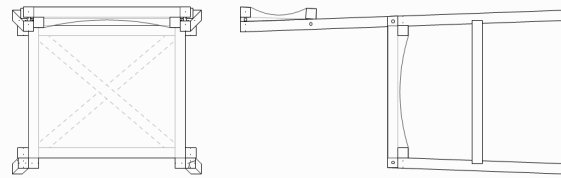

### Dowels from 8mm rod

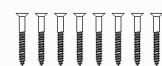
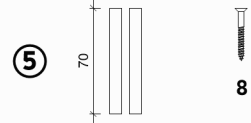
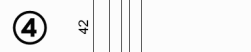
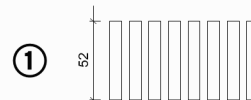

8 wood screws 4x35mm

