

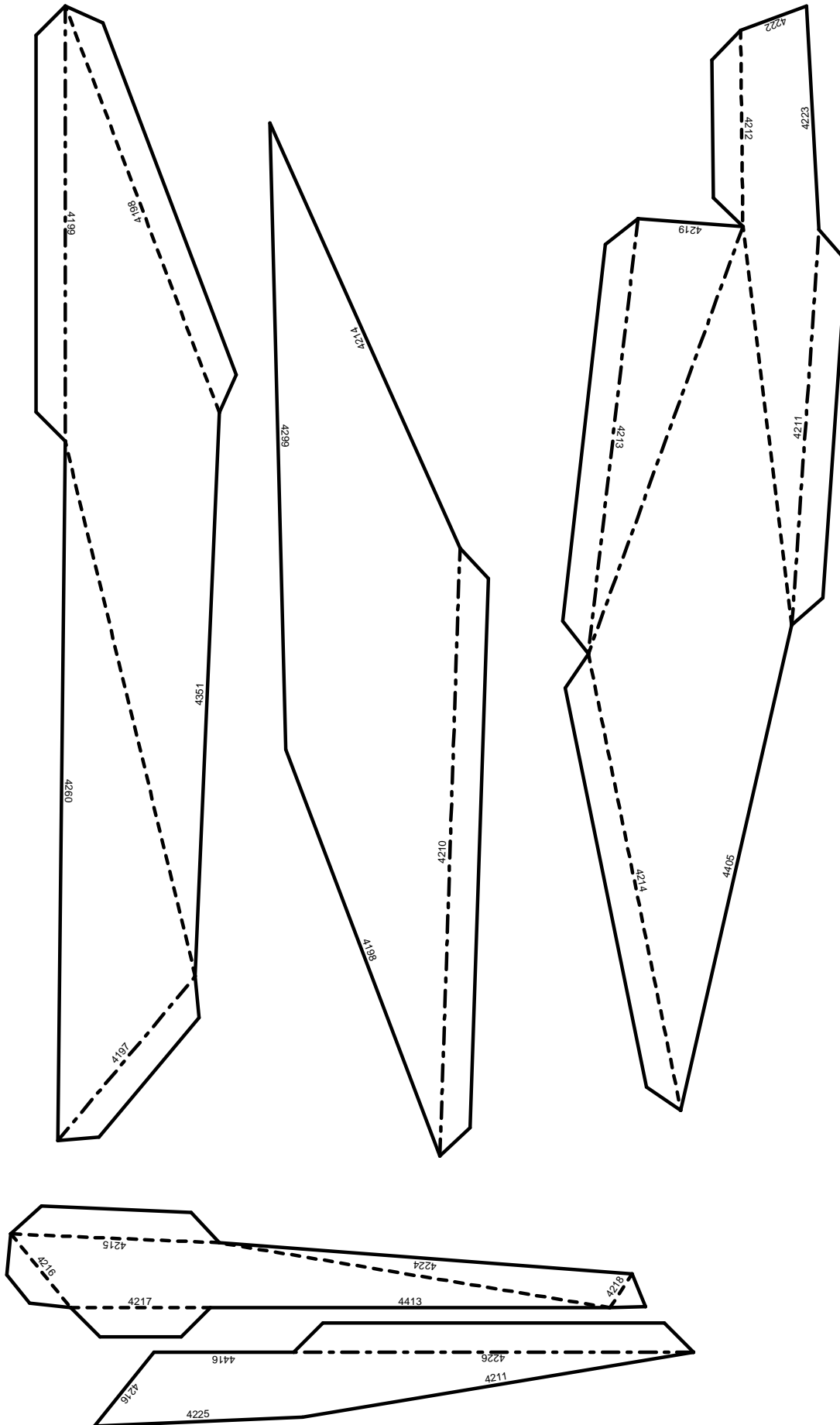

PaperCraft : #The_Selfie_Edition

This is part of a tutorial on
instructables.com called
"PaperCraft : #The_Selfie_Edition"
For any questions or comments or
to send me pics of your completed
model, please contact me on
instructables.com

Thank You!
Stuart Carlisle



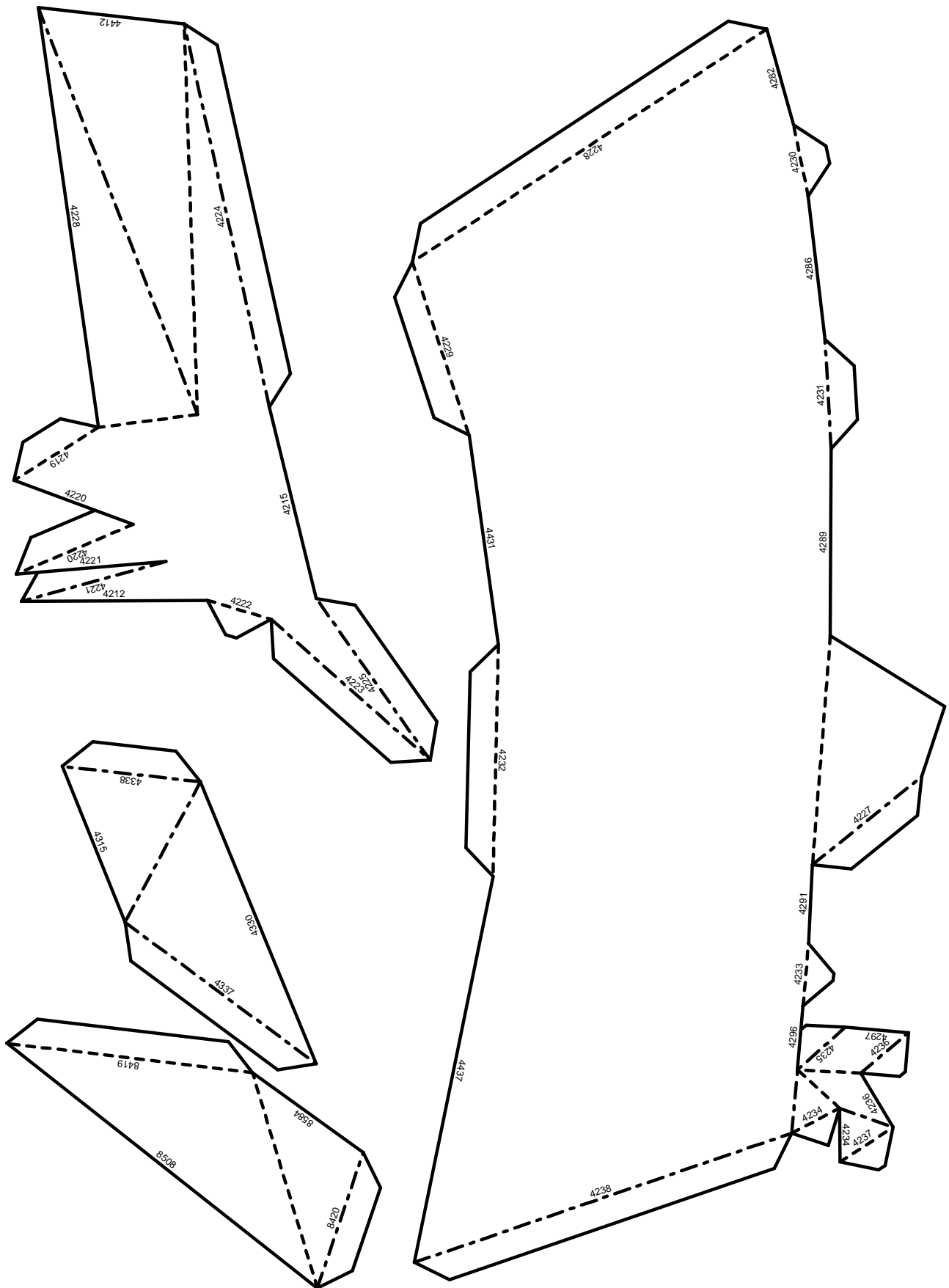

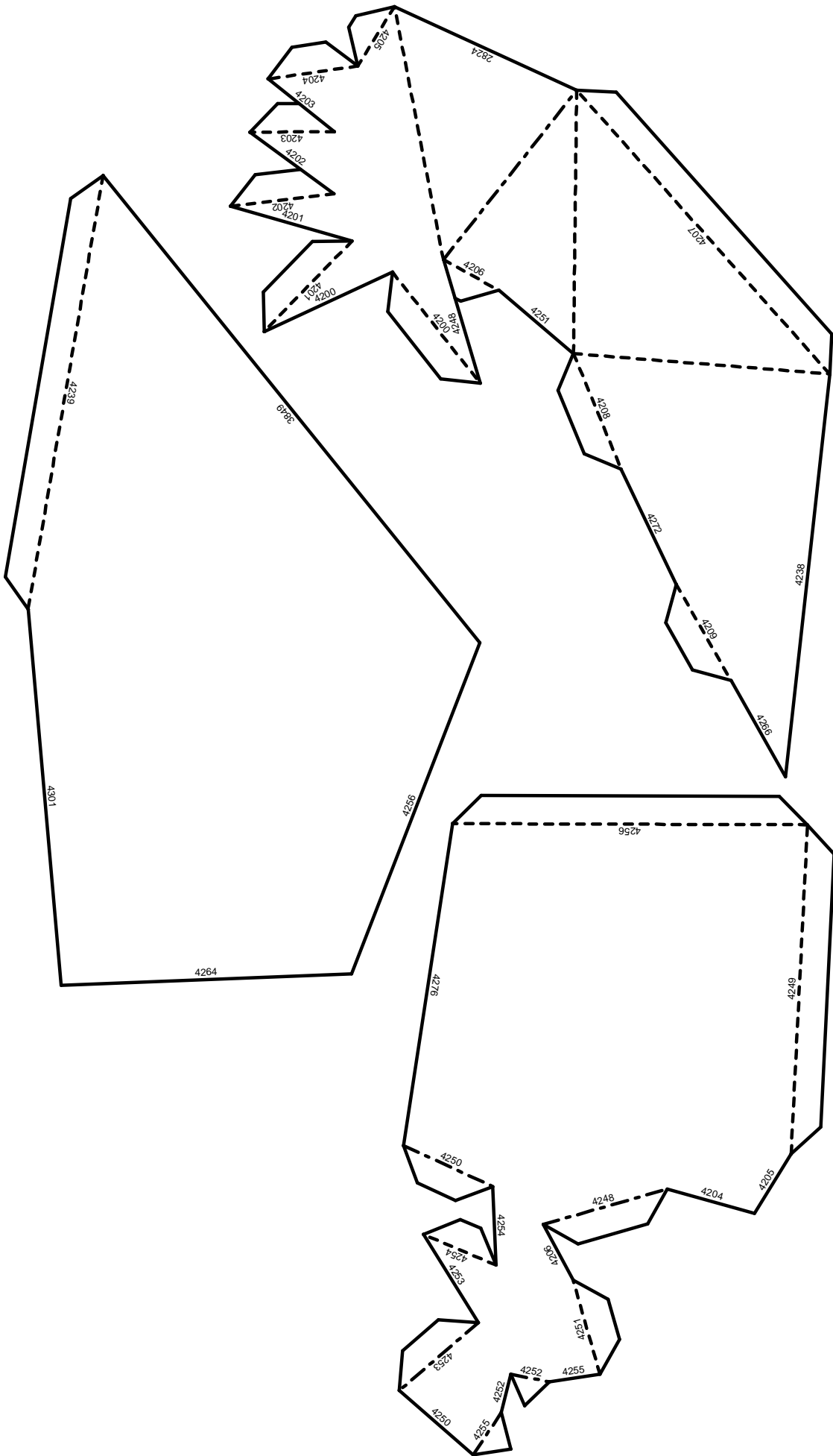

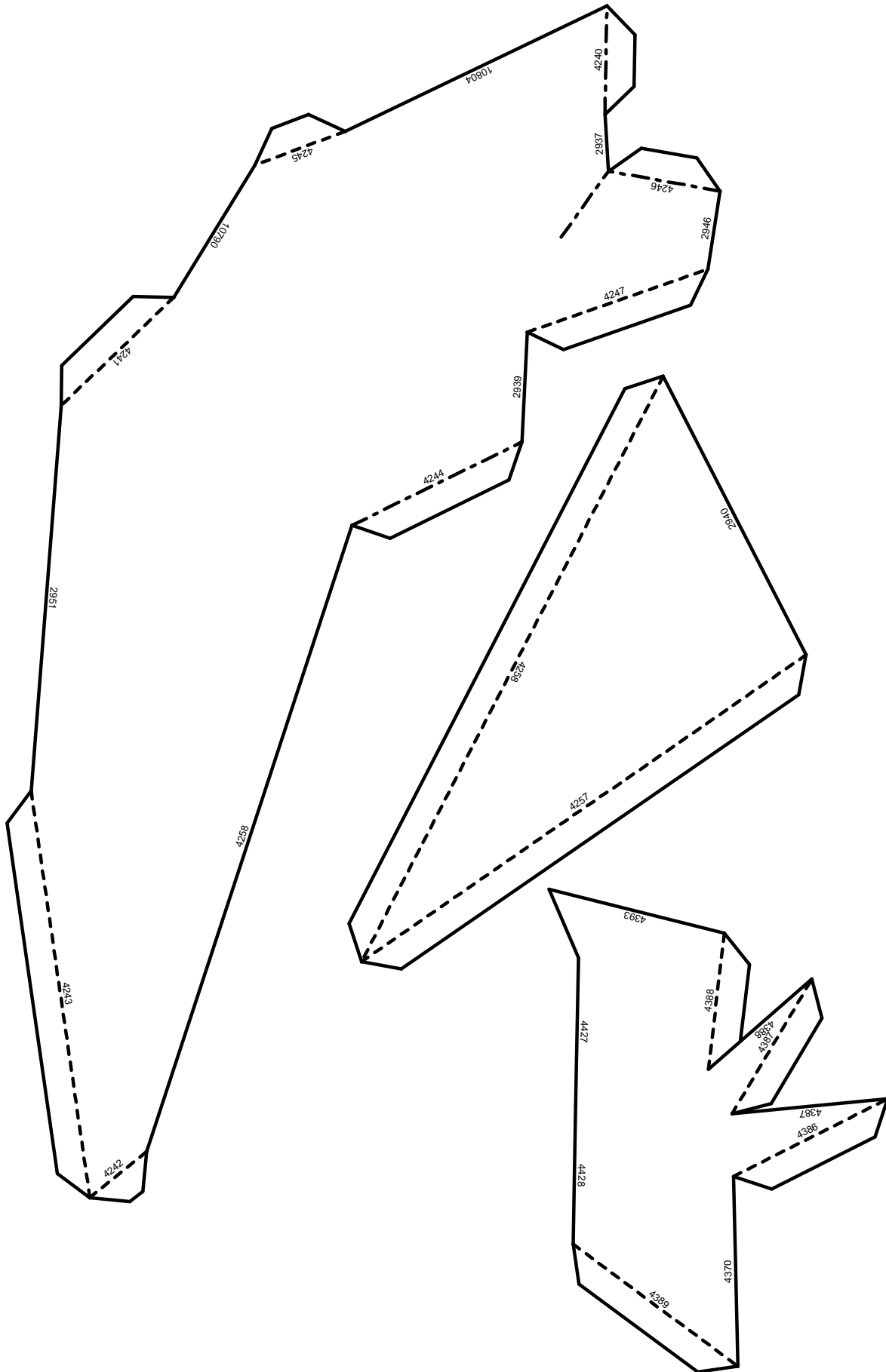

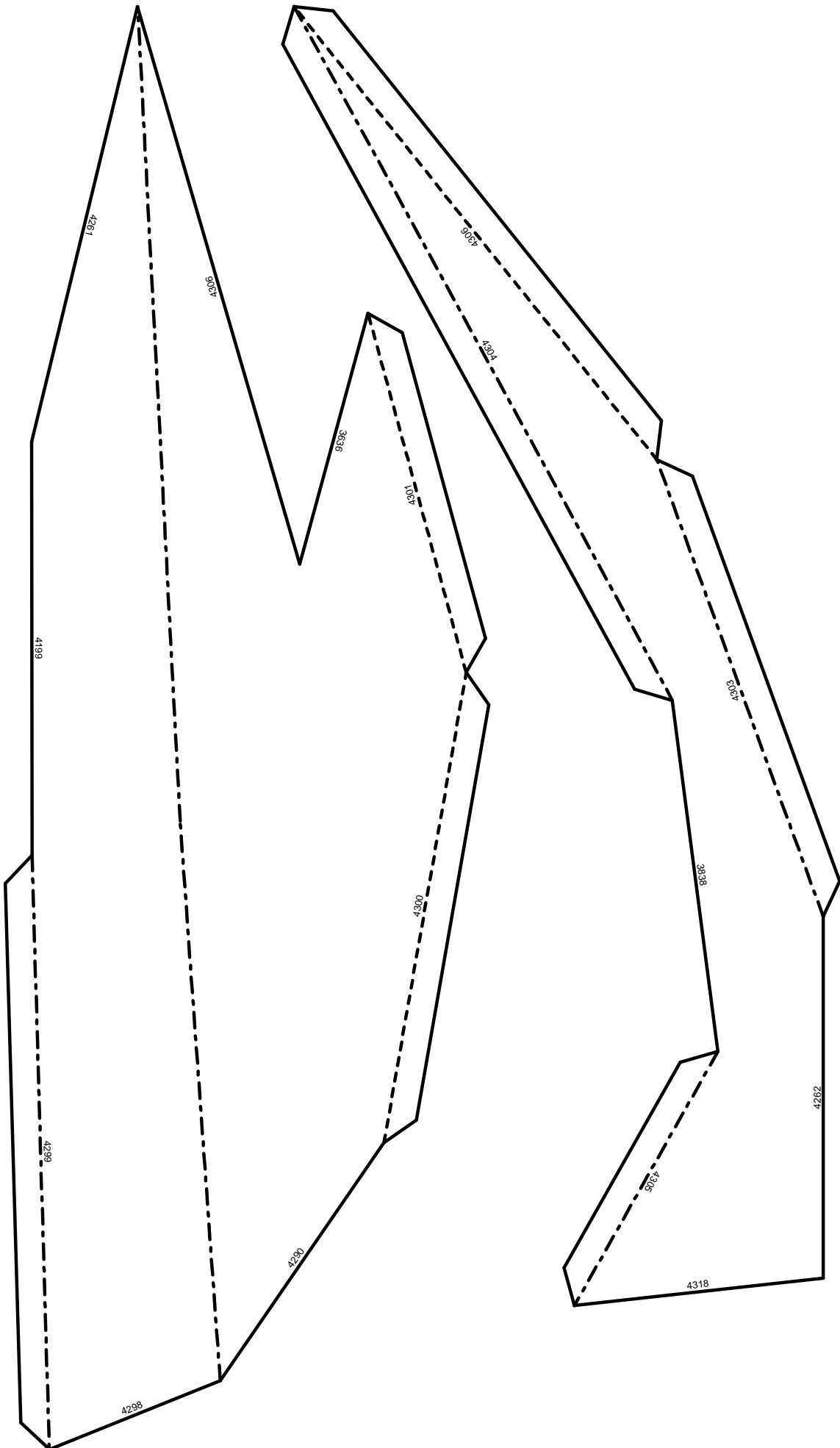

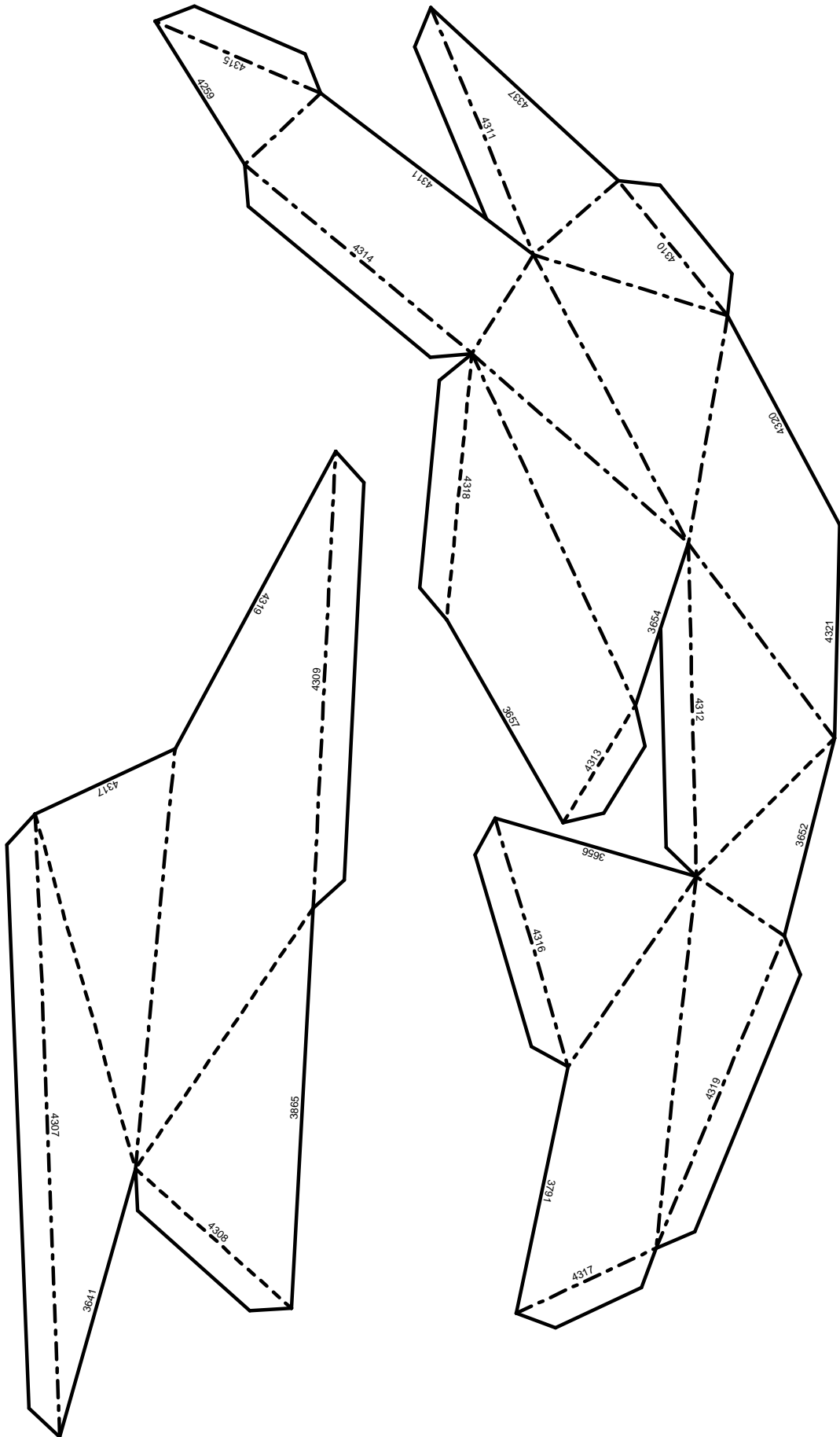

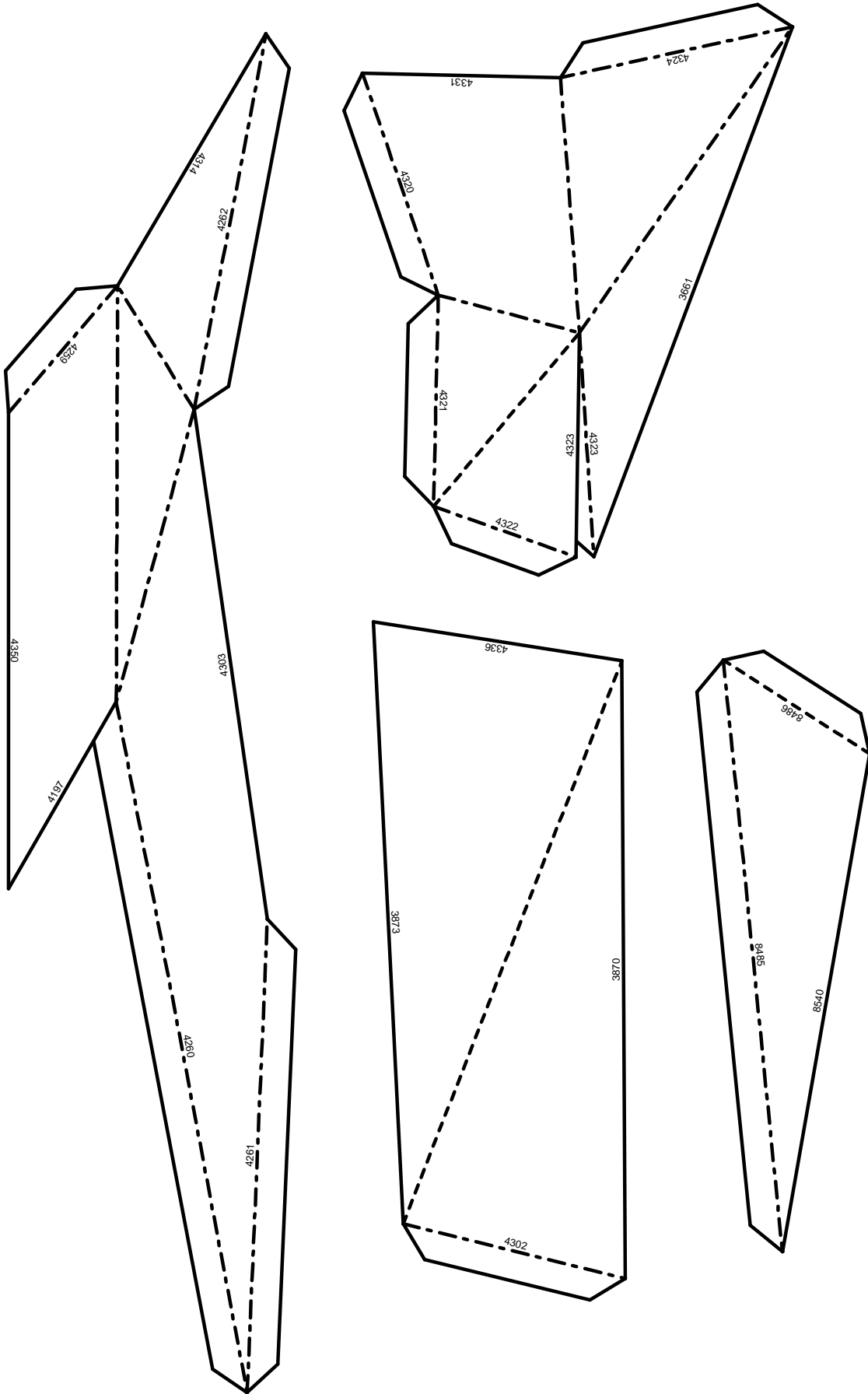

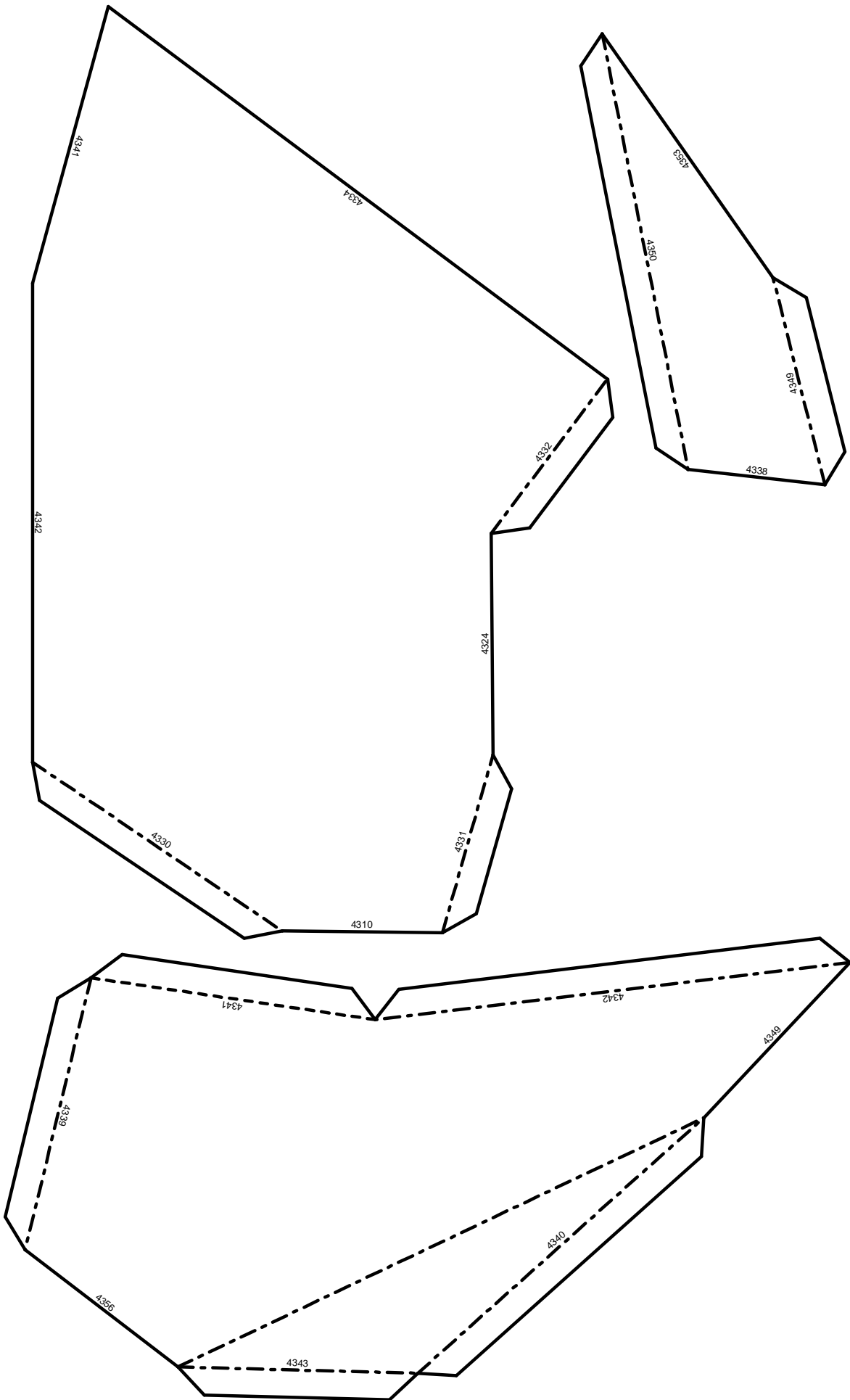

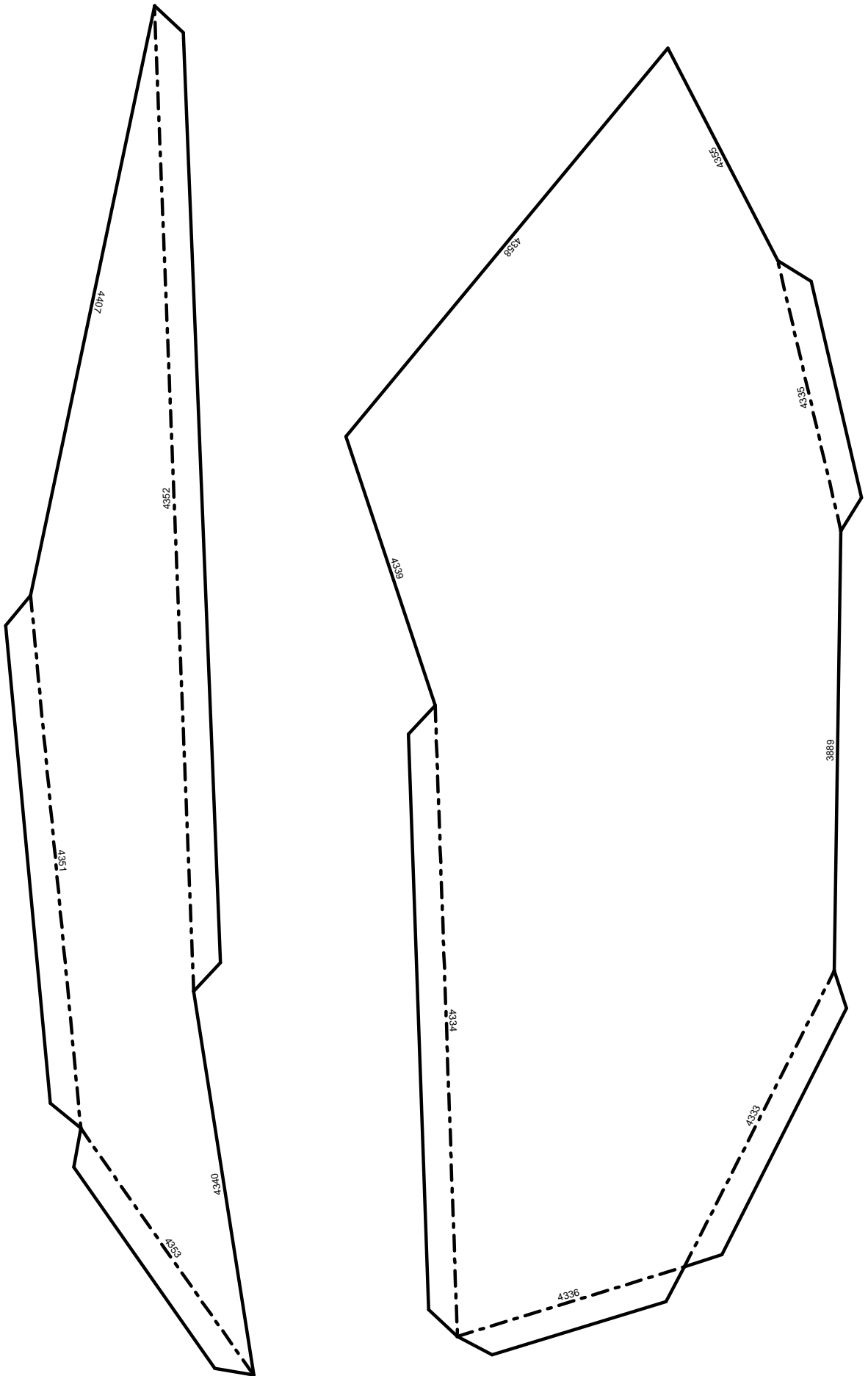

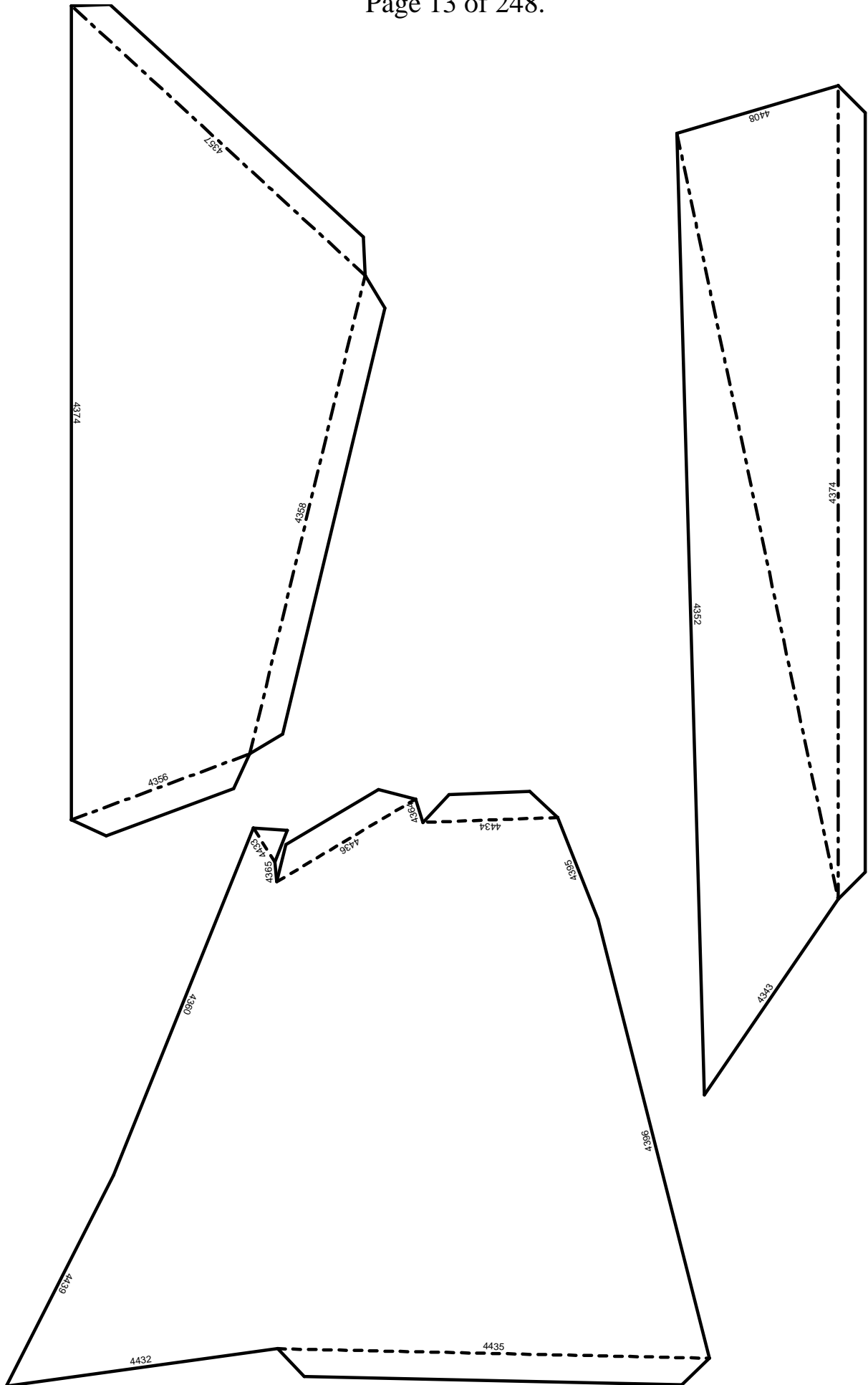

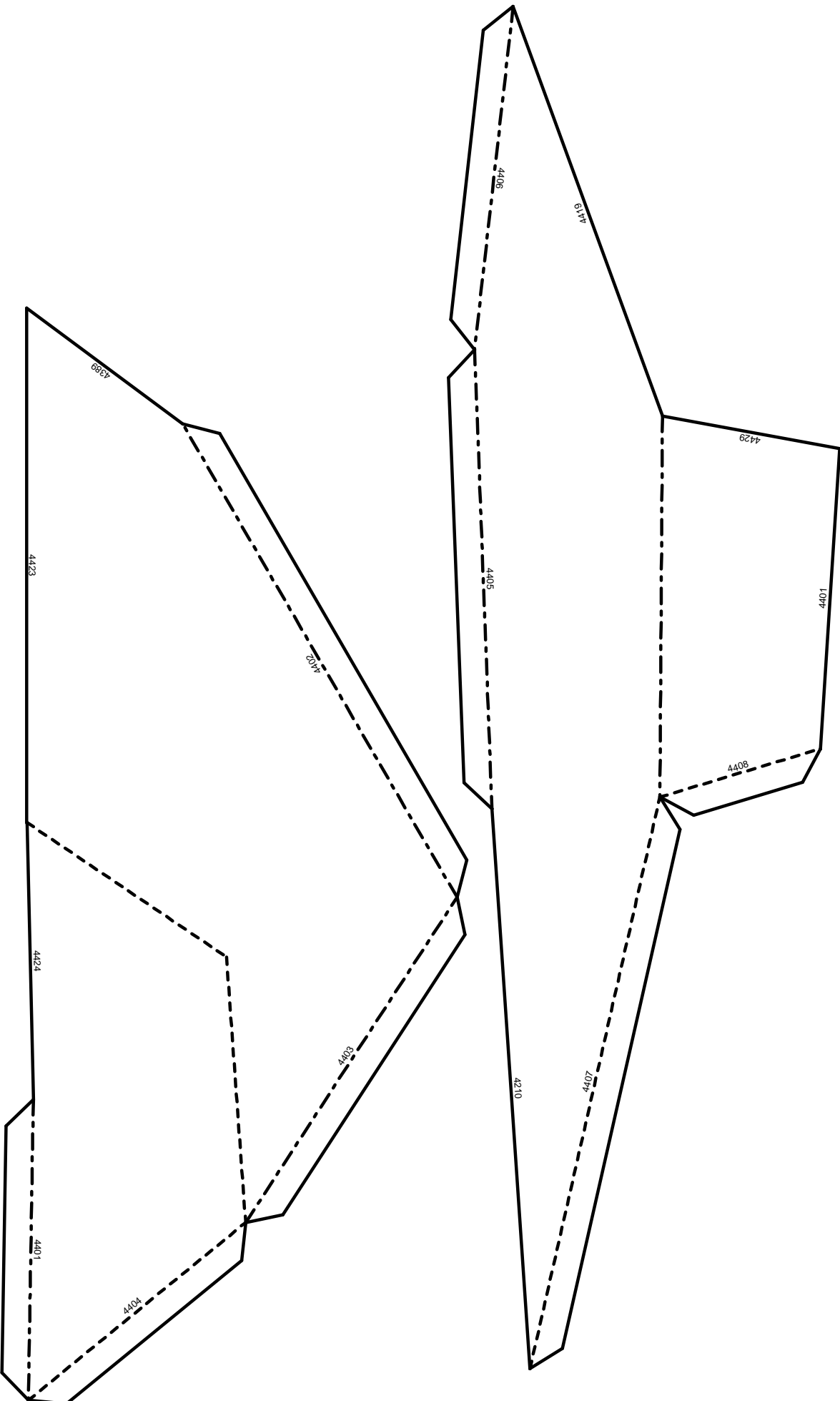

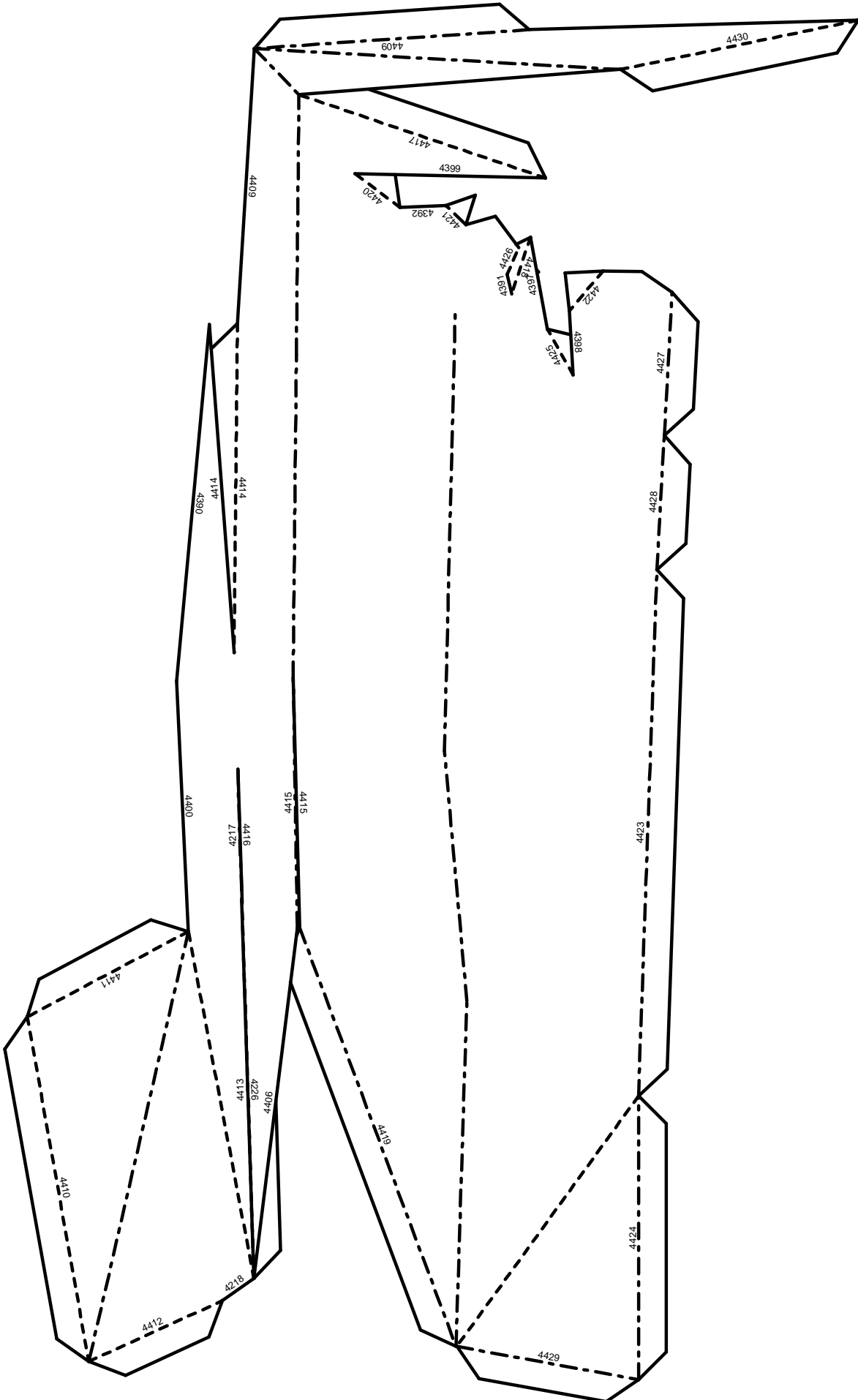

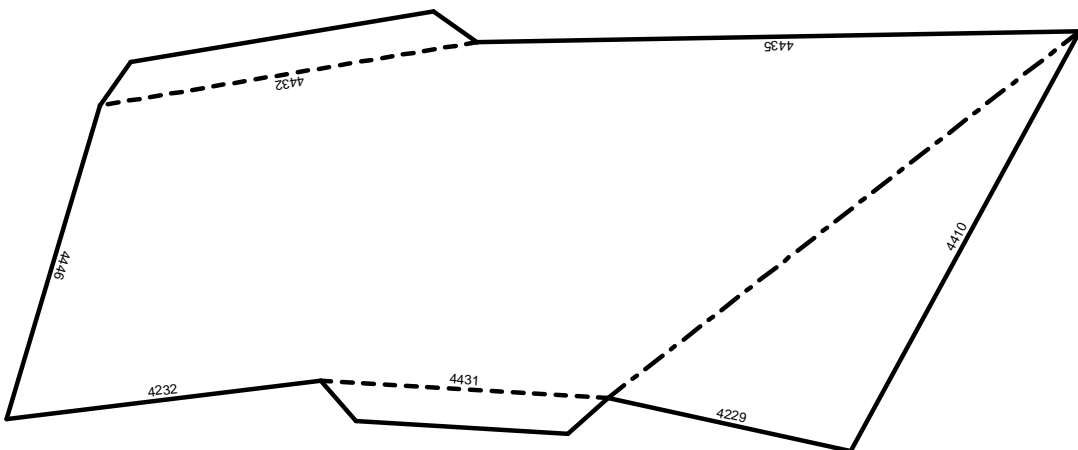
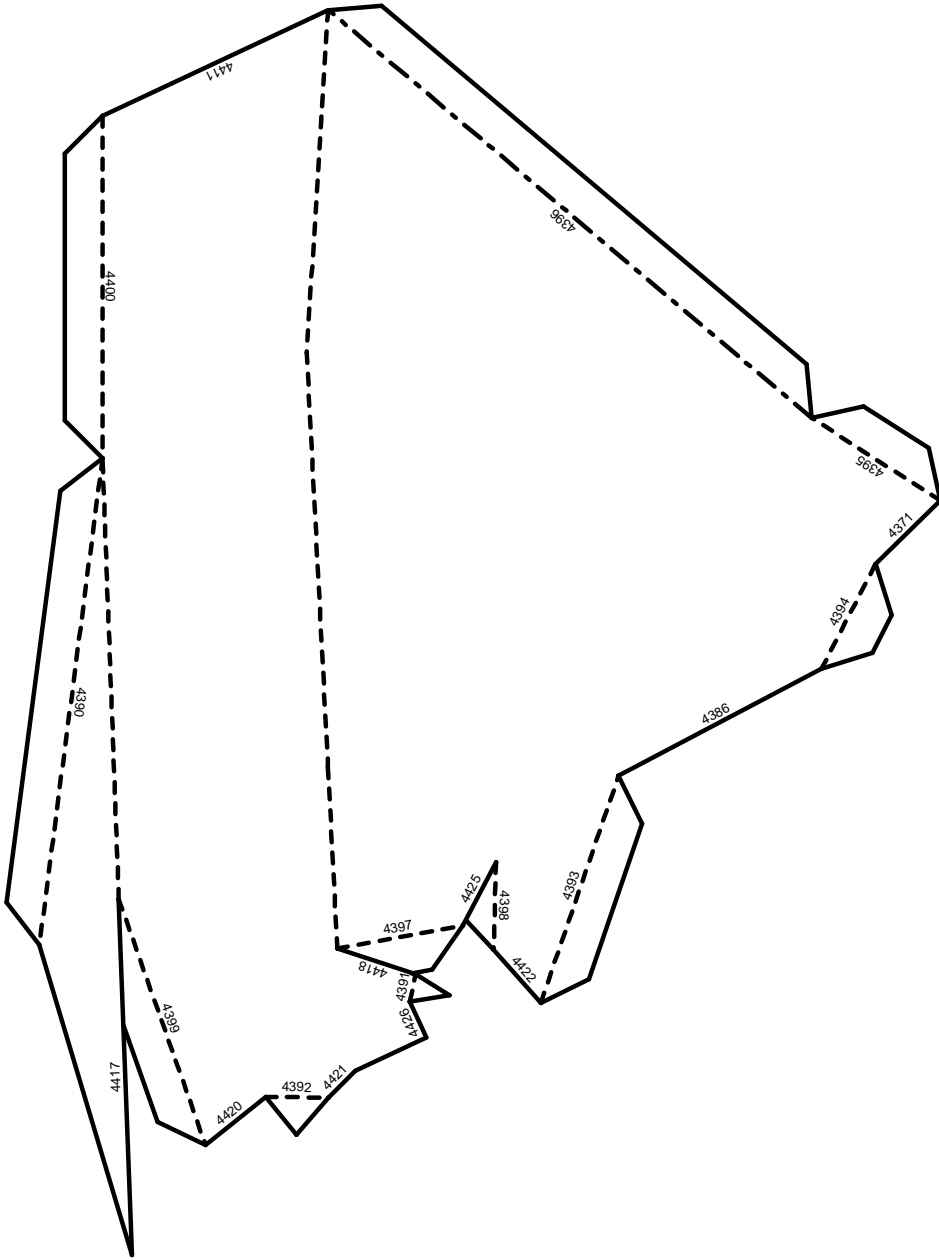

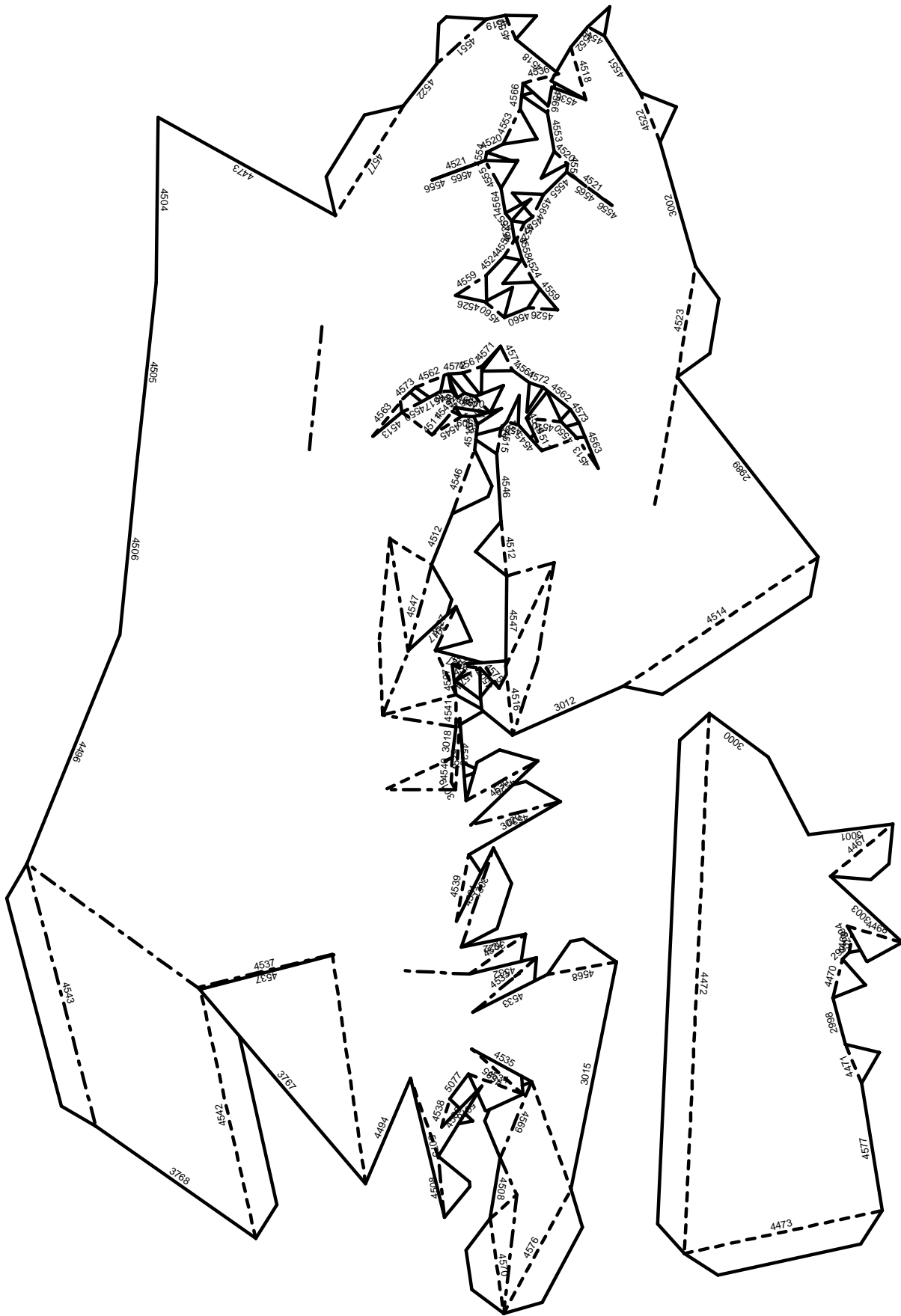

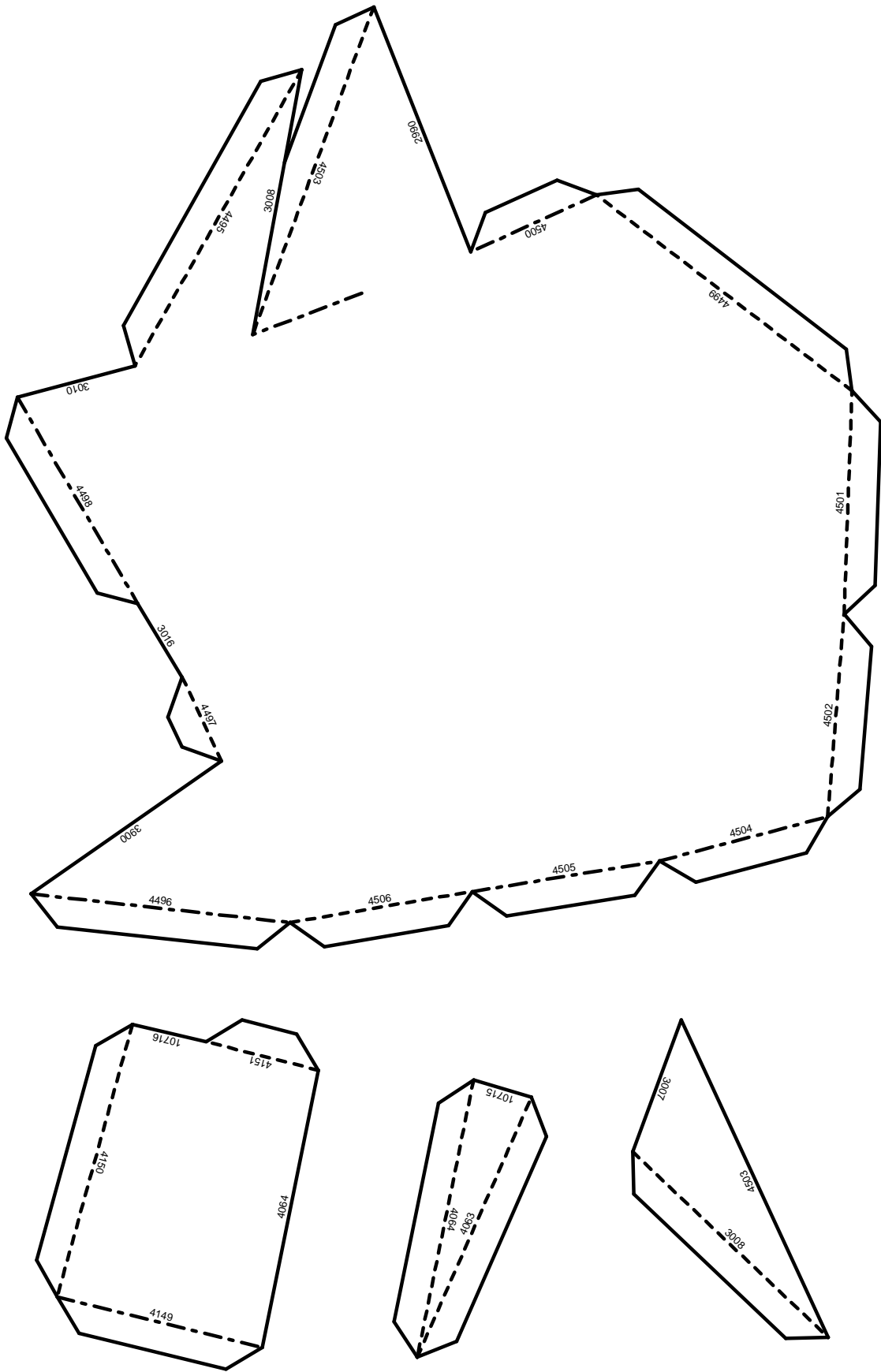

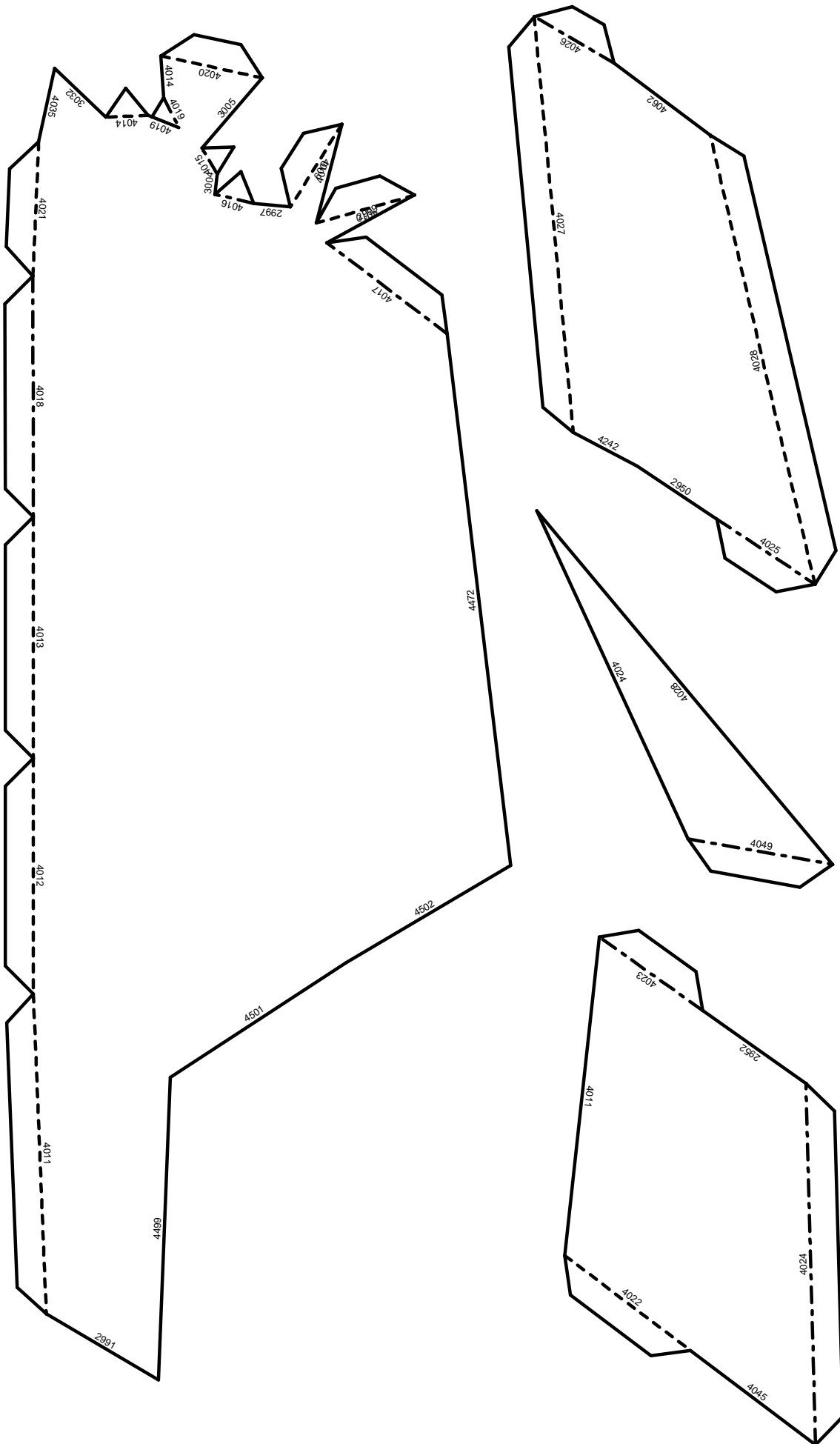

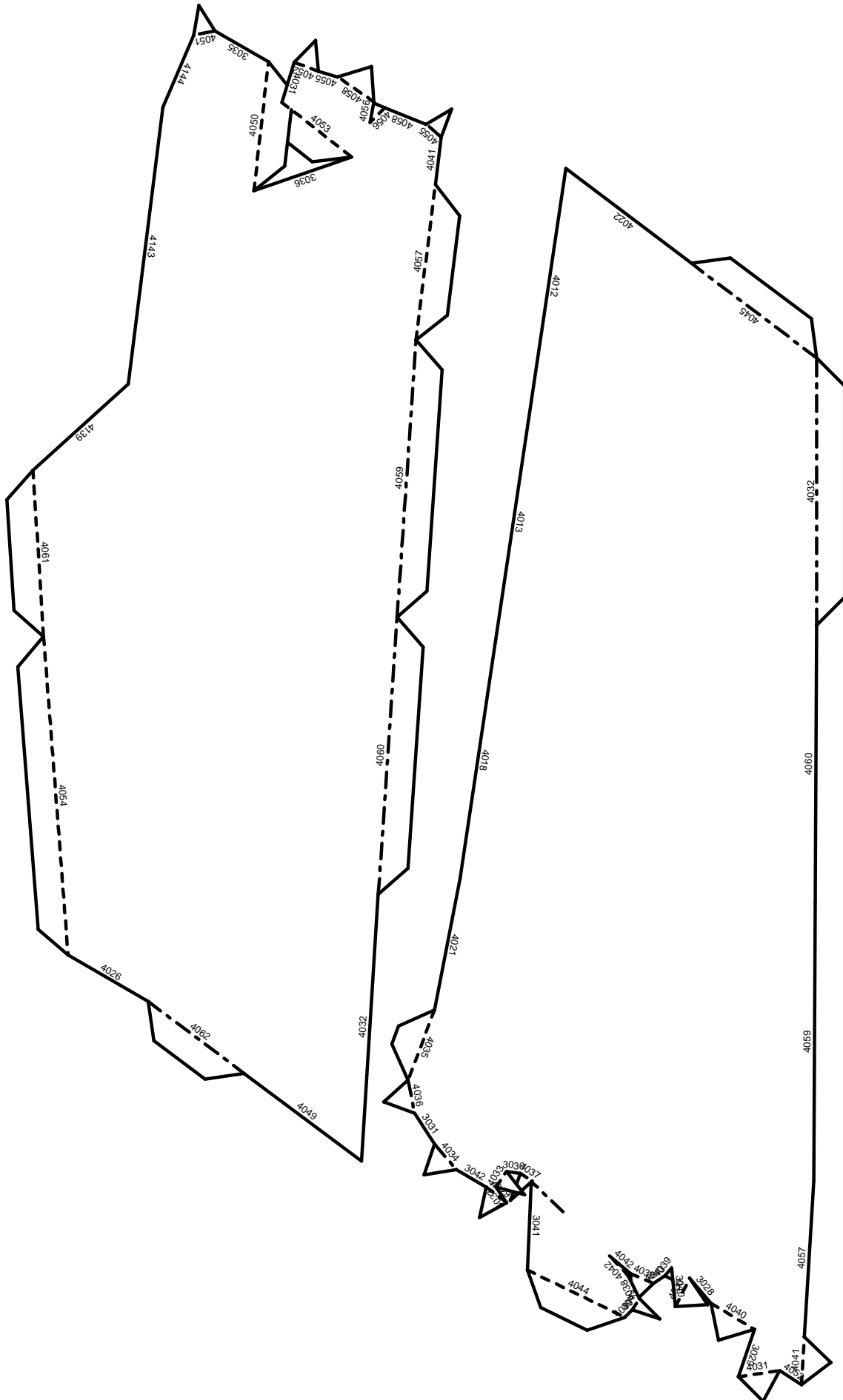

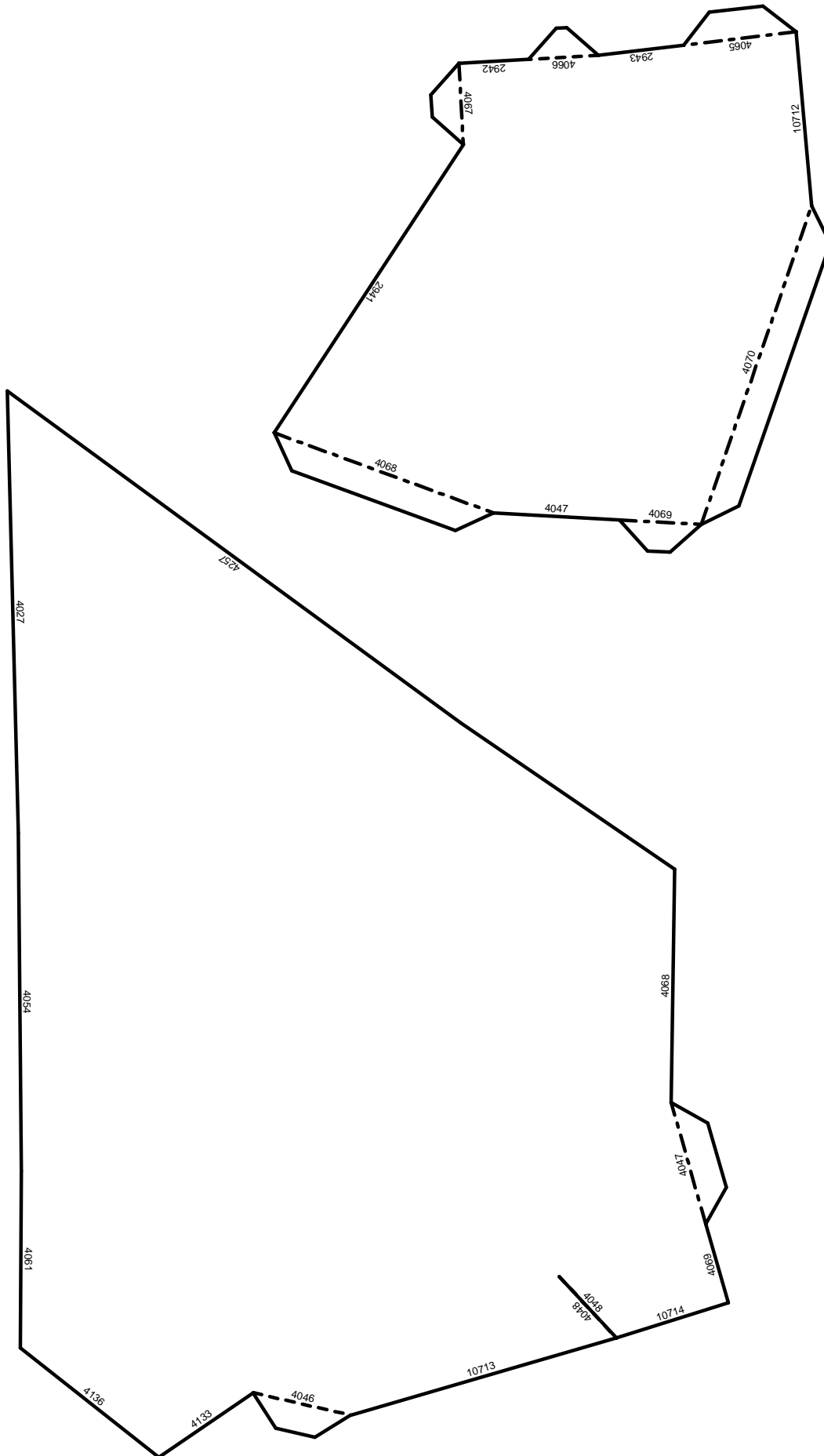

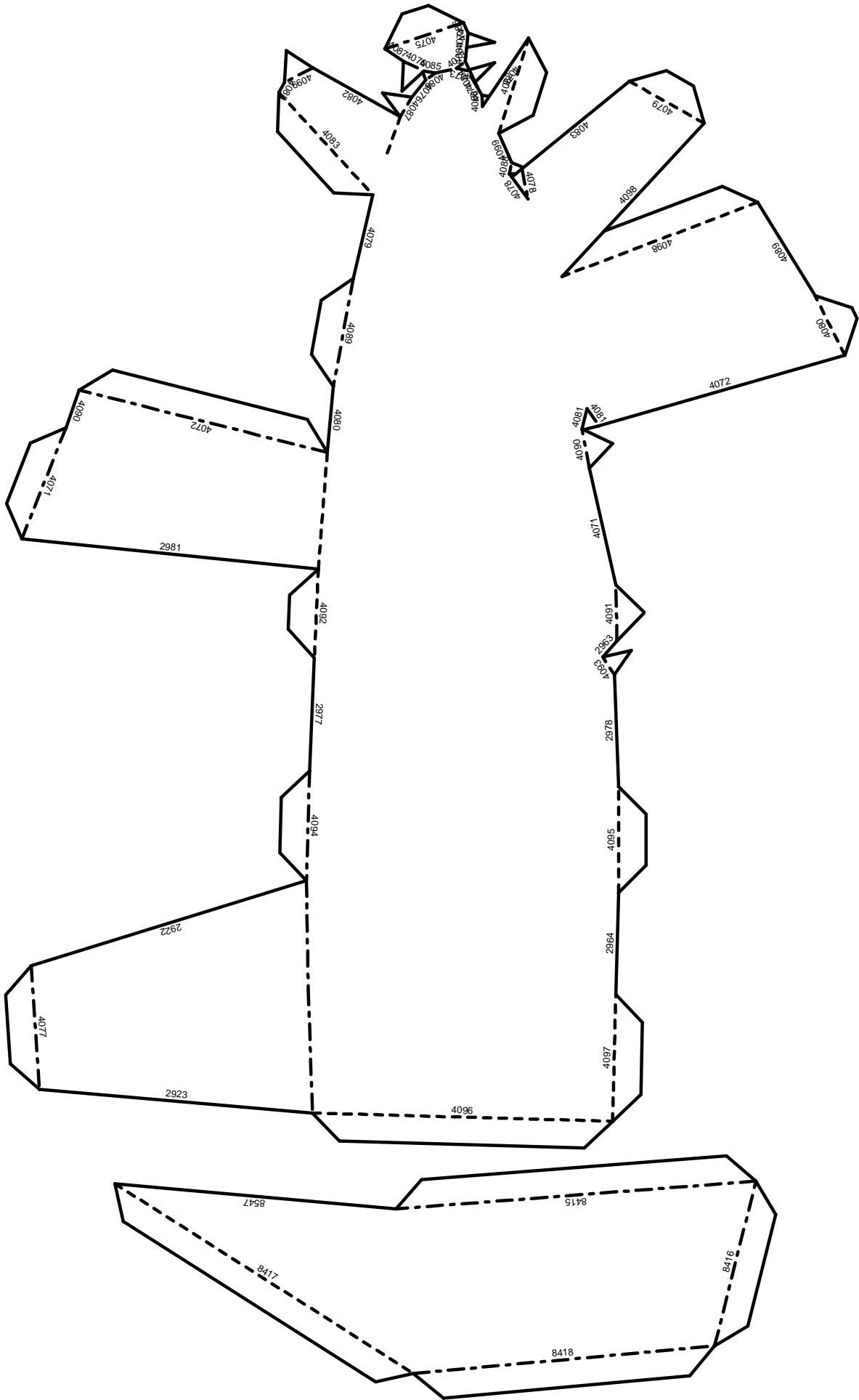

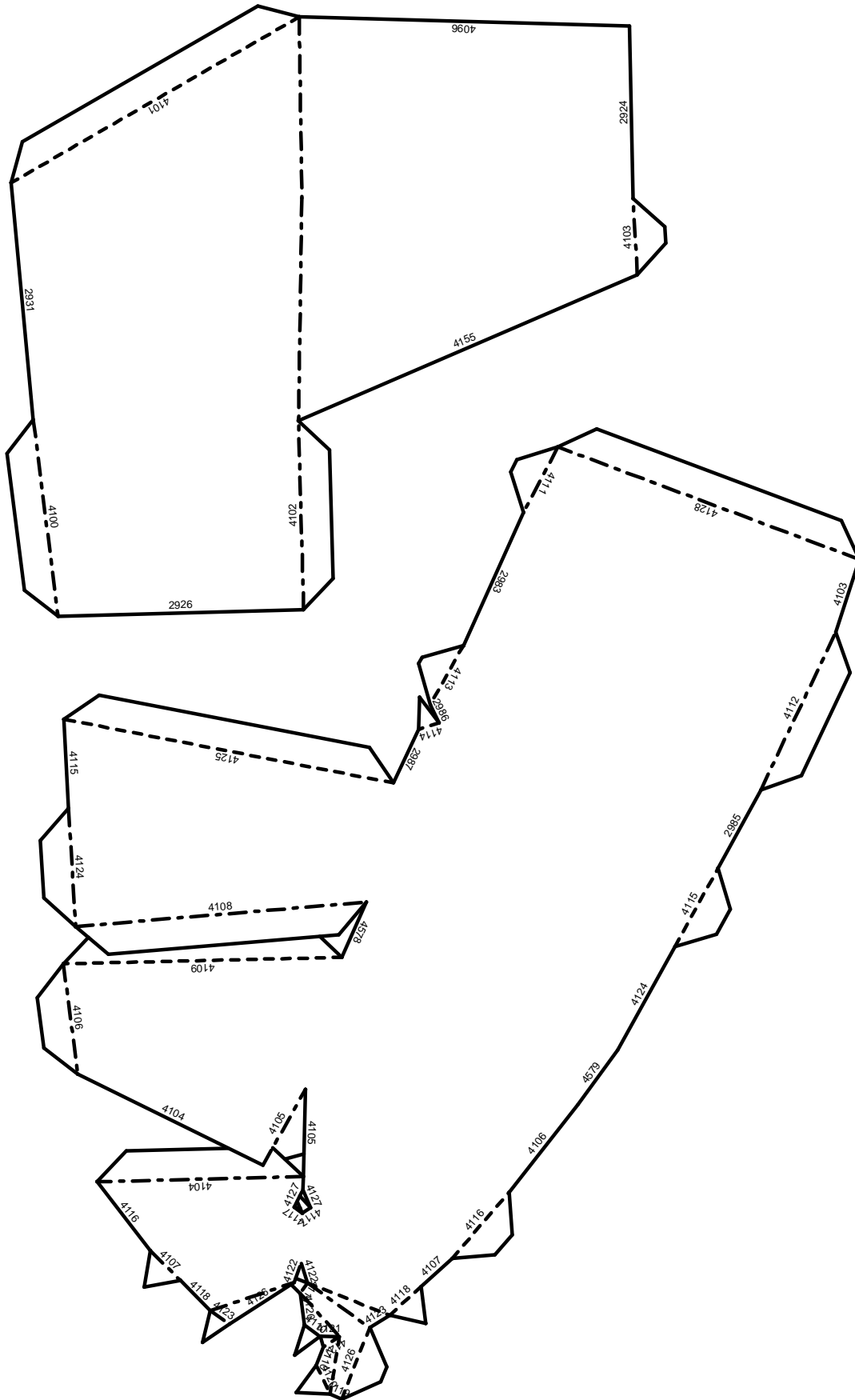

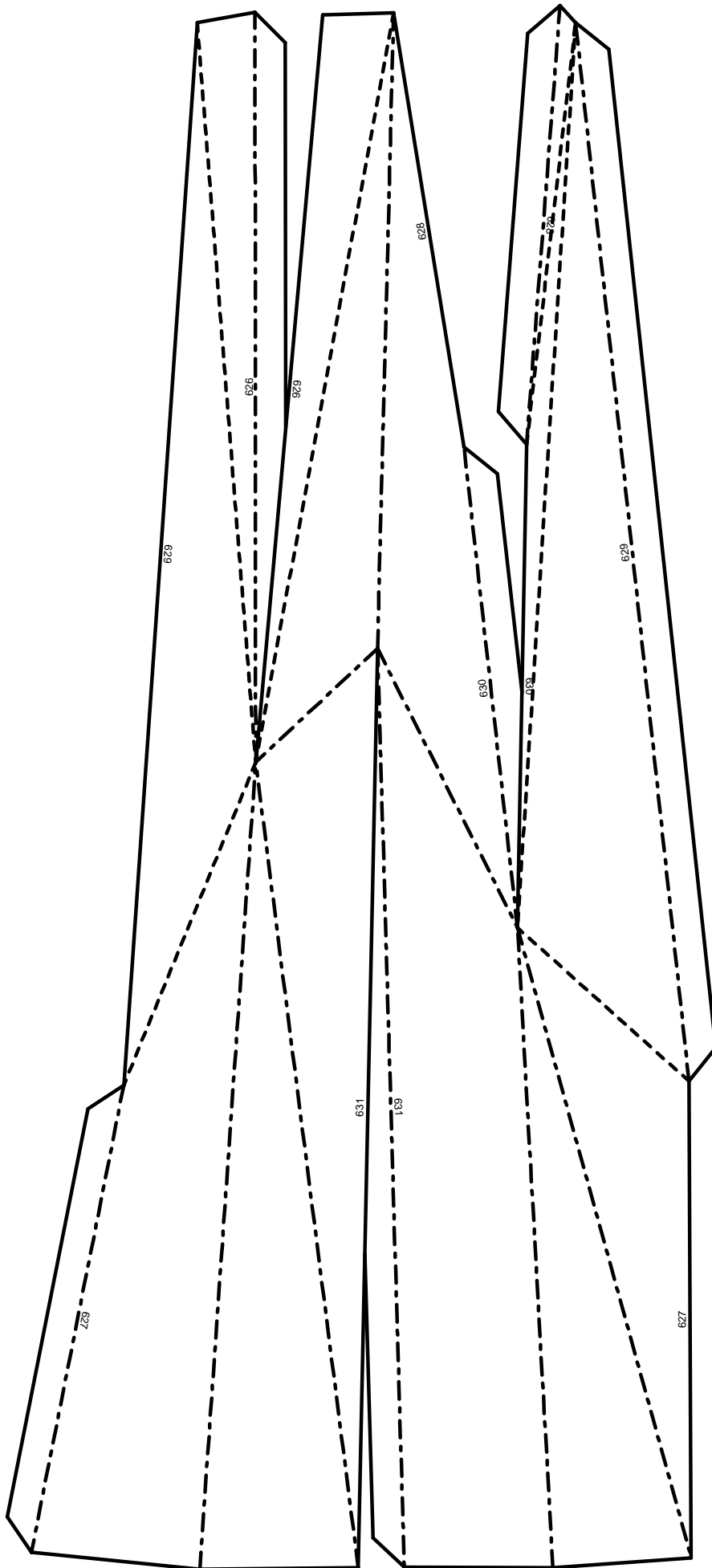

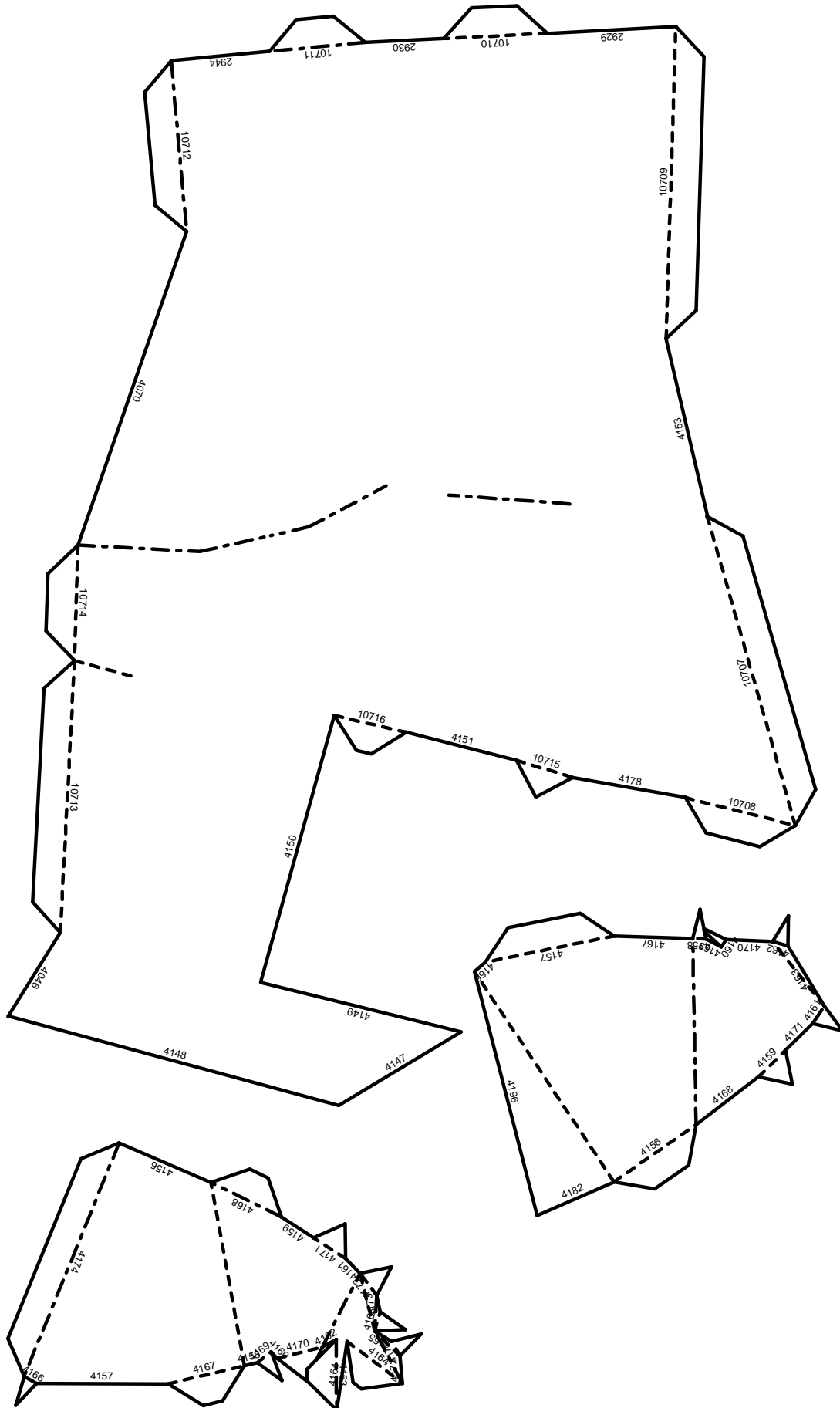

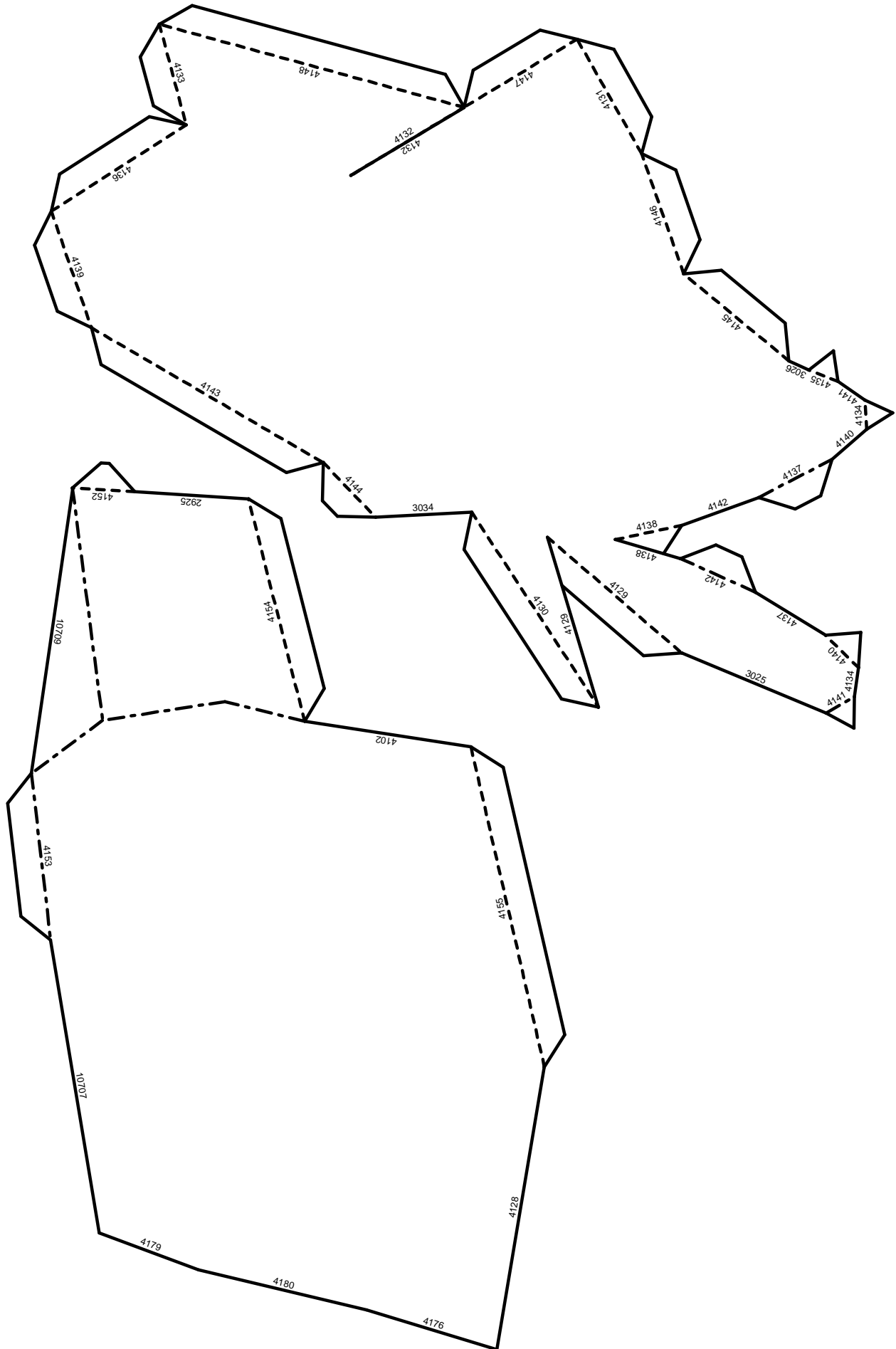

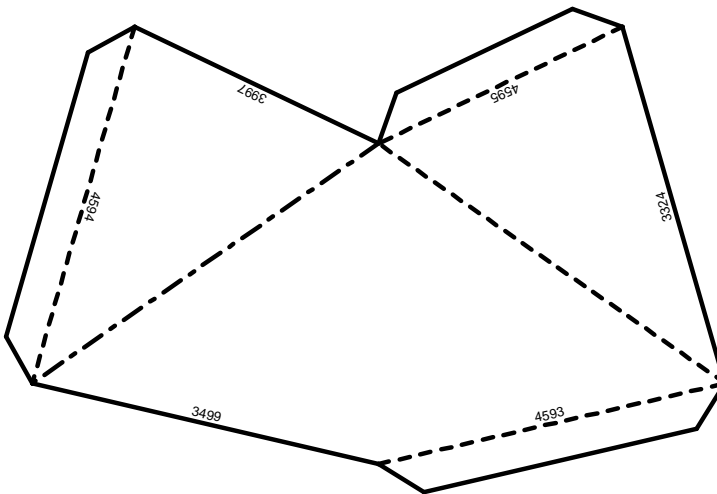
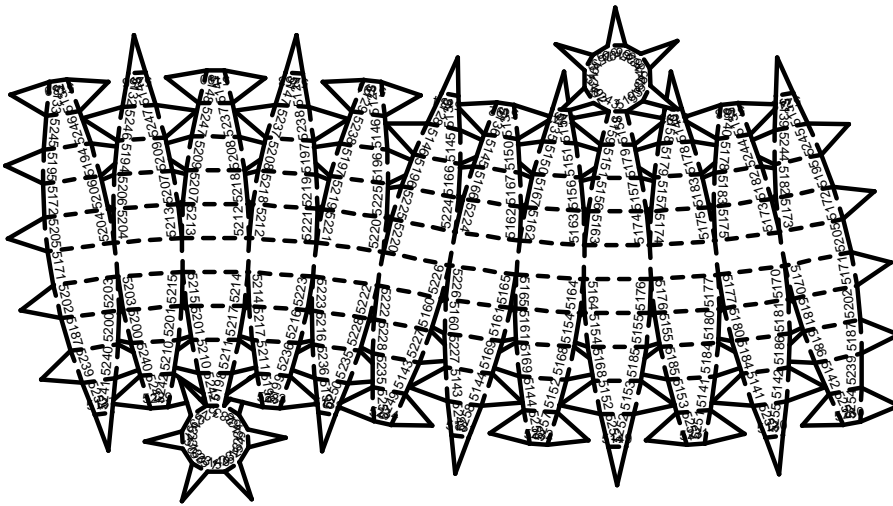
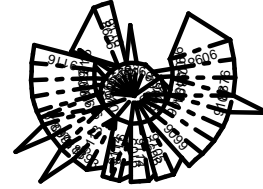
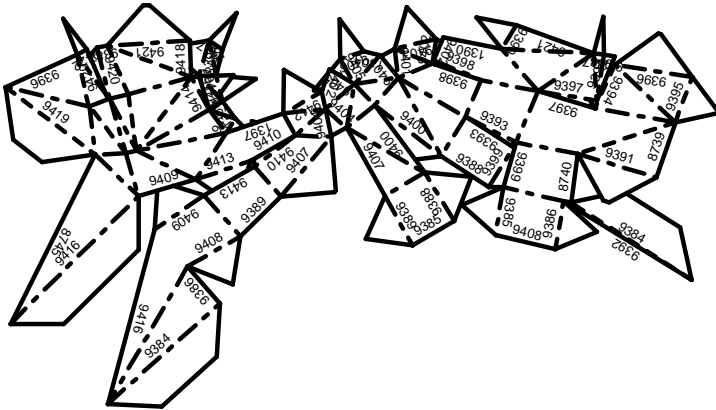

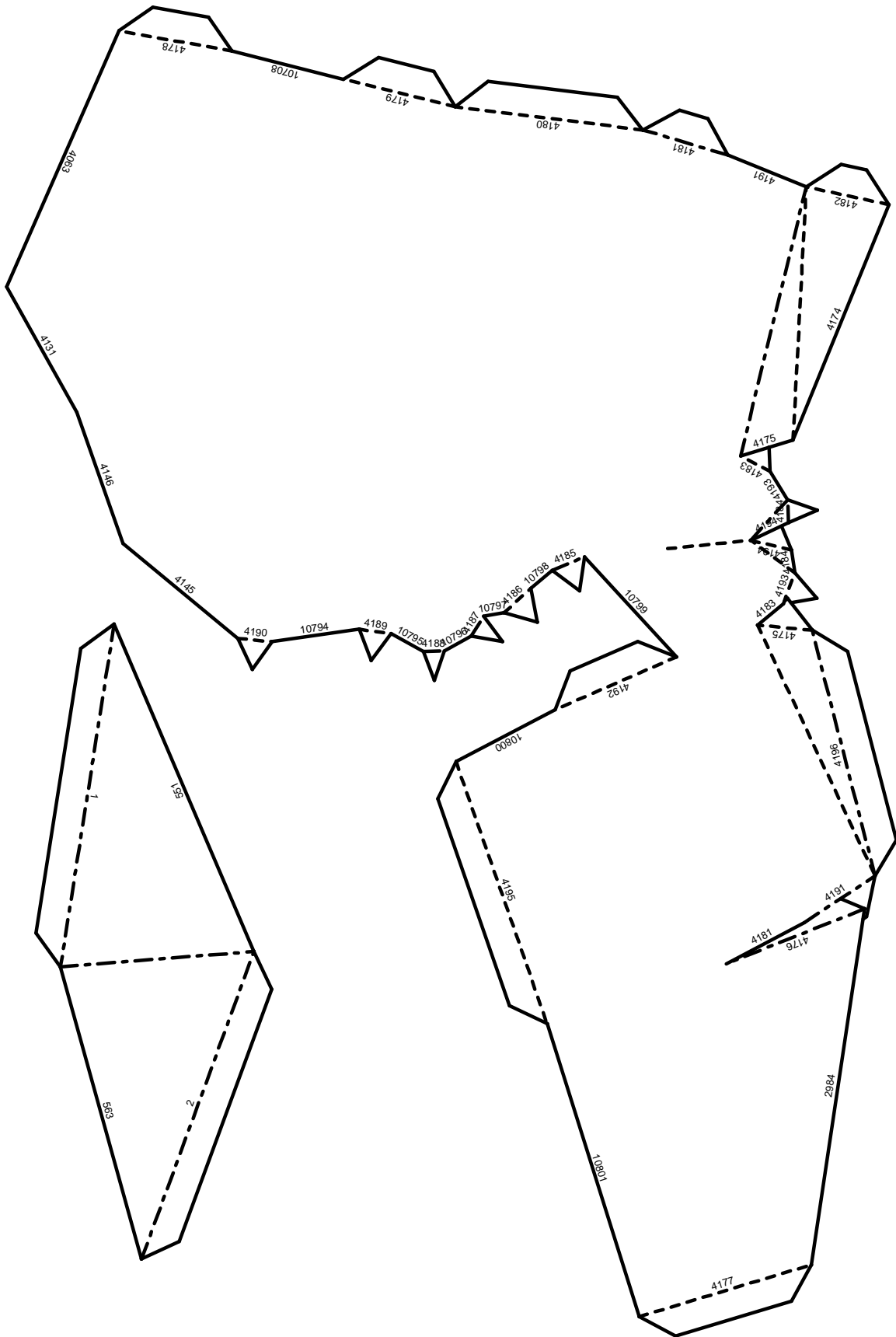

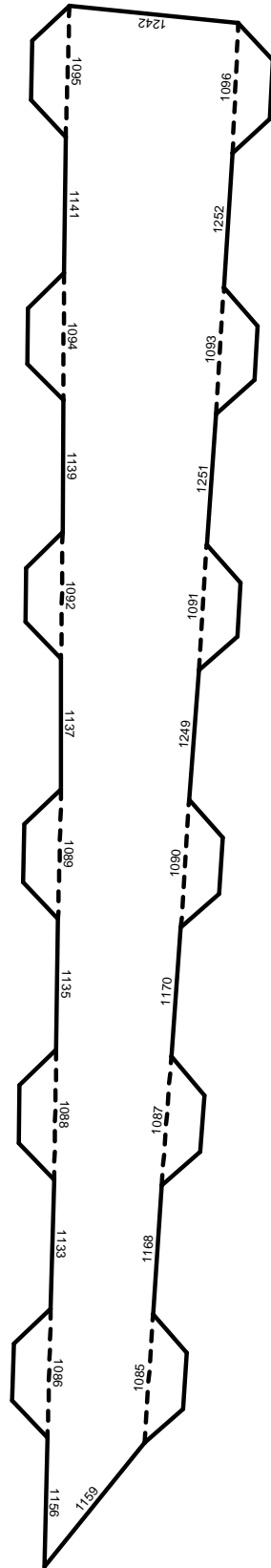
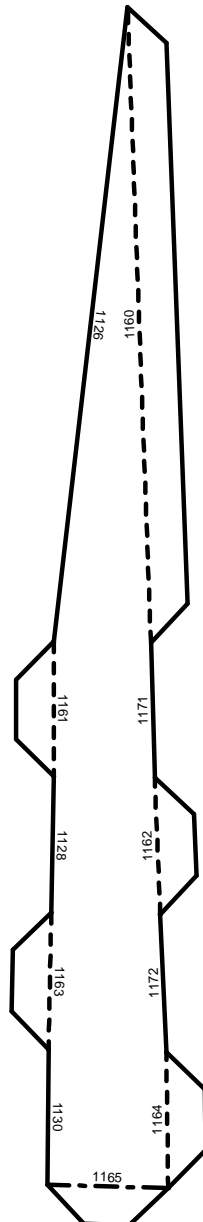
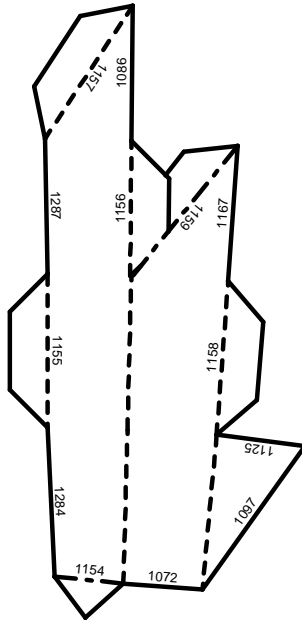
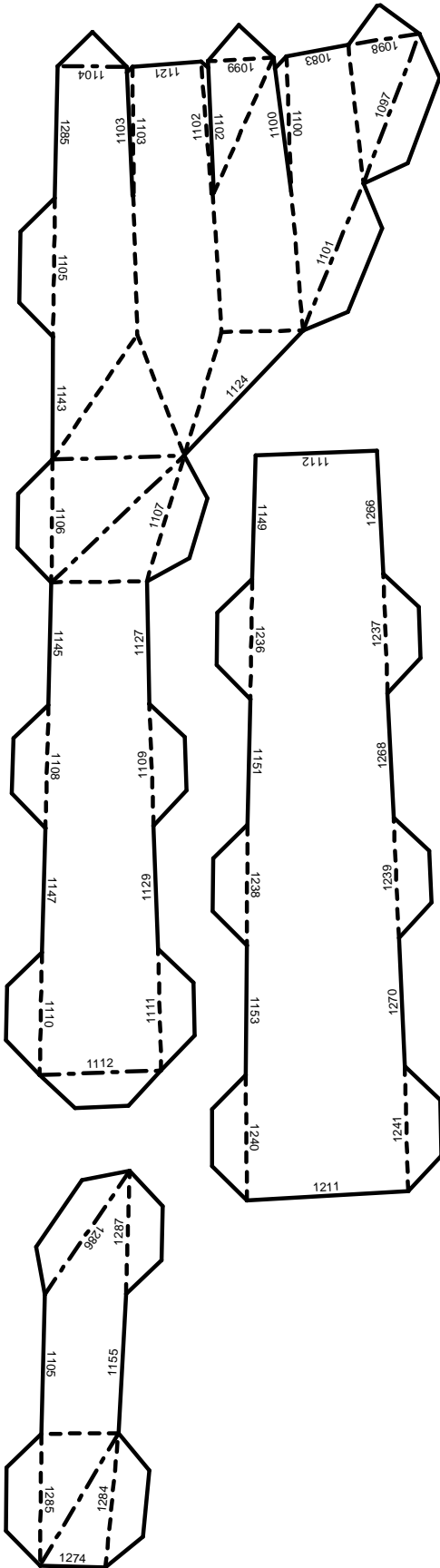

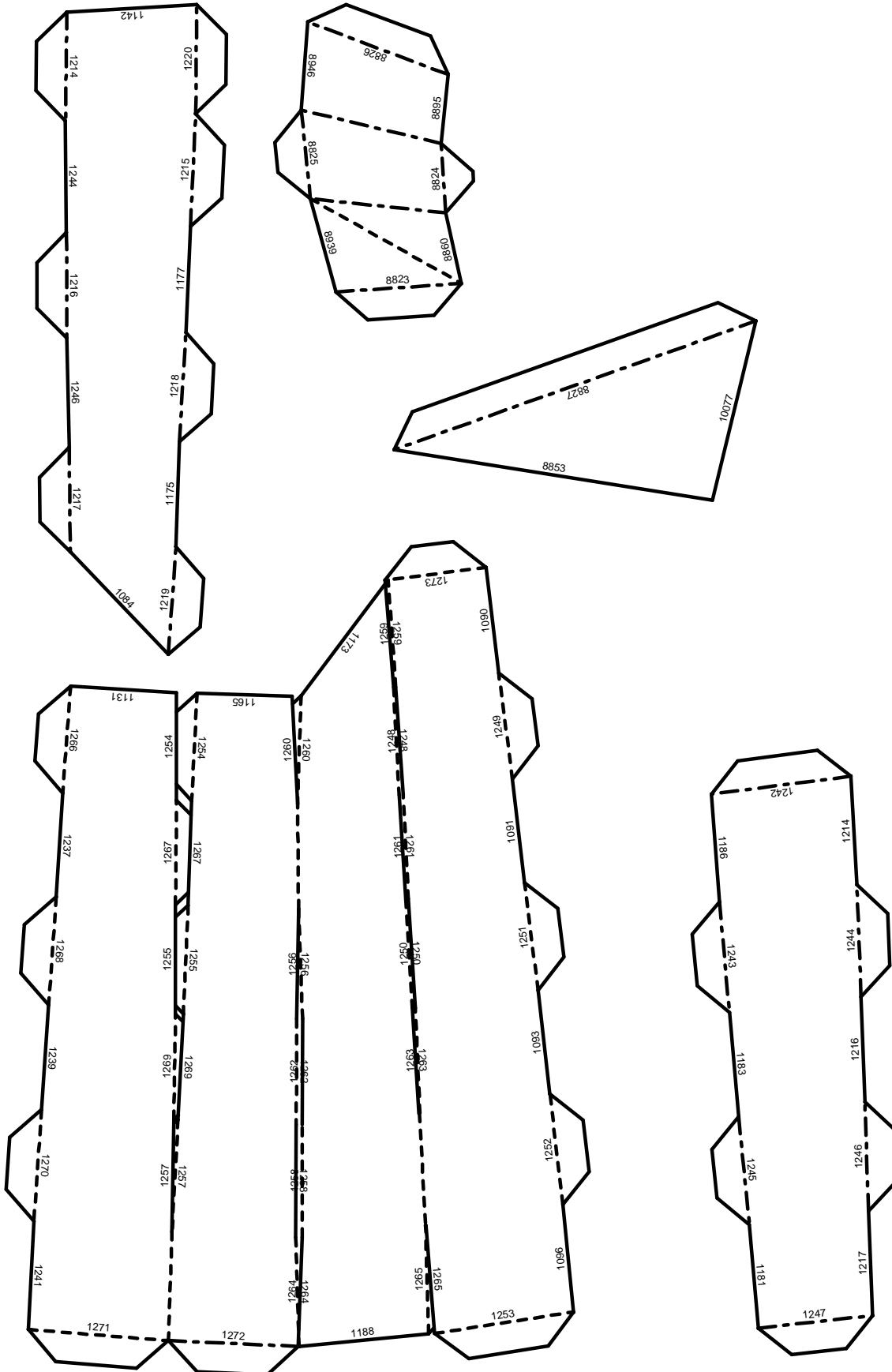

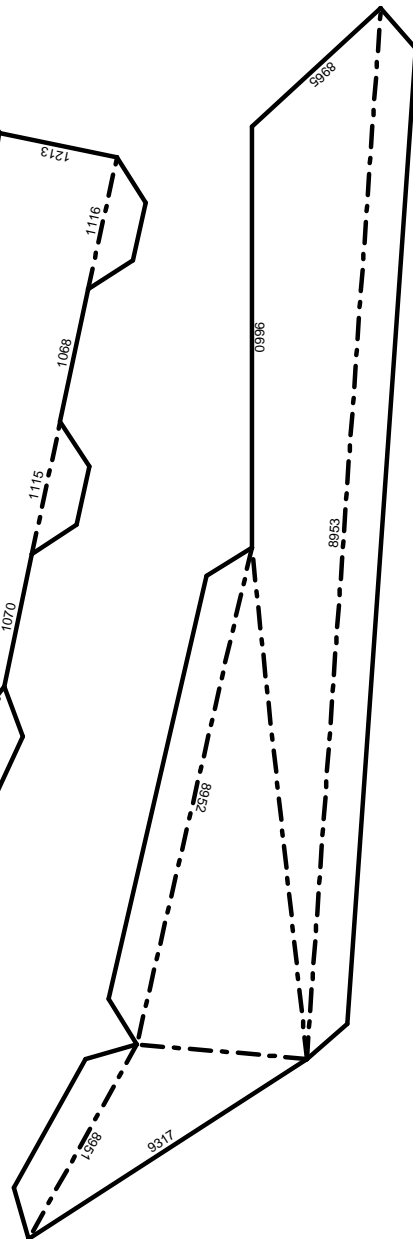
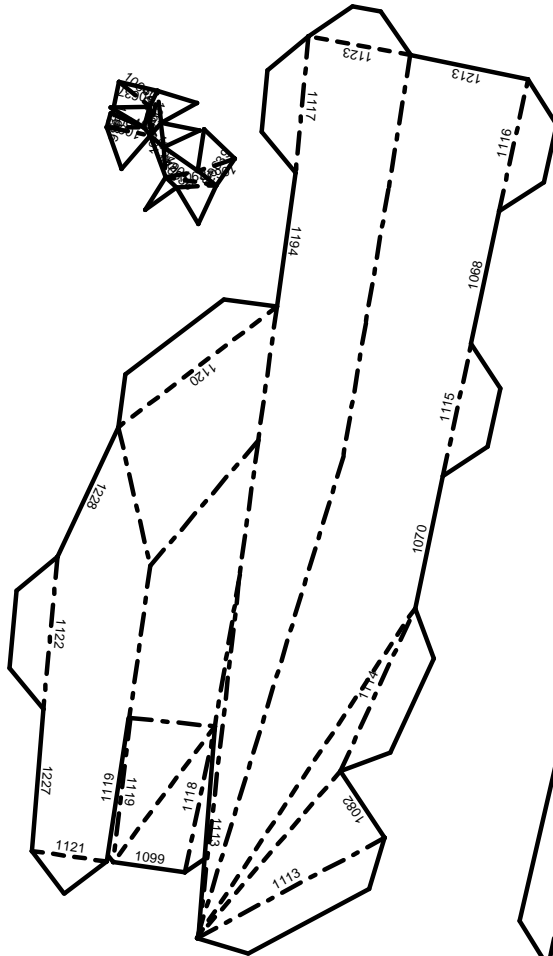
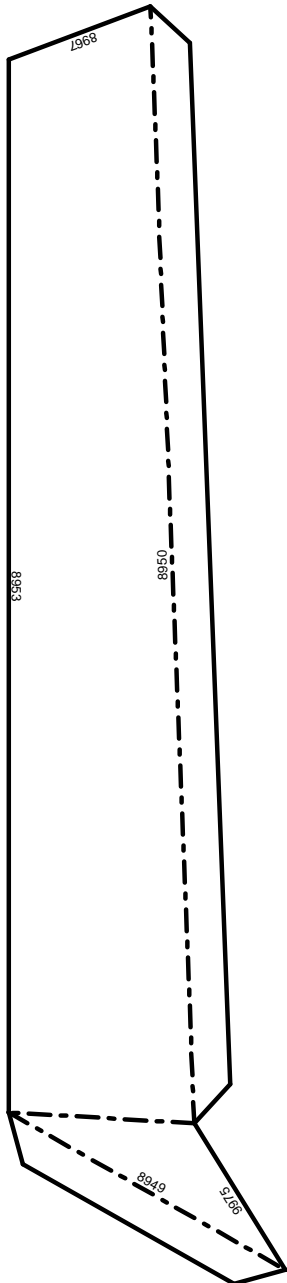
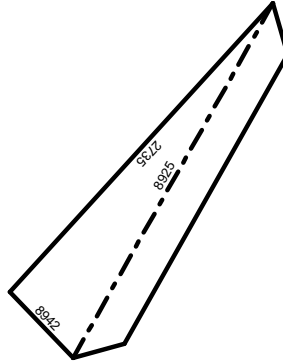
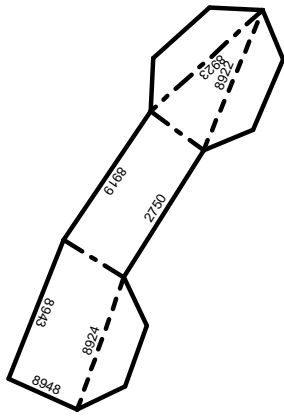

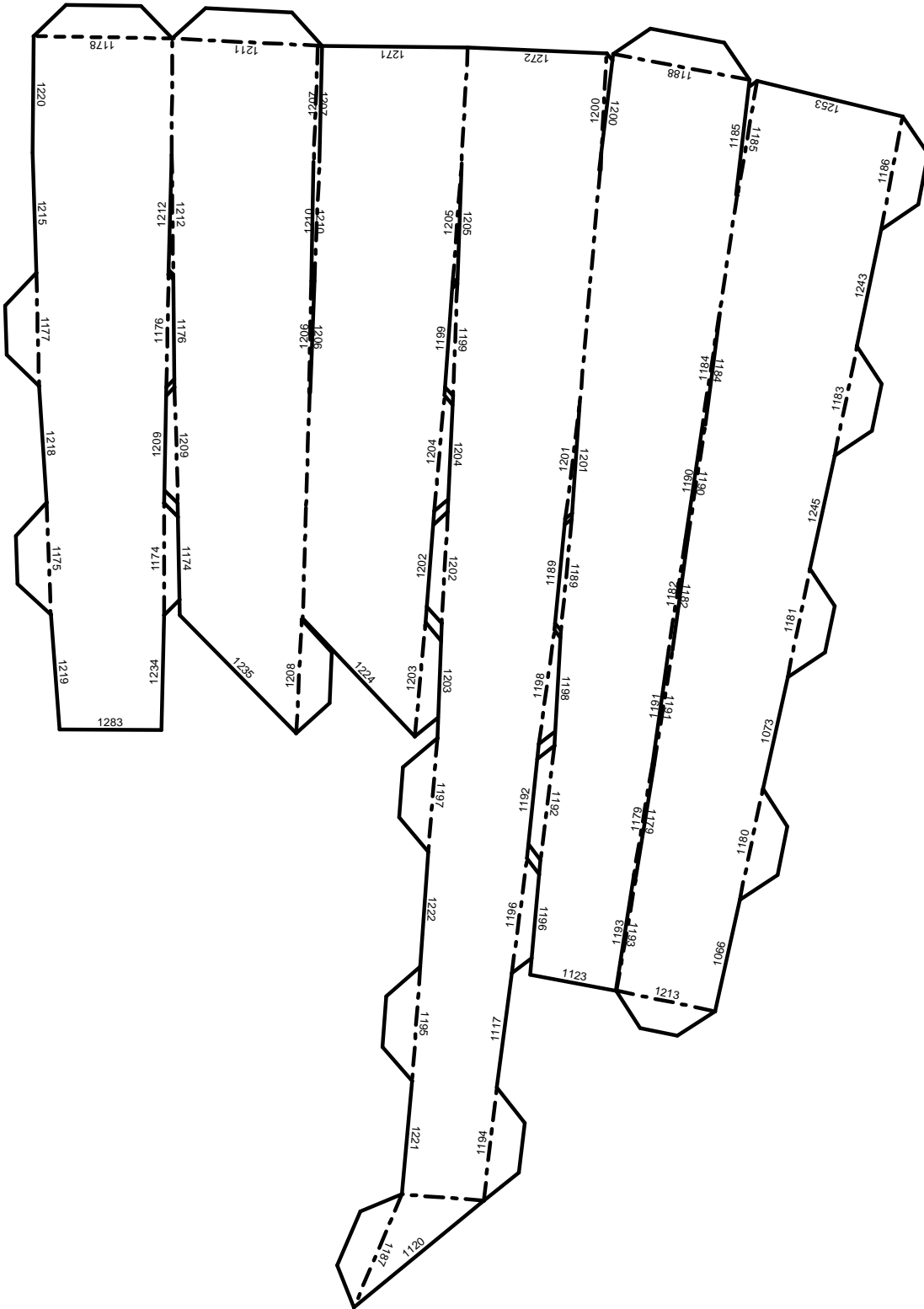

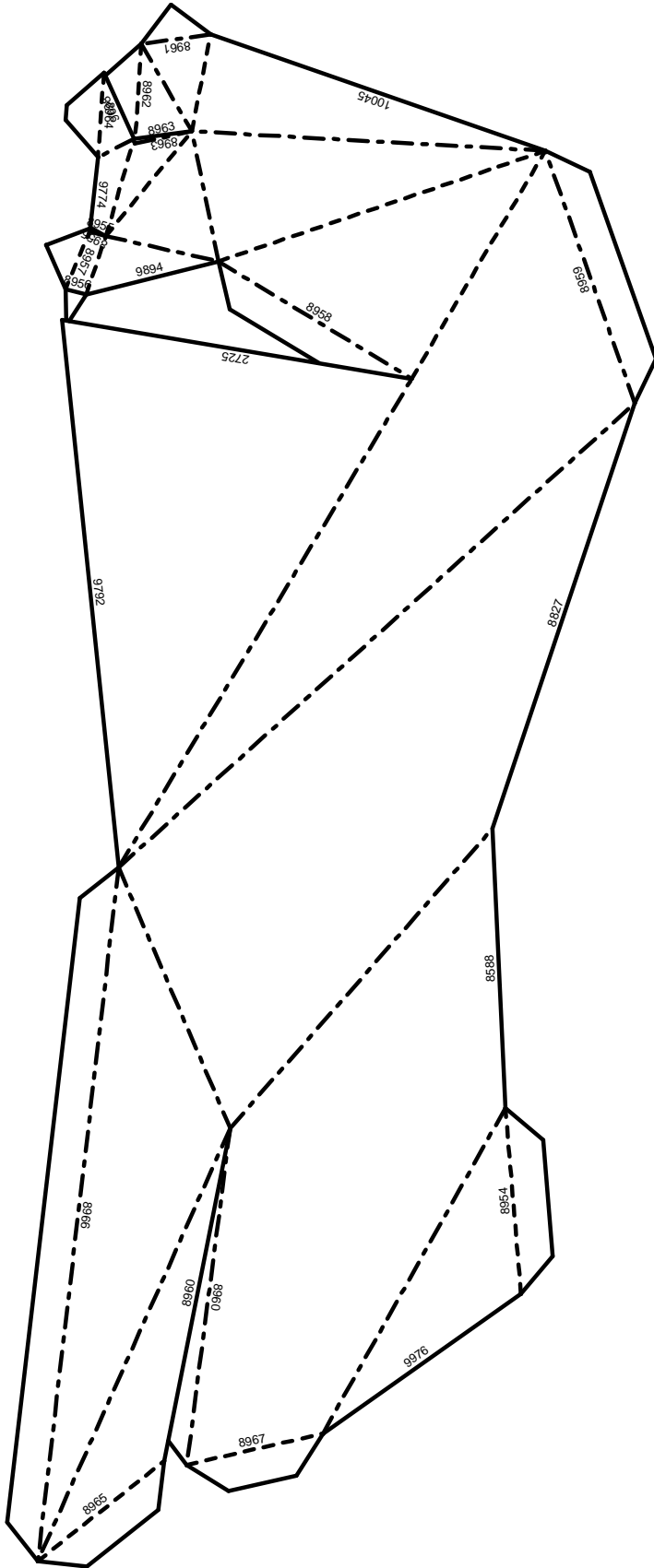

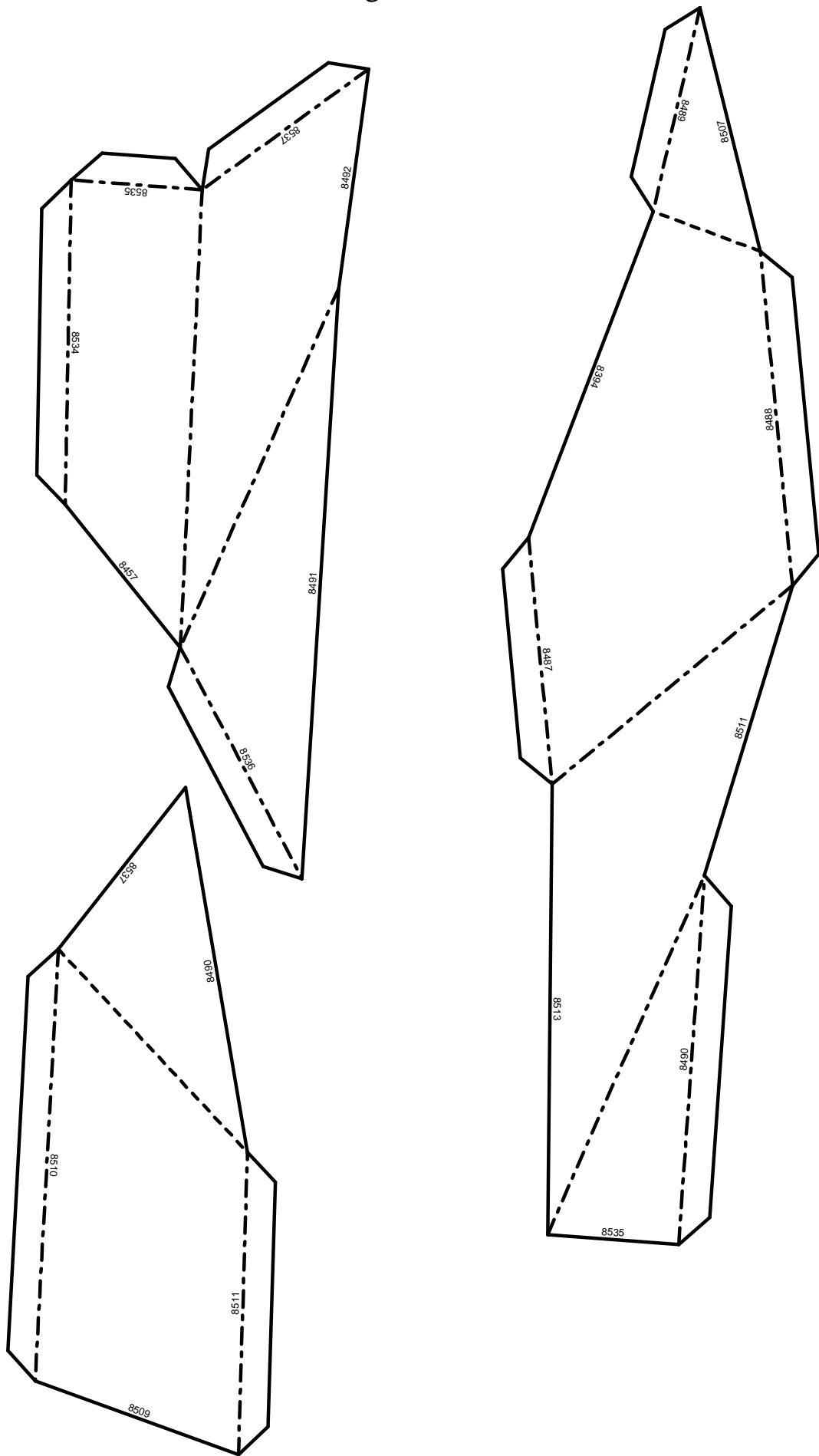

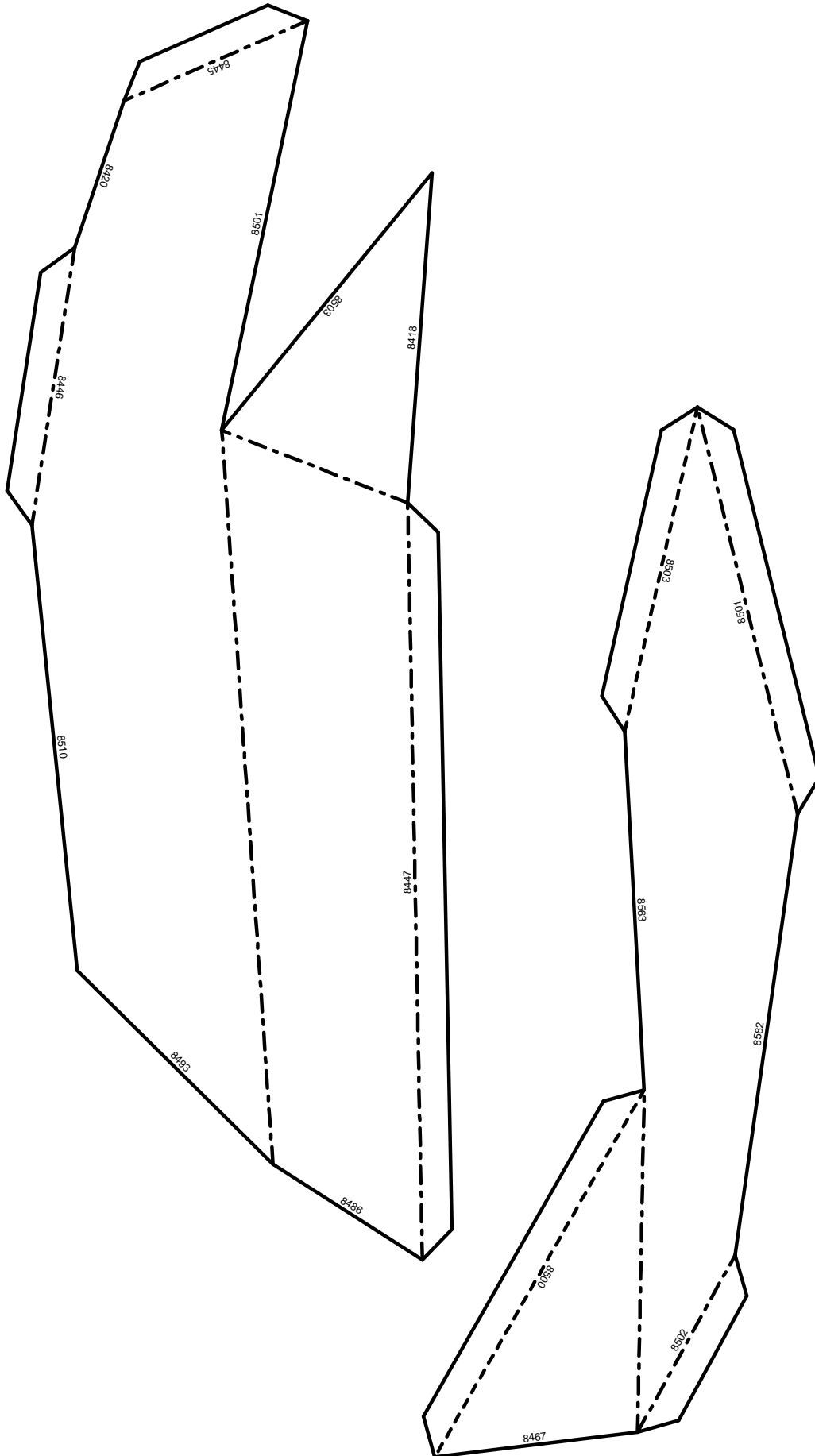

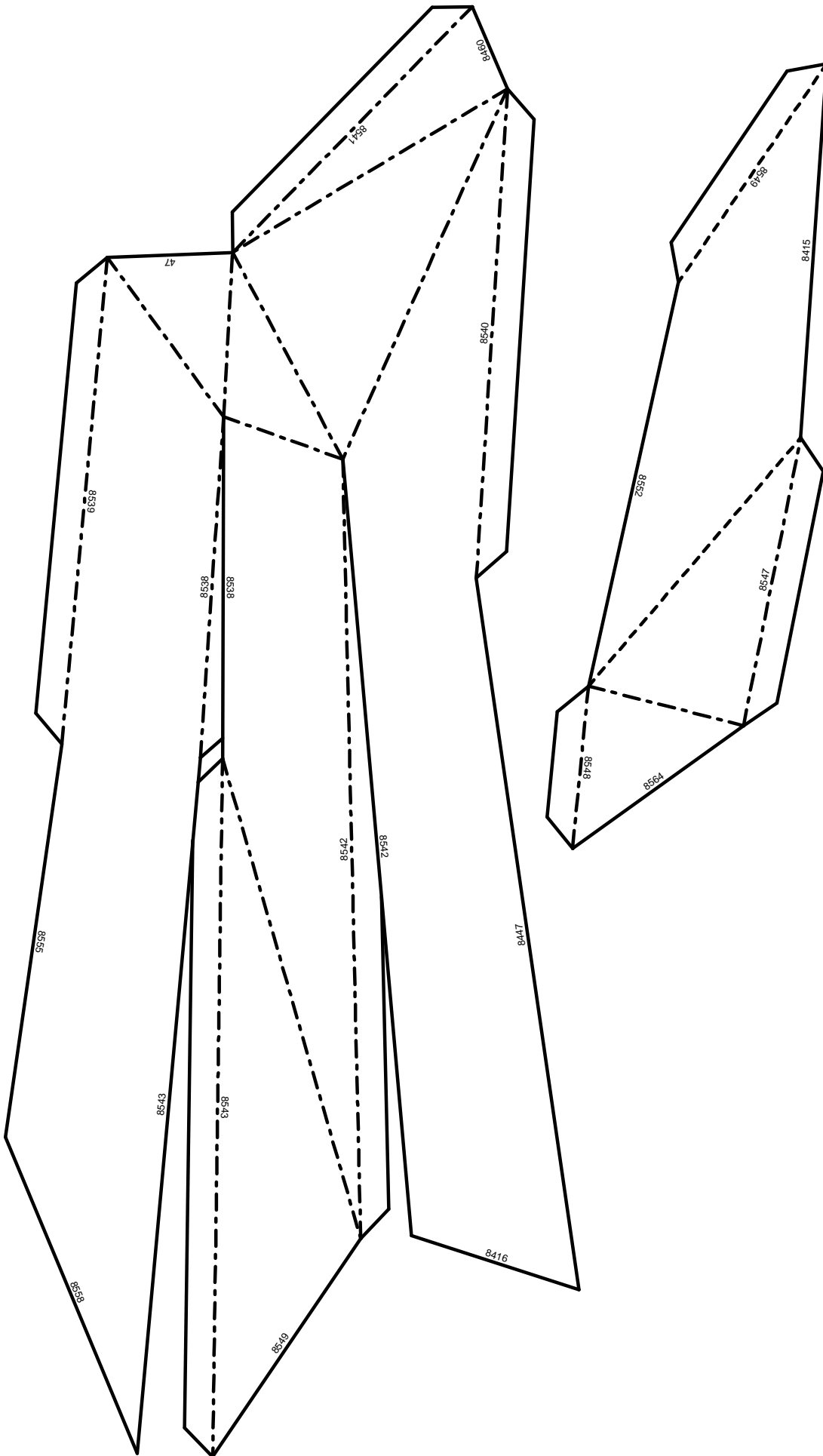

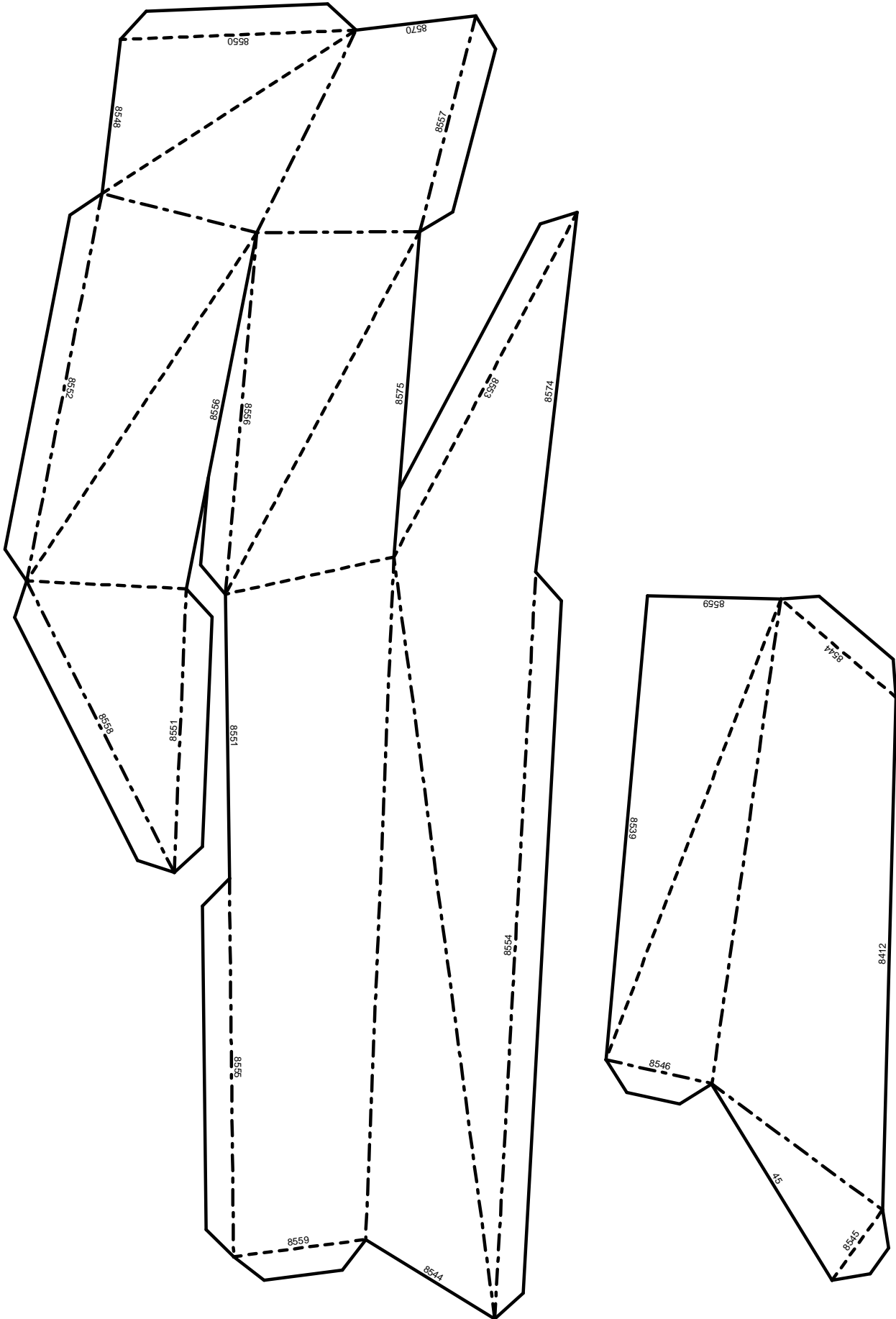

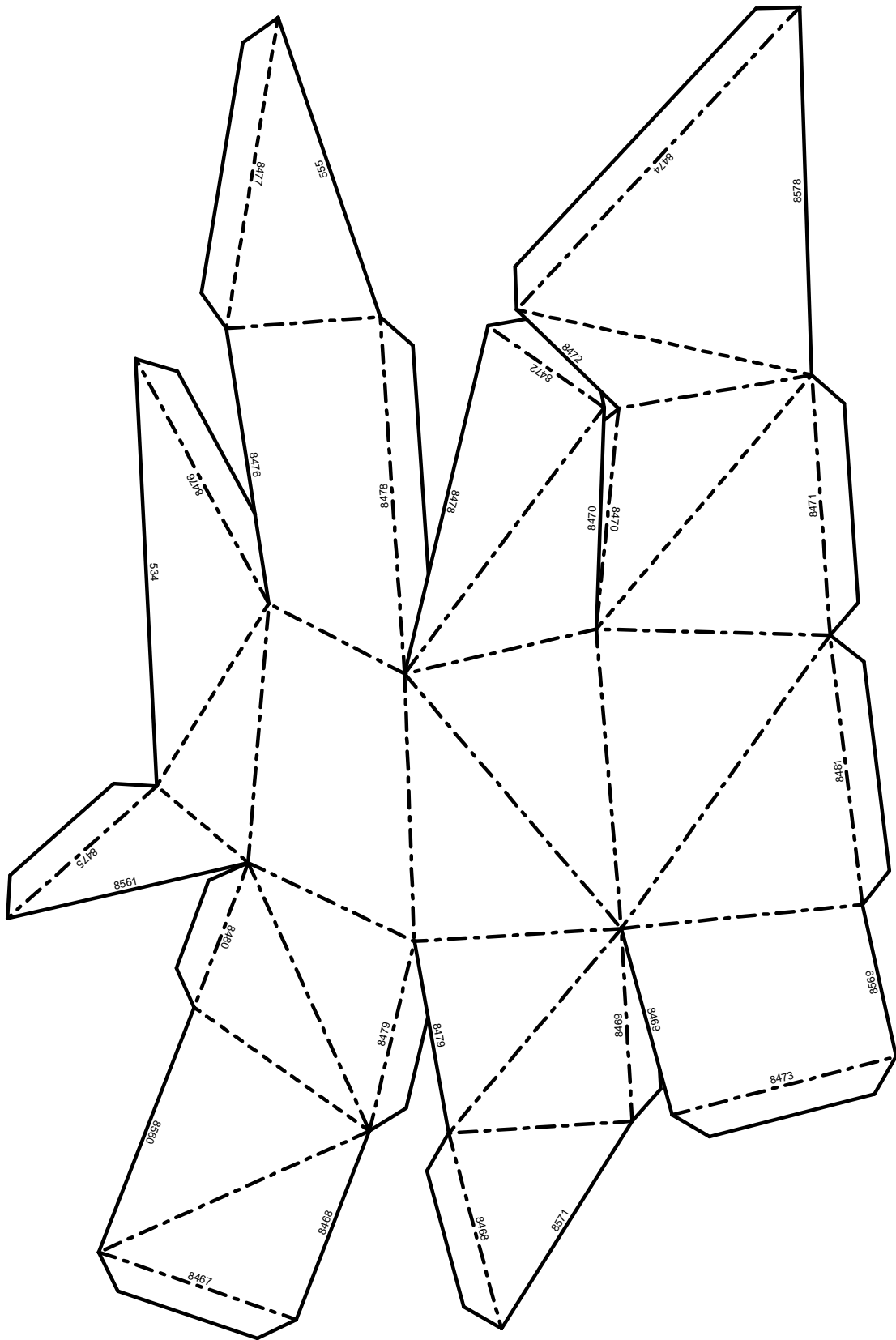

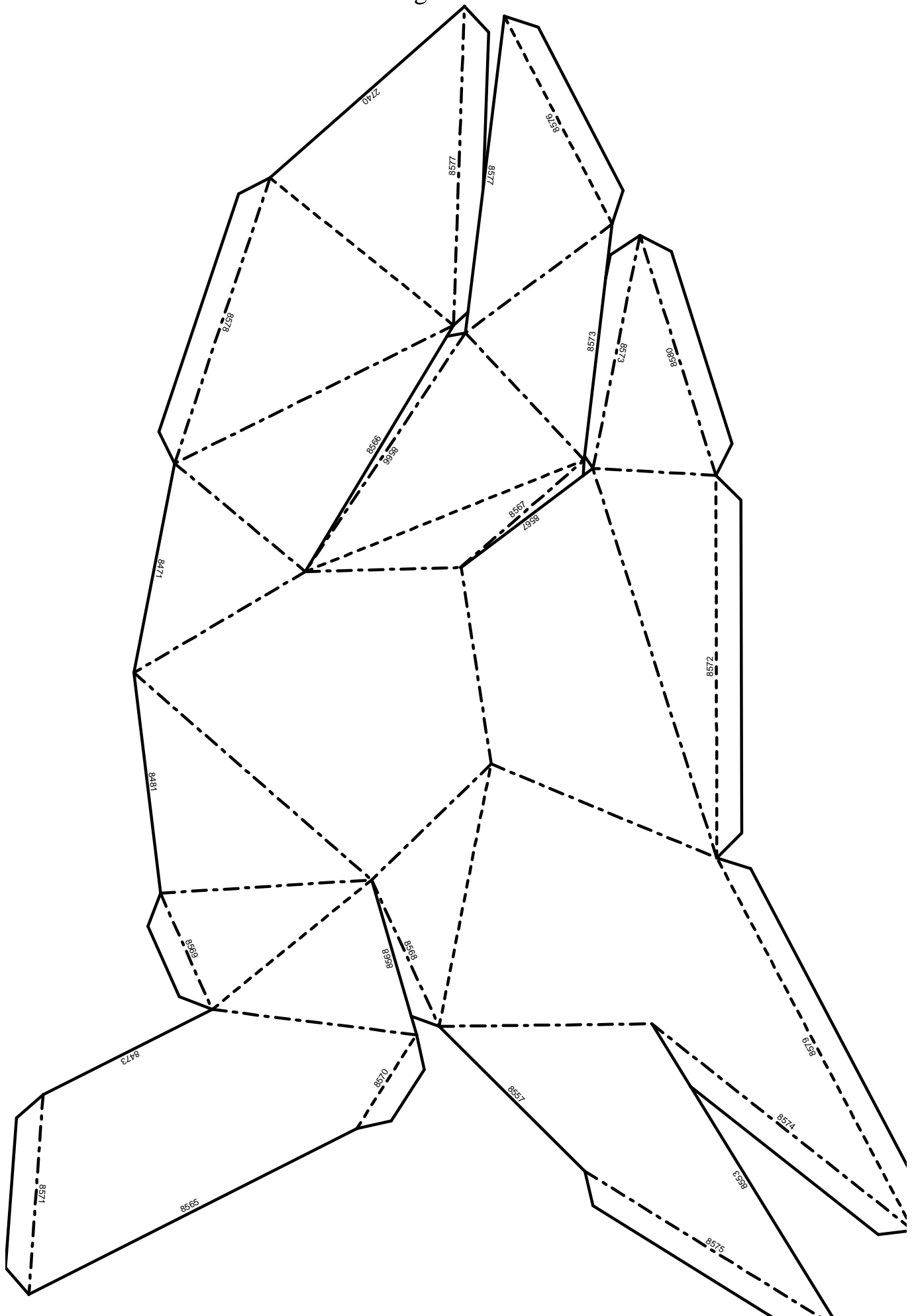

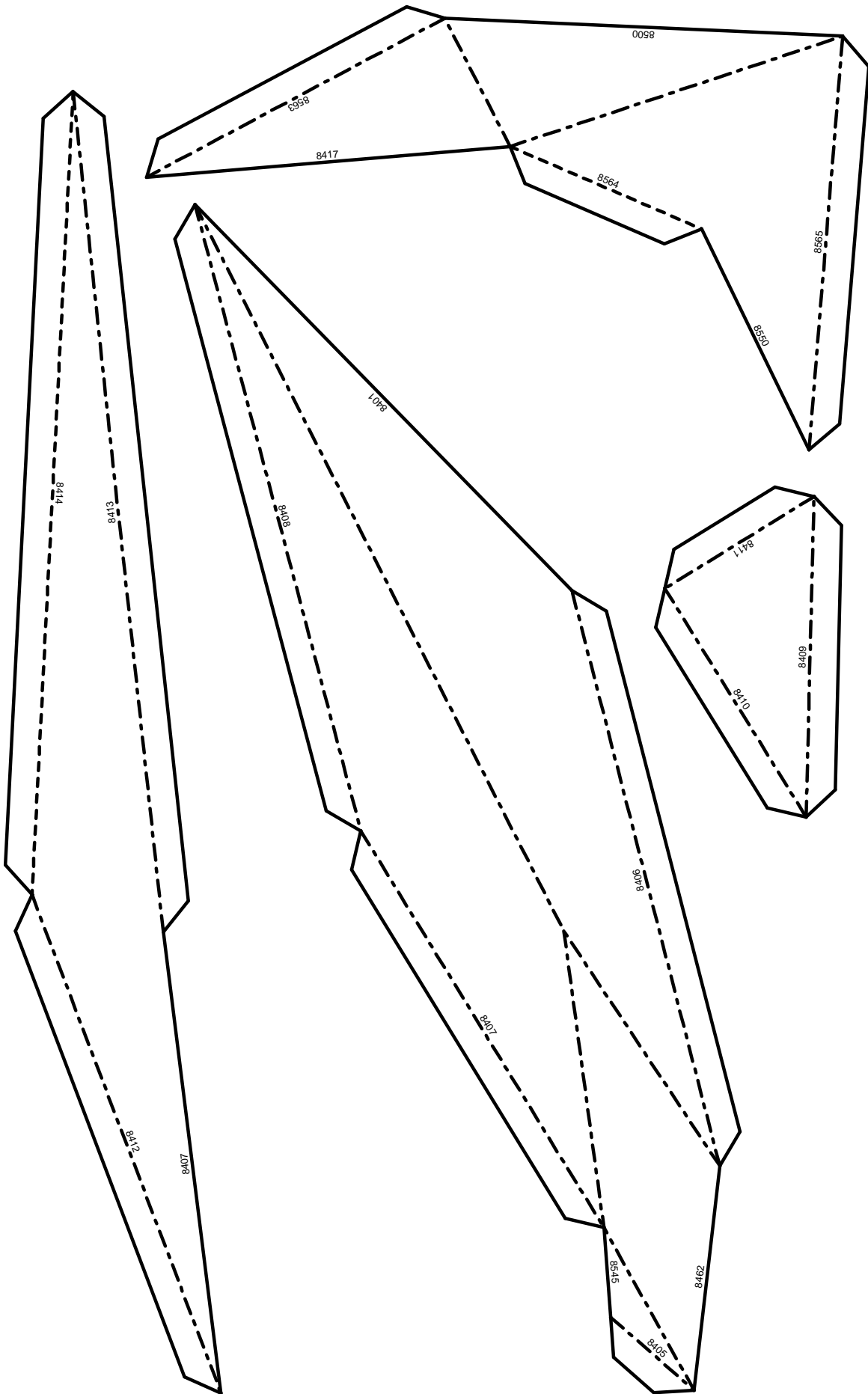

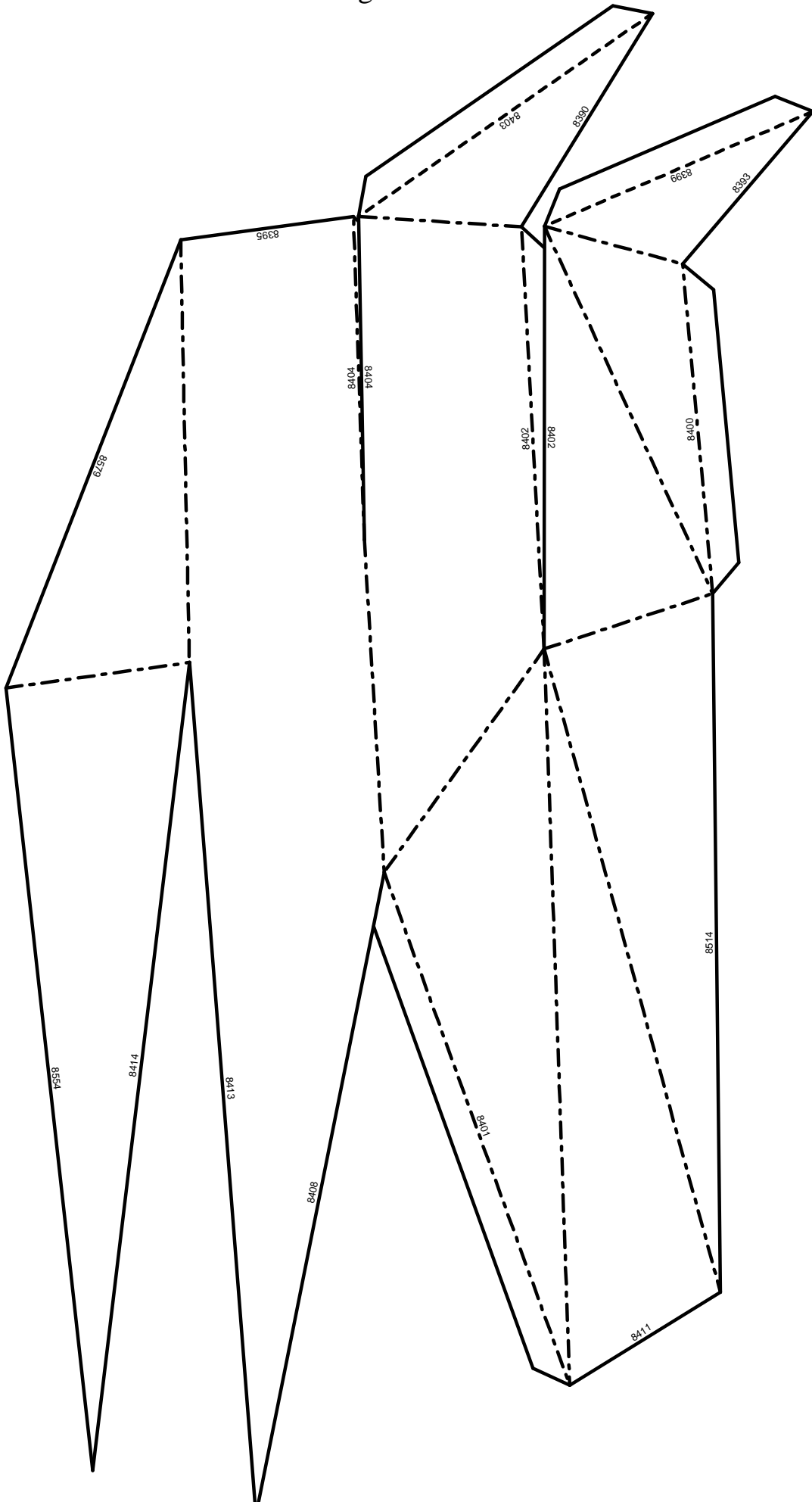

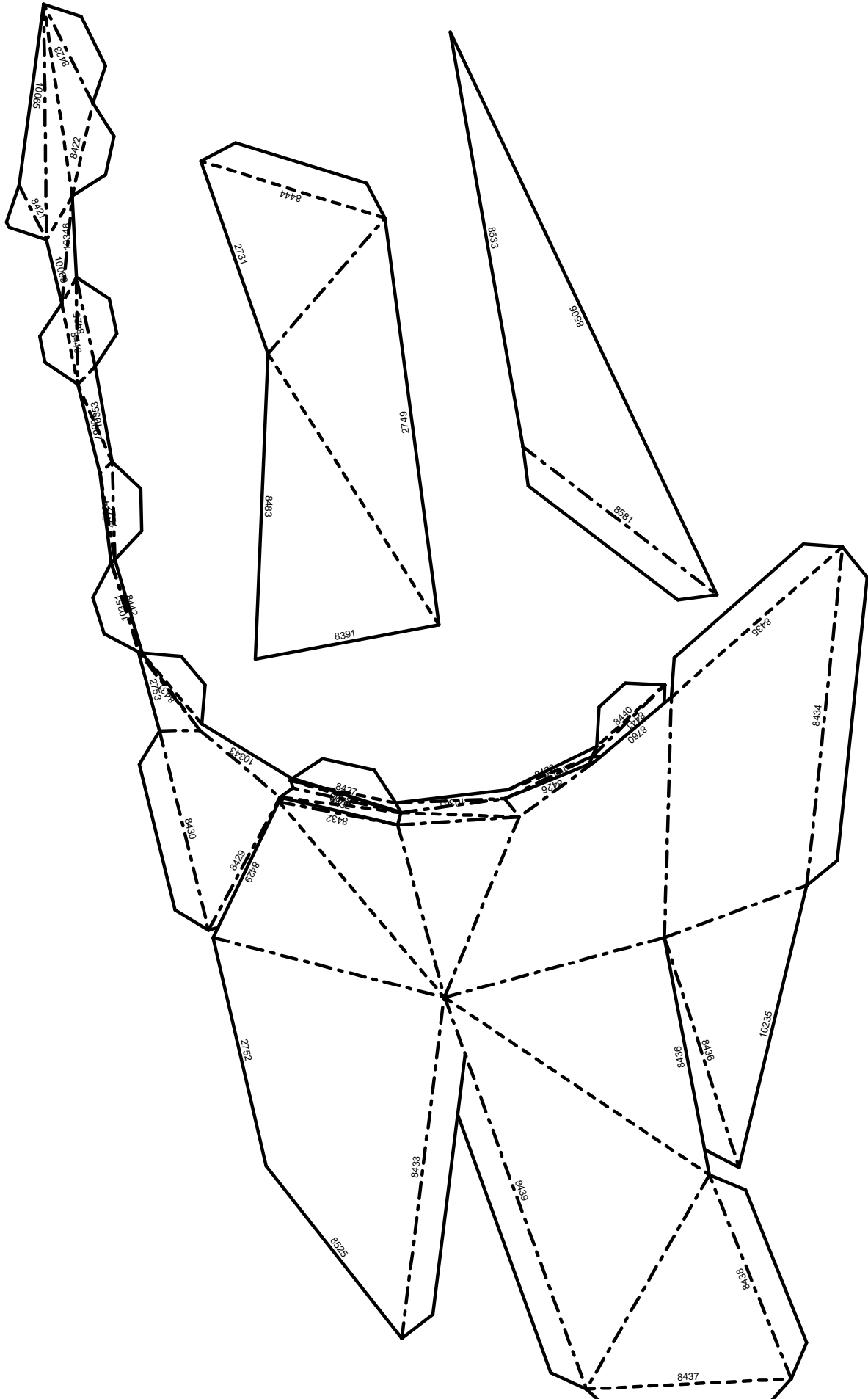

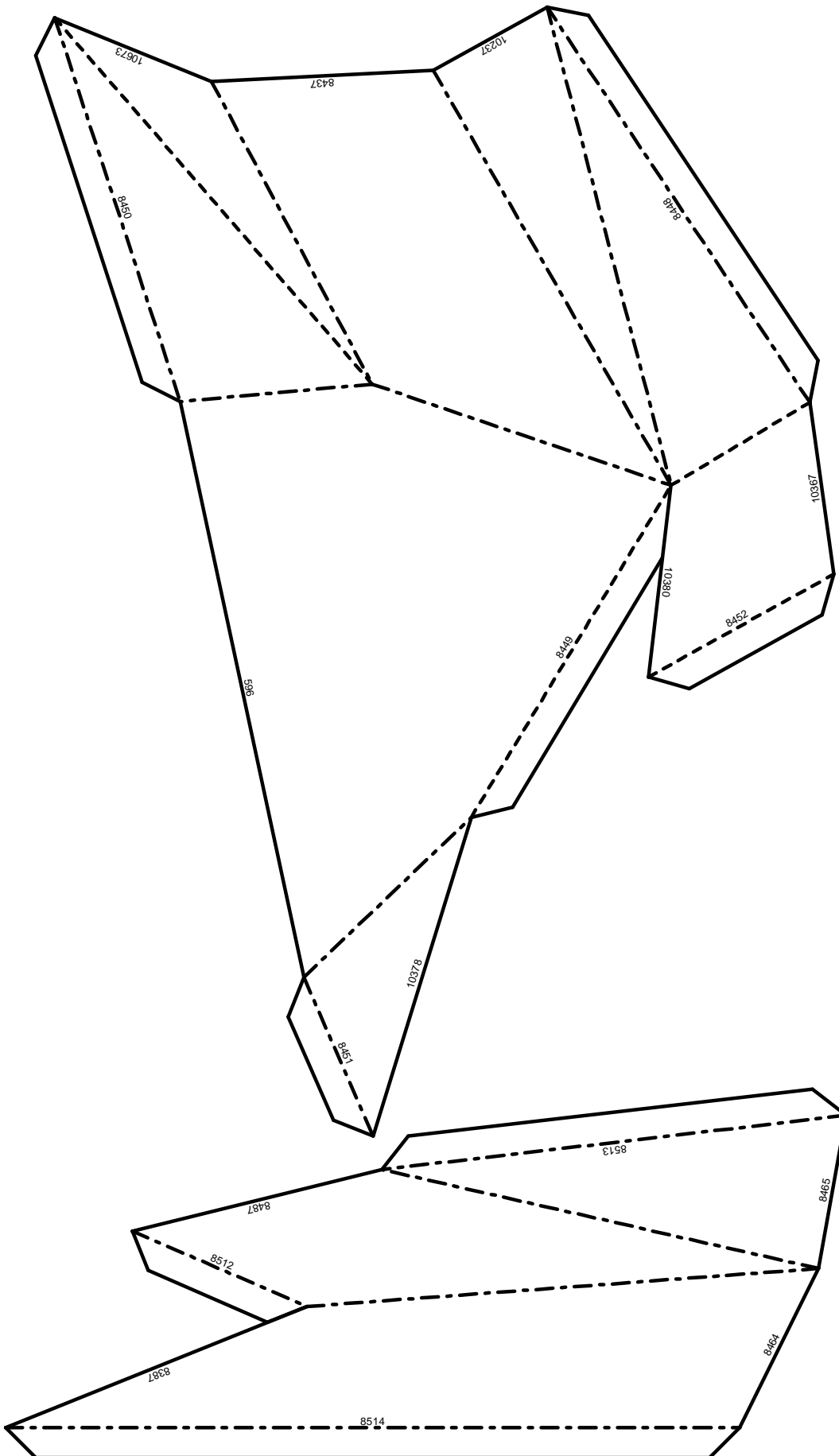

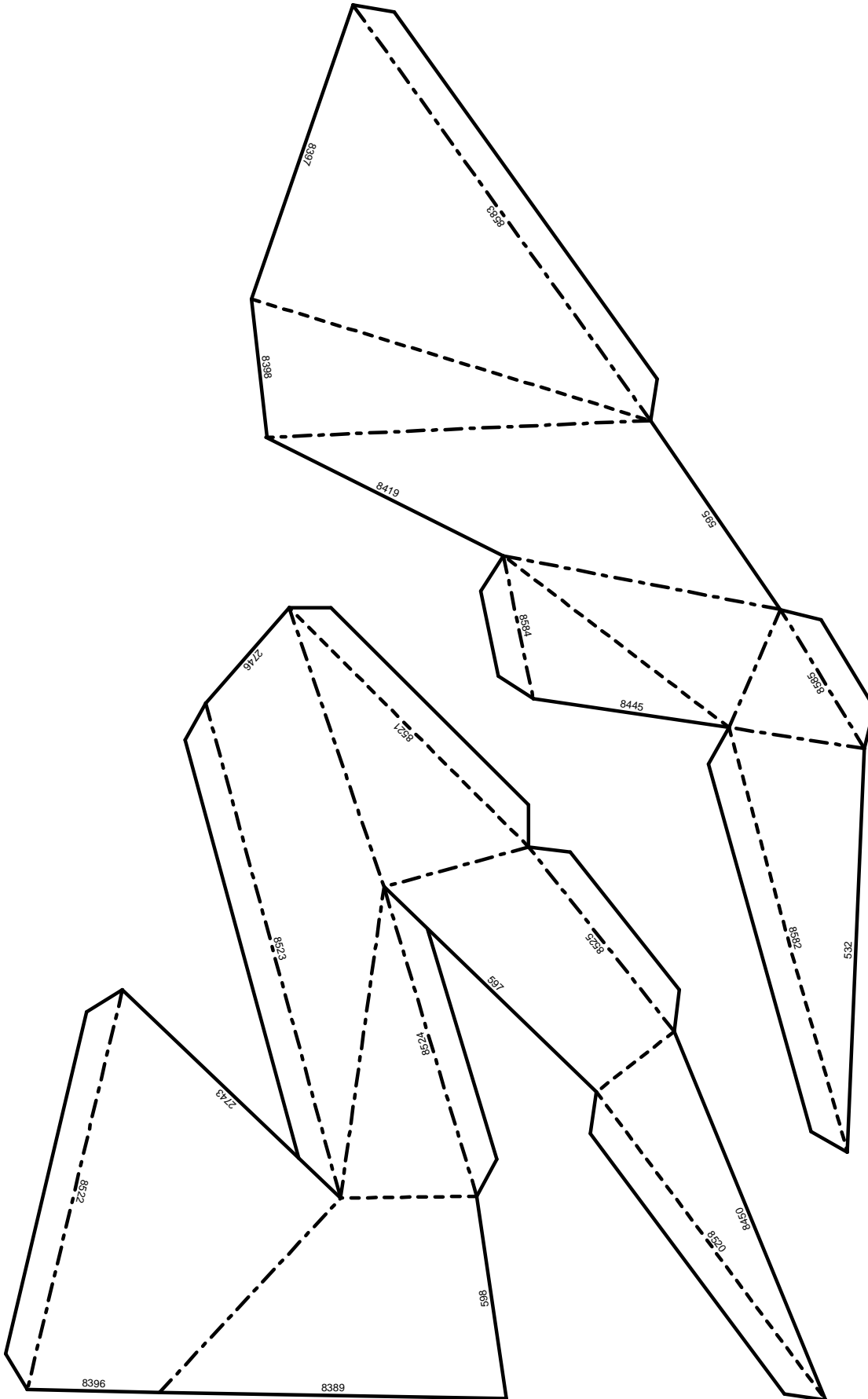

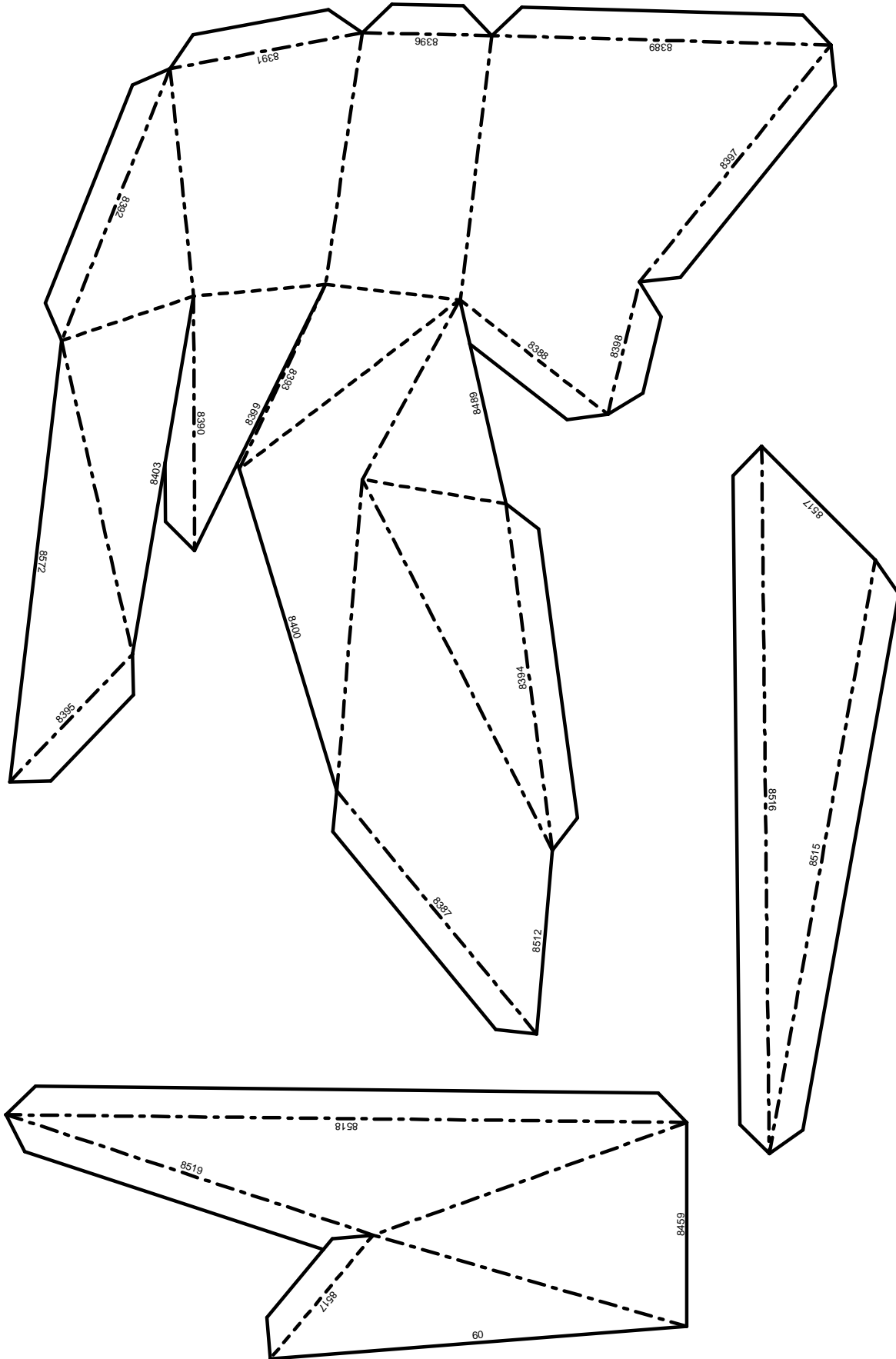

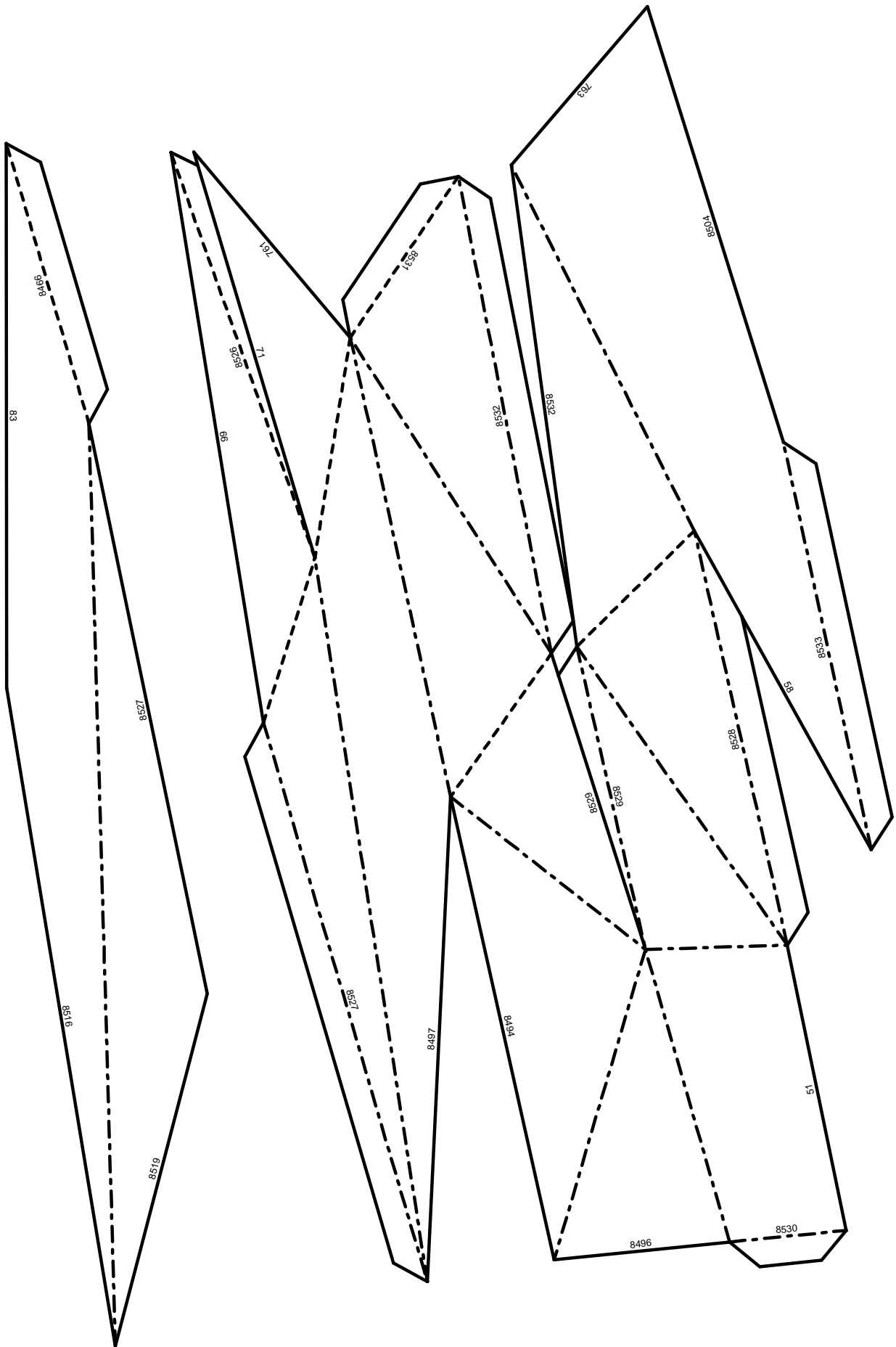

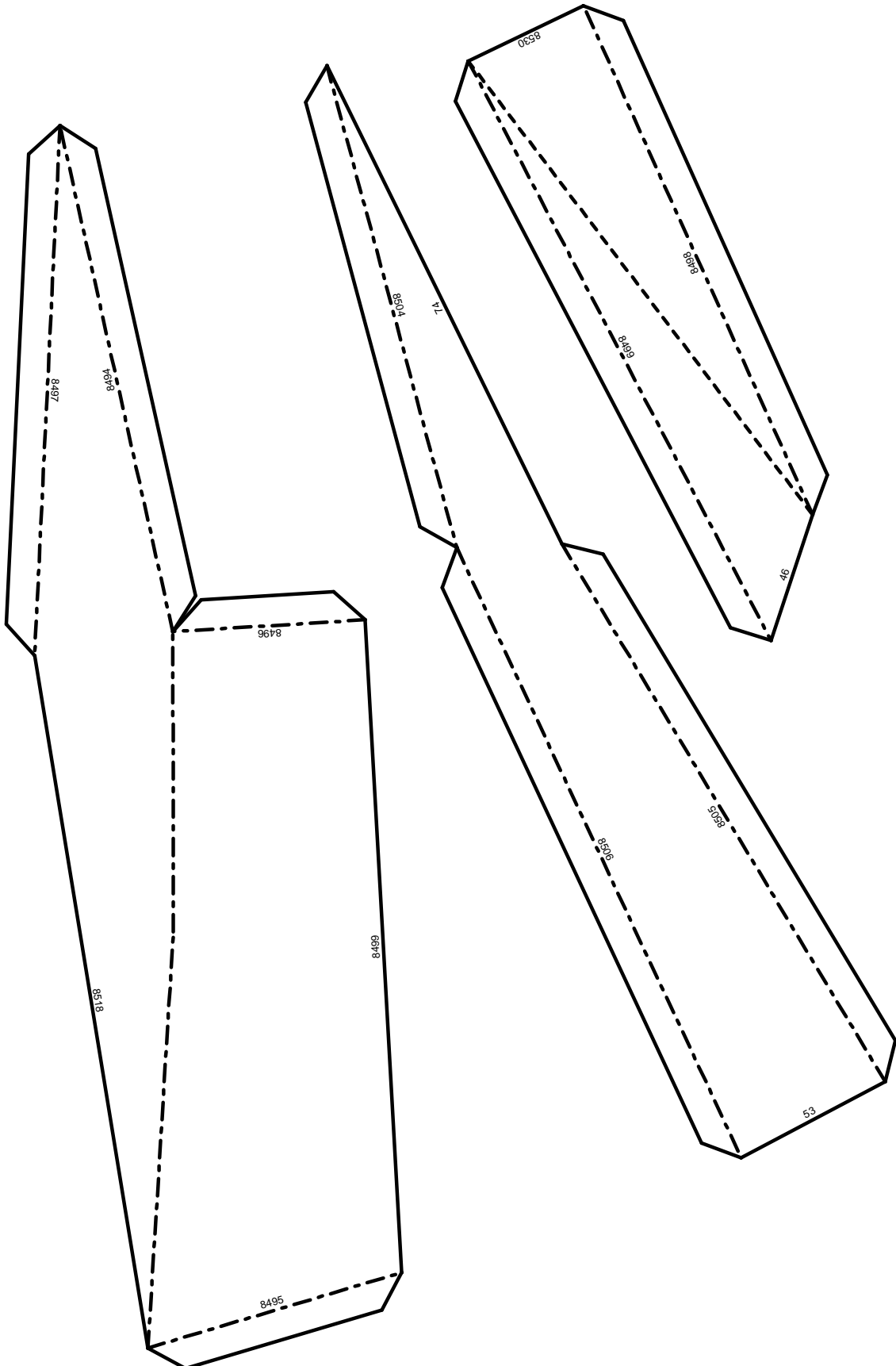

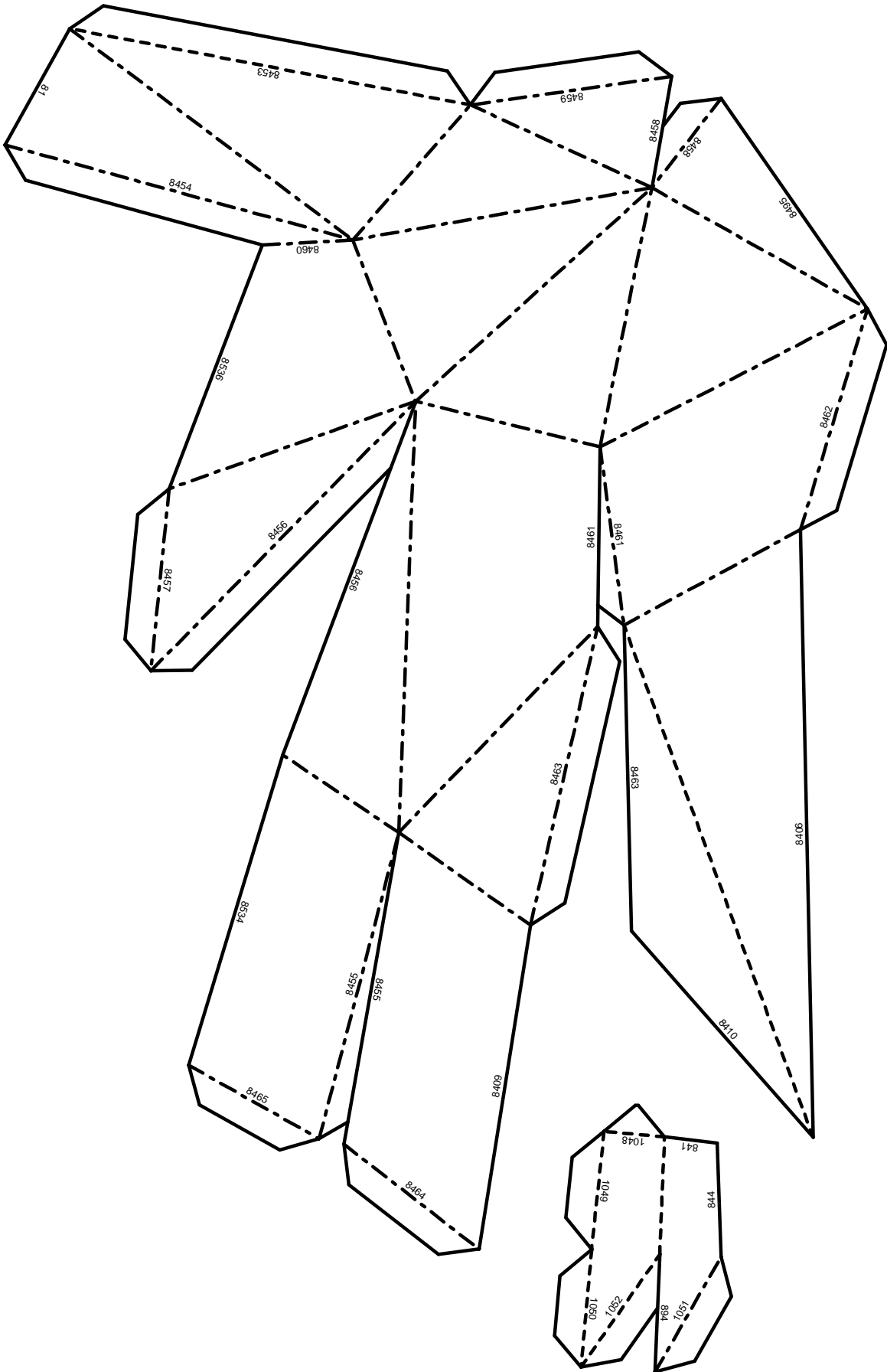

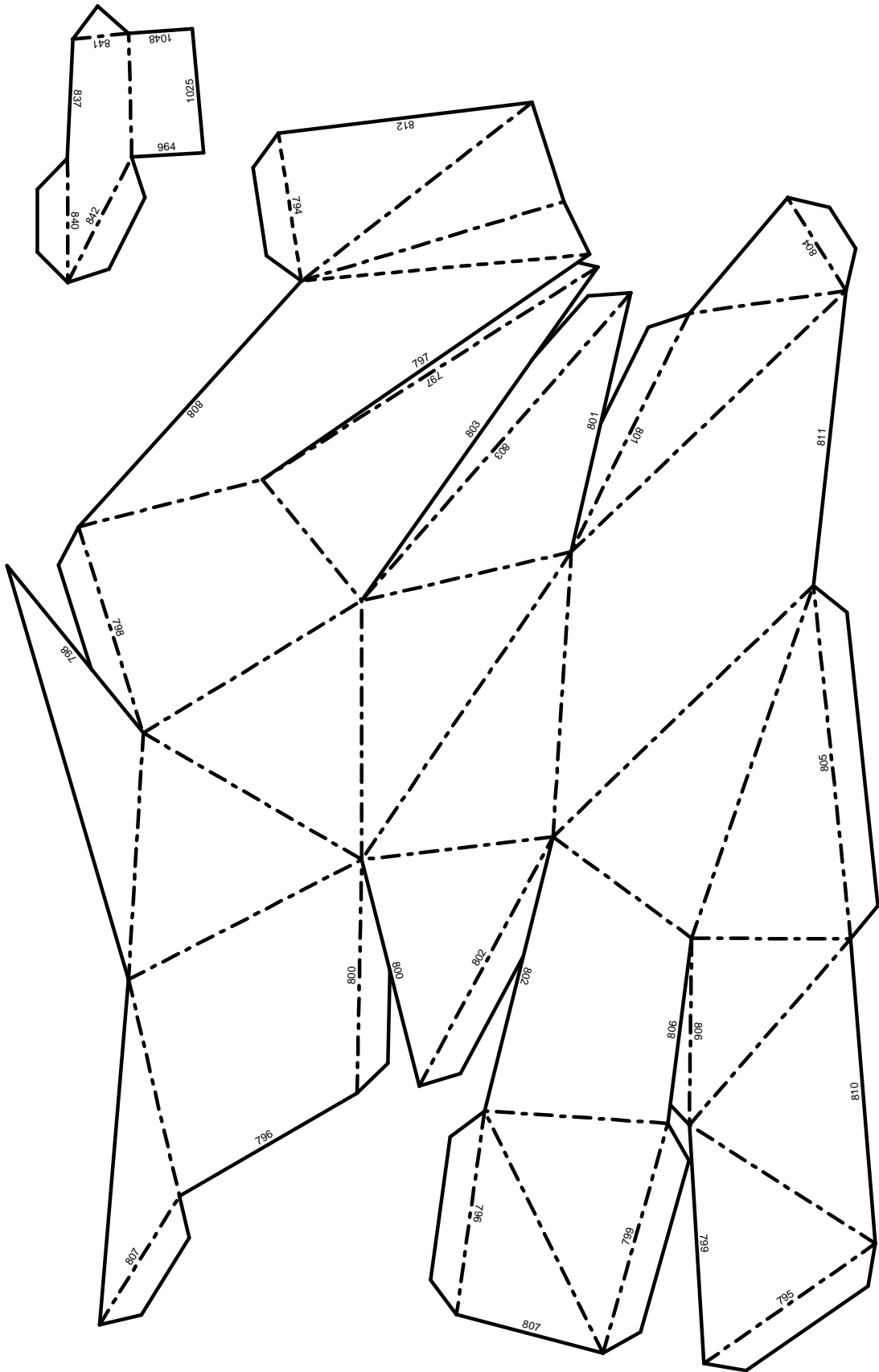

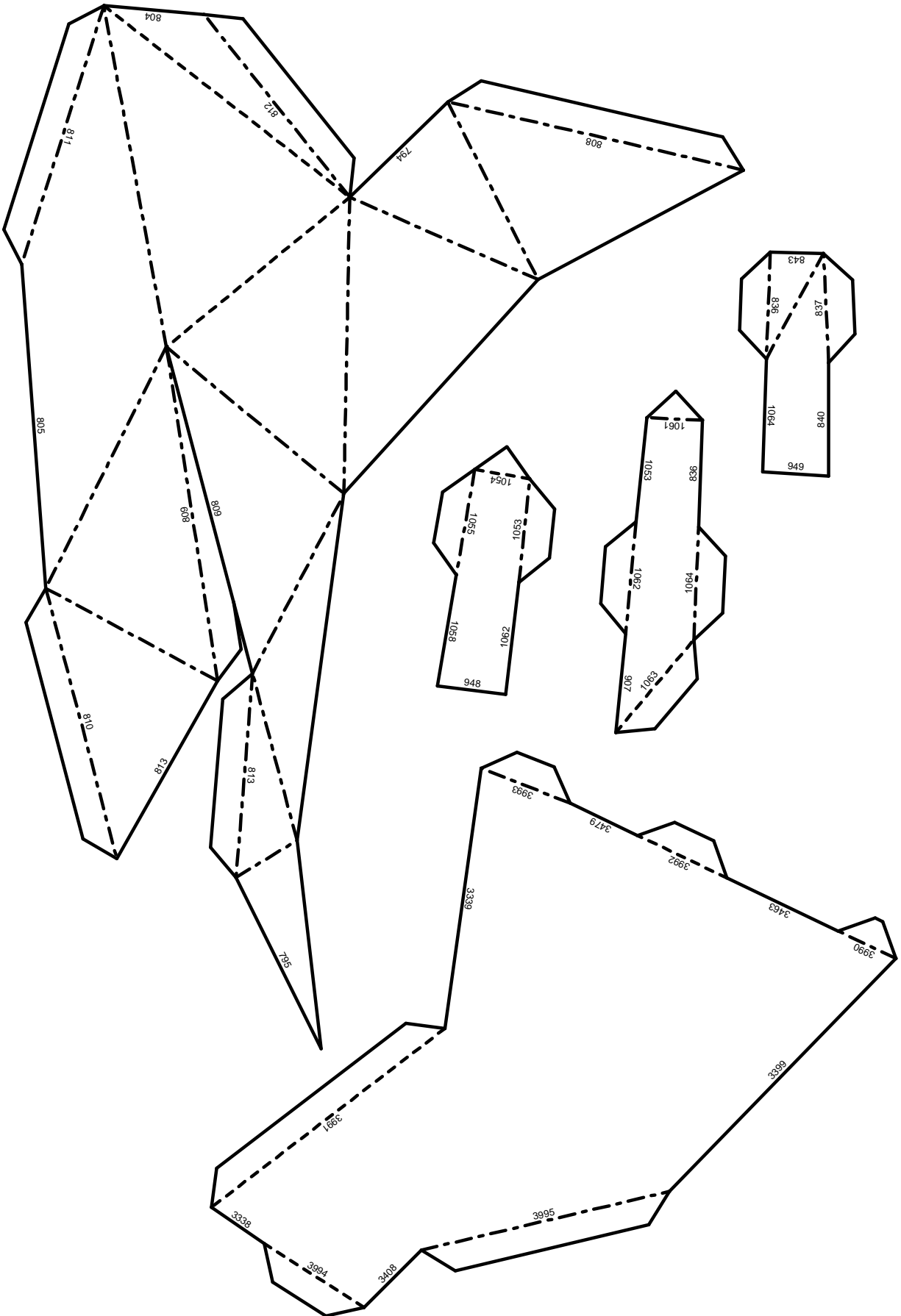

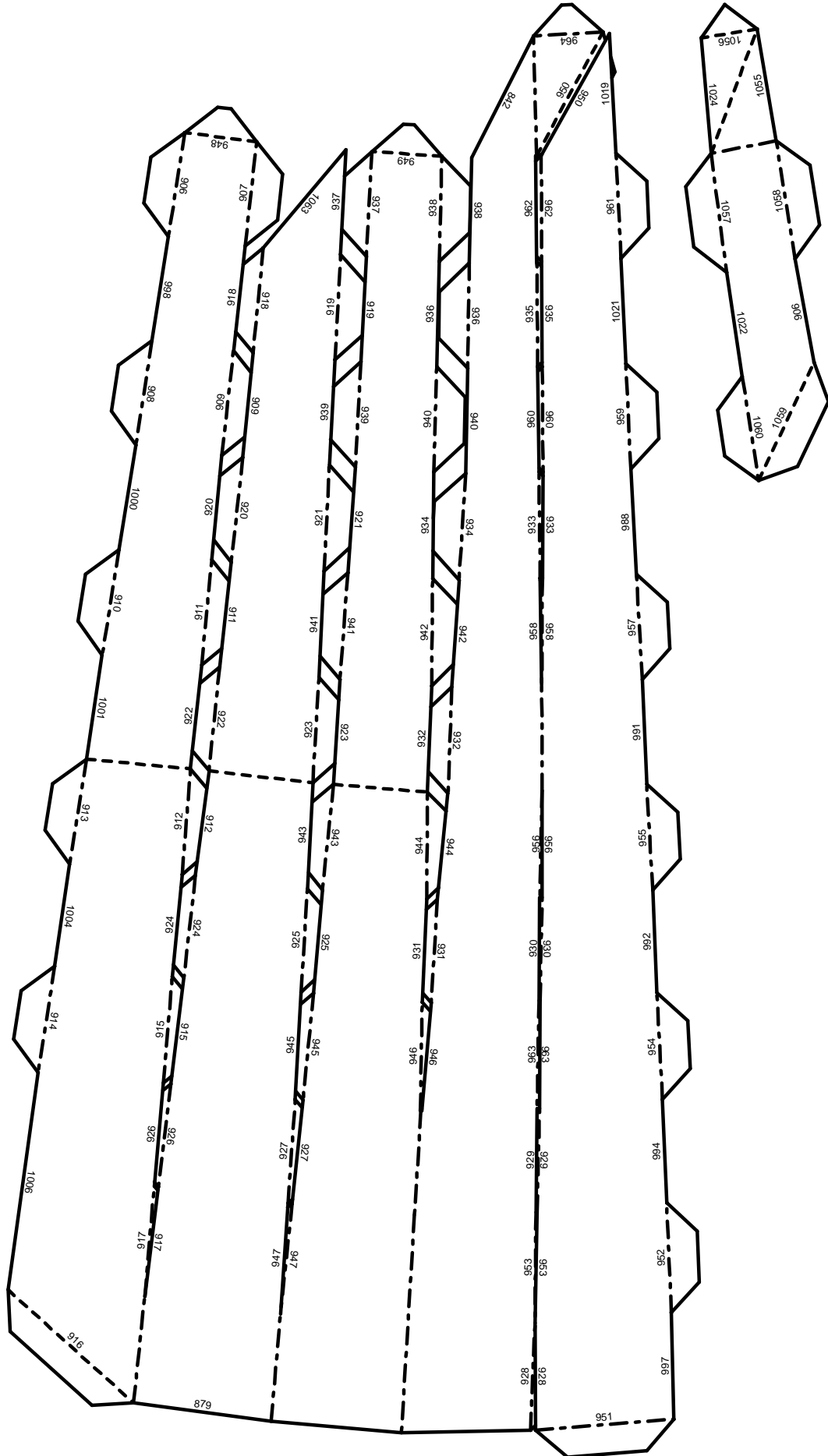

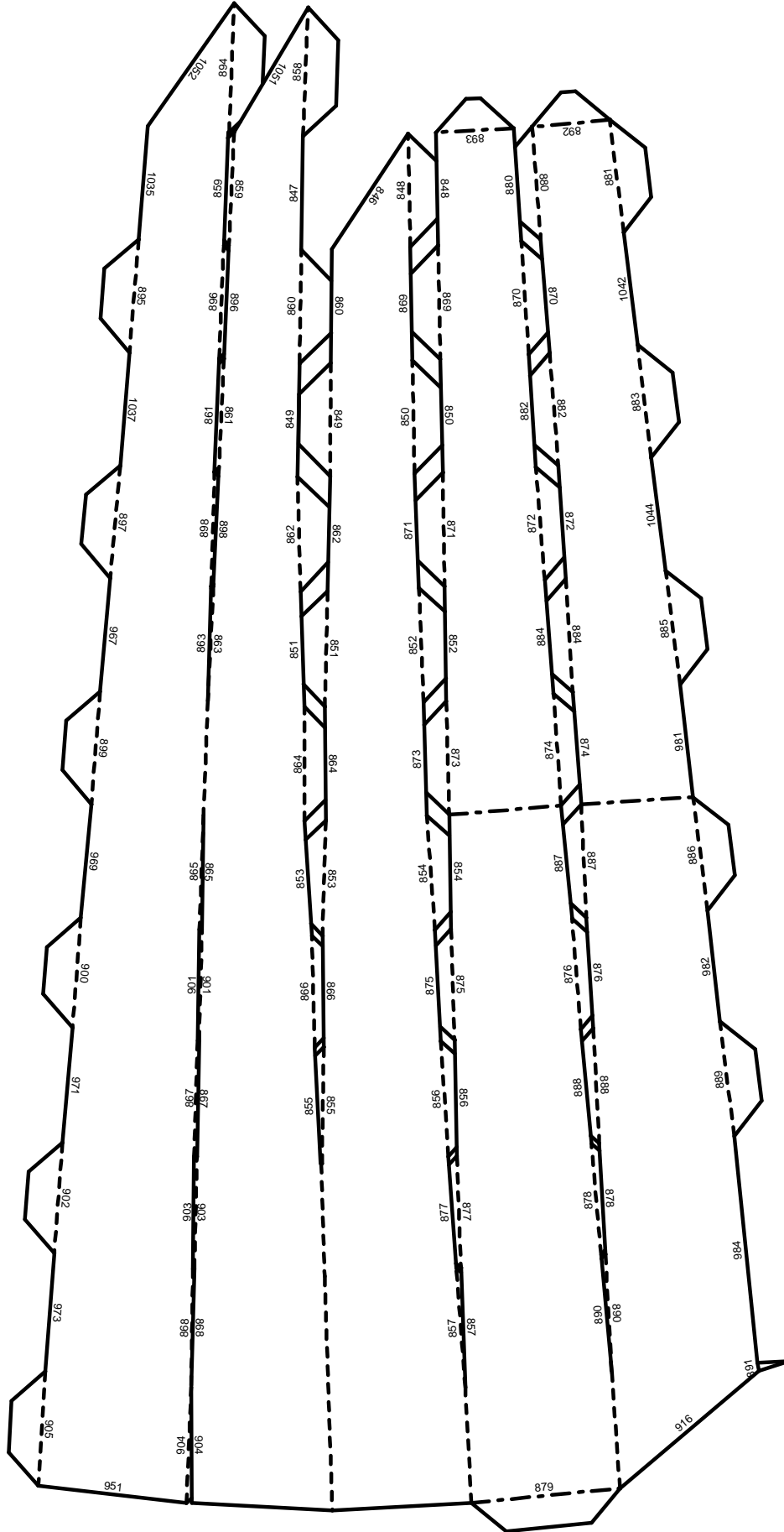

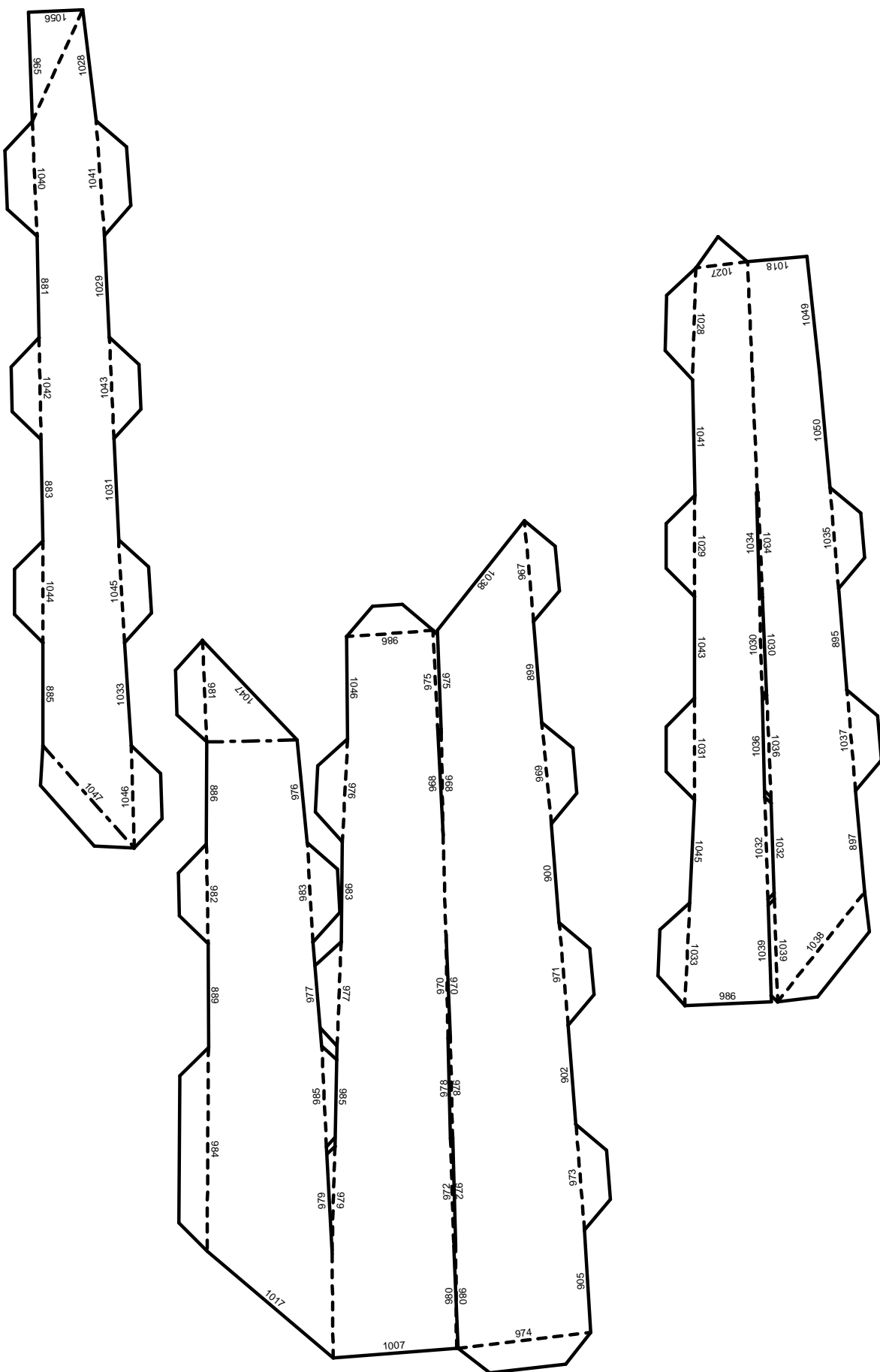

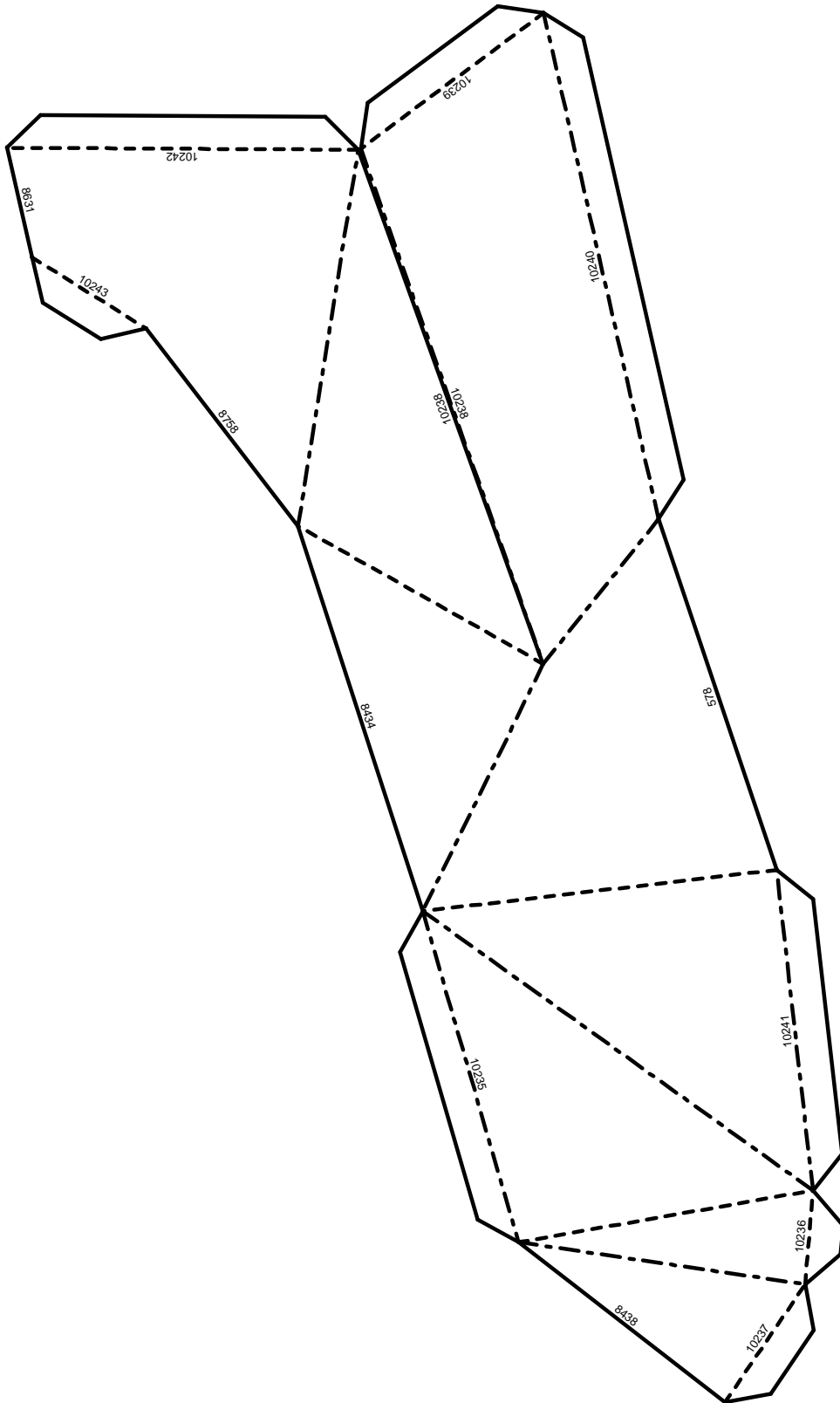

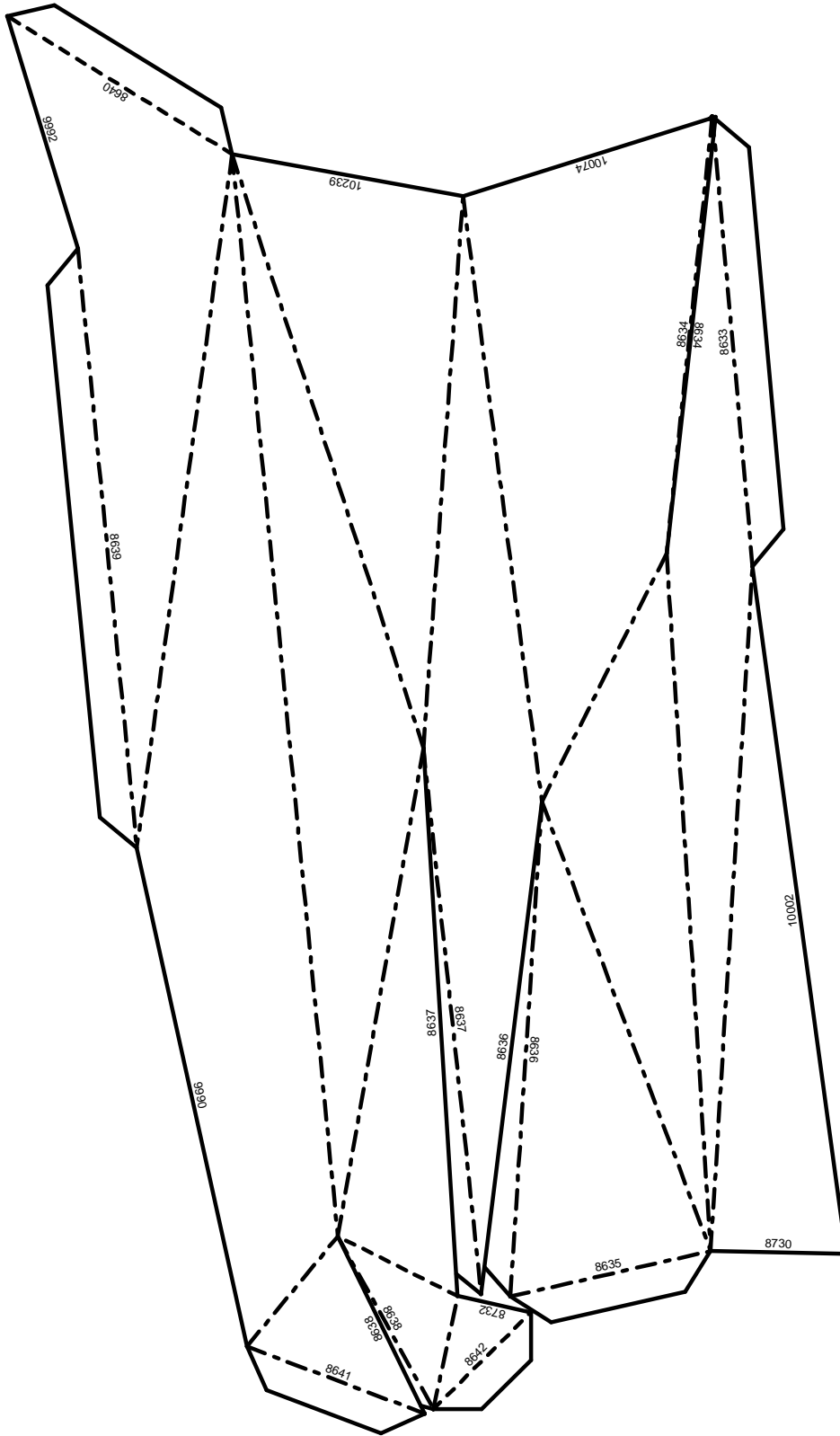

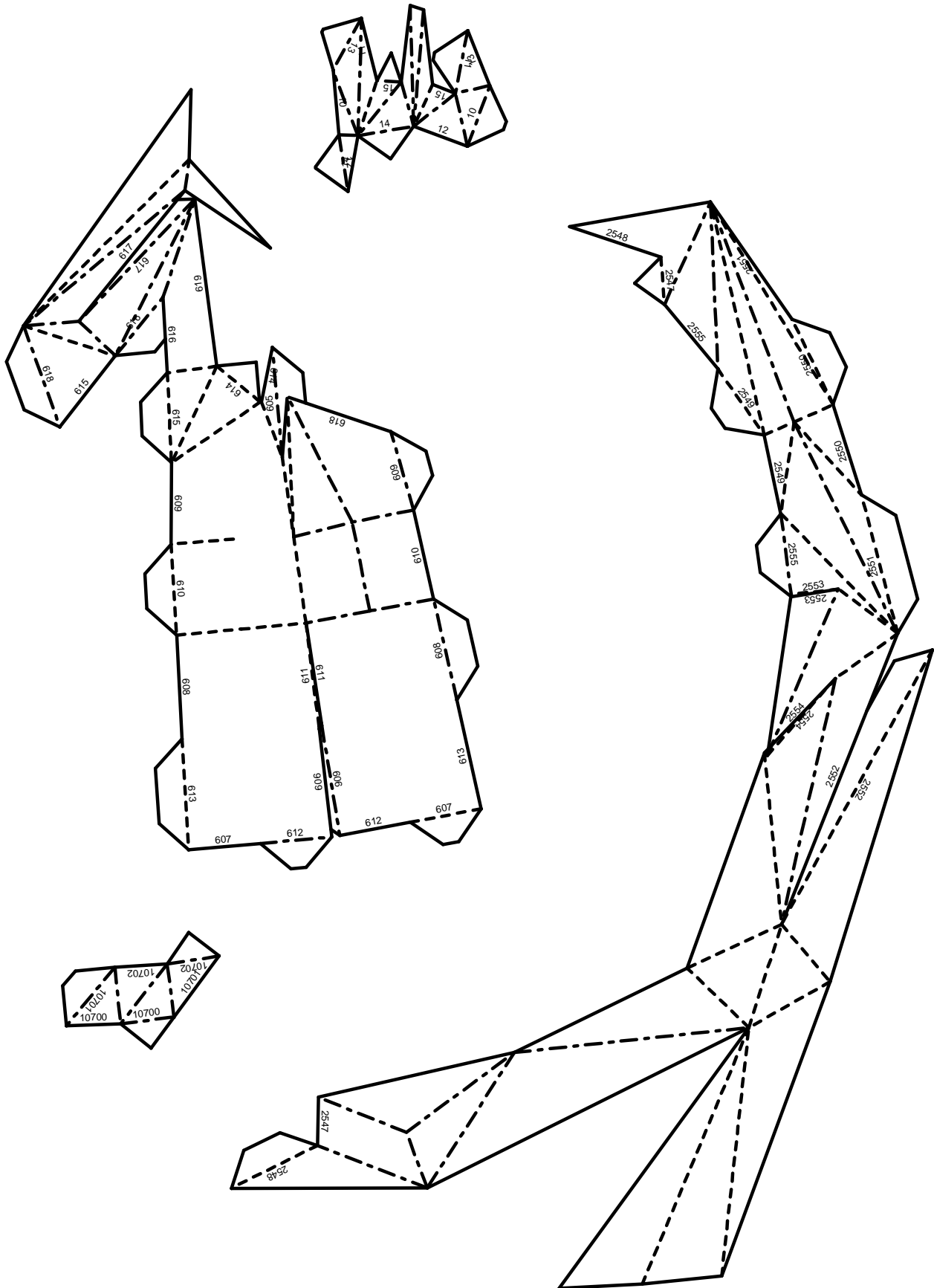

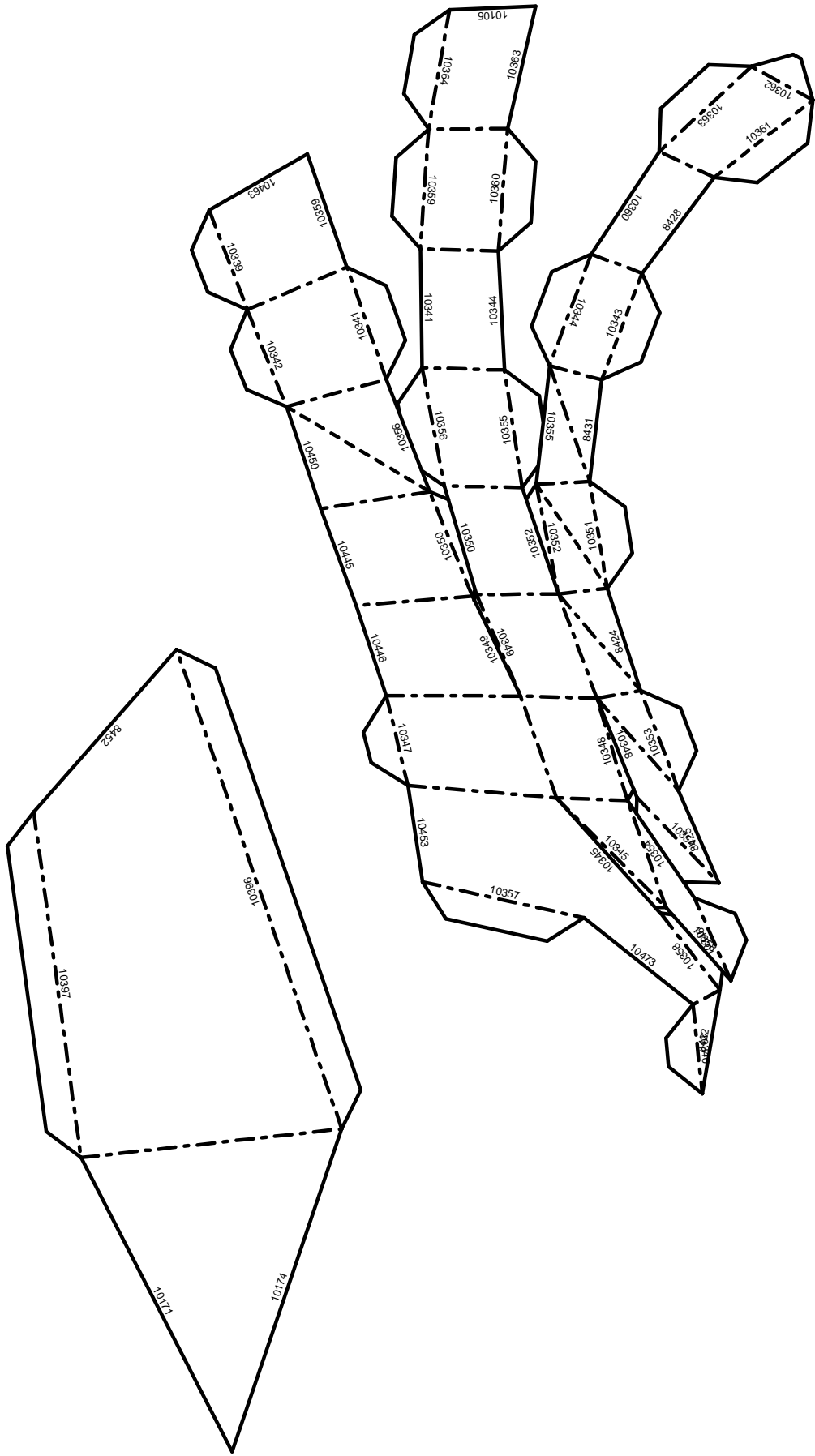

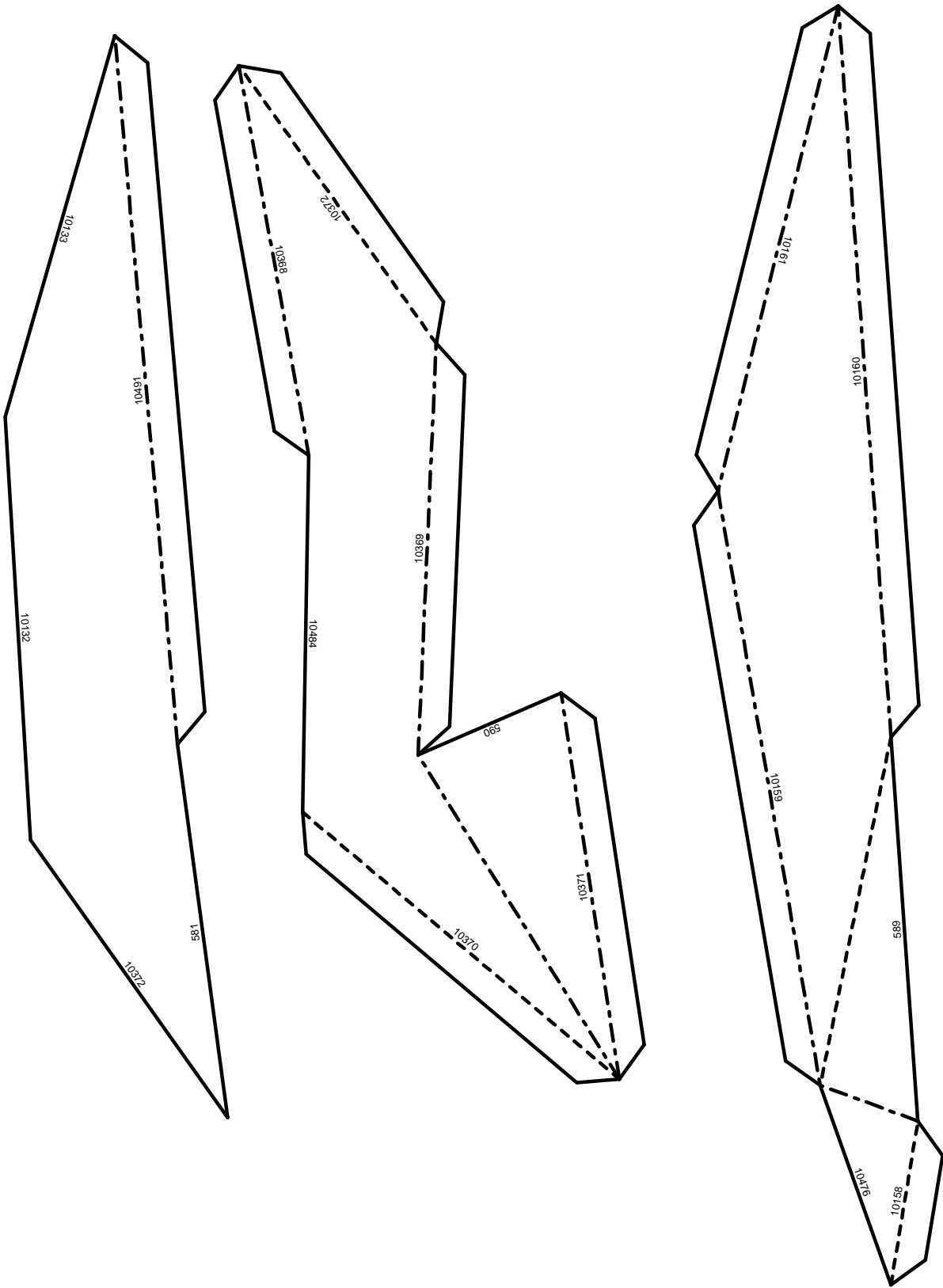

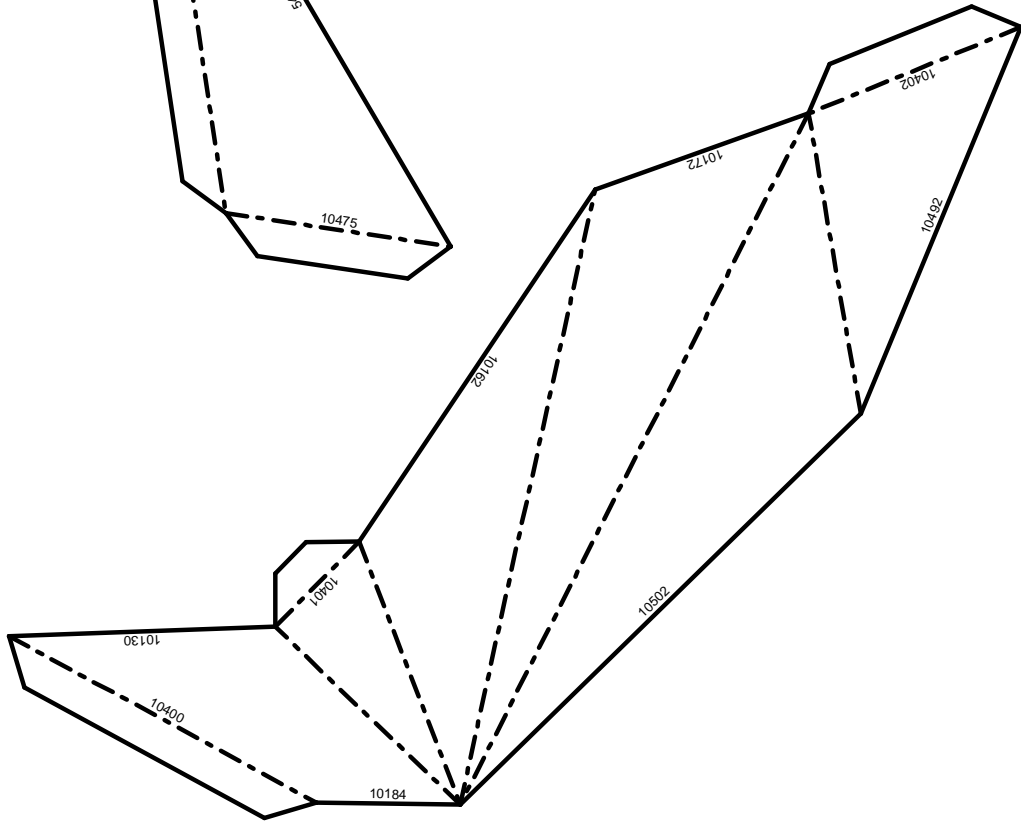
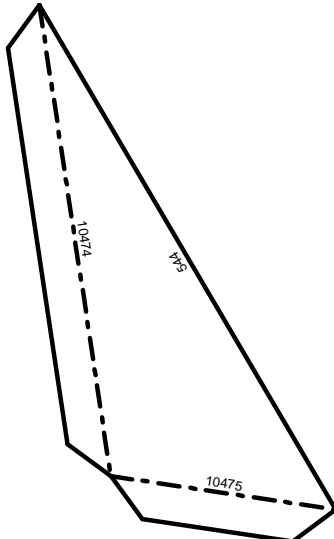
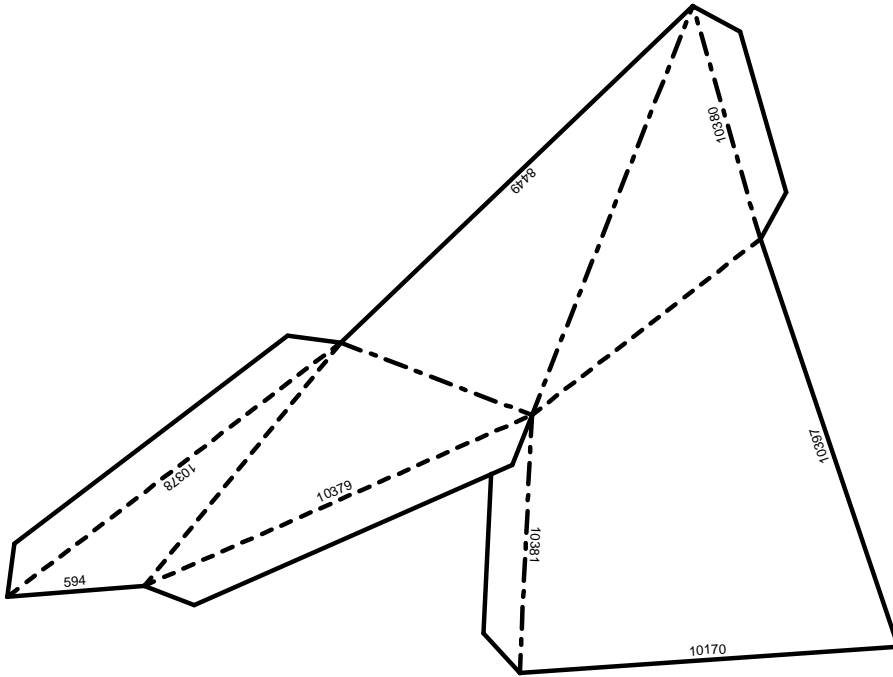

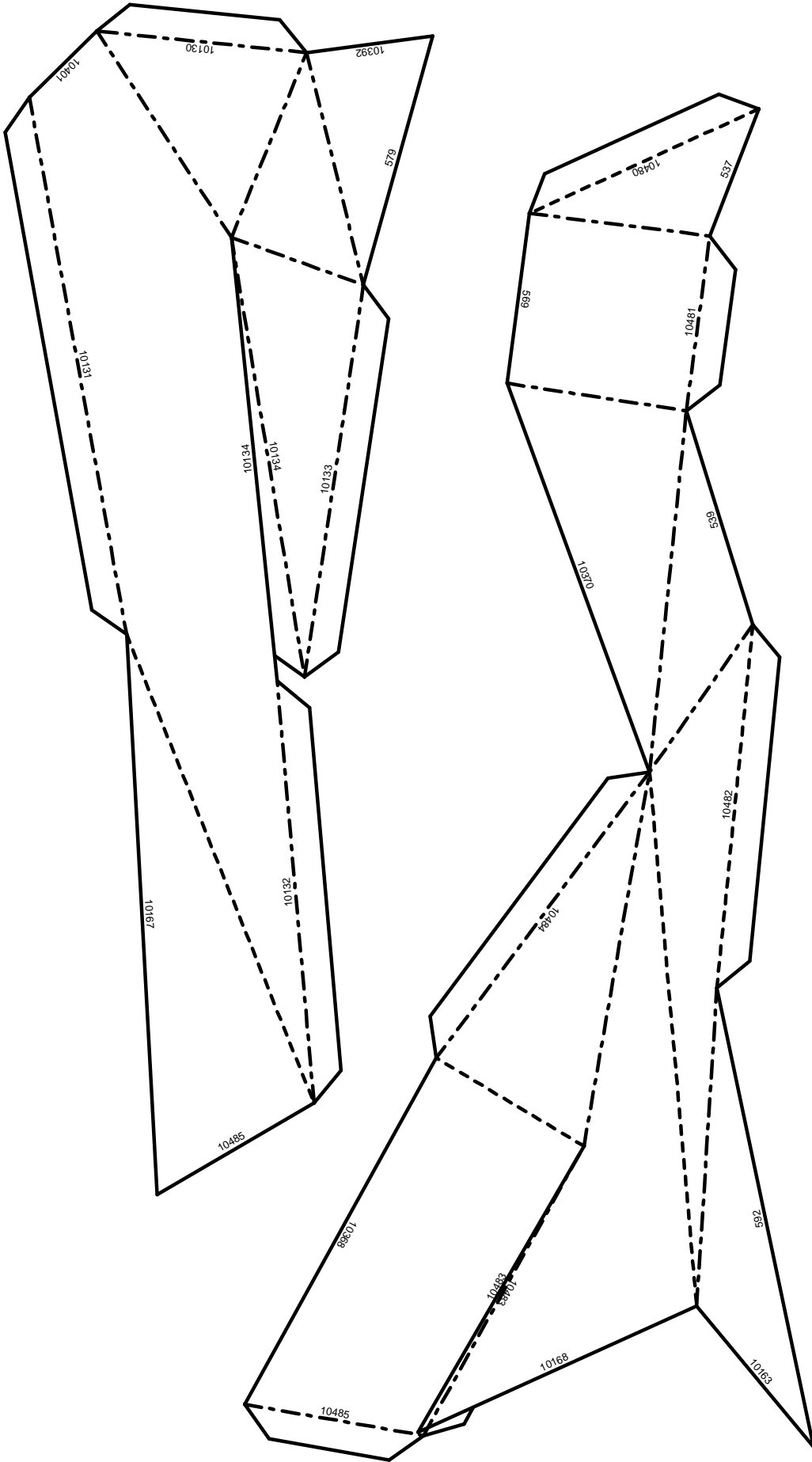

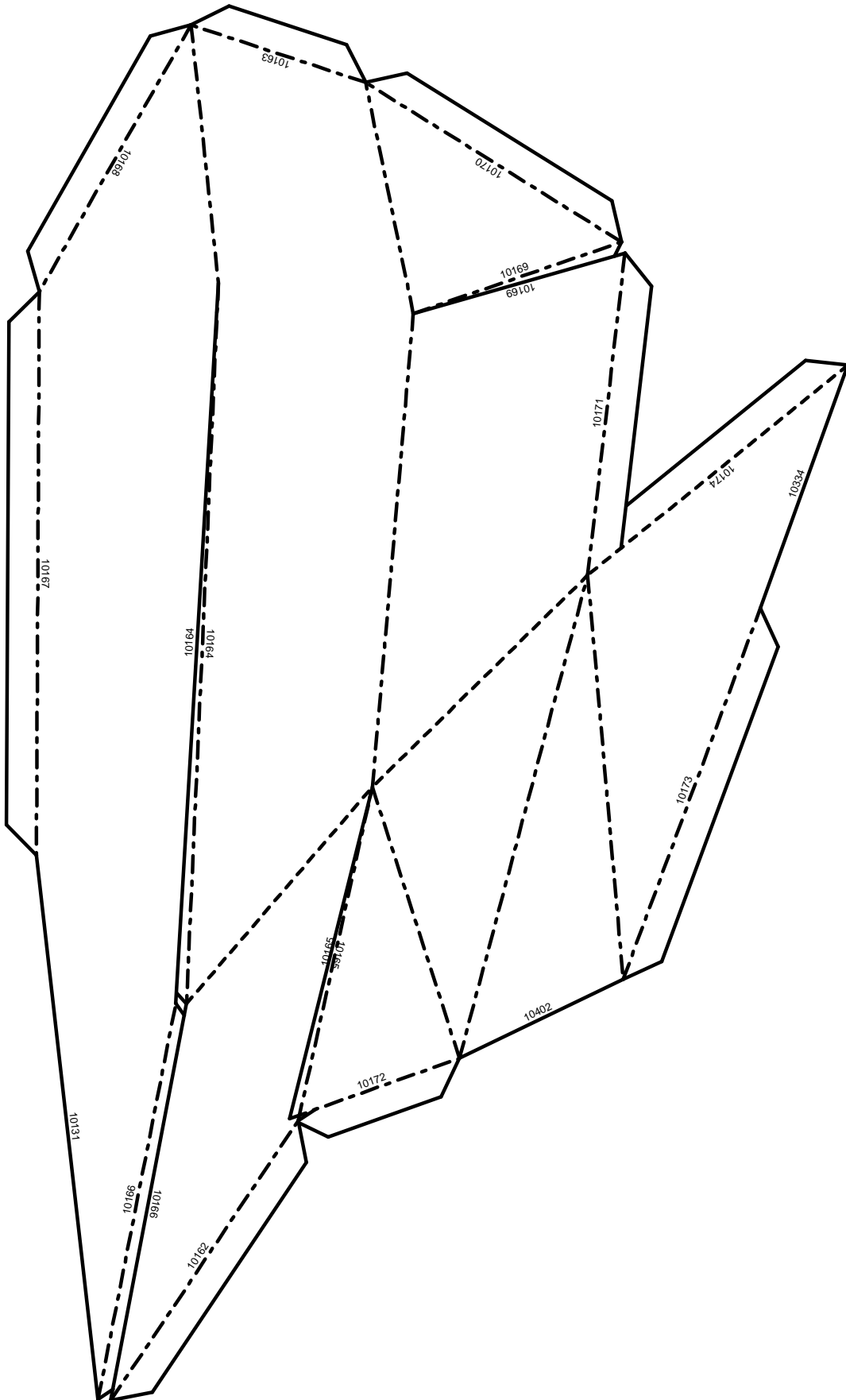

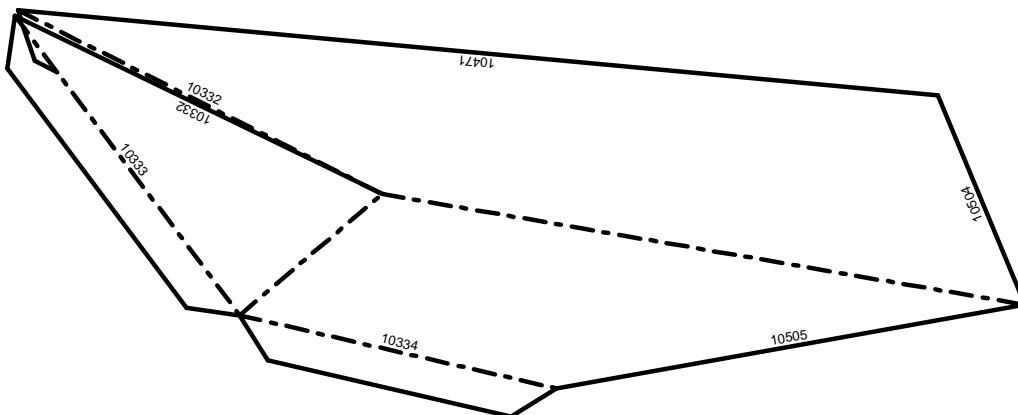
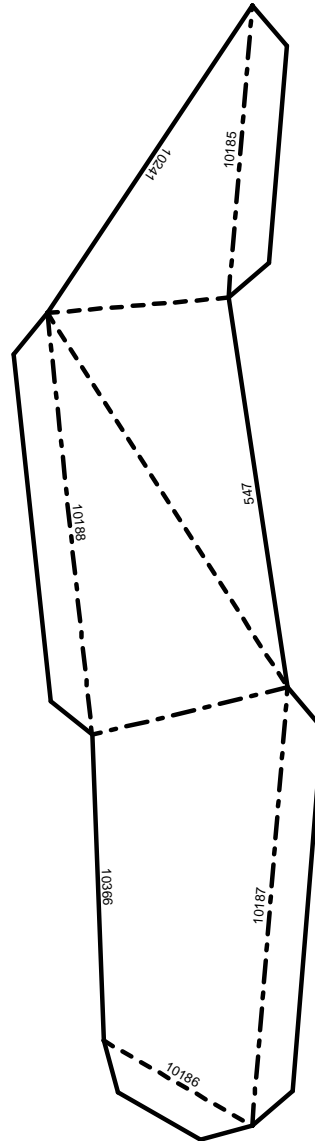
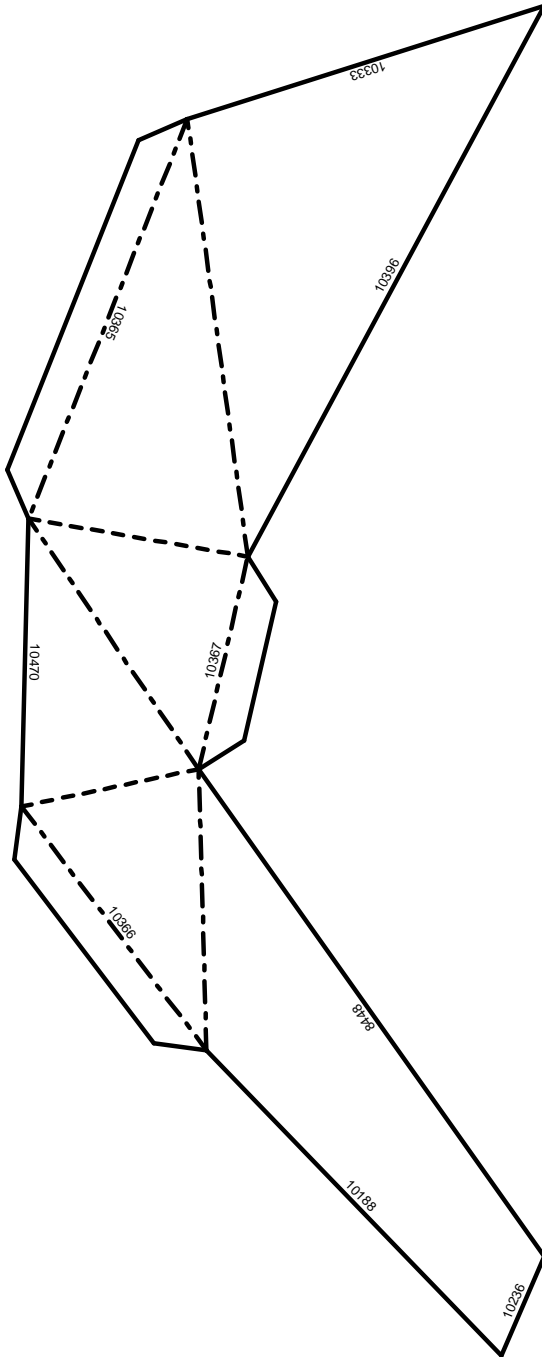

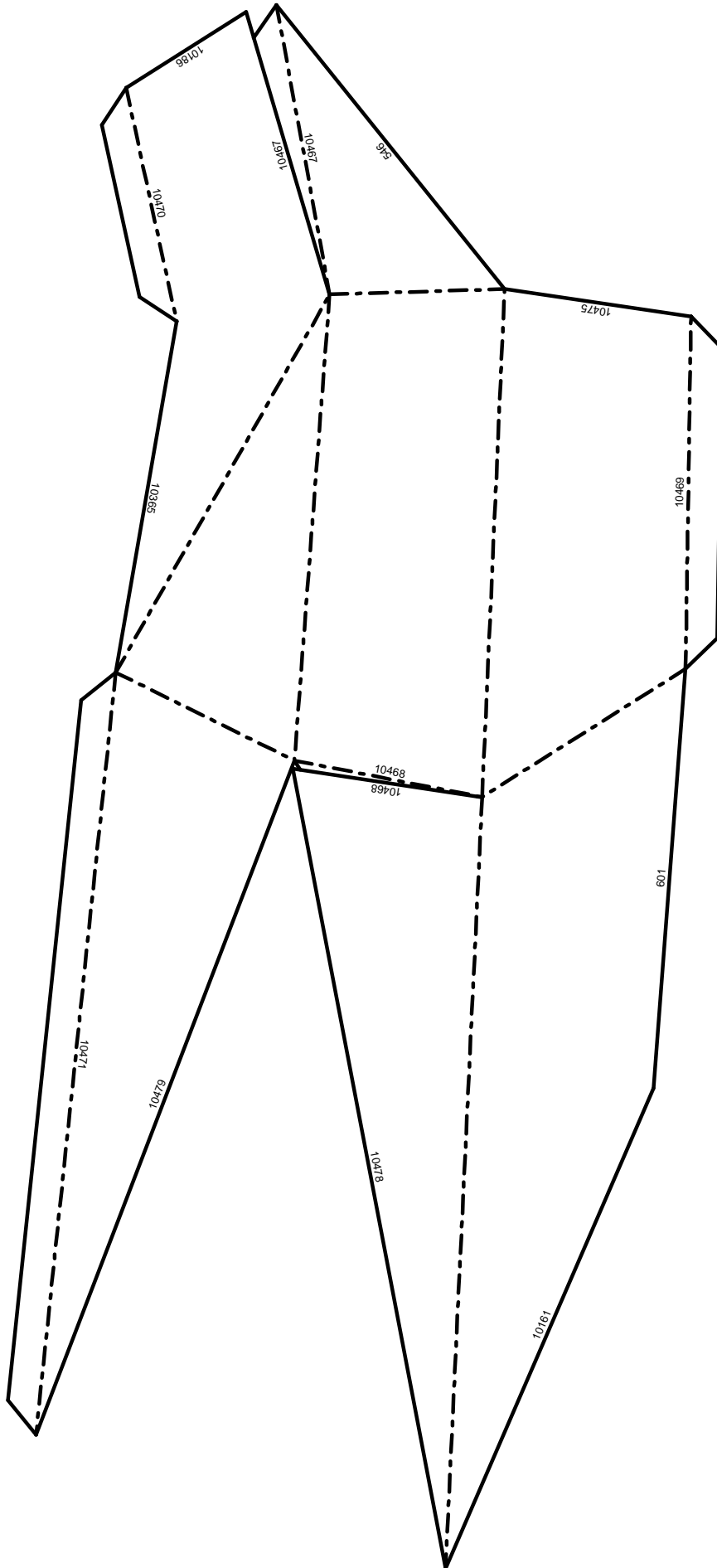

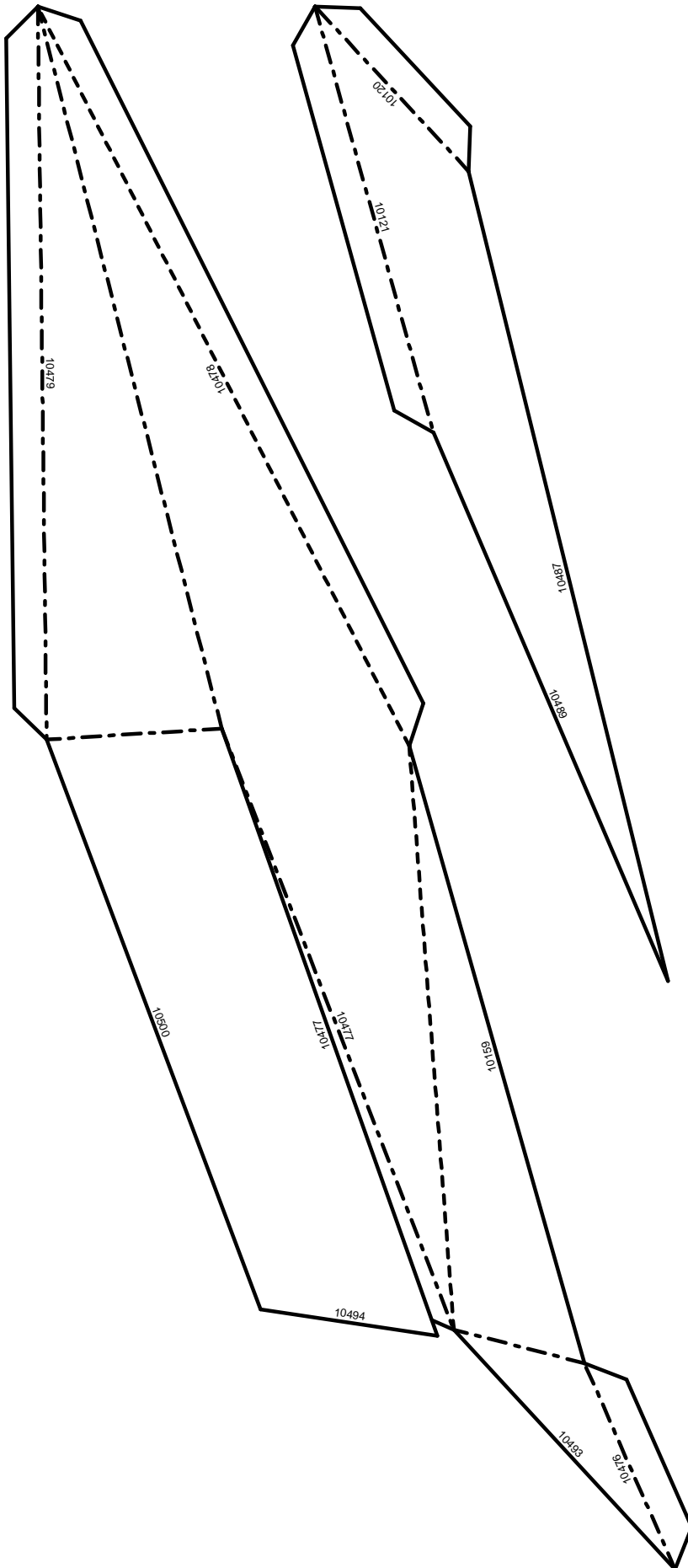

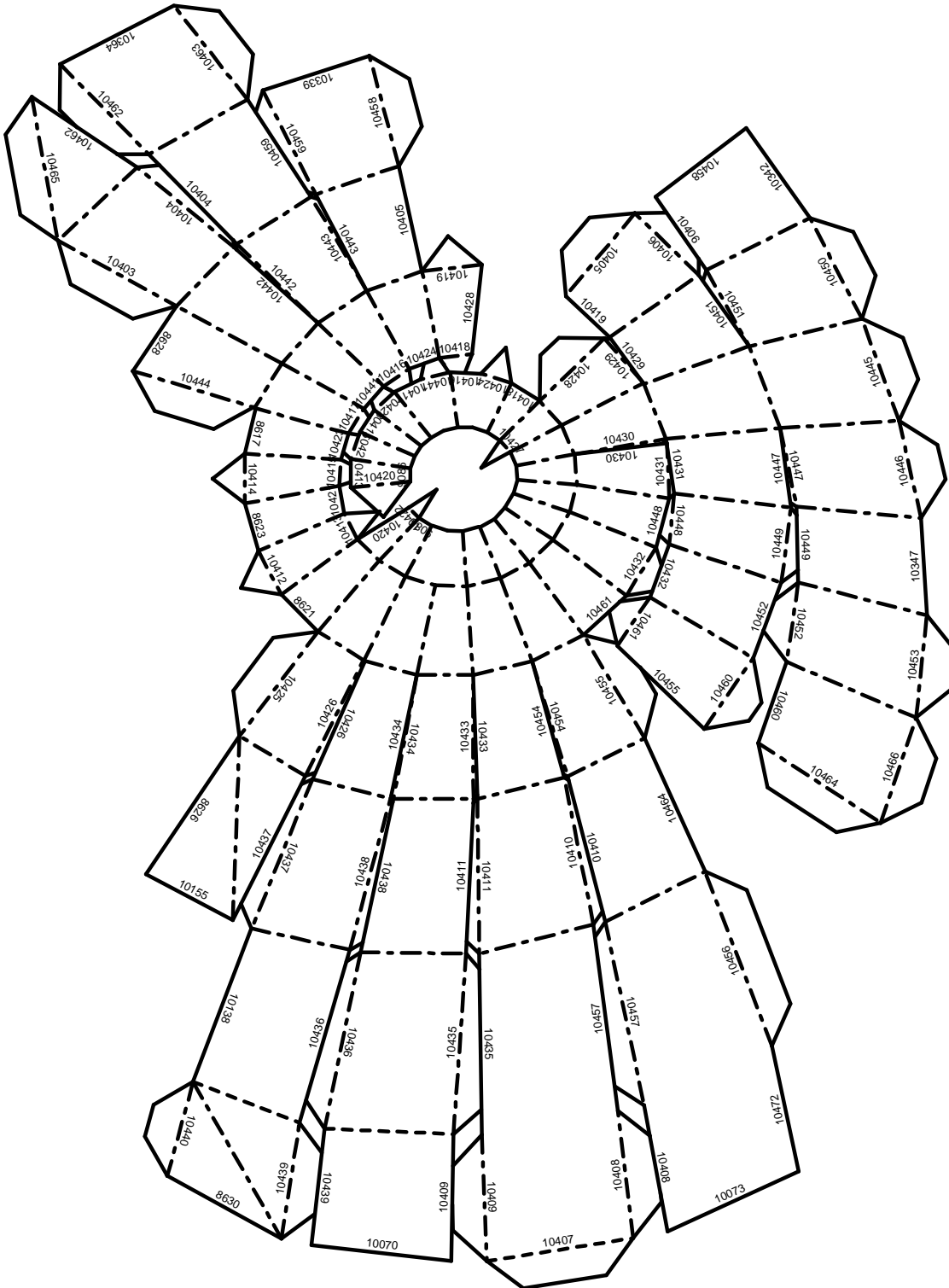

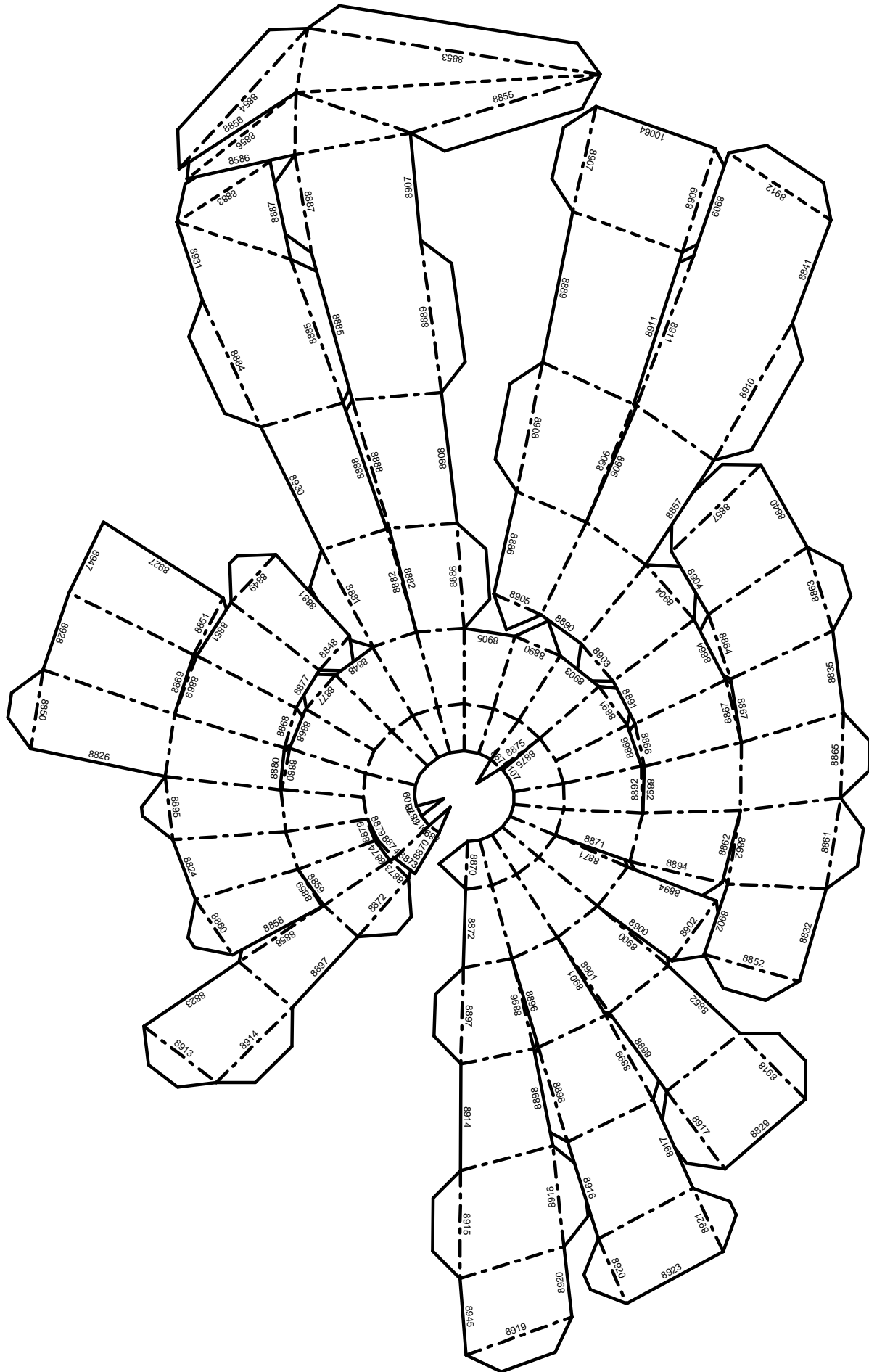

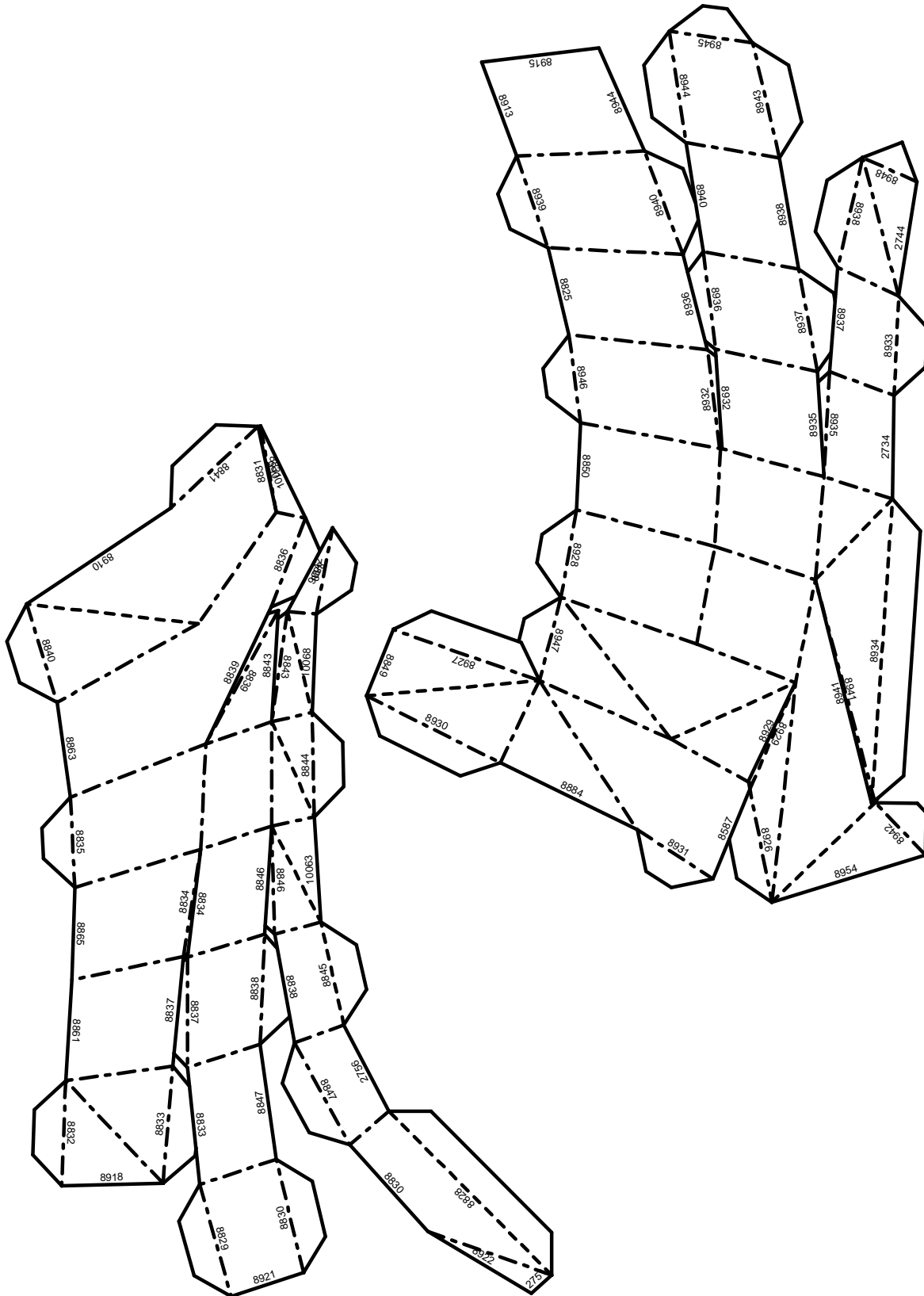

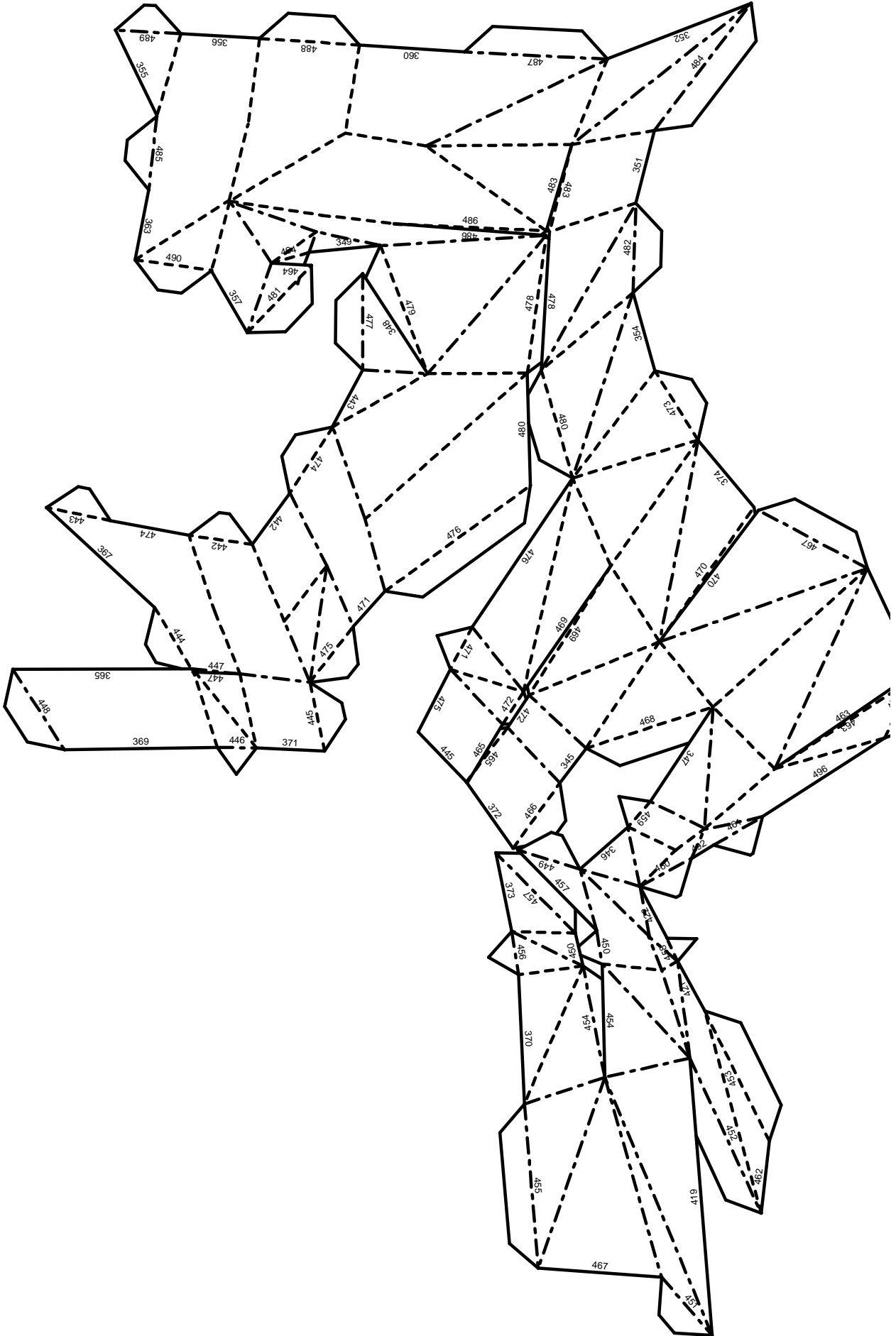

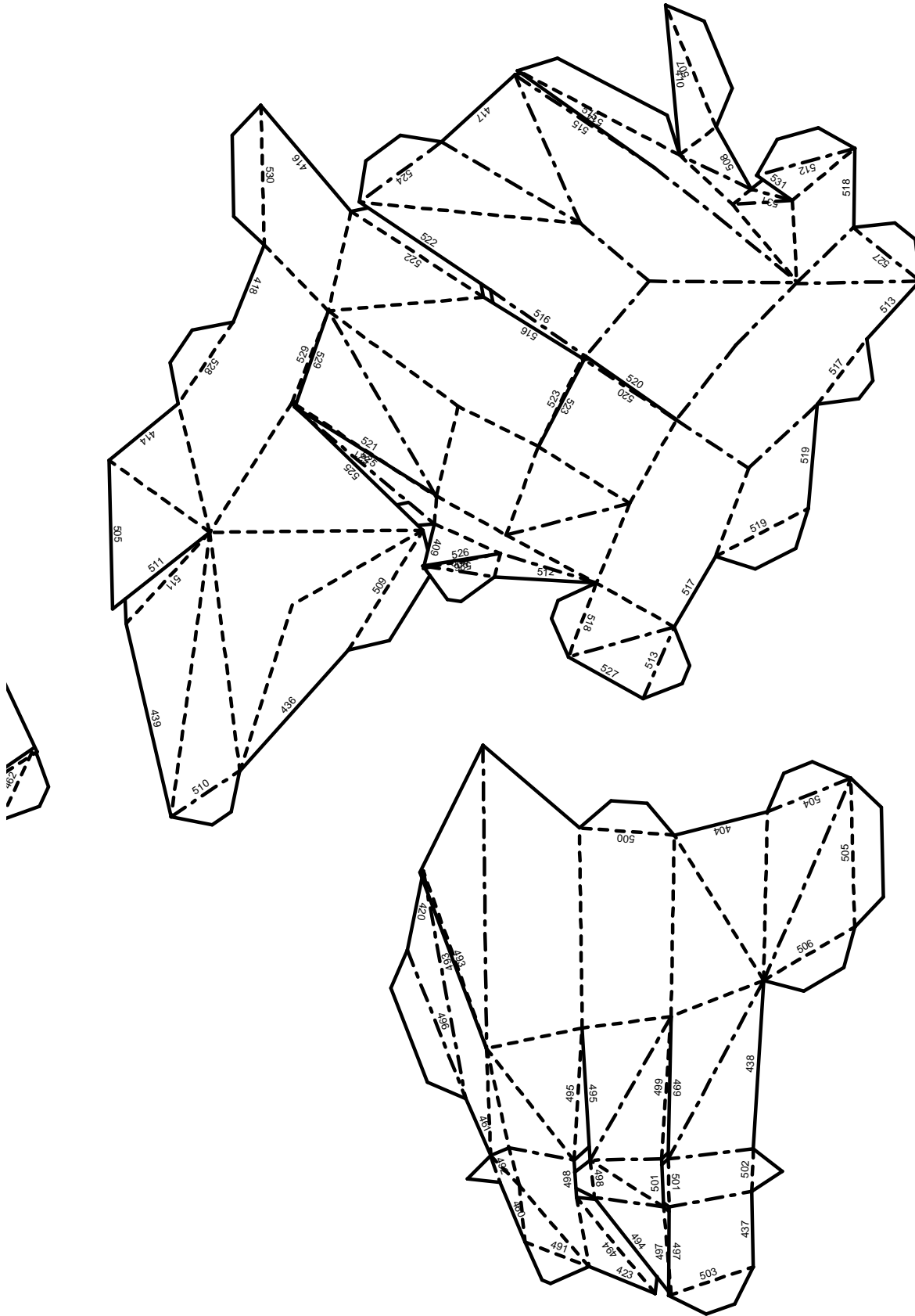

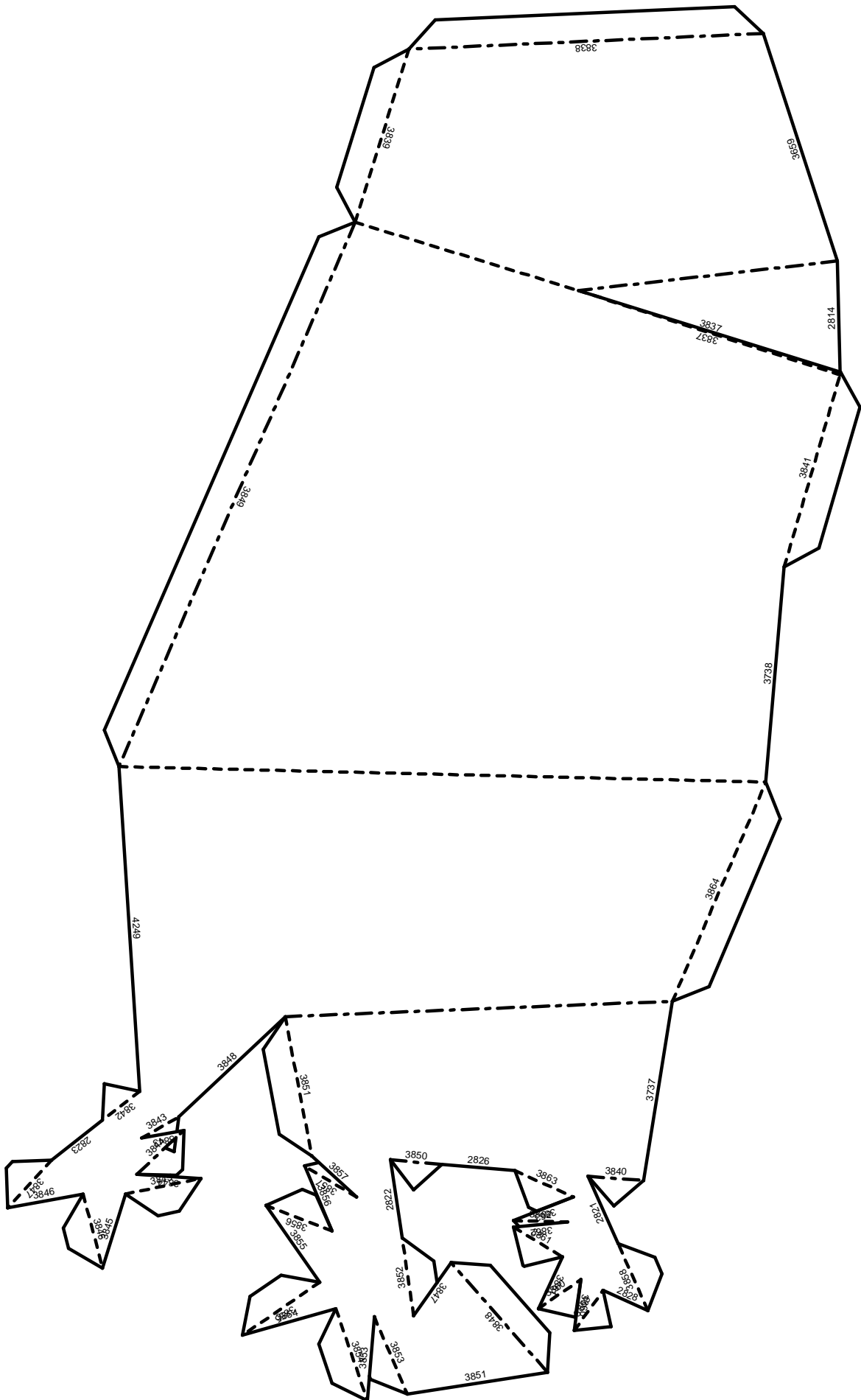

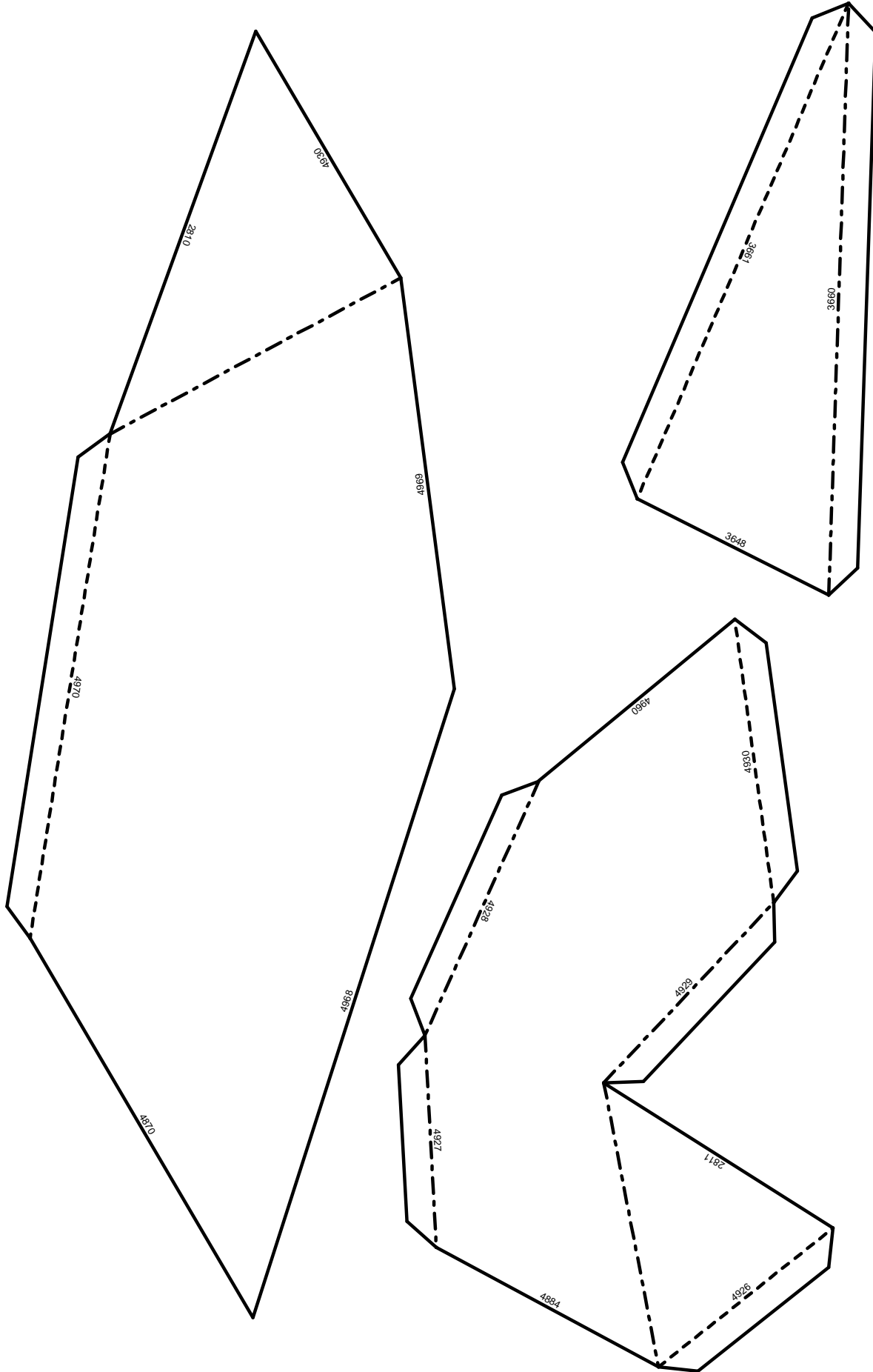

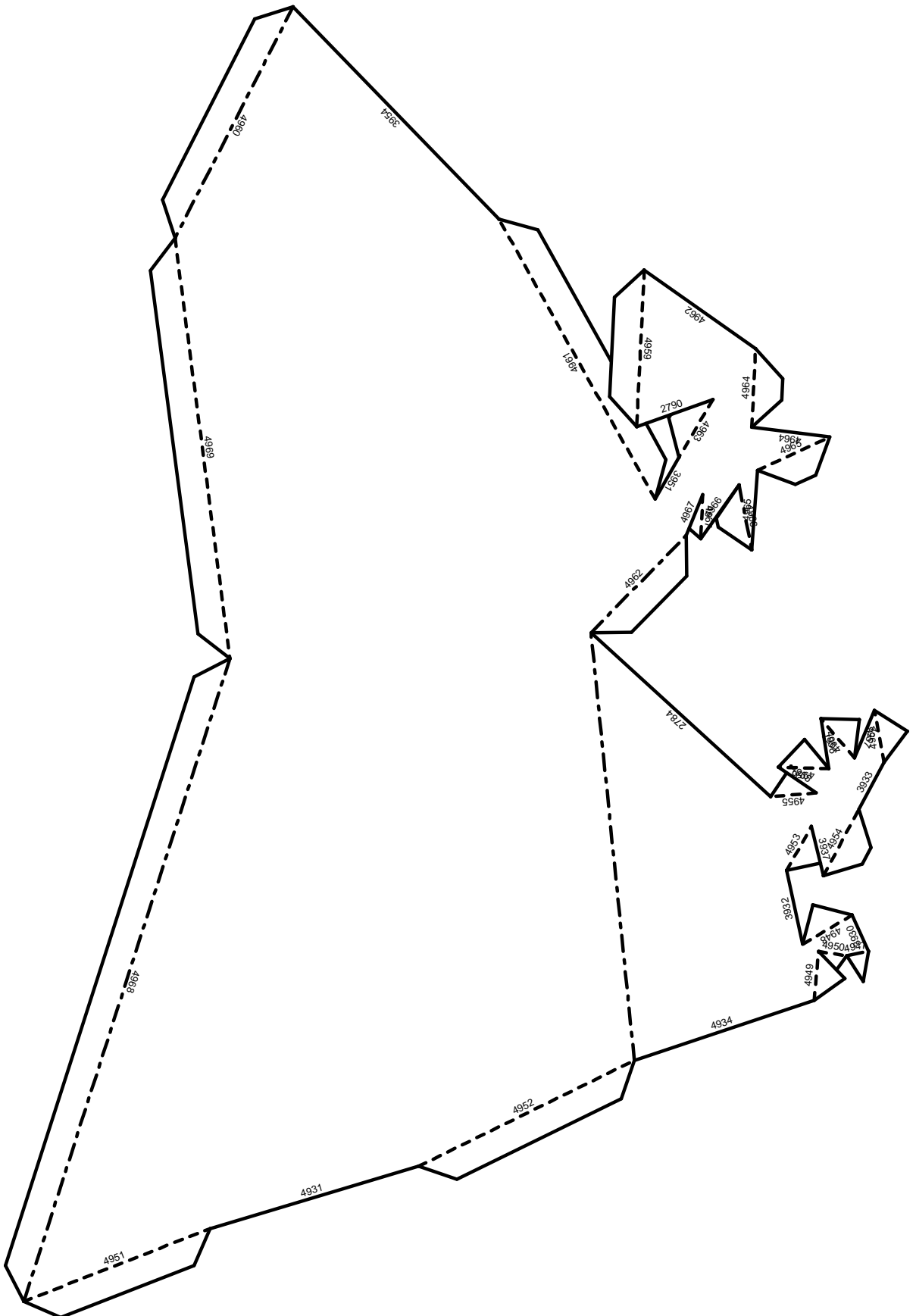

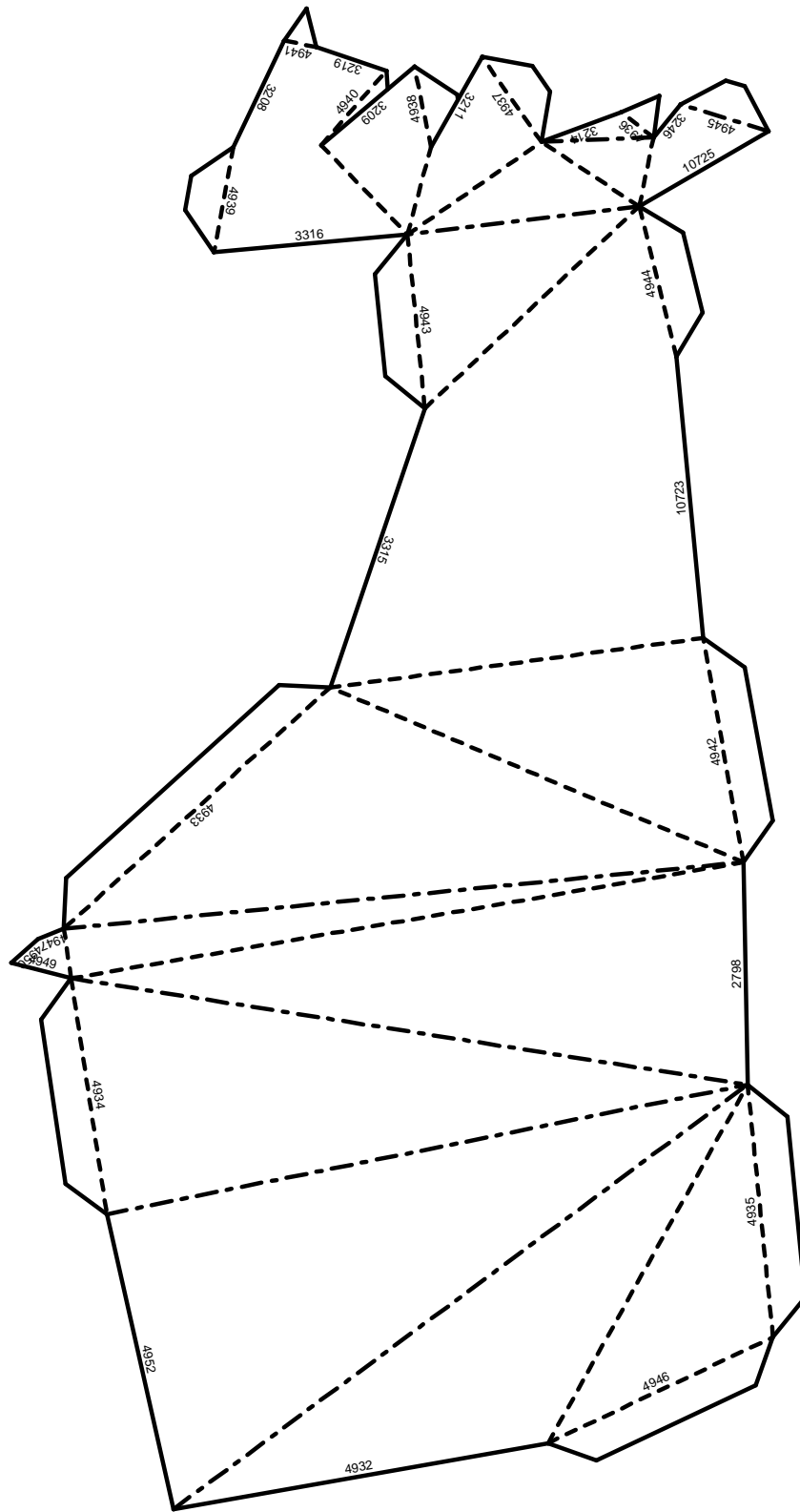

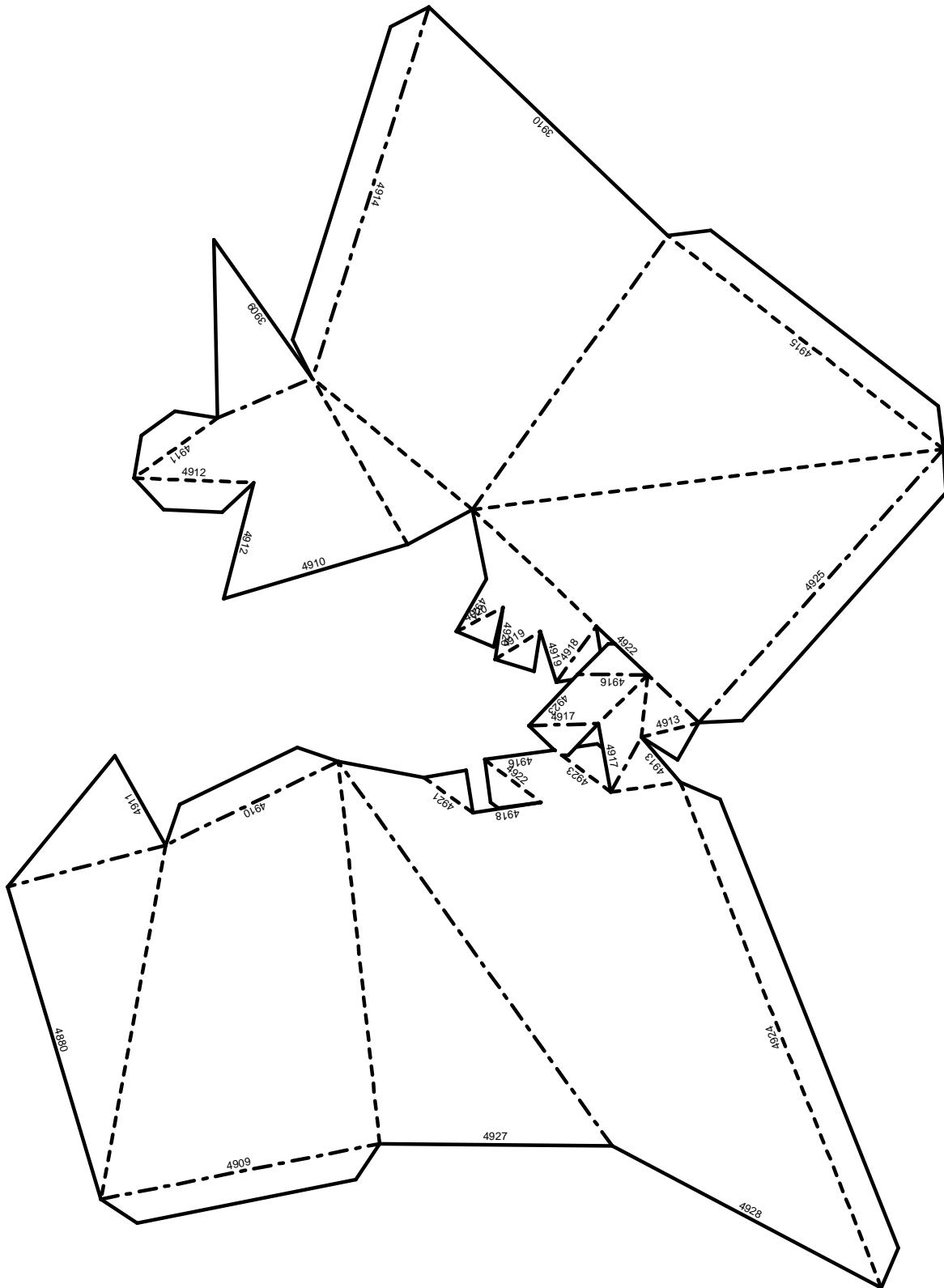

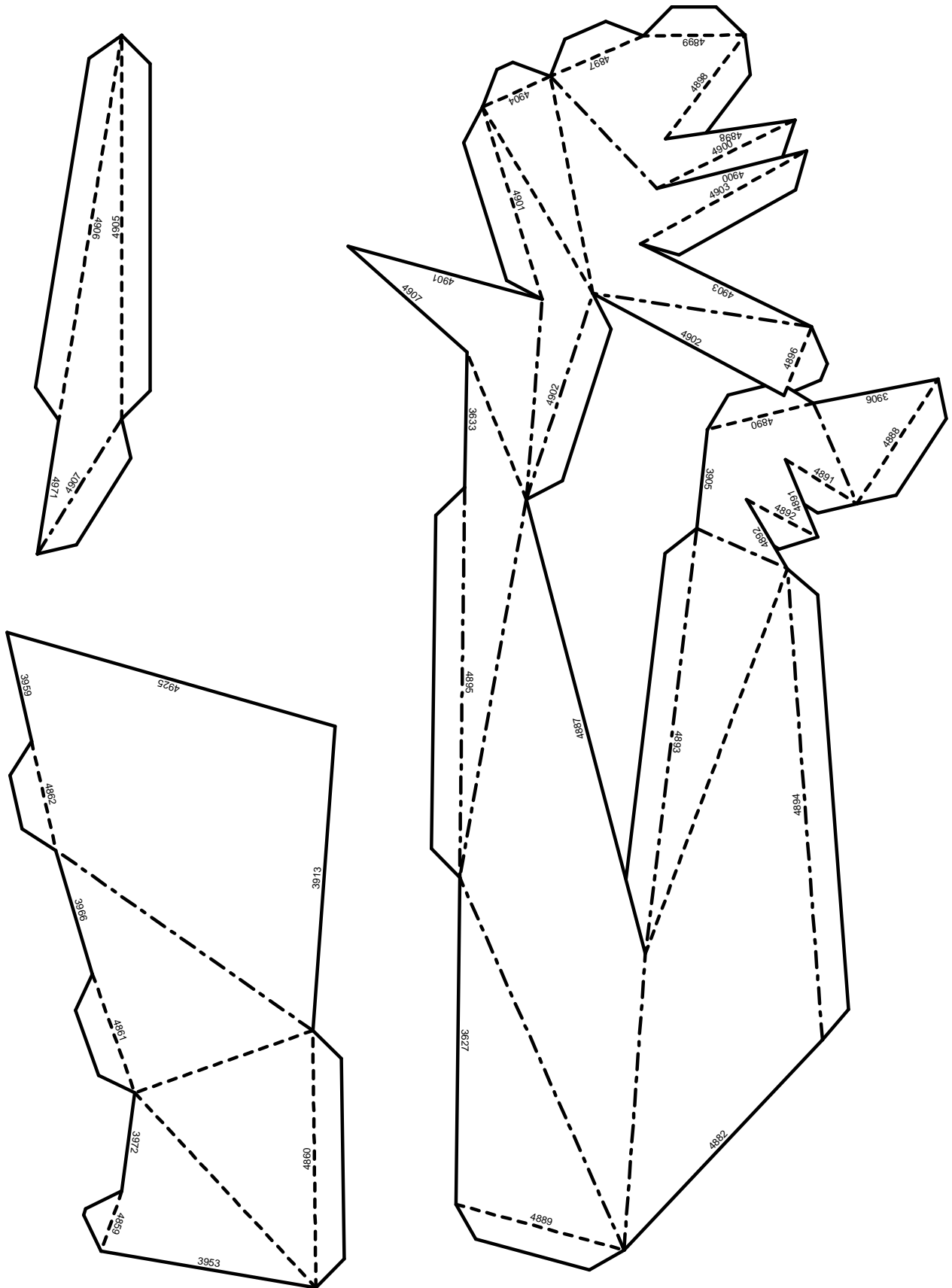

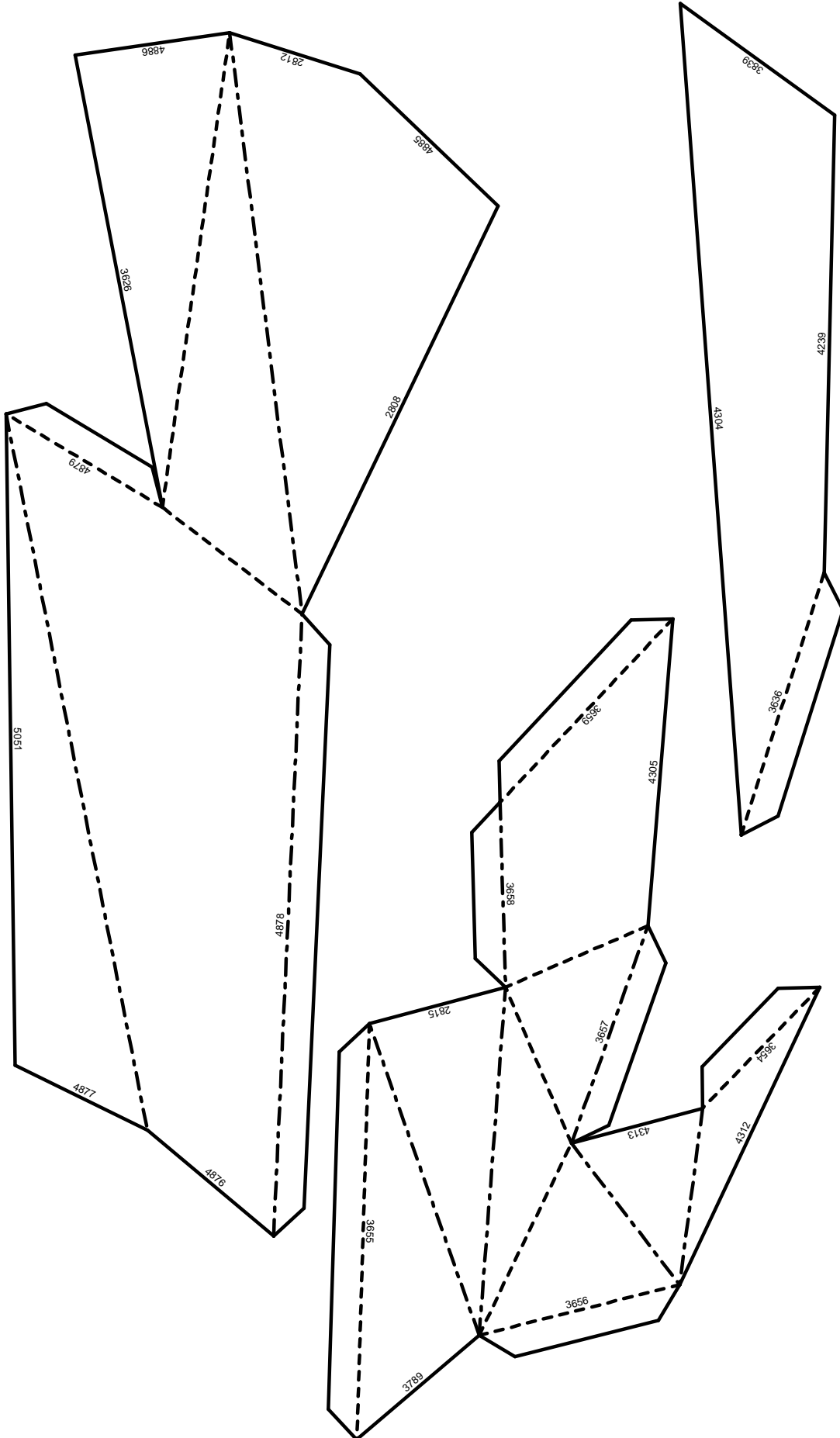

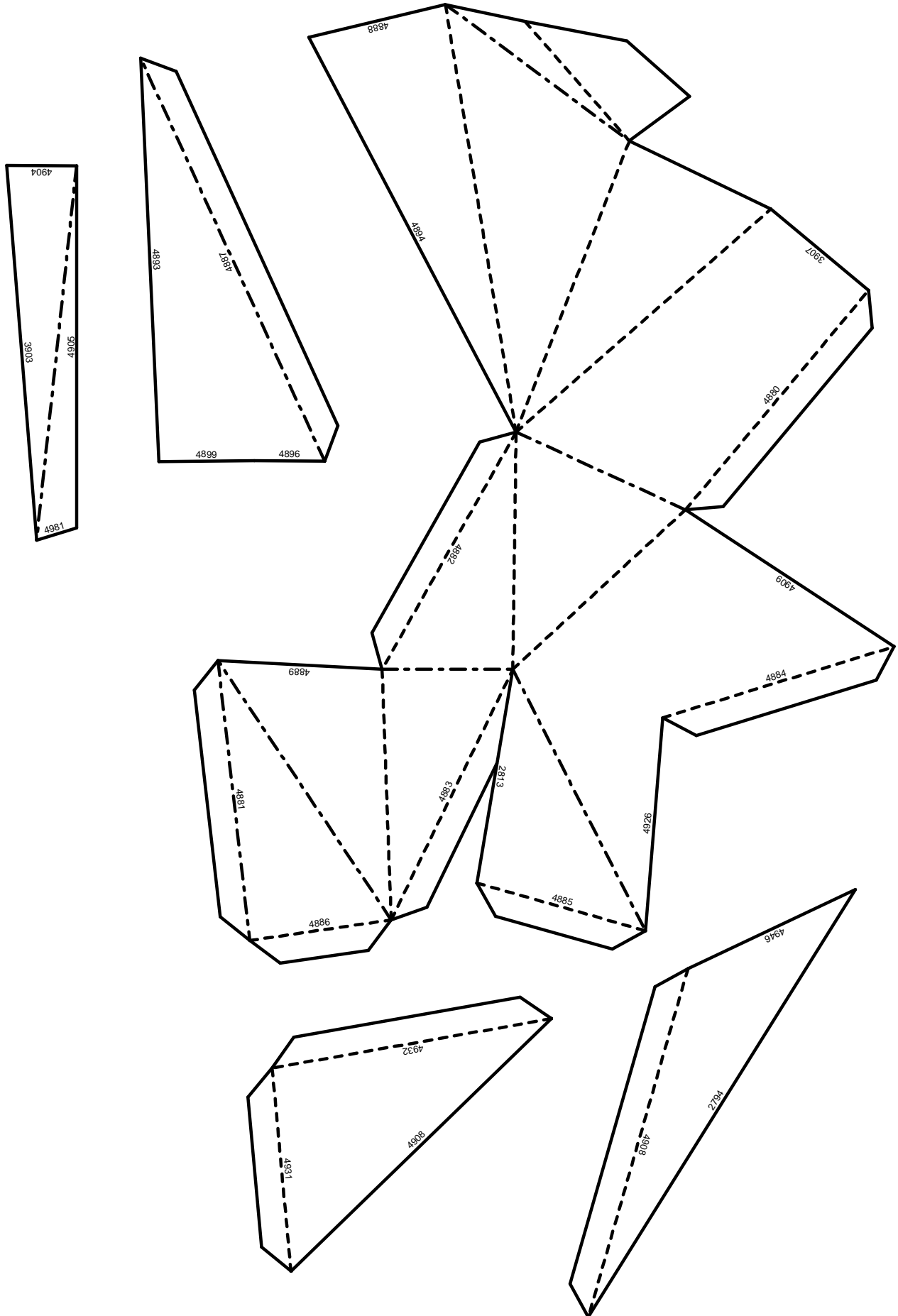

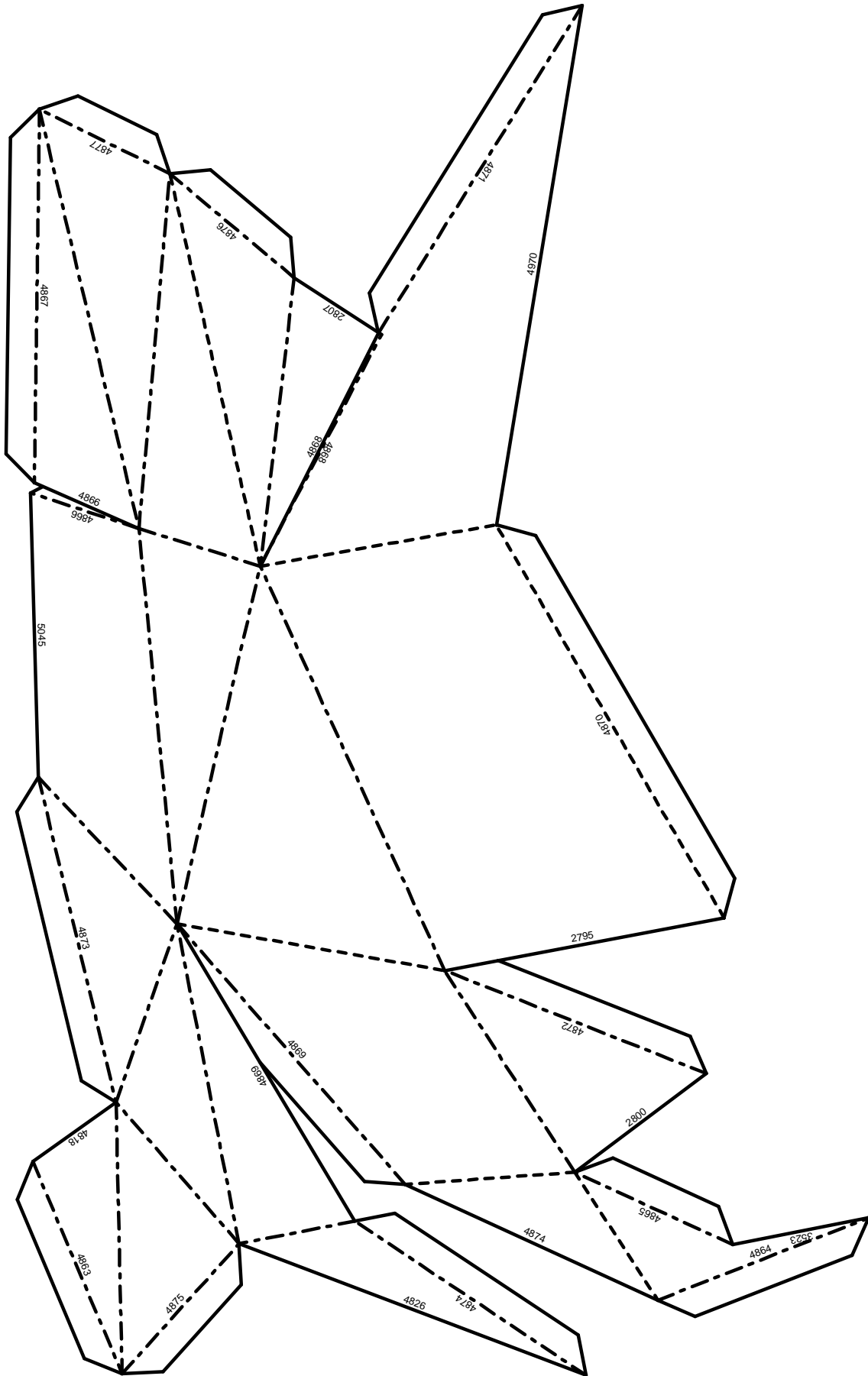

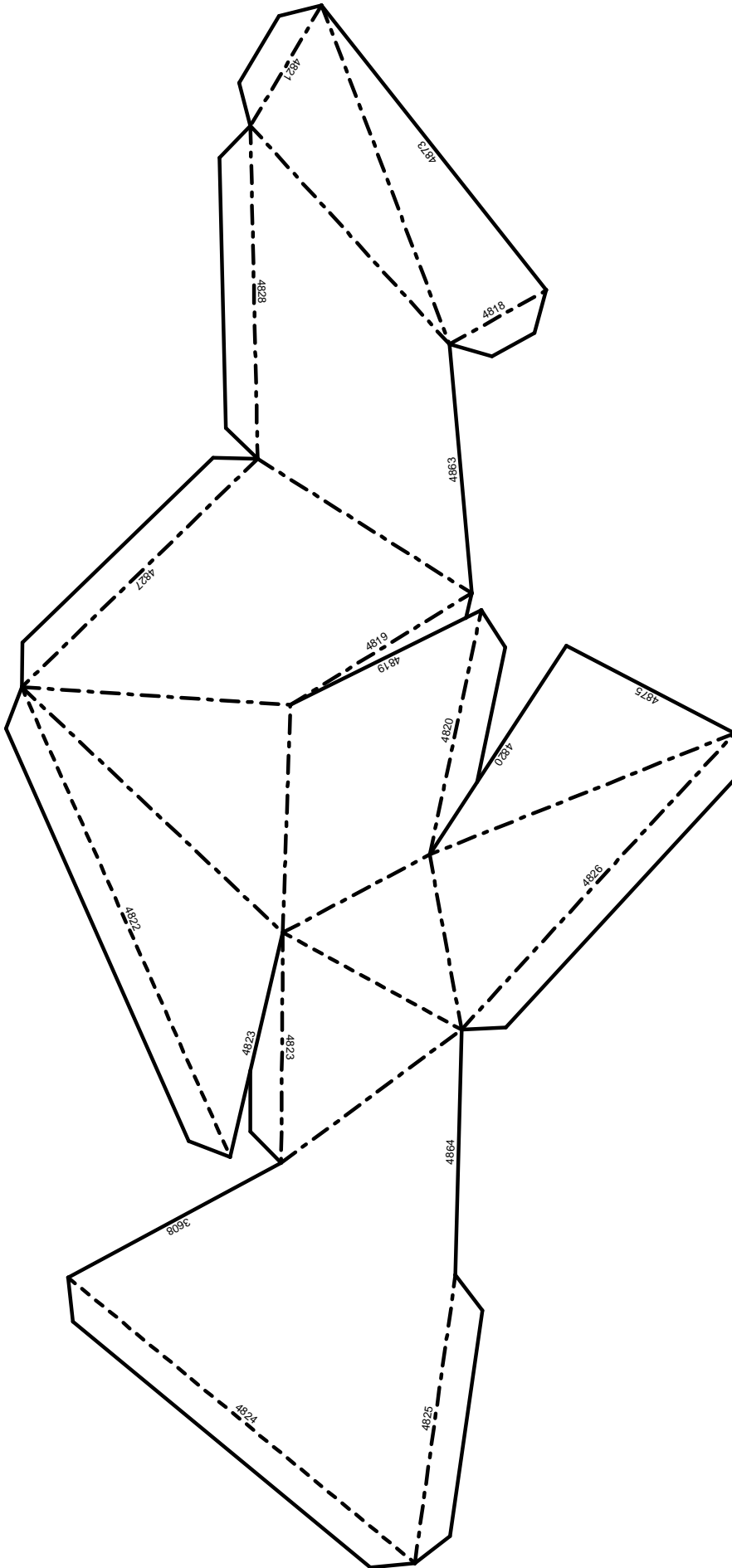

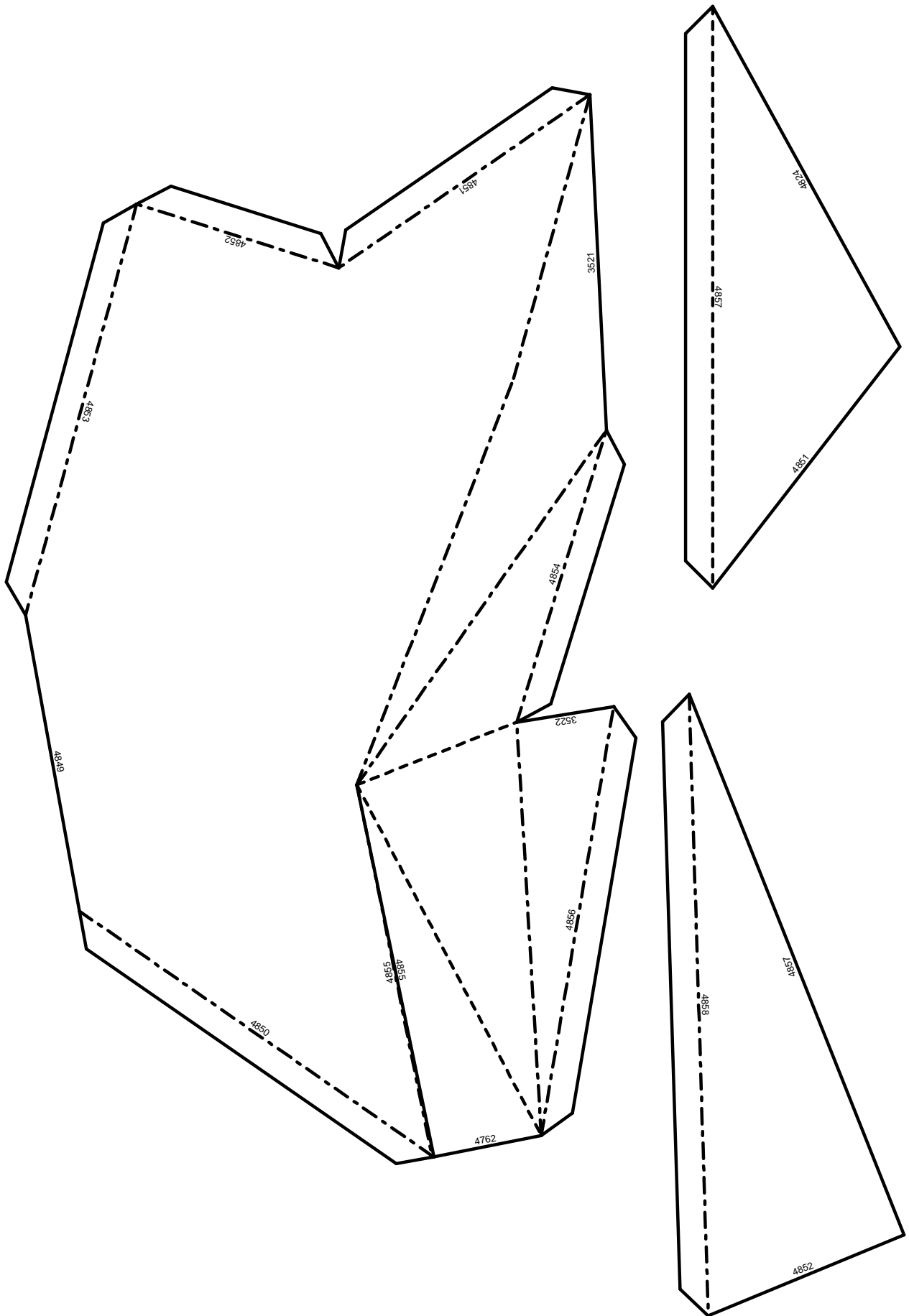

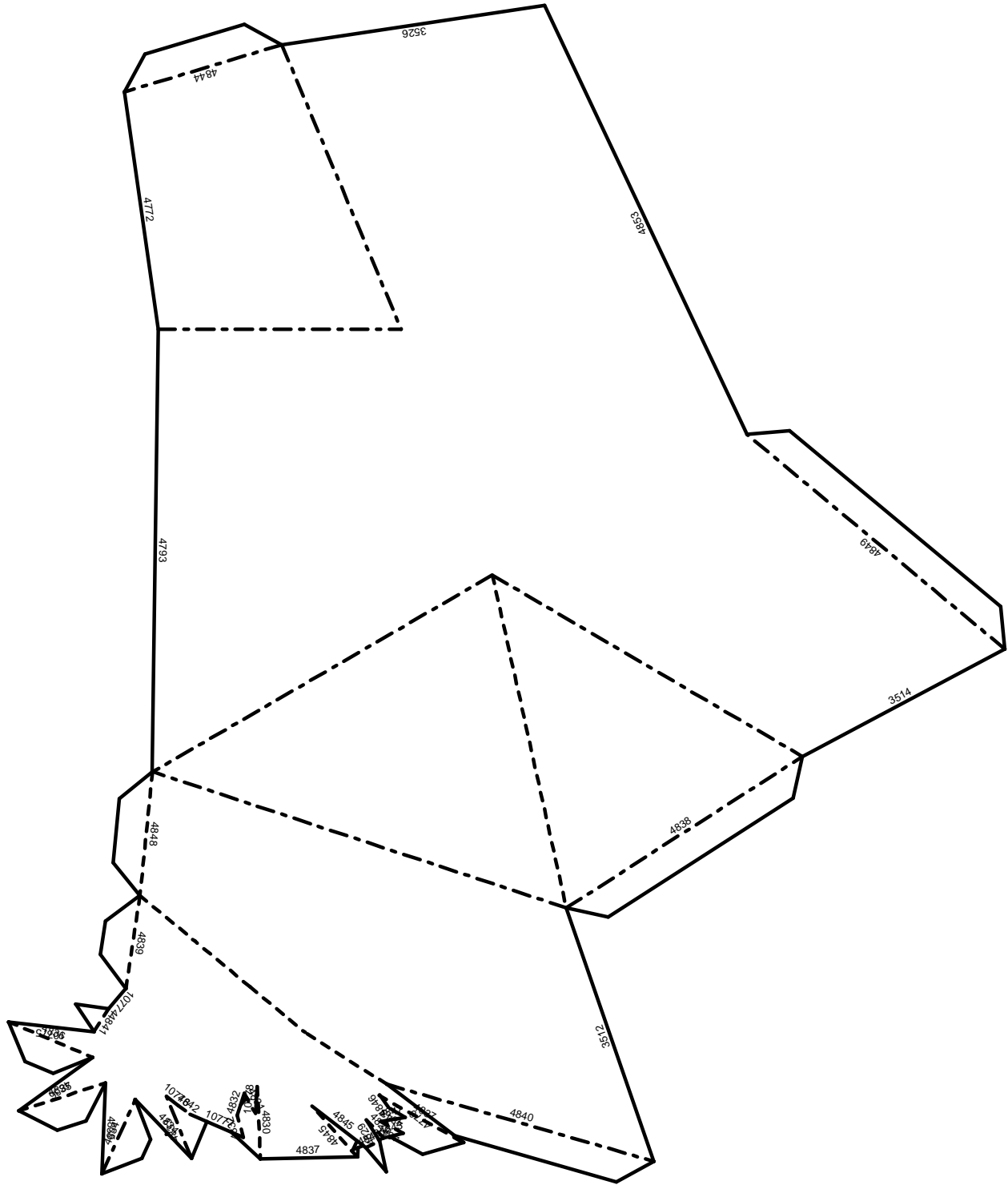

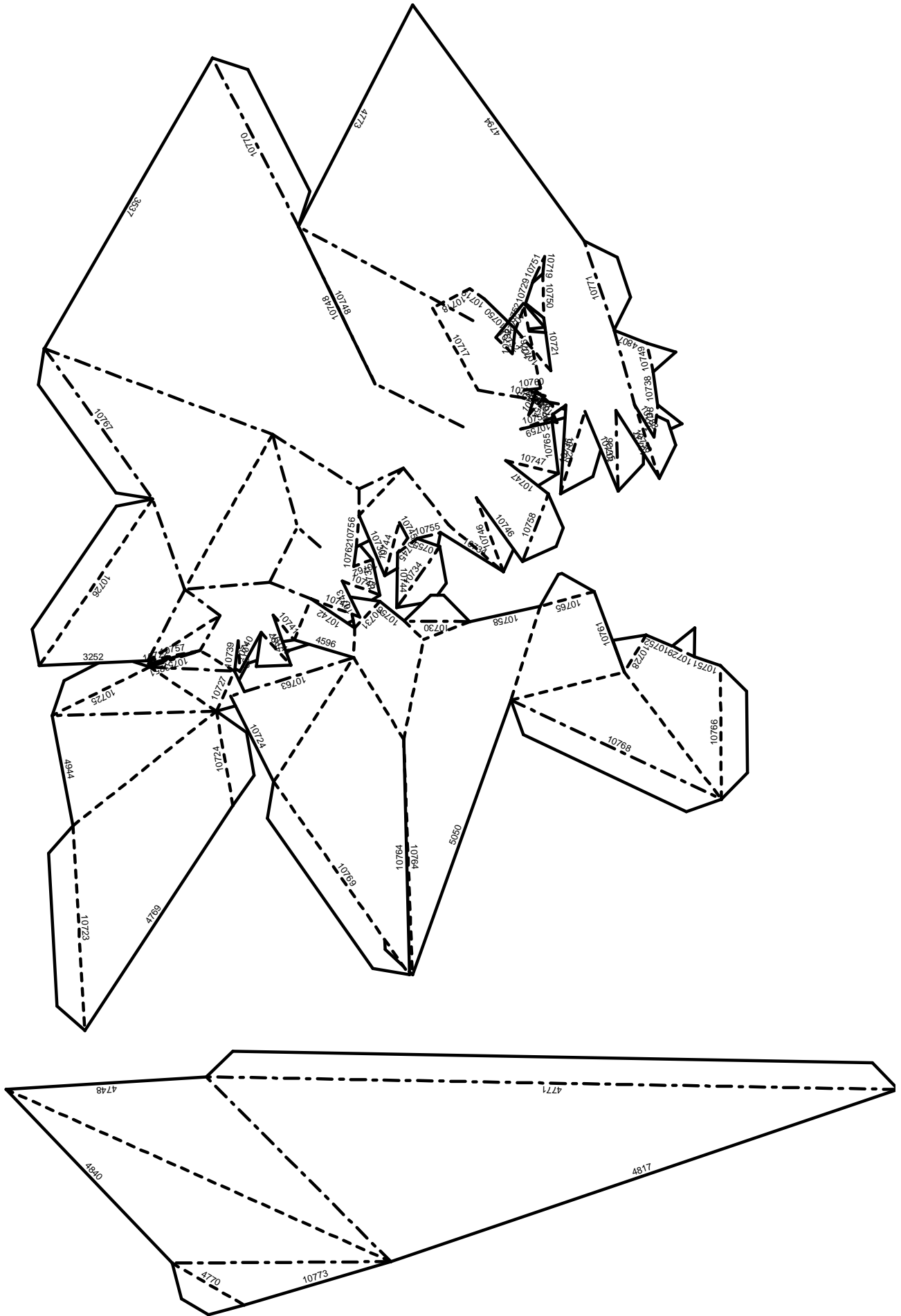

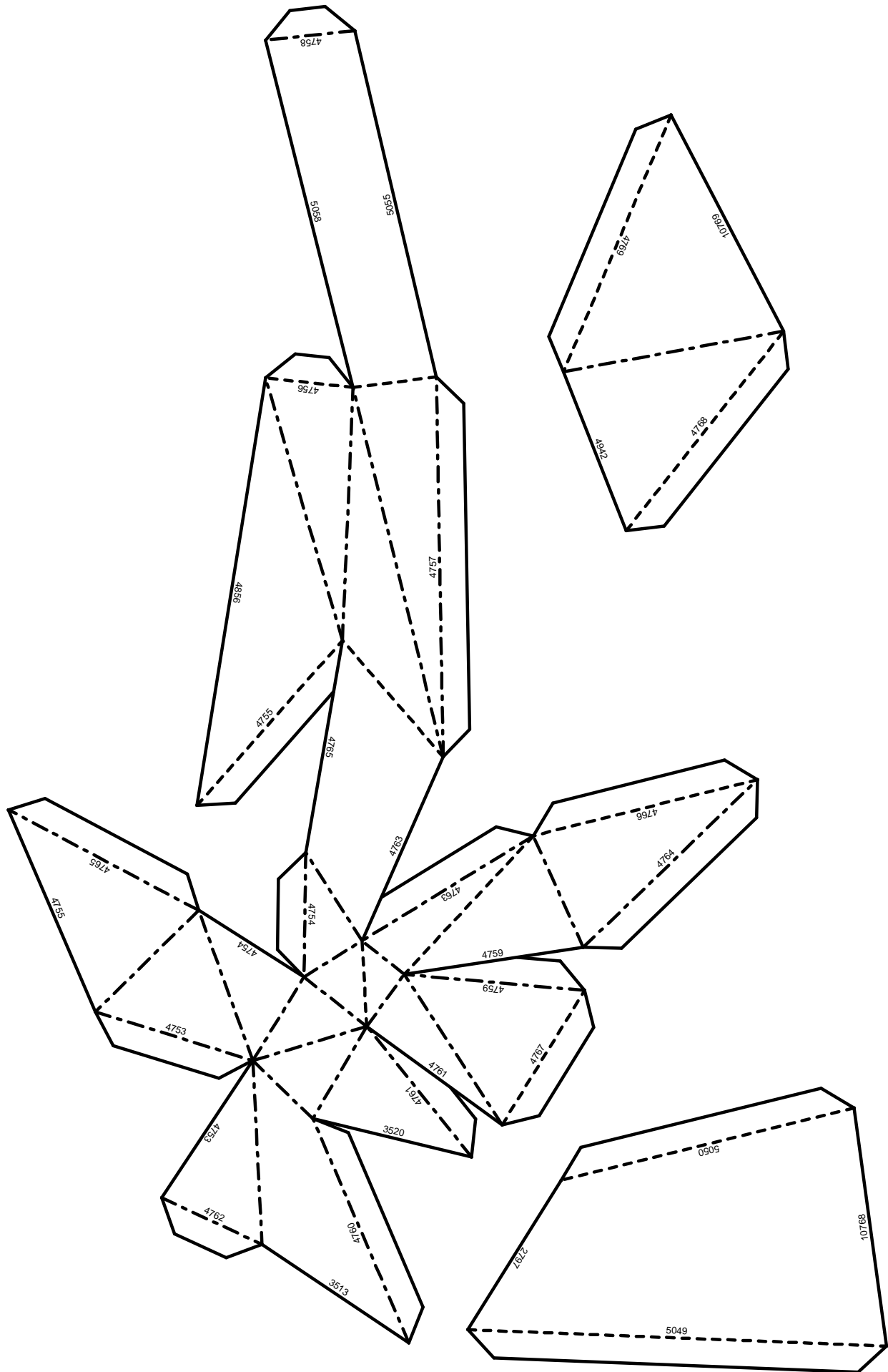

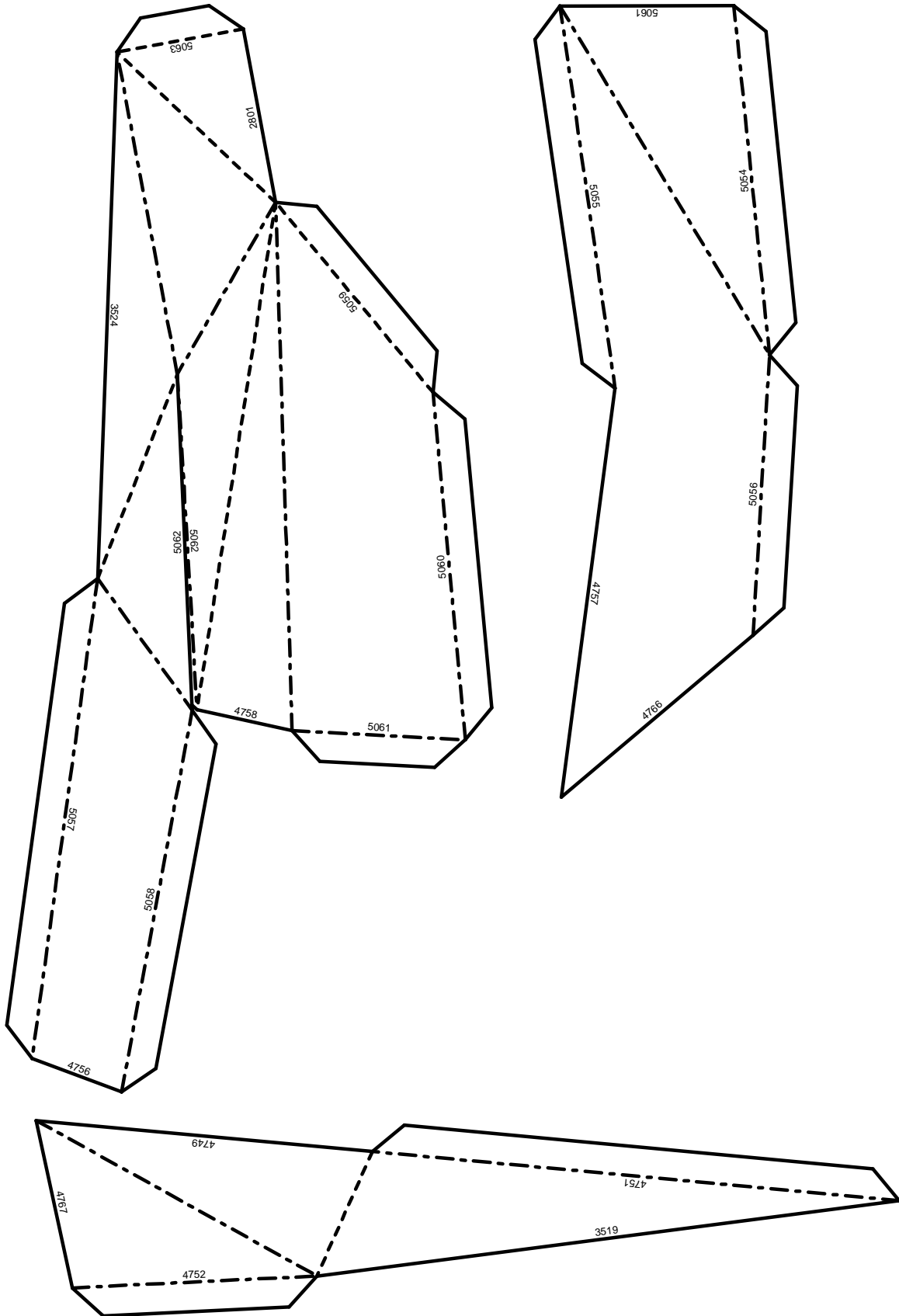

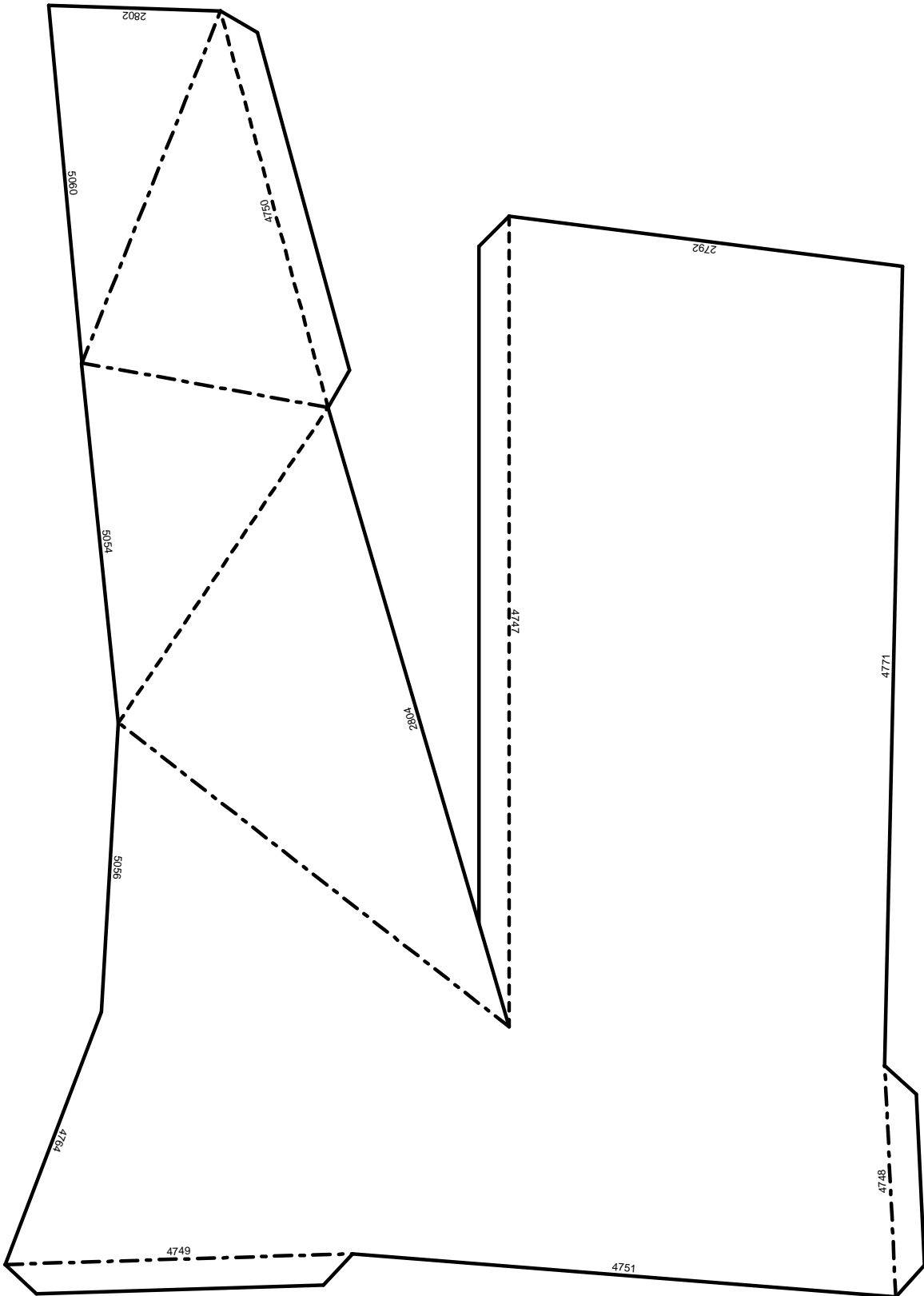

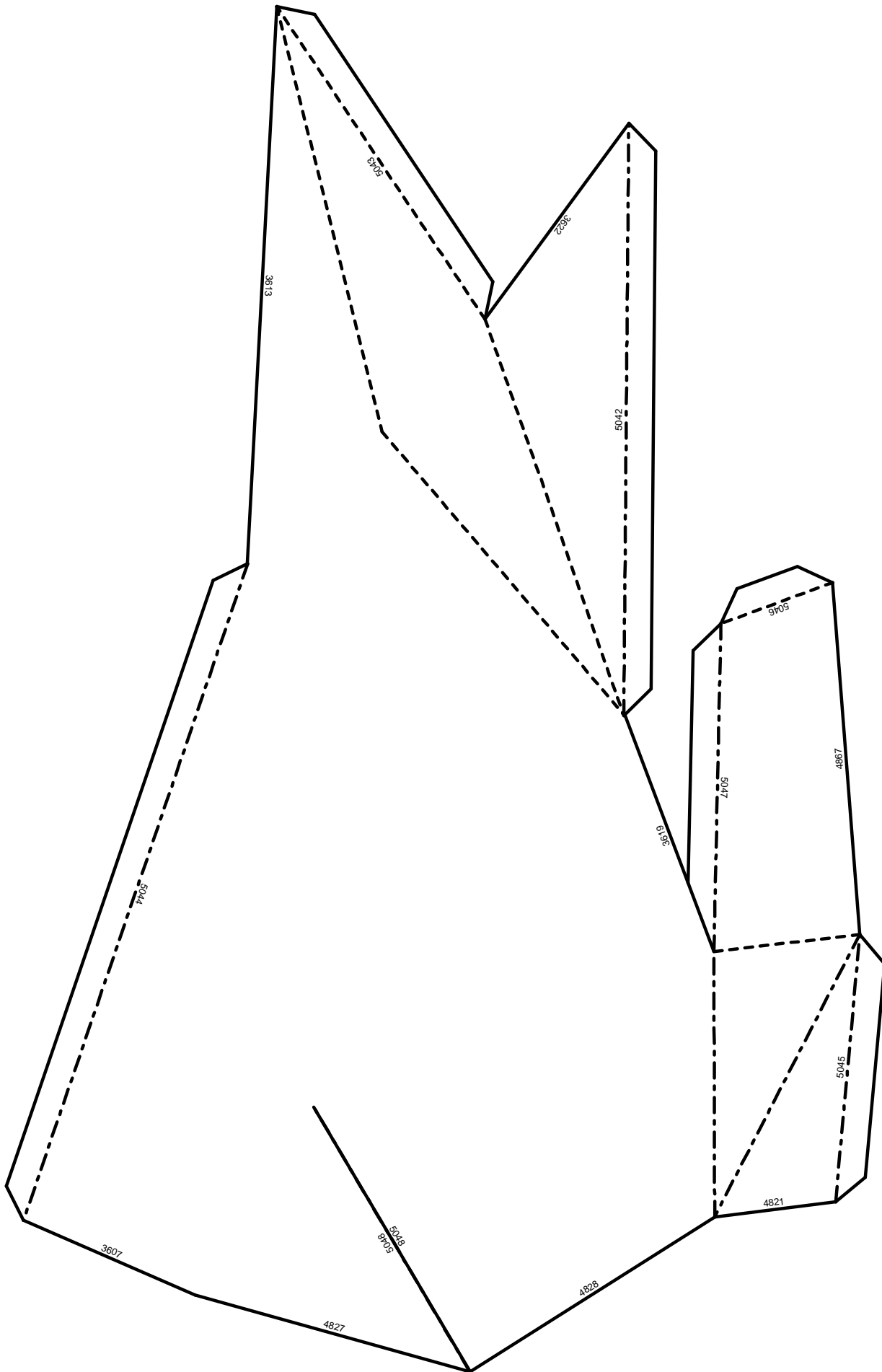

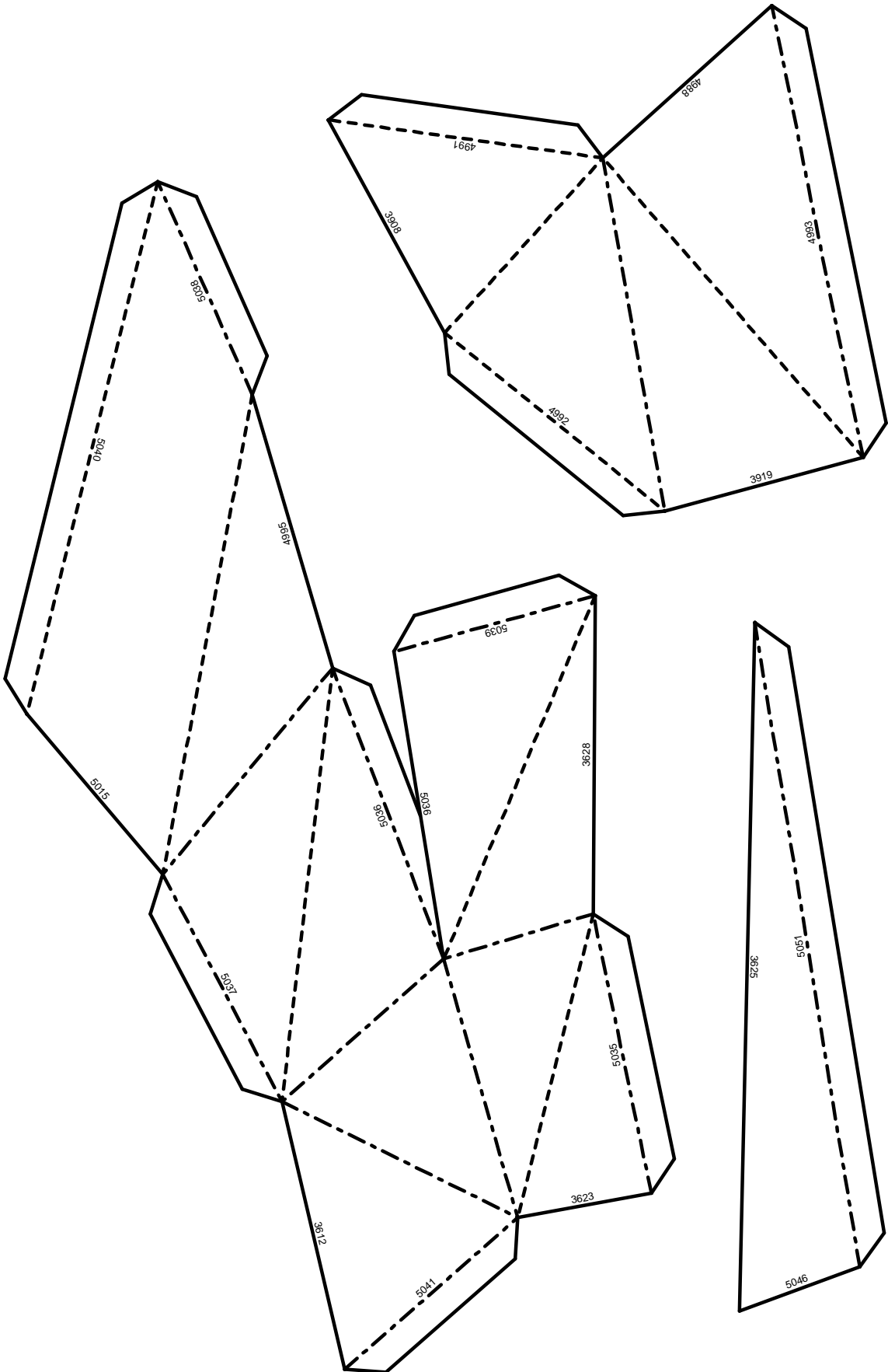

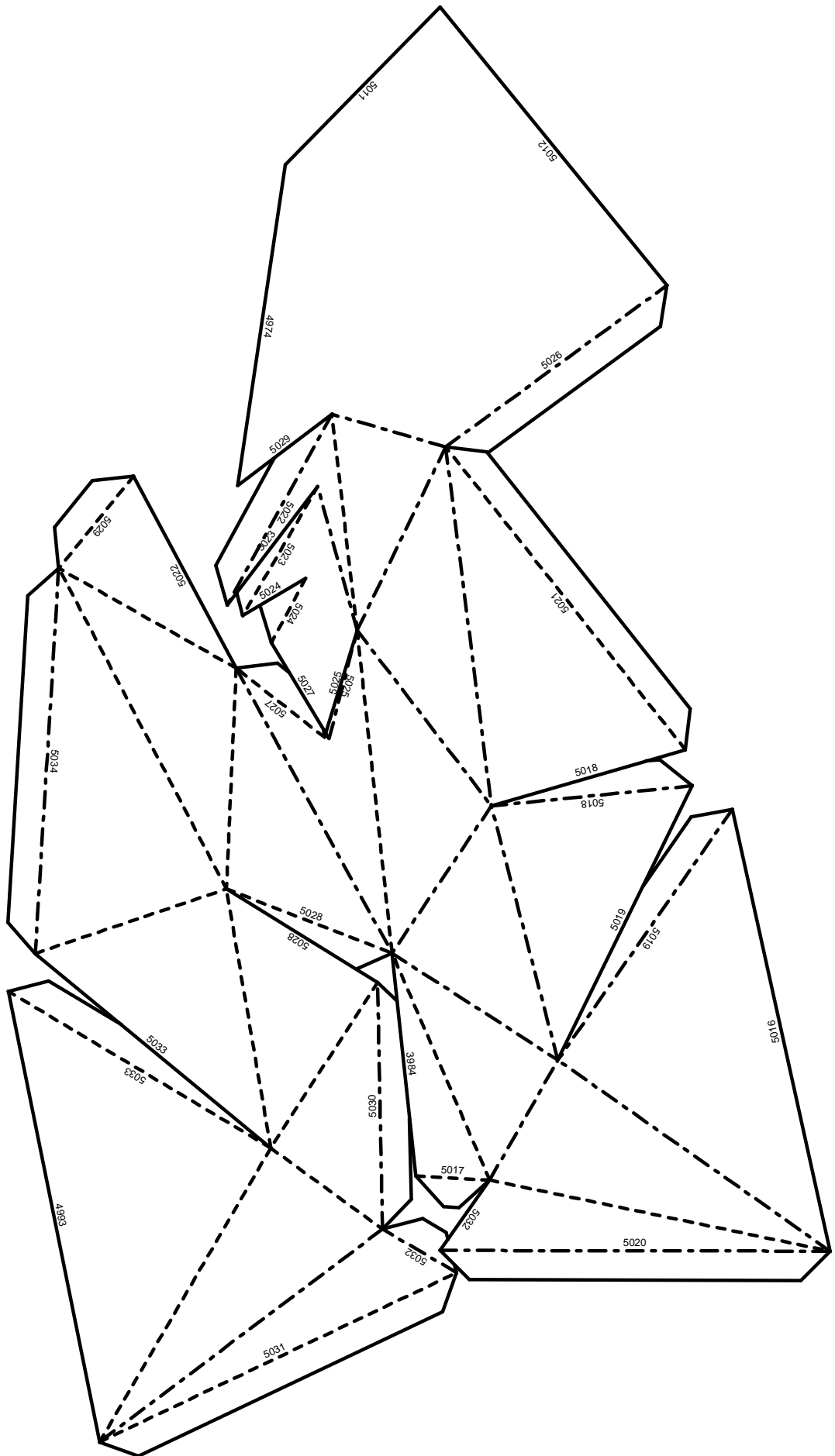

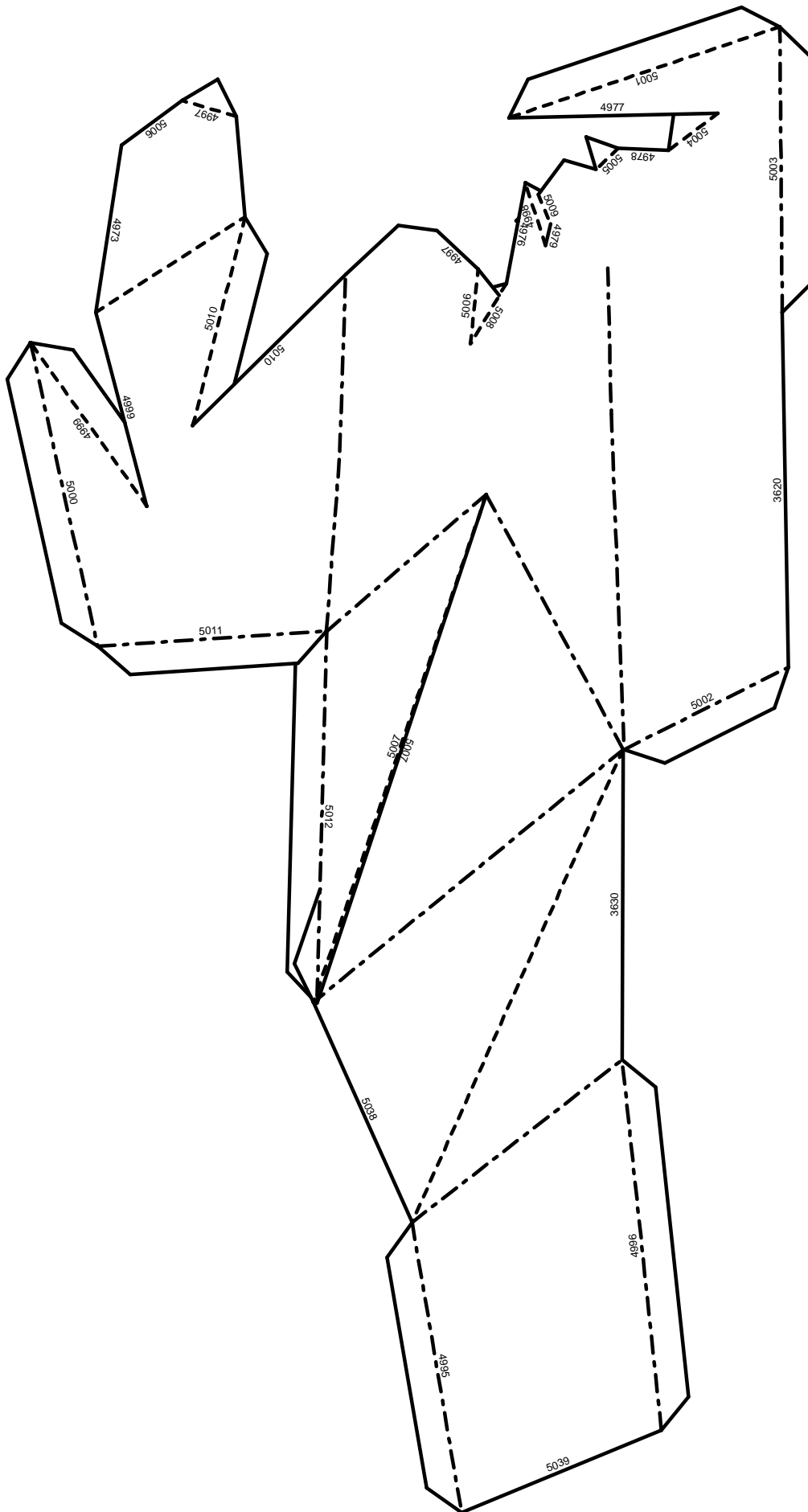

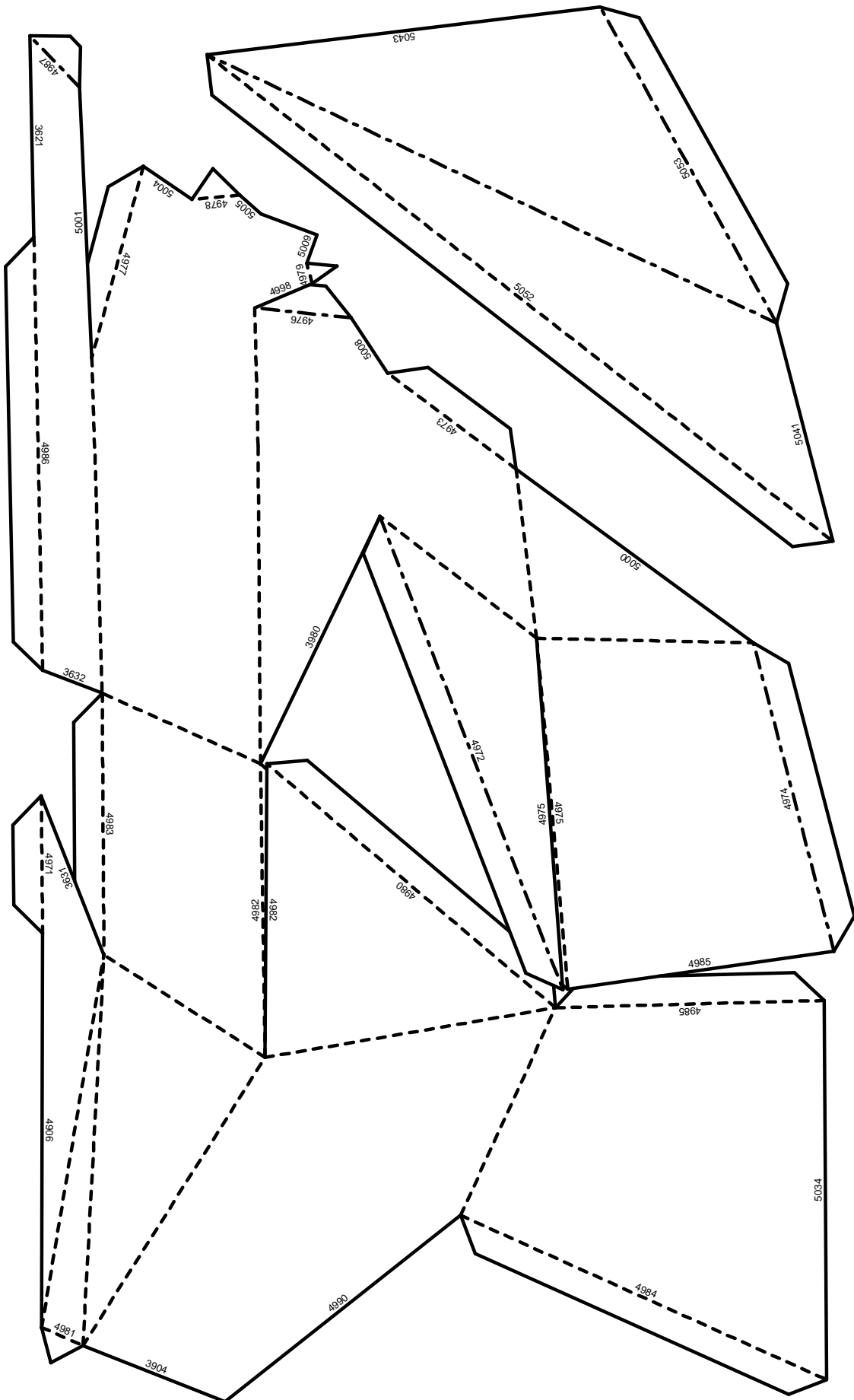

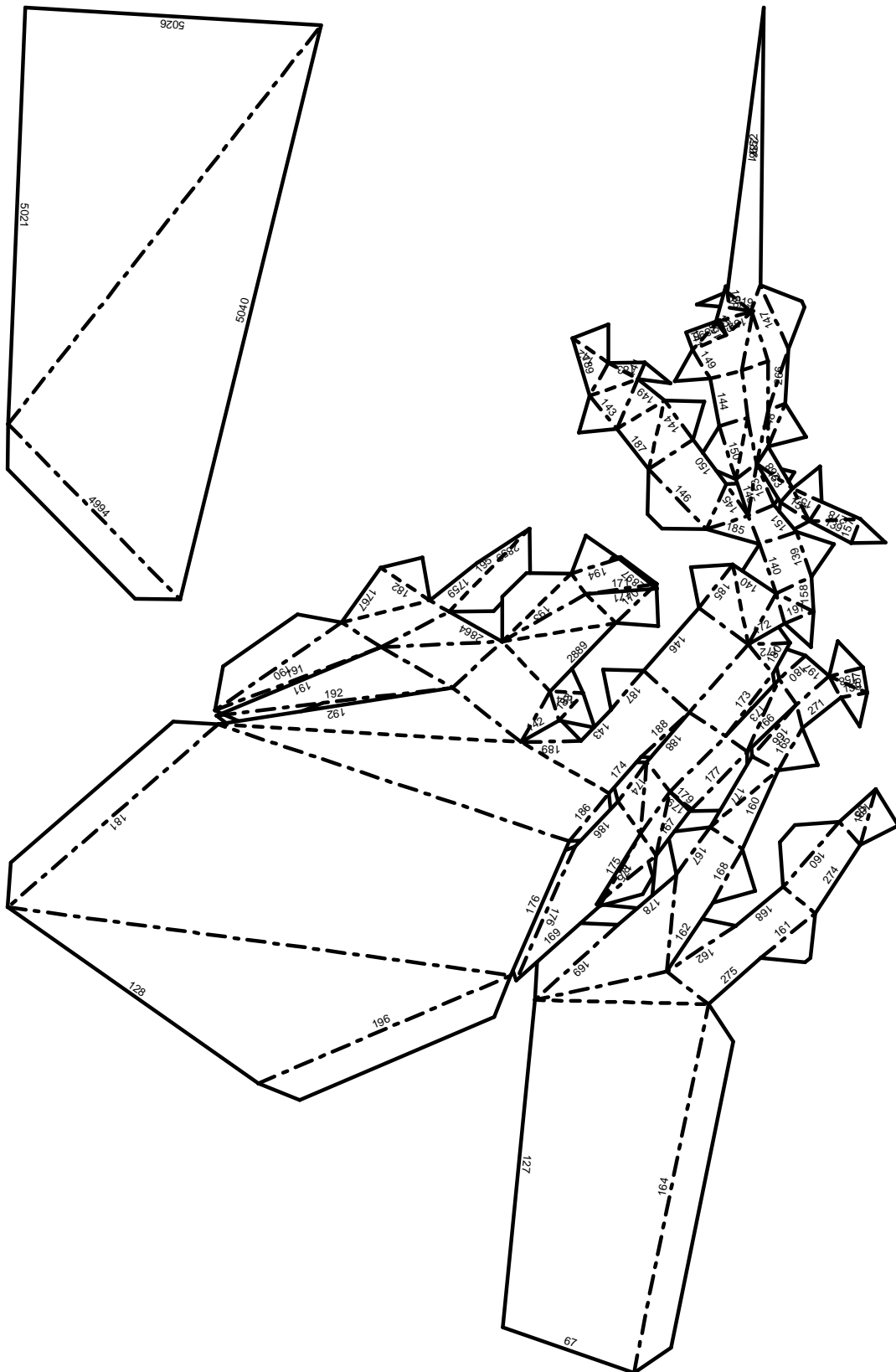

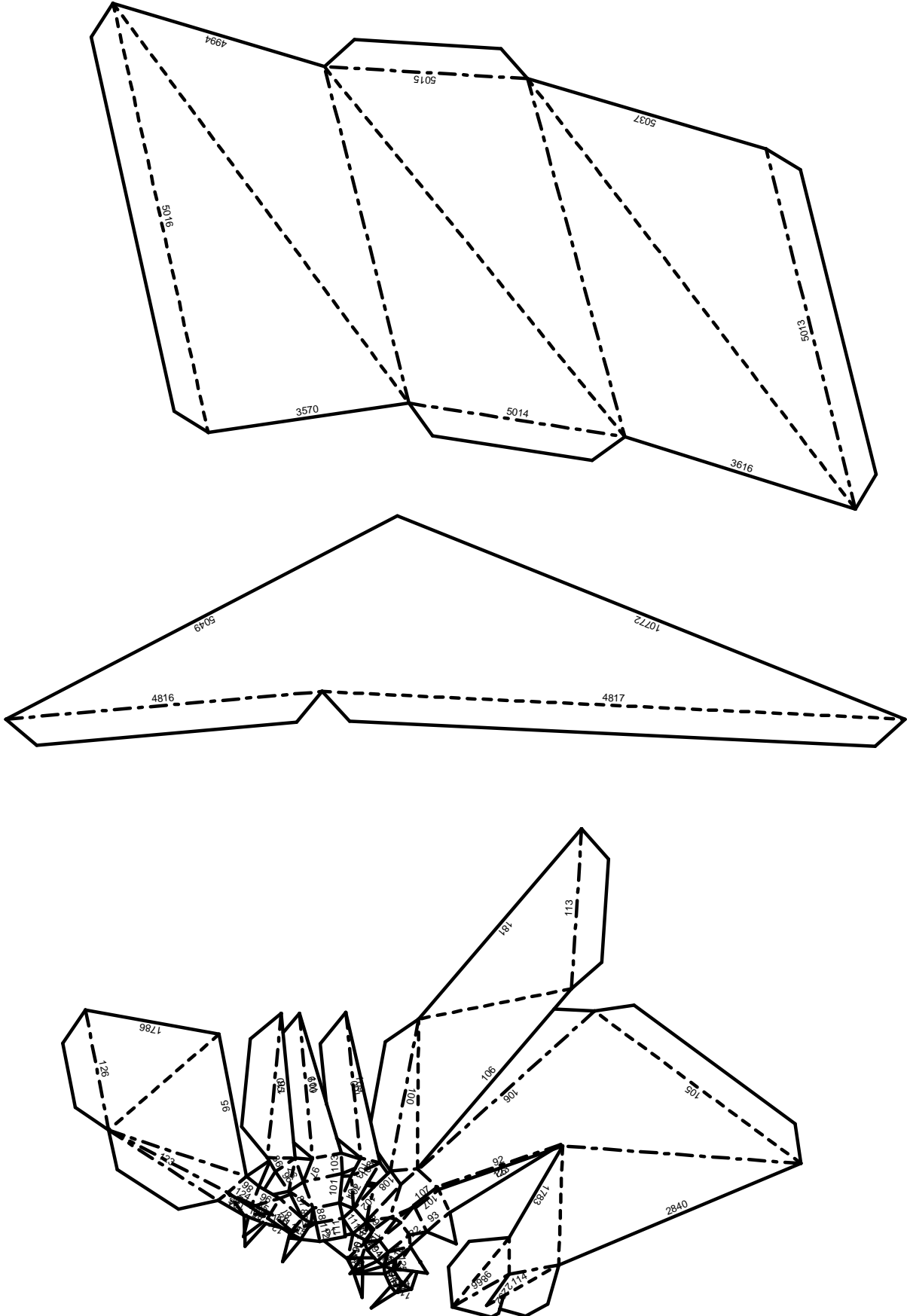

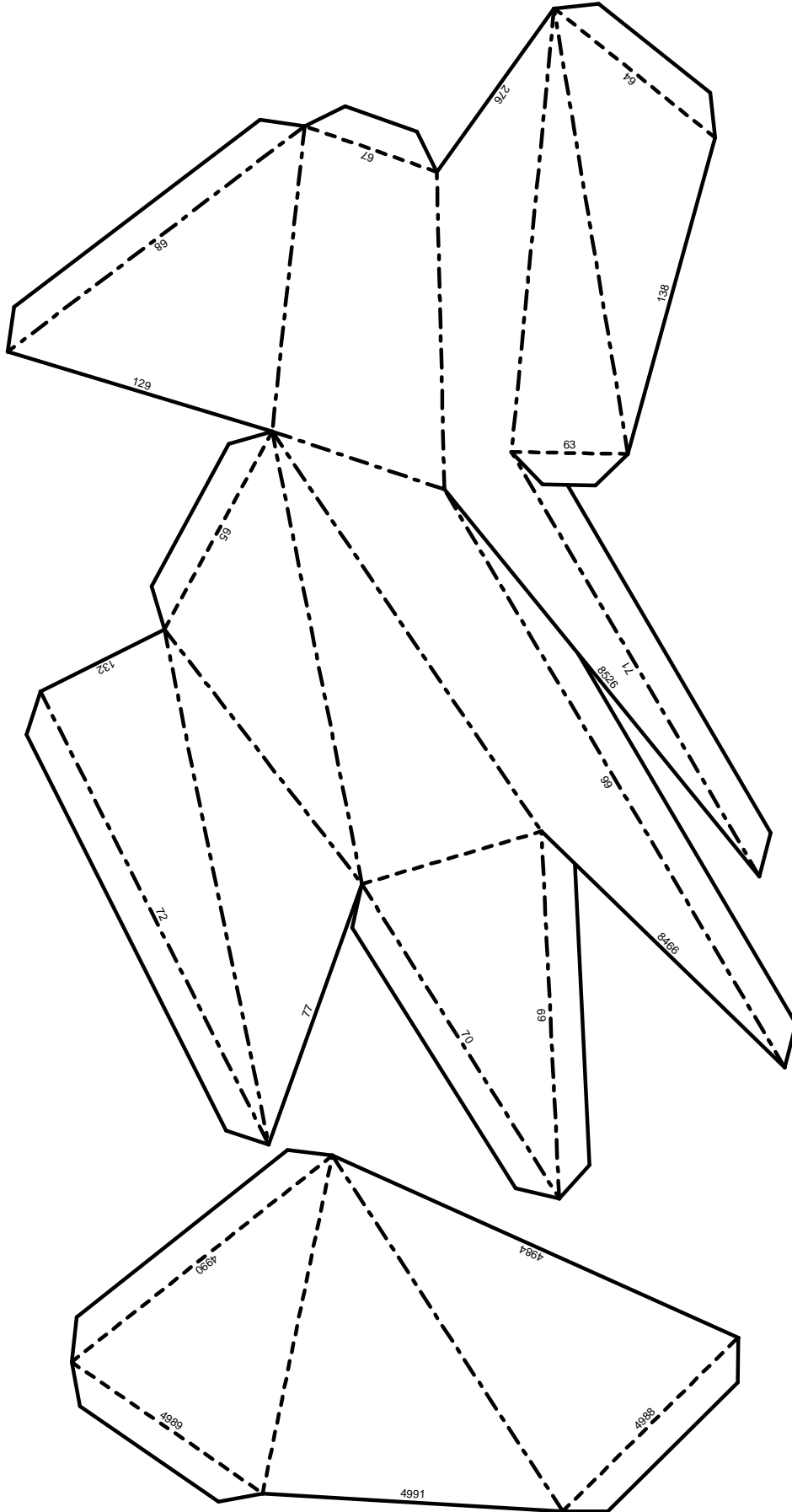

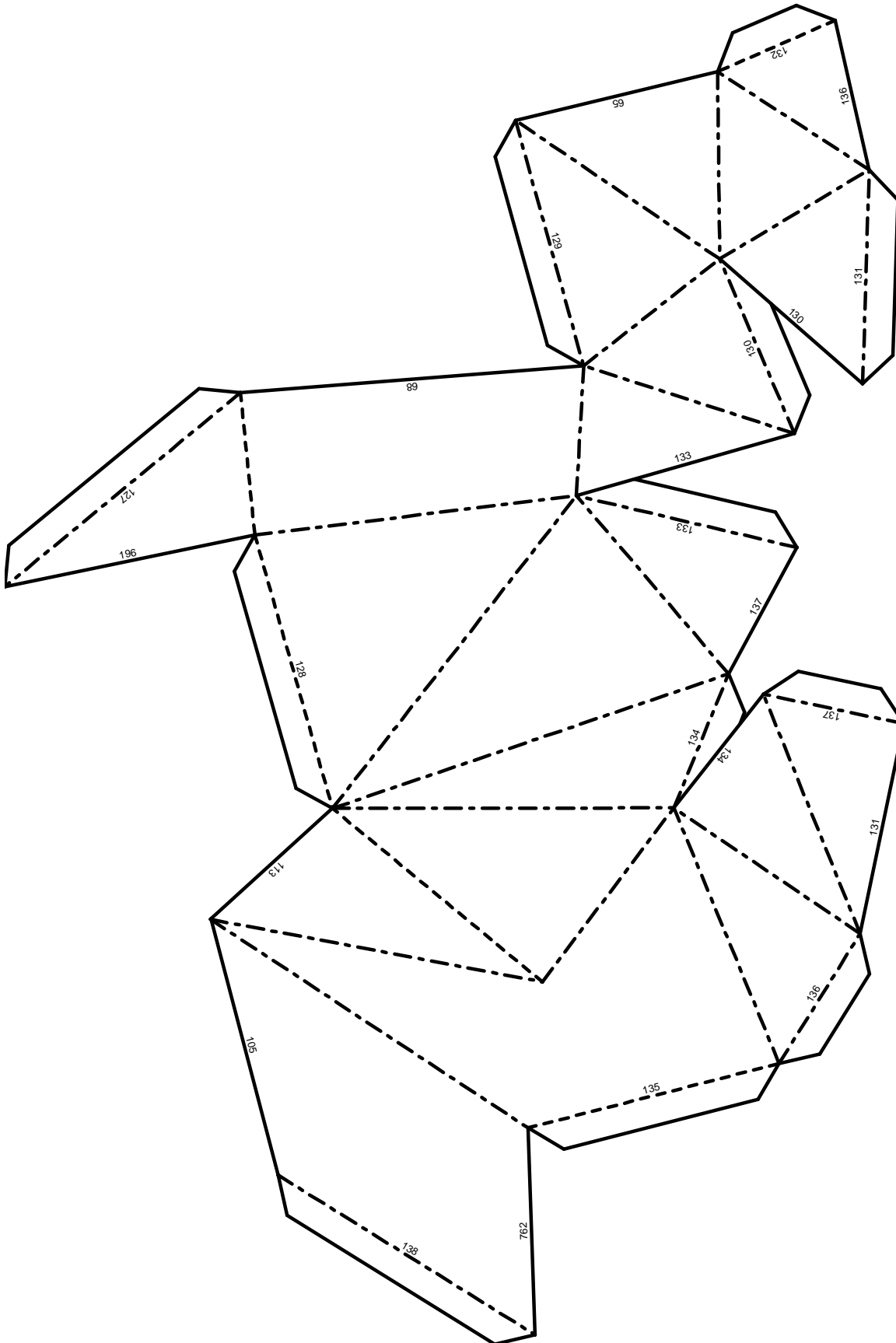

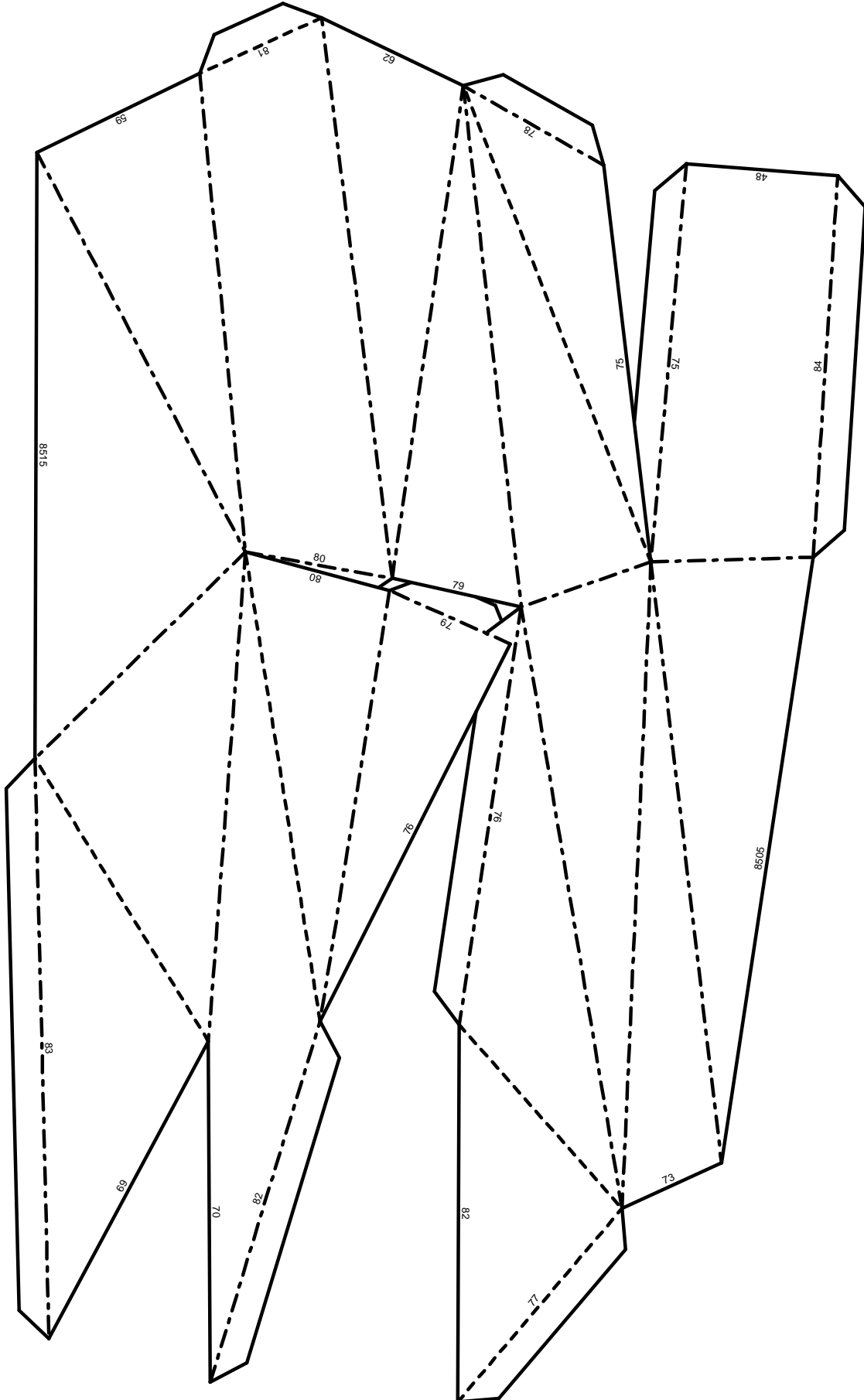

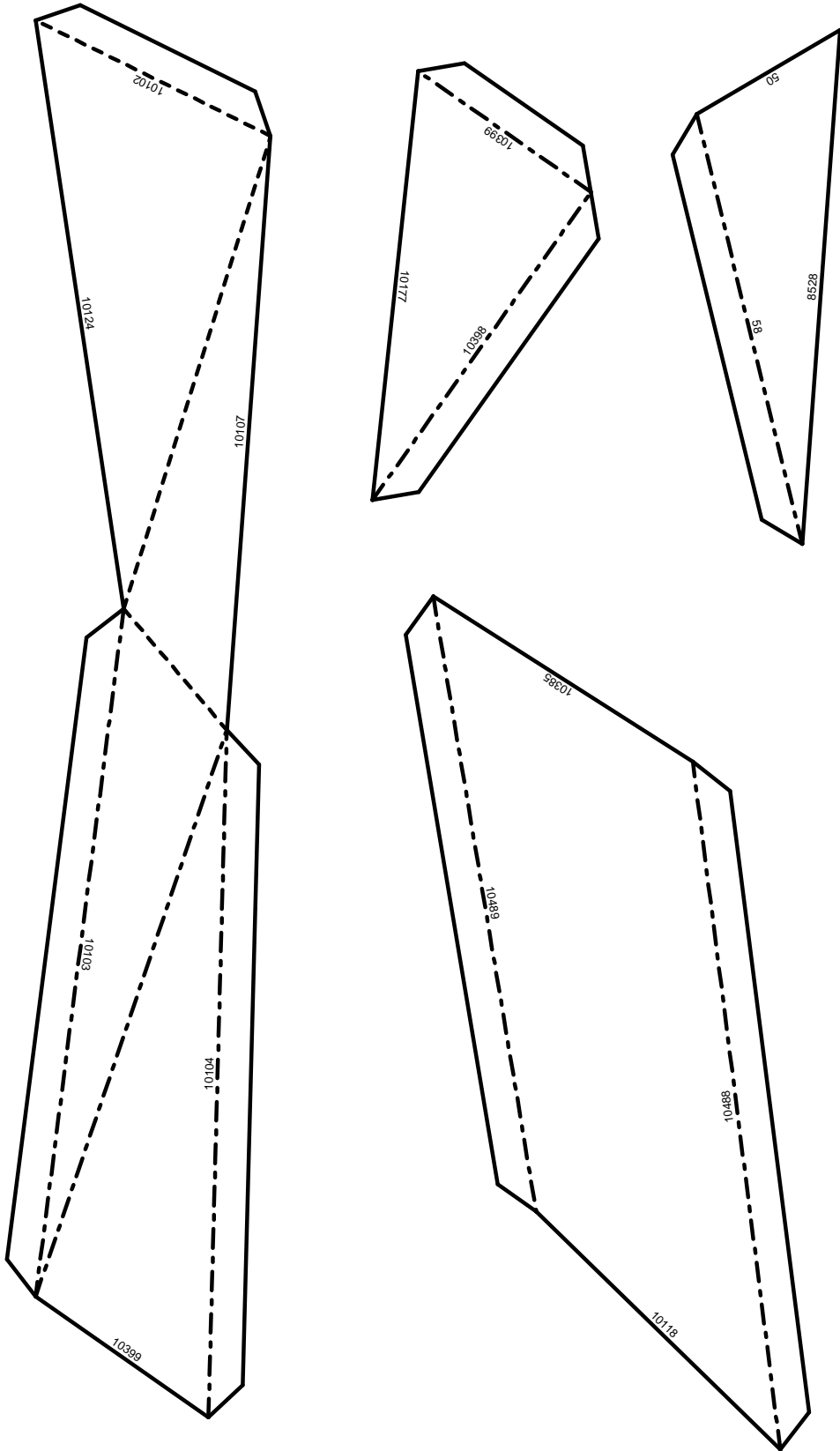

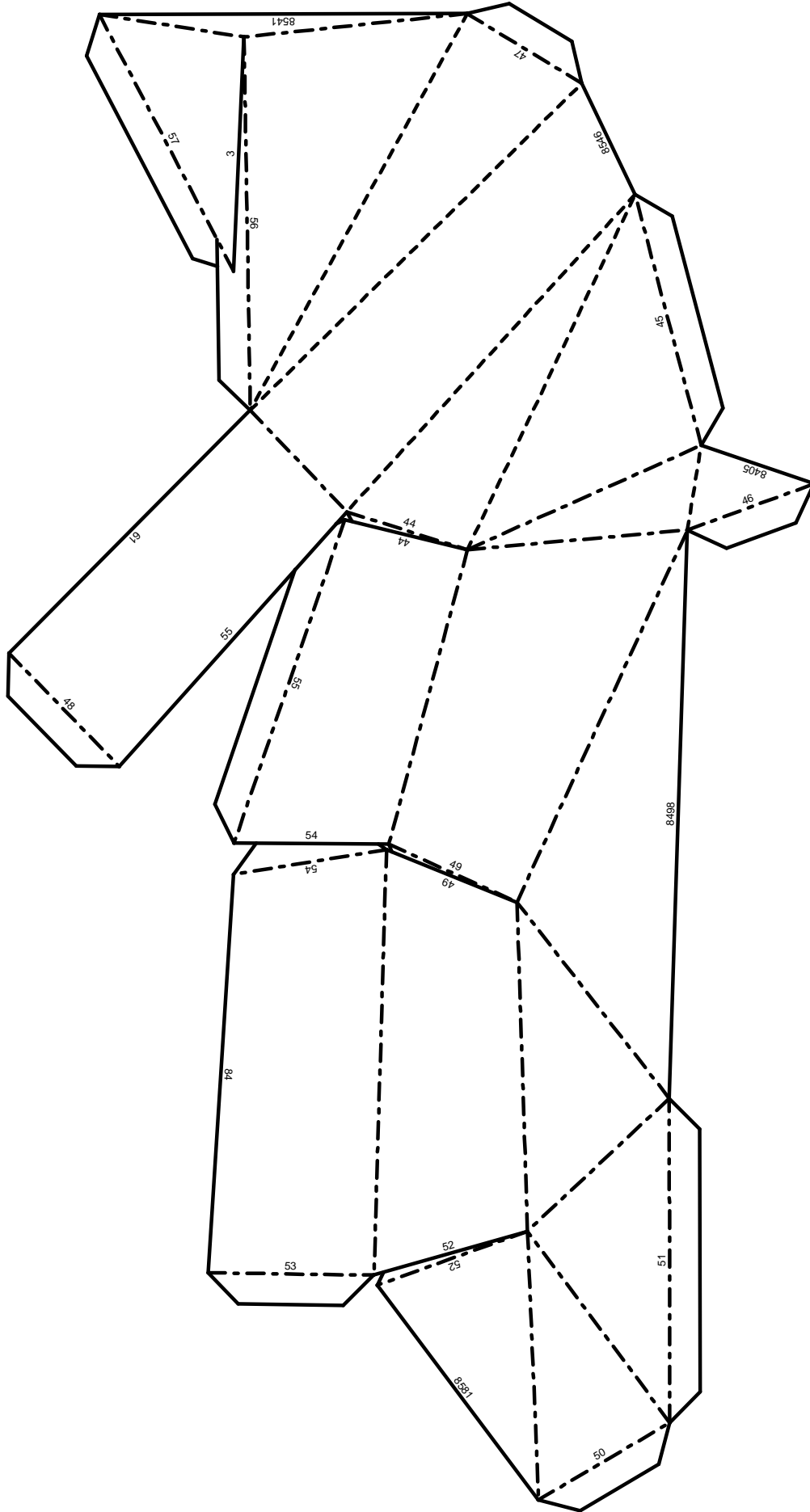

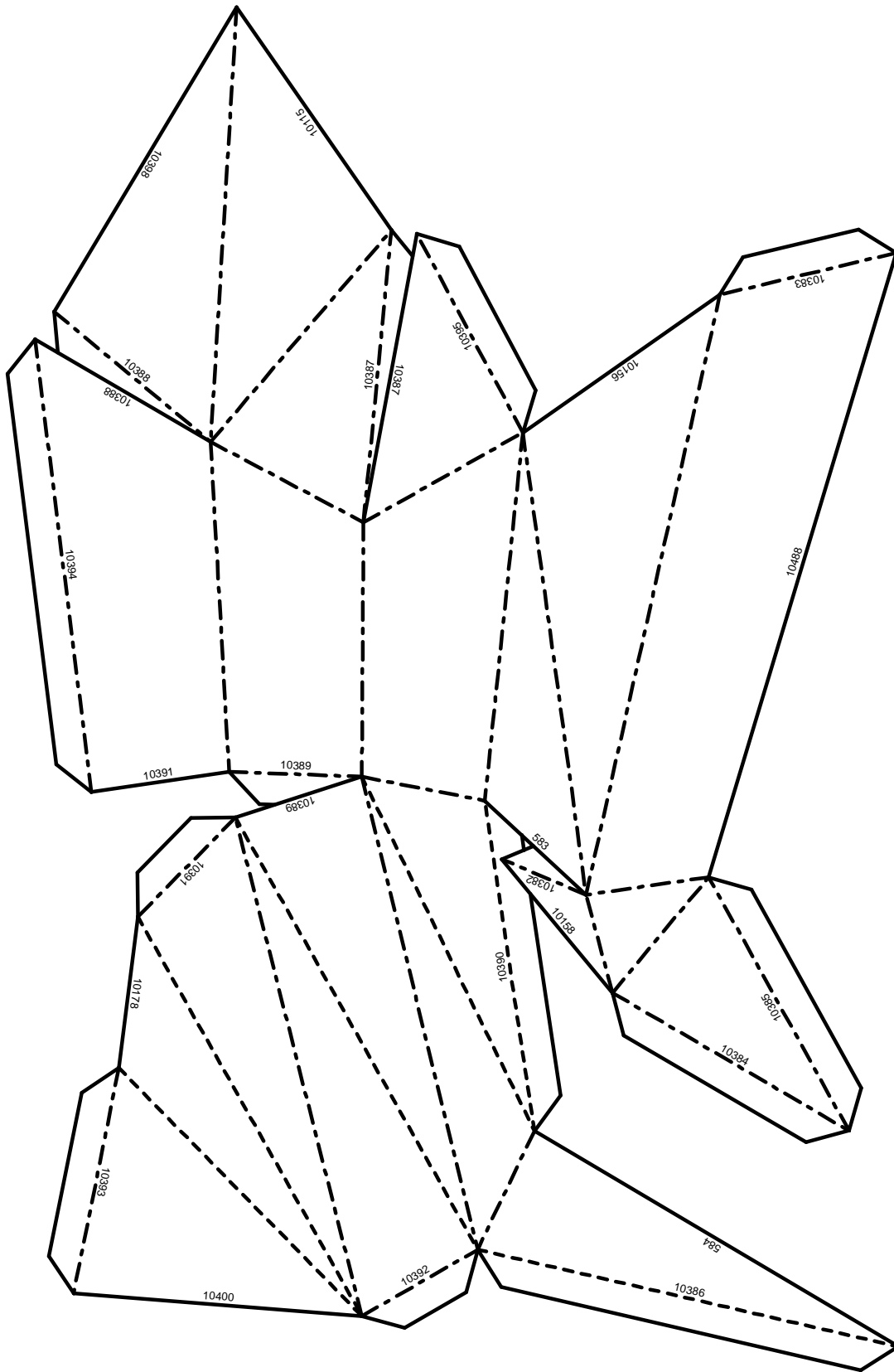

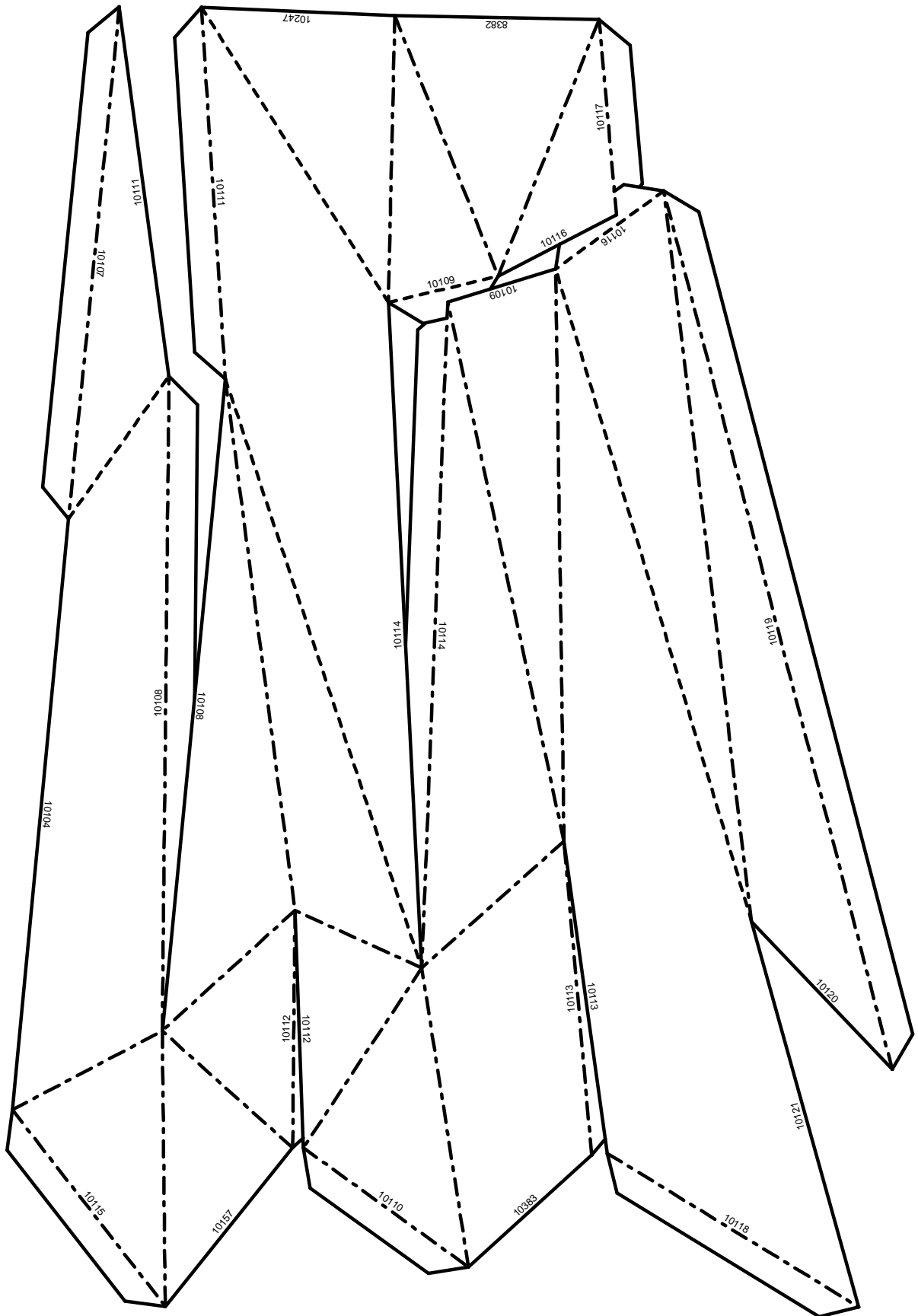

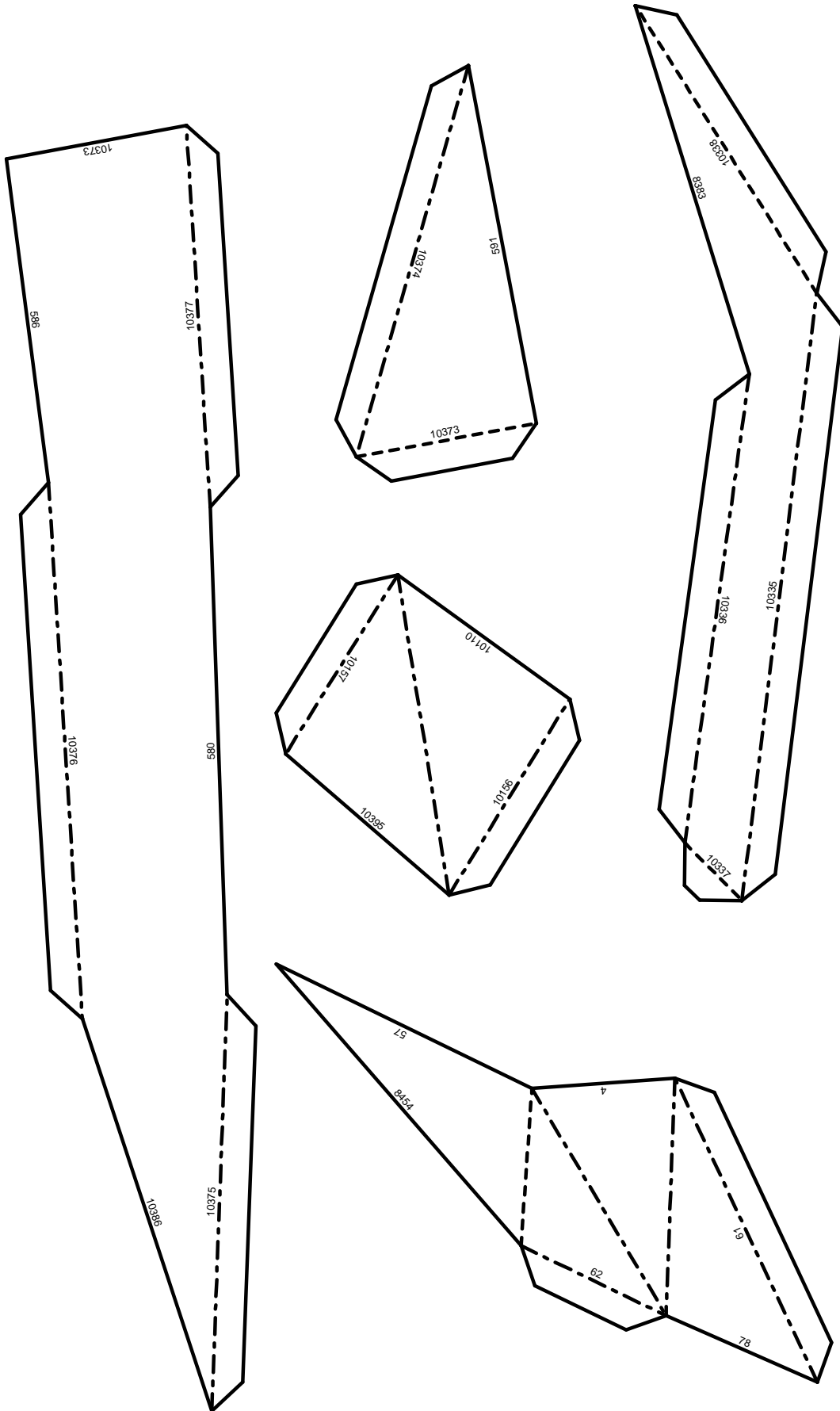

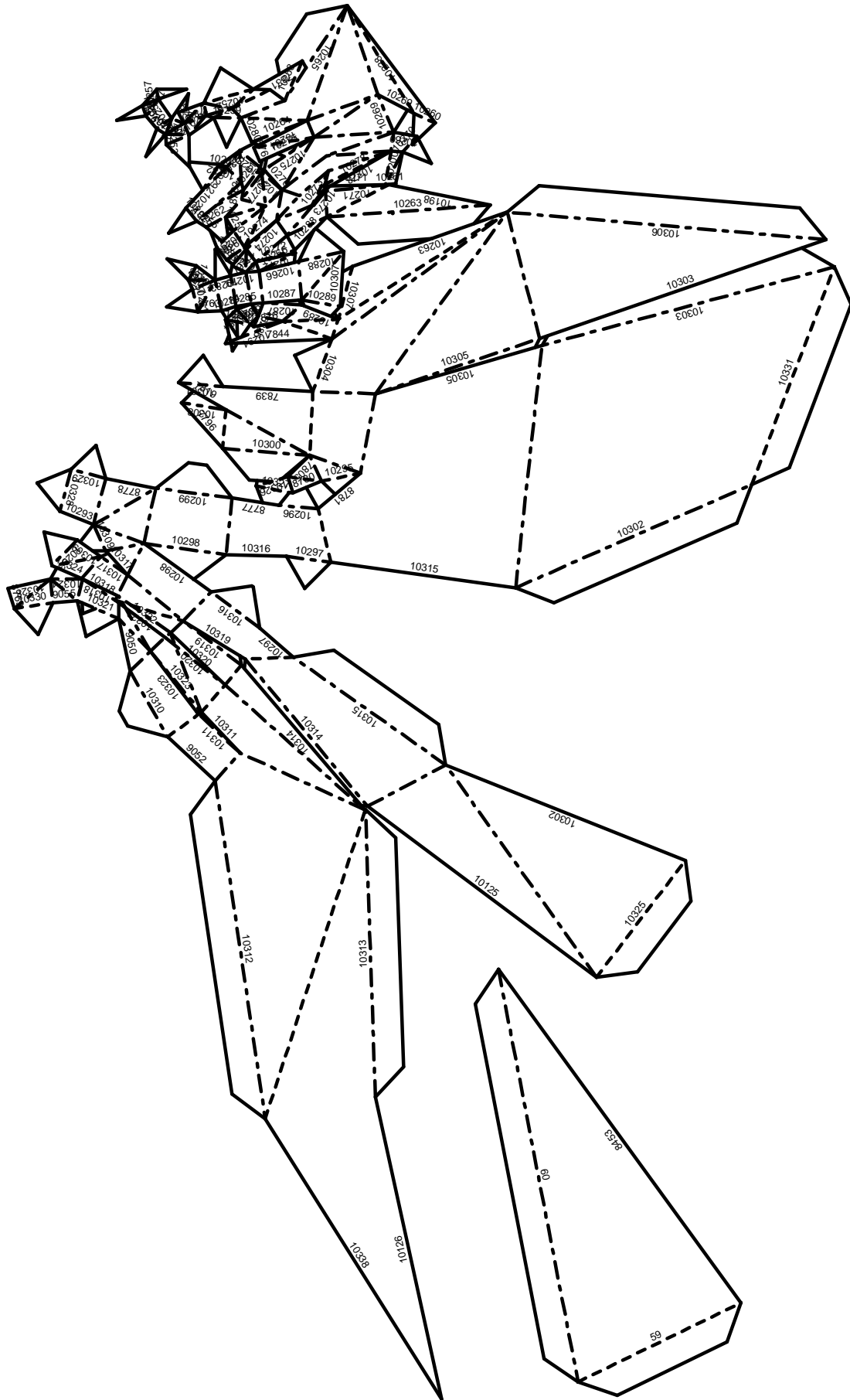

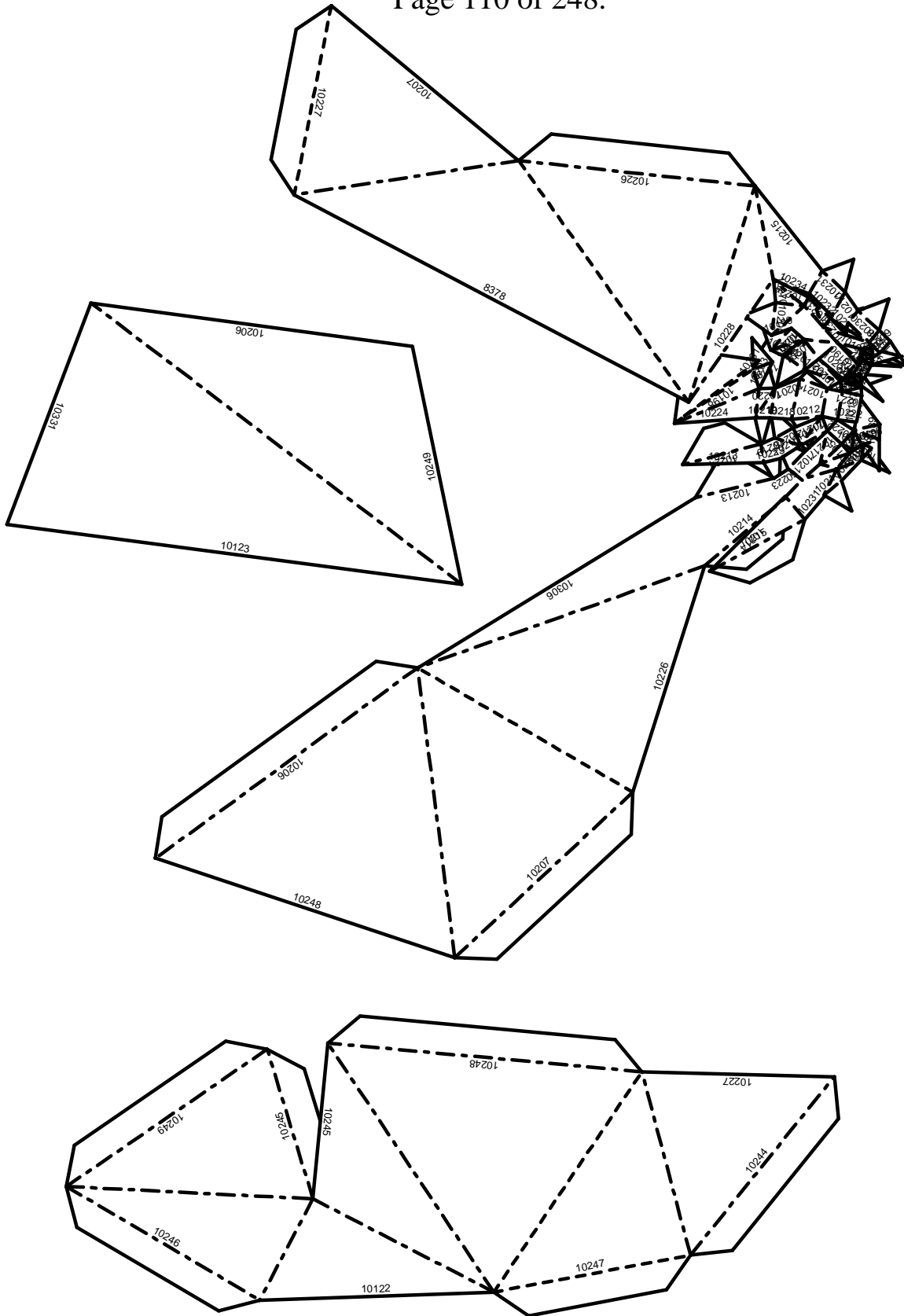

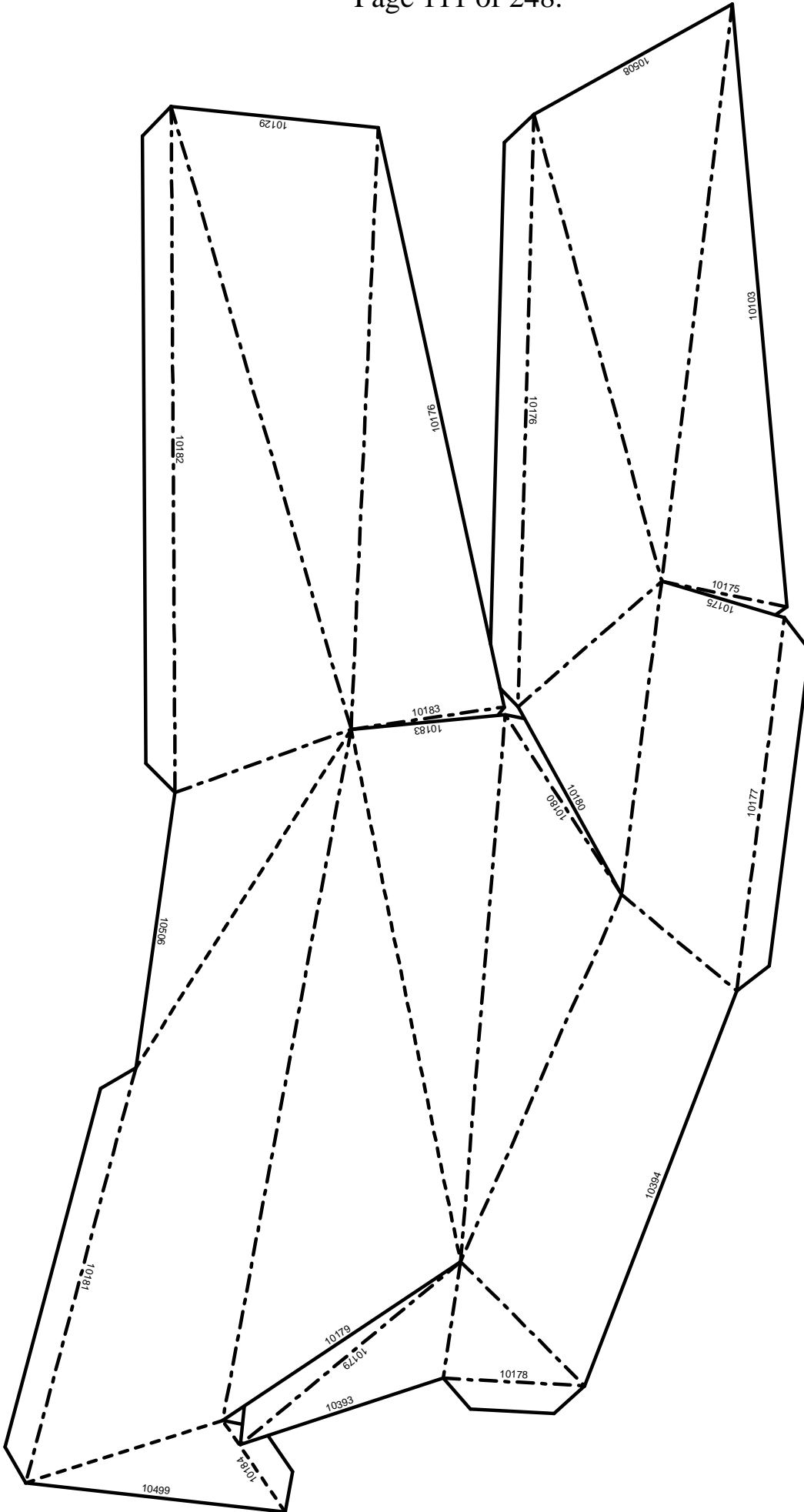

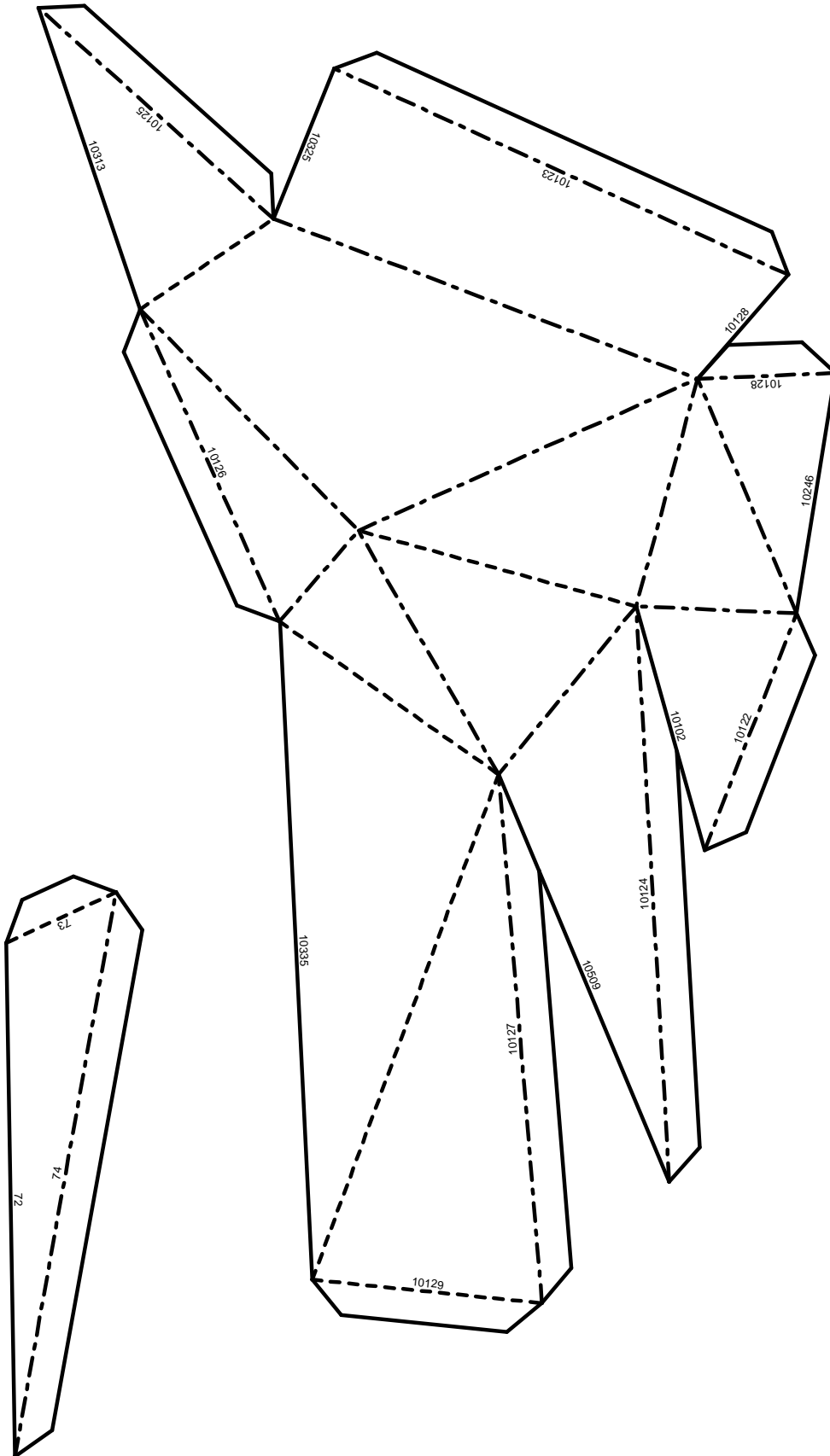

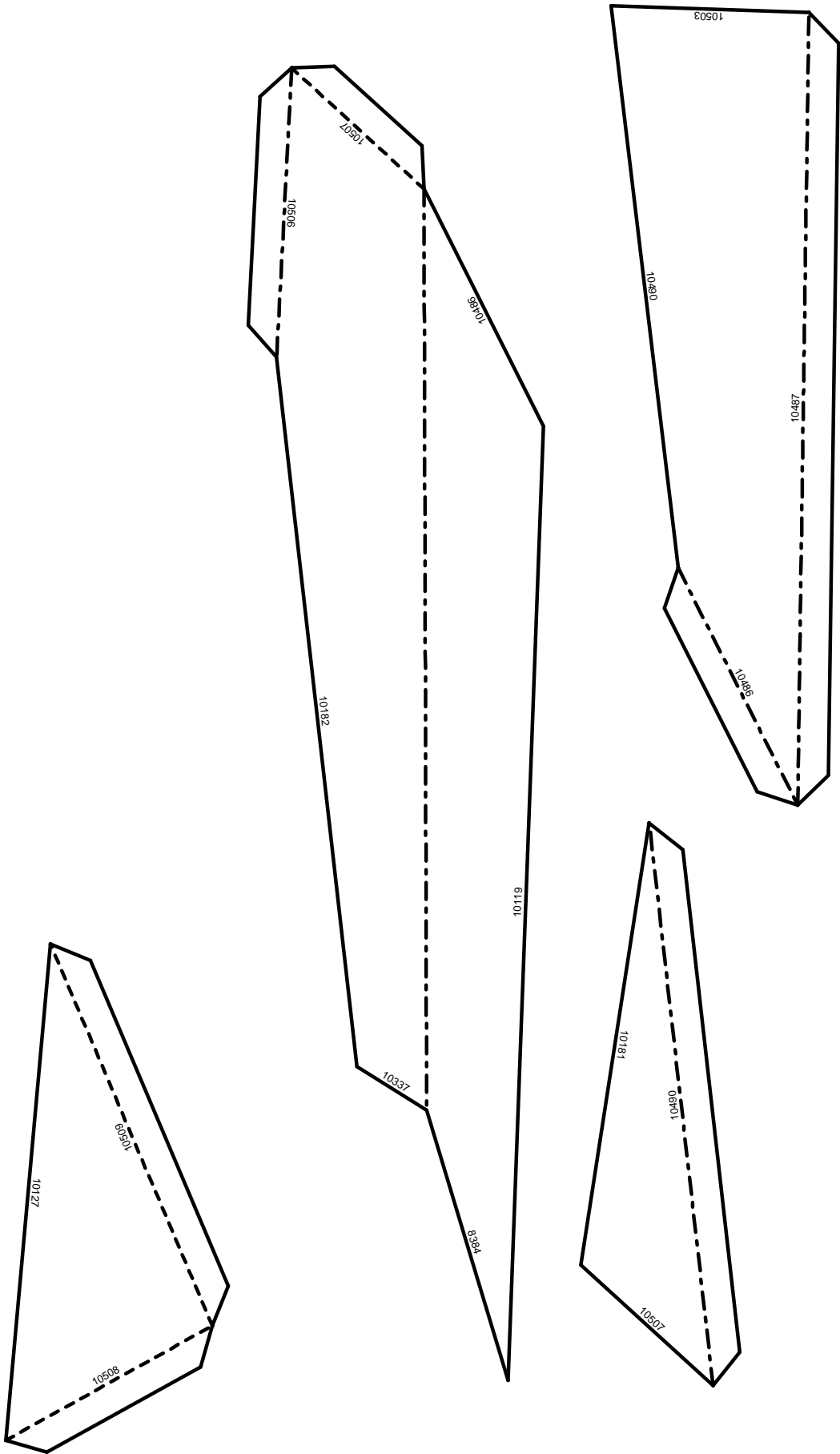

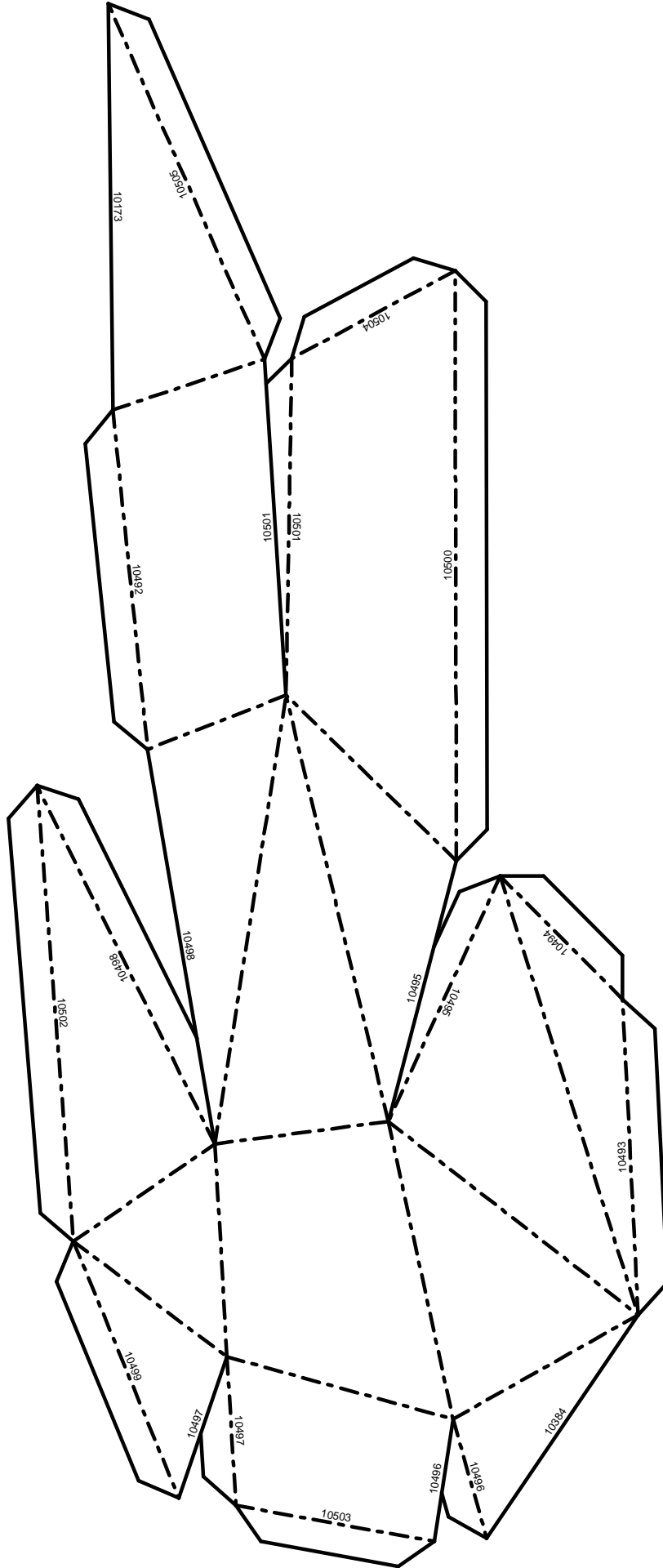

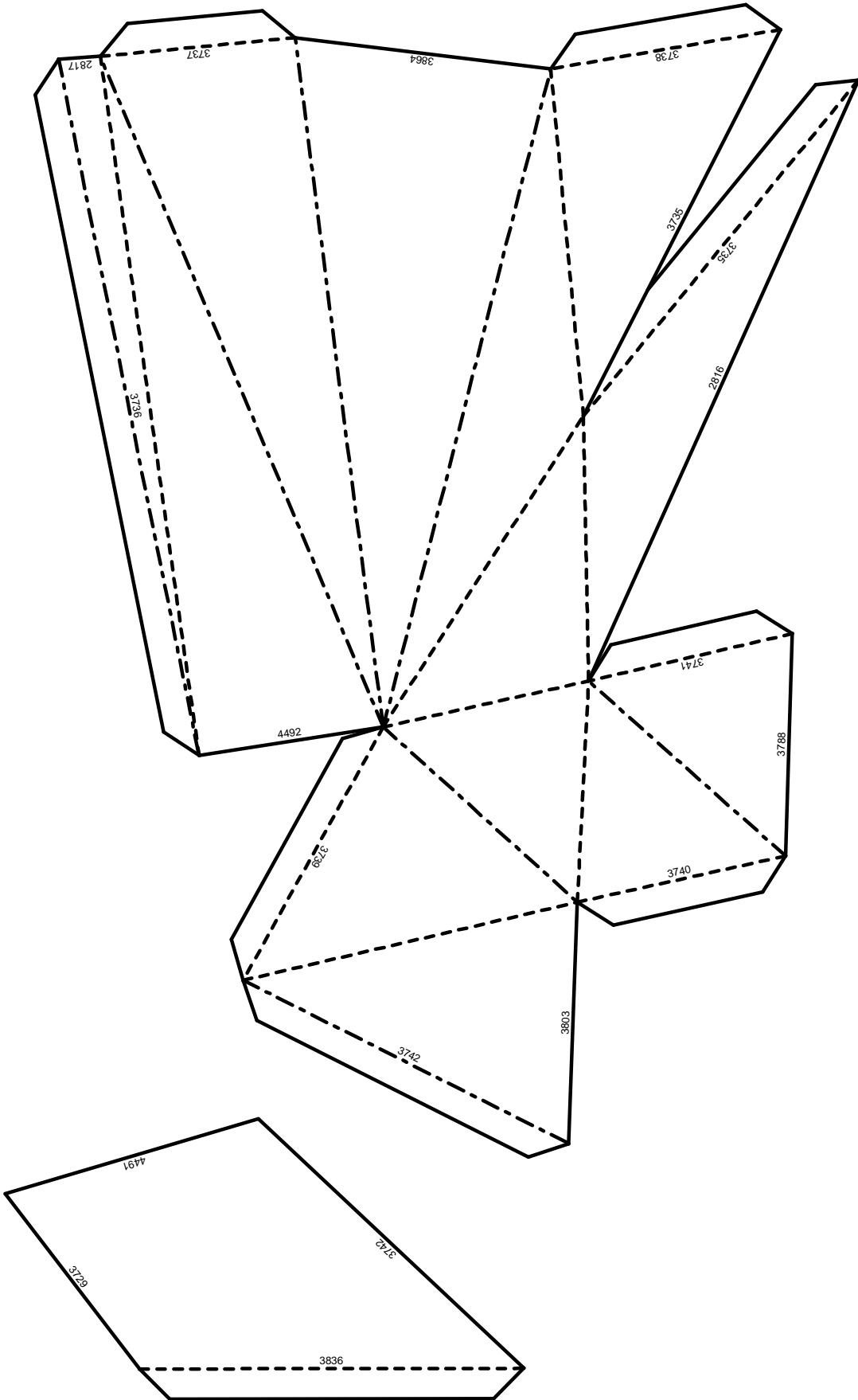

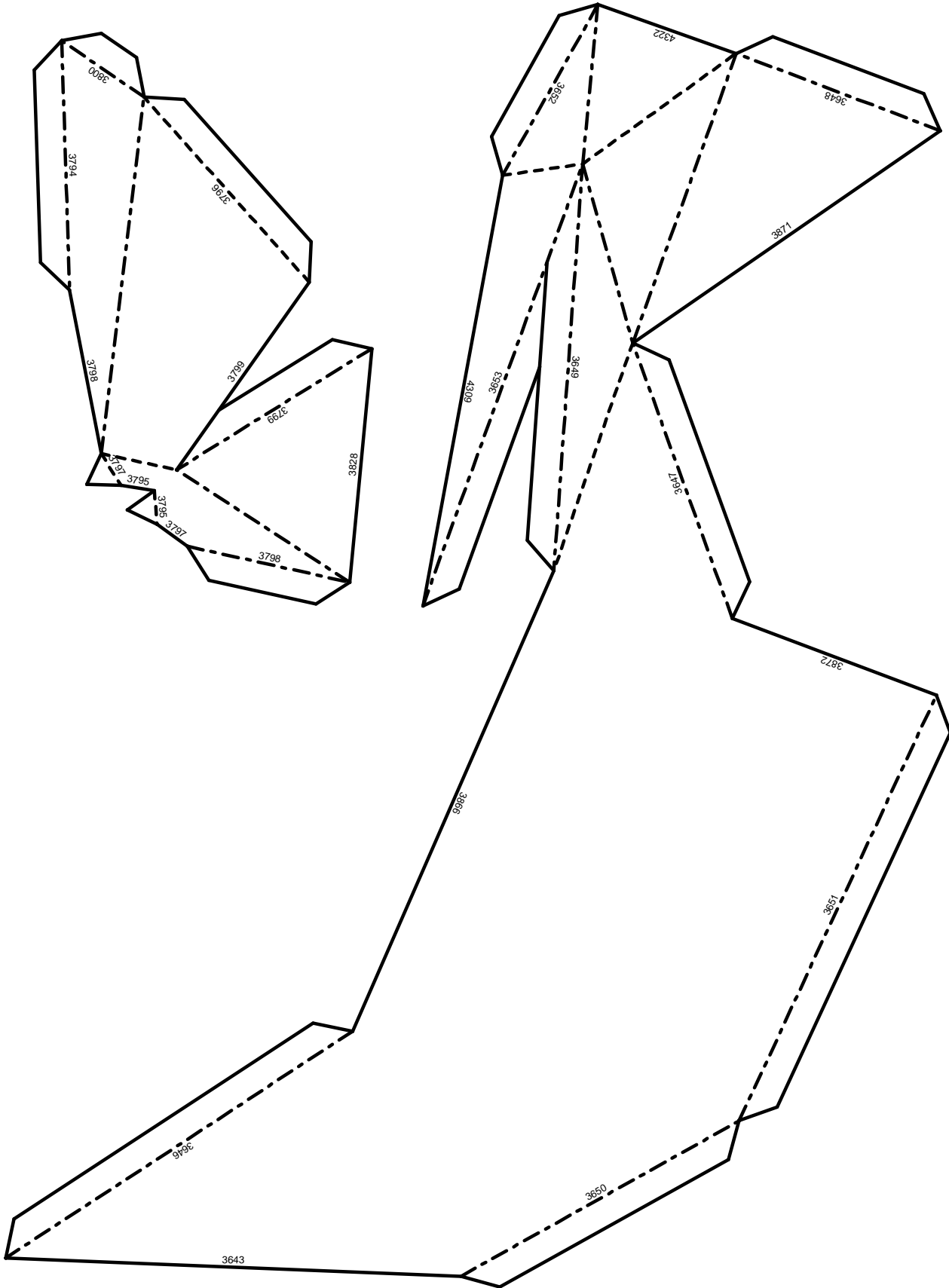

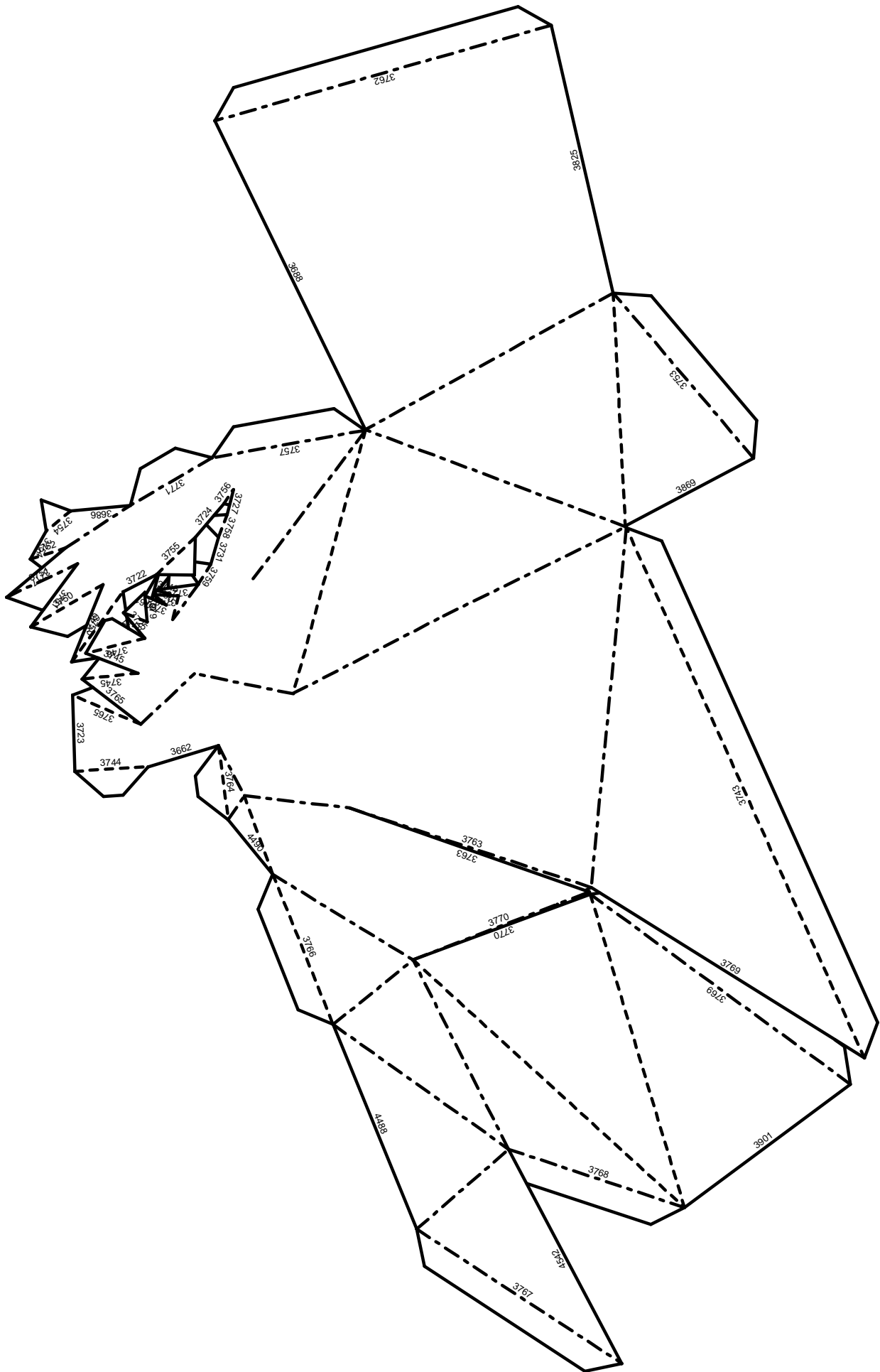

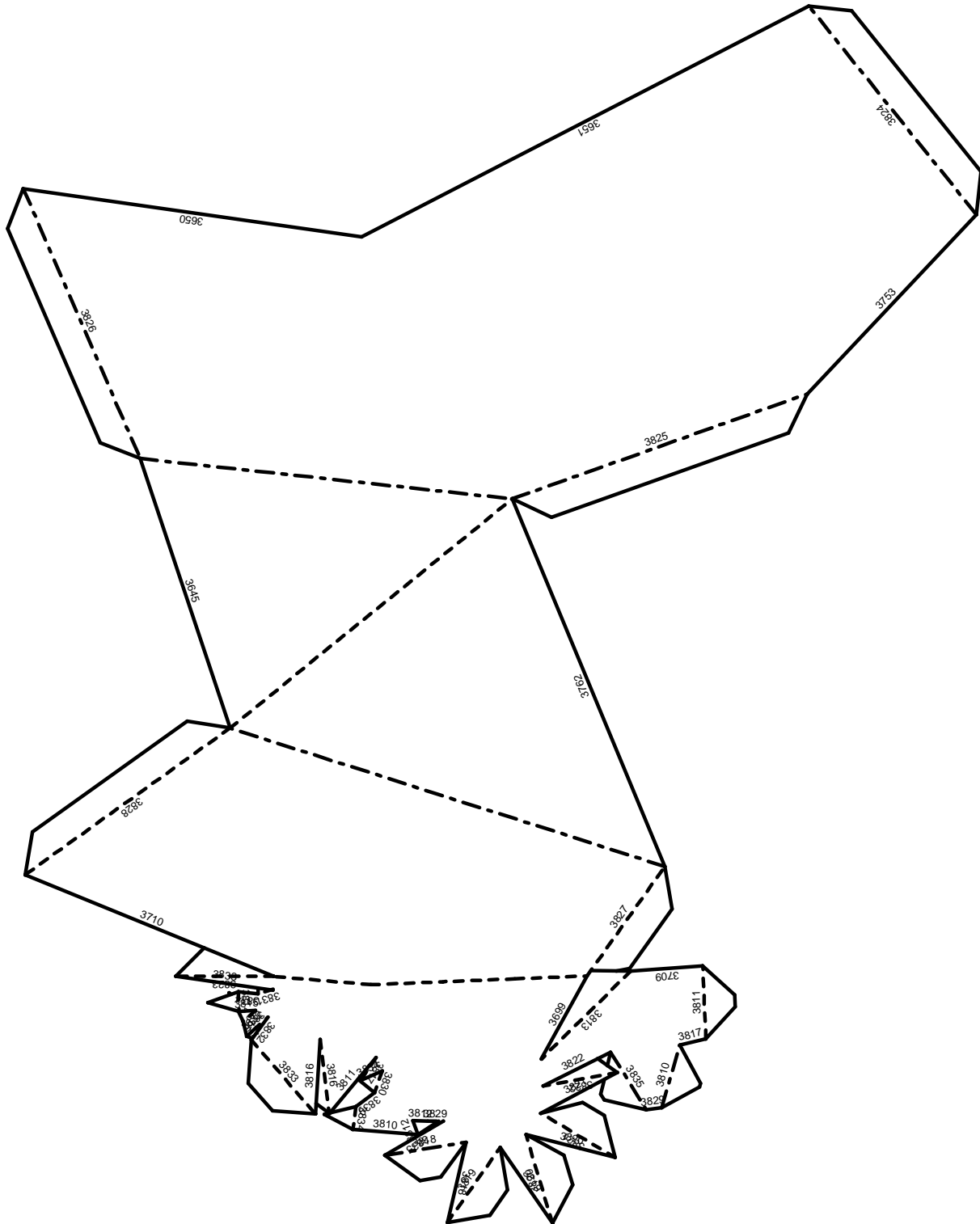

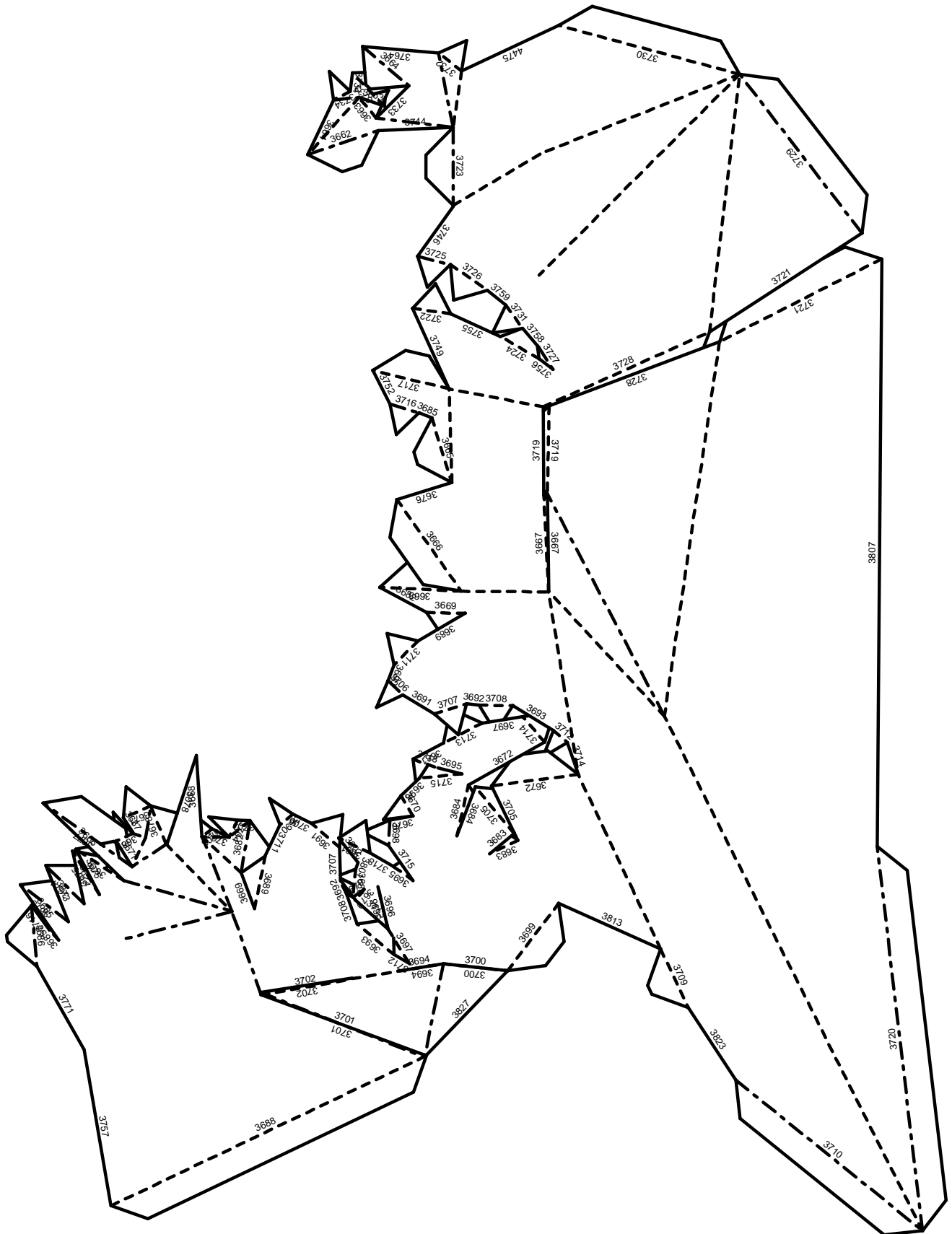

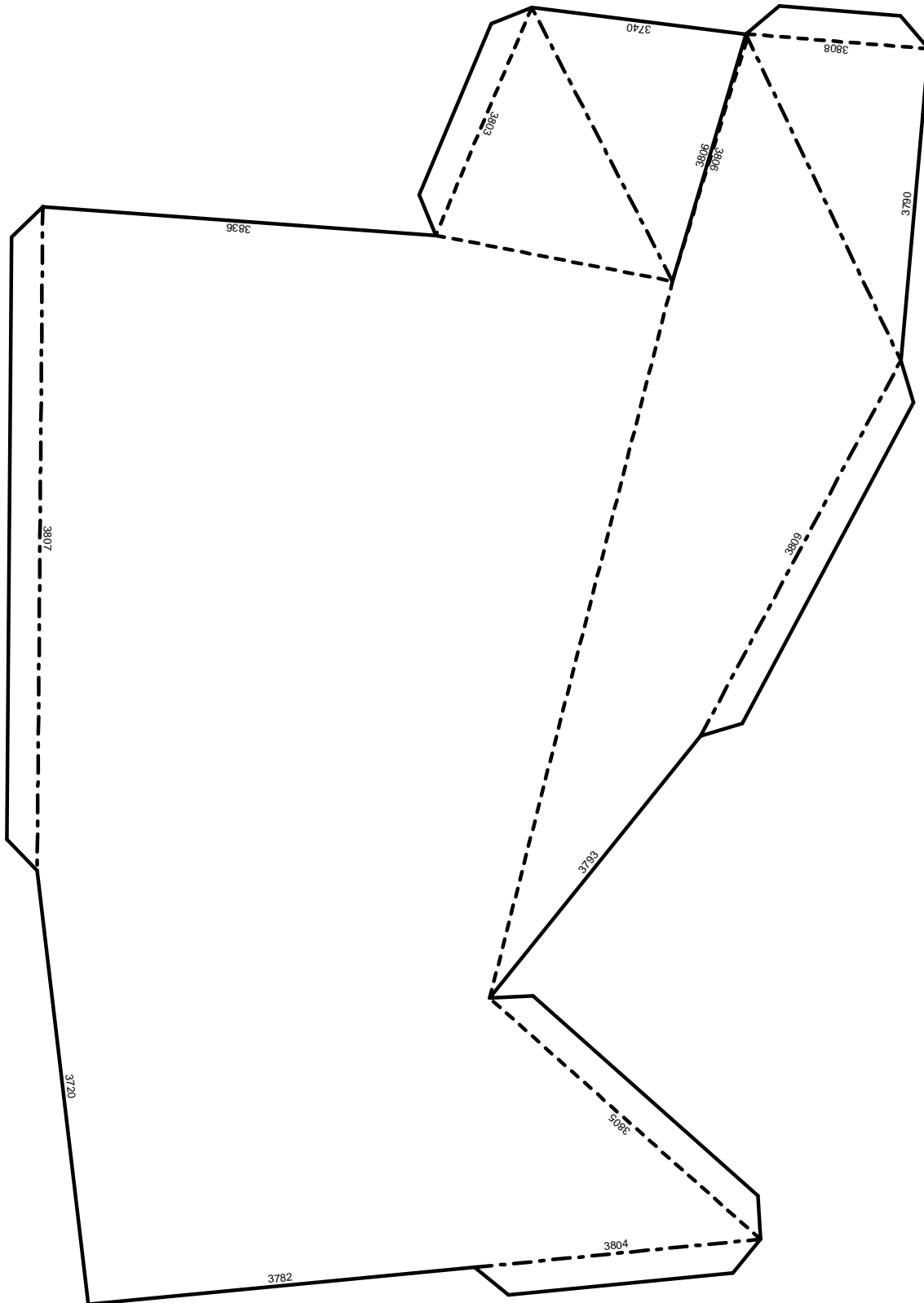

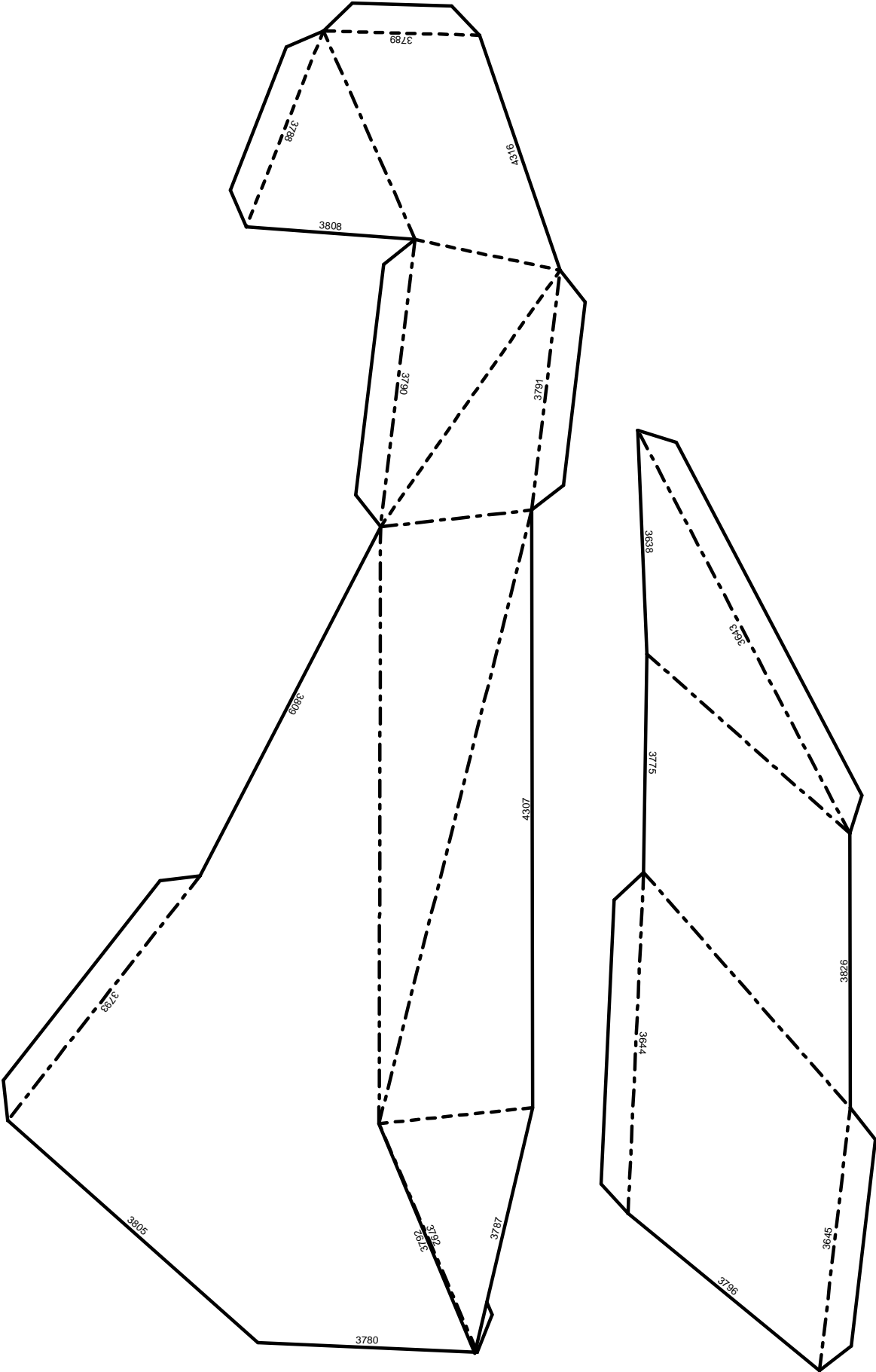

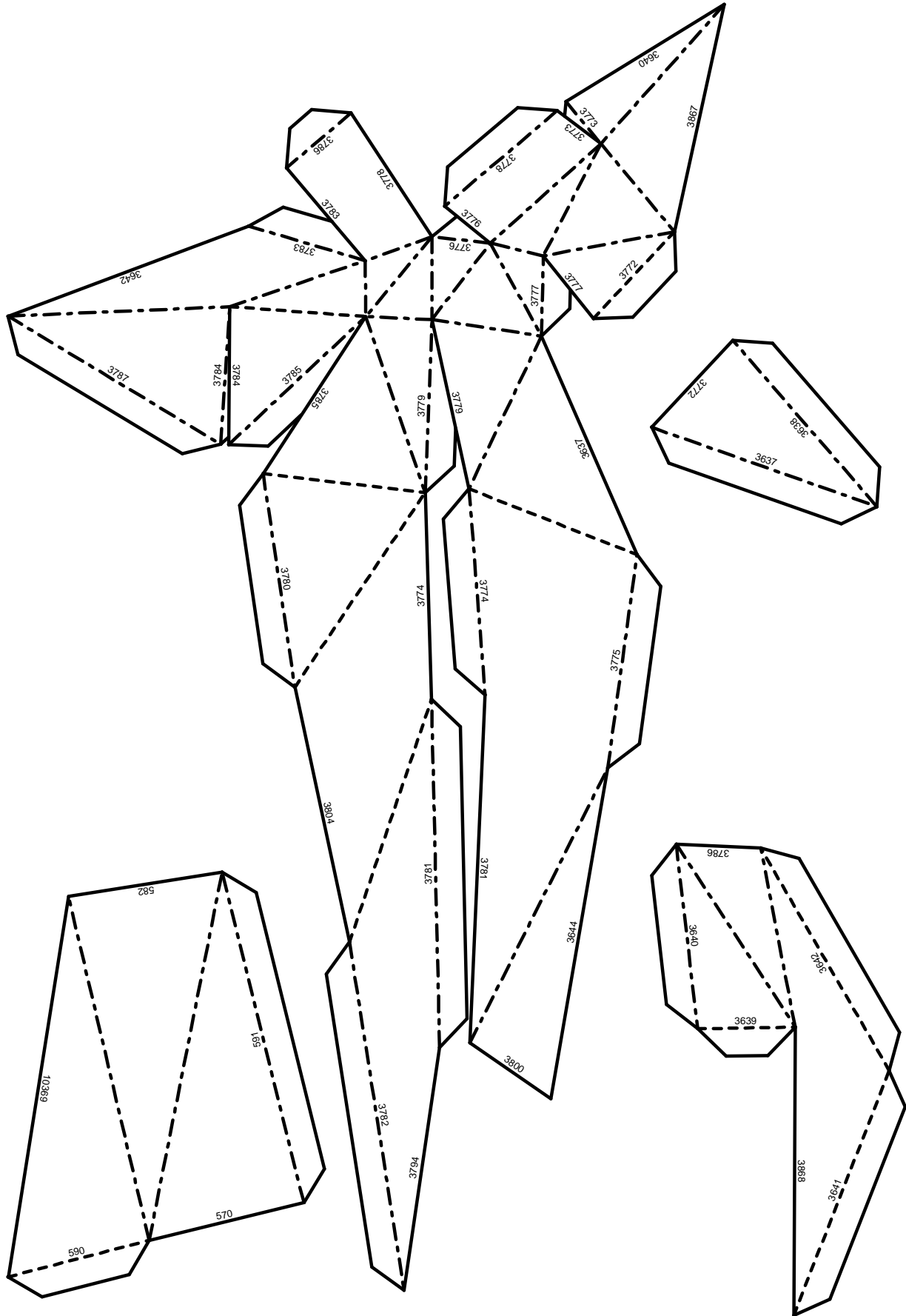

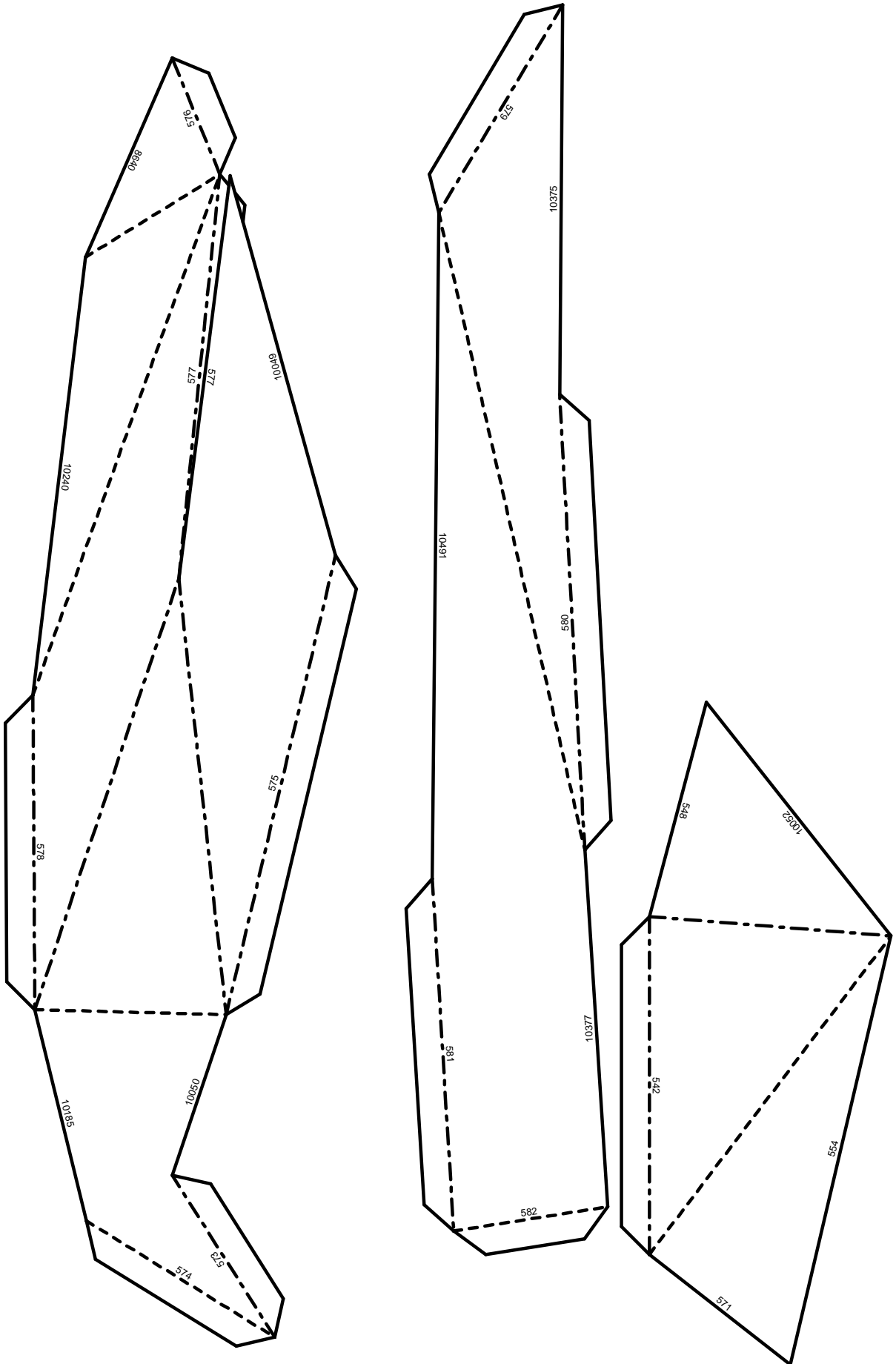

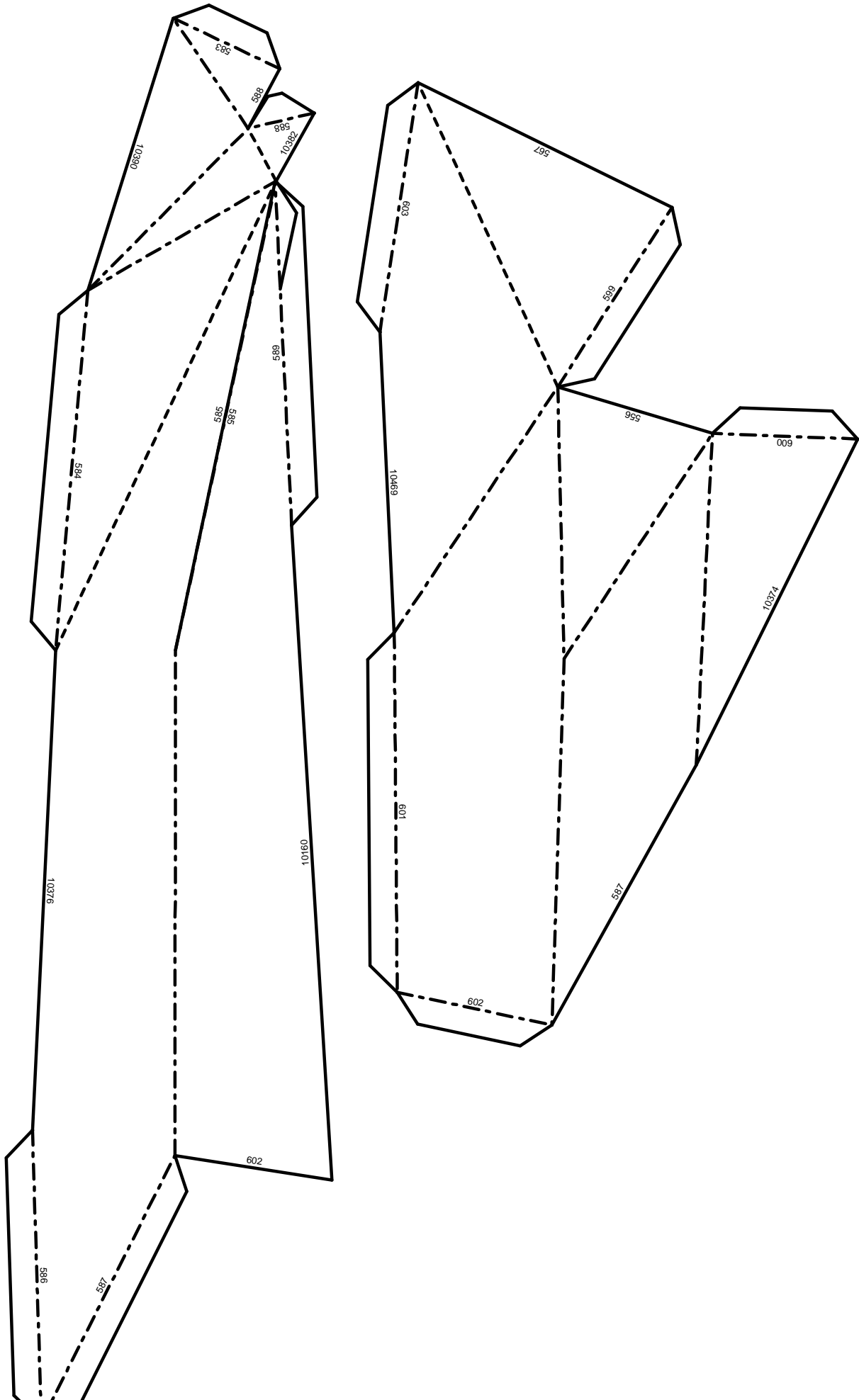

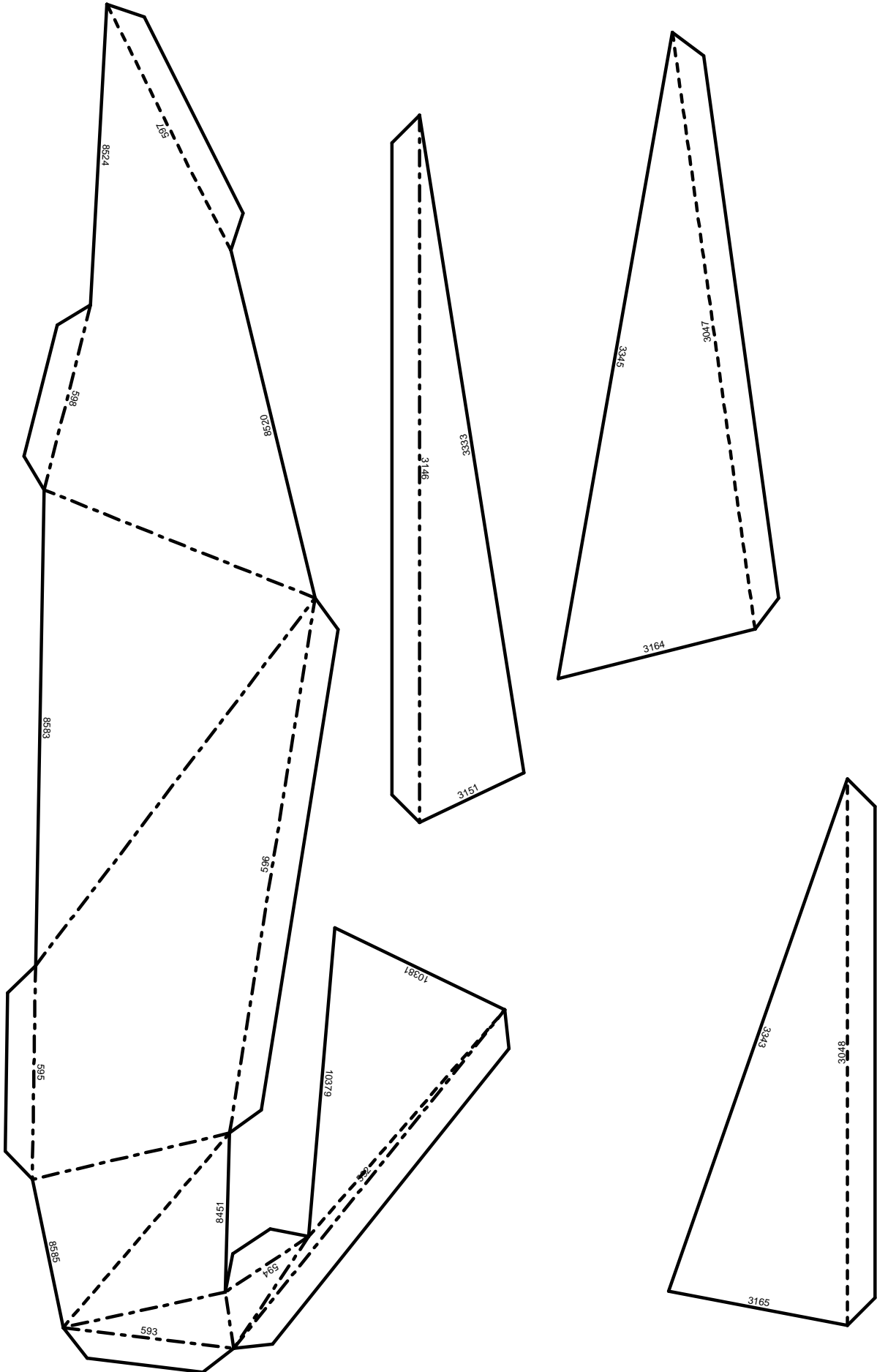

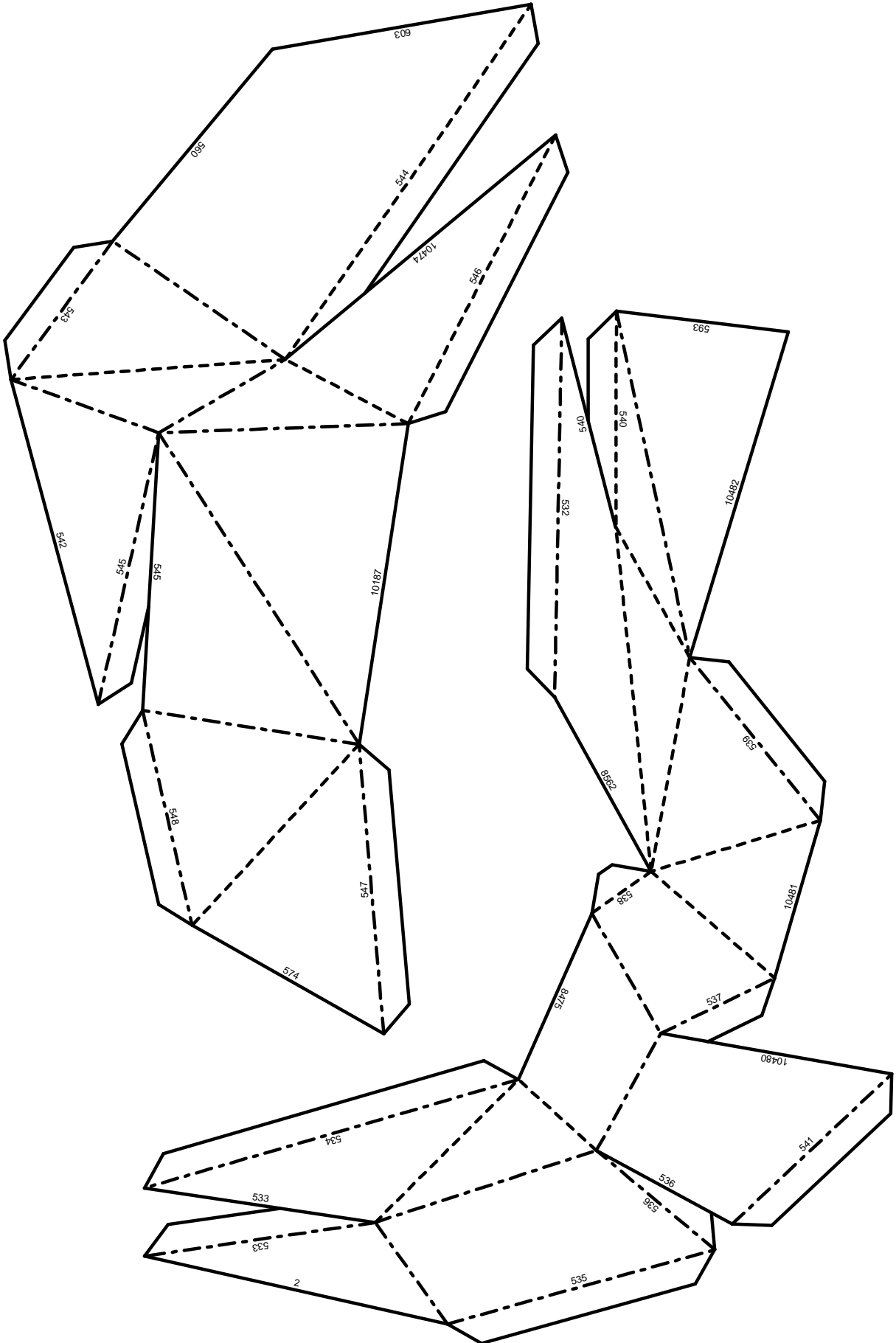

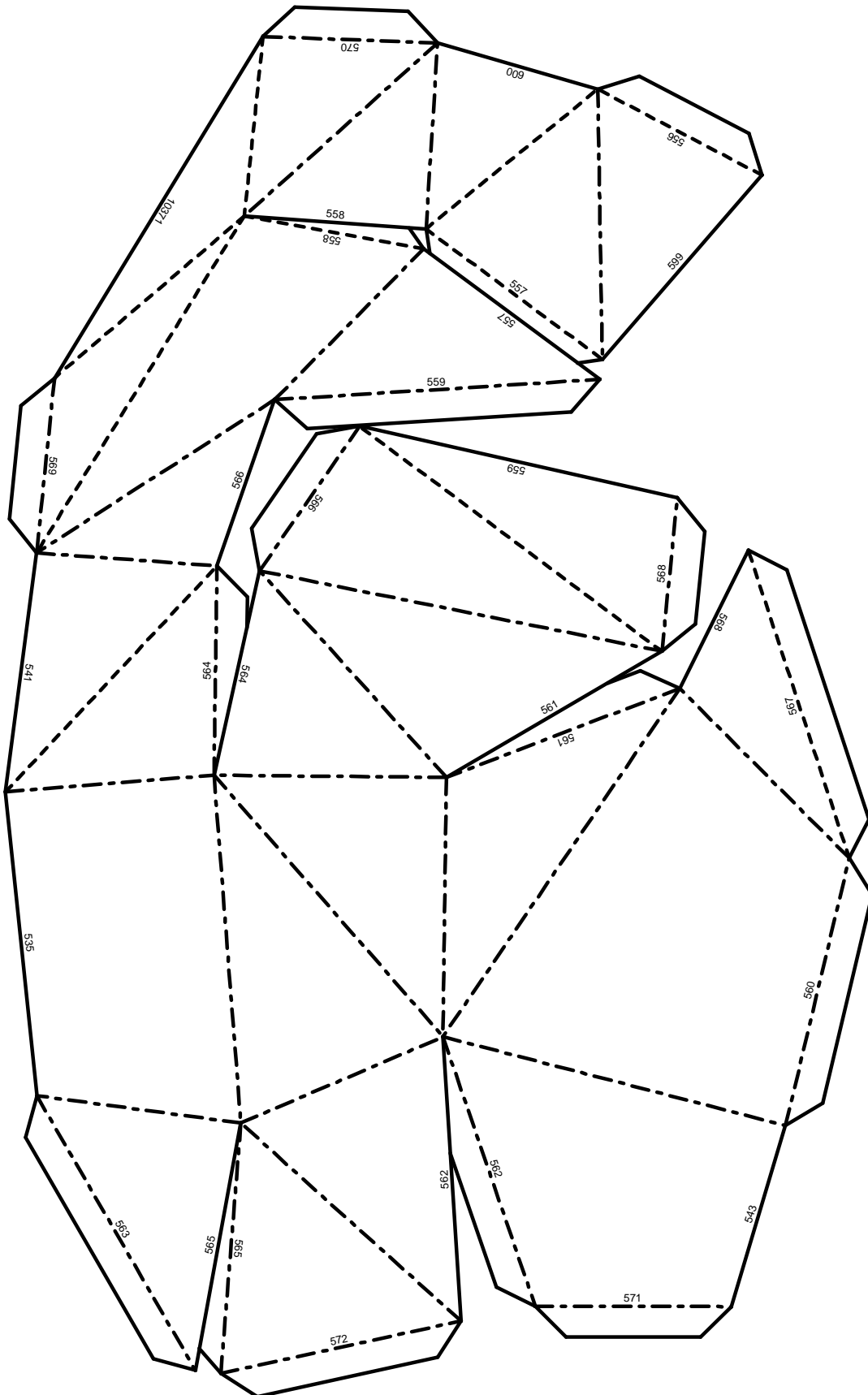

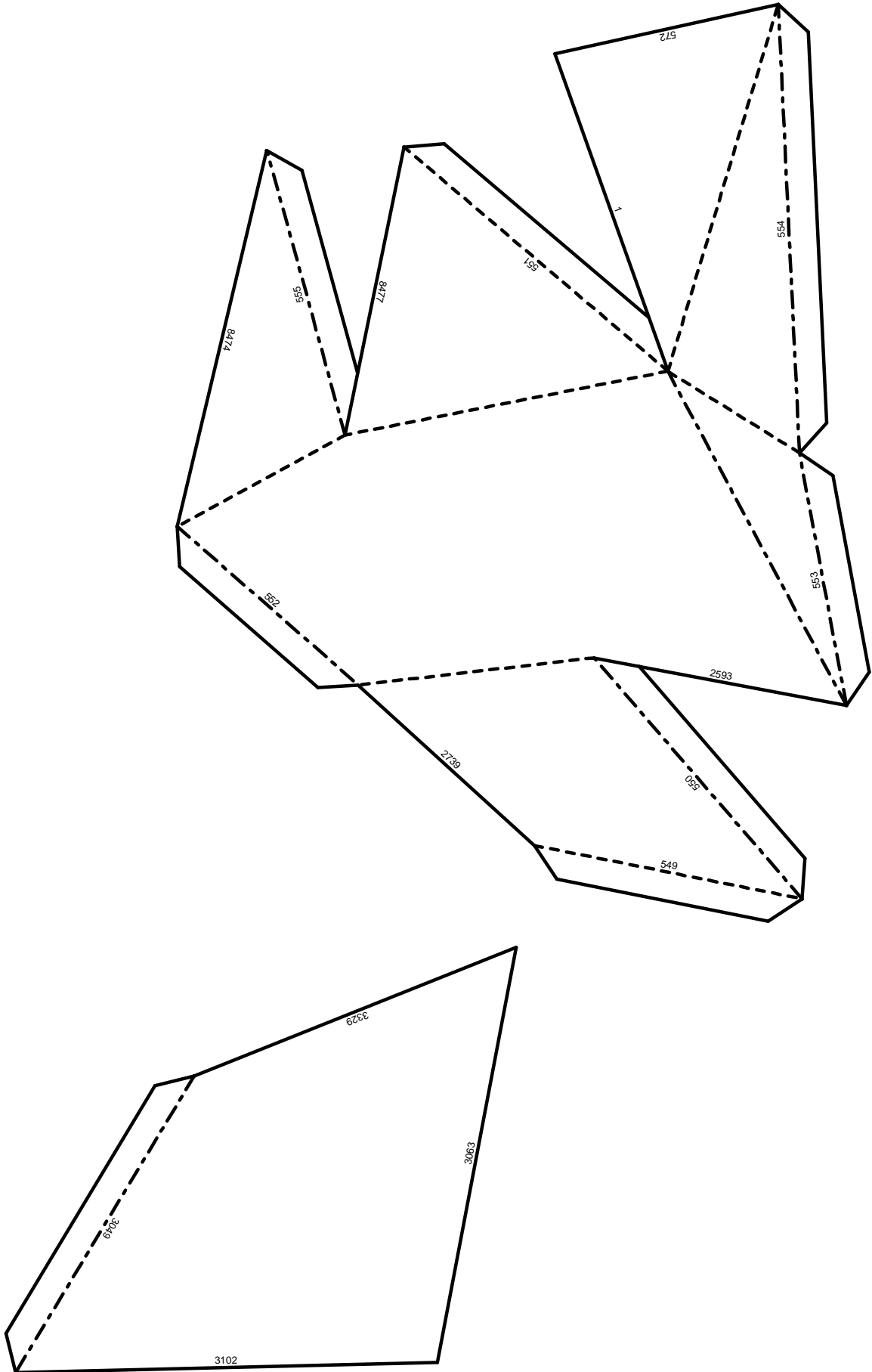

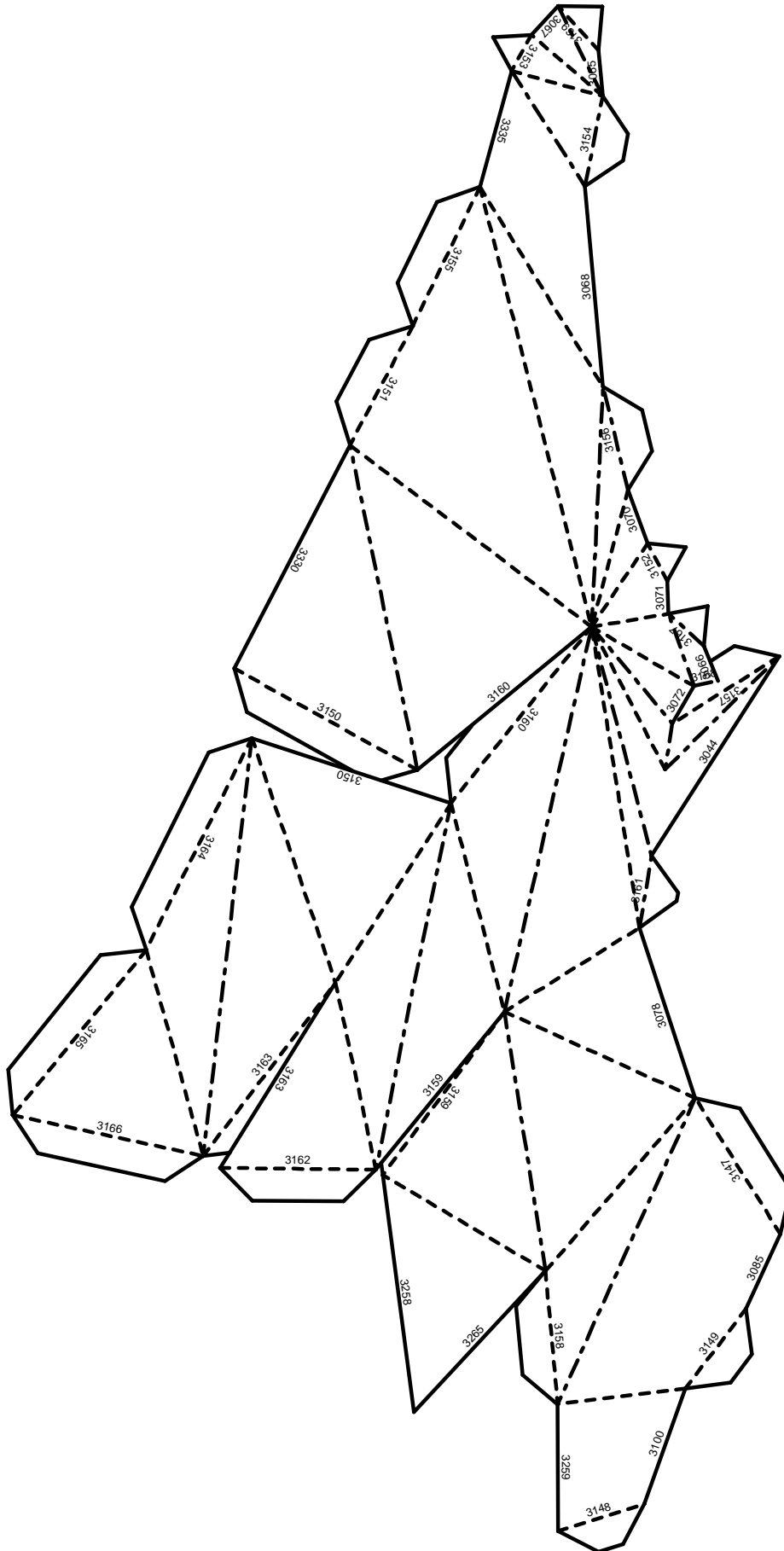

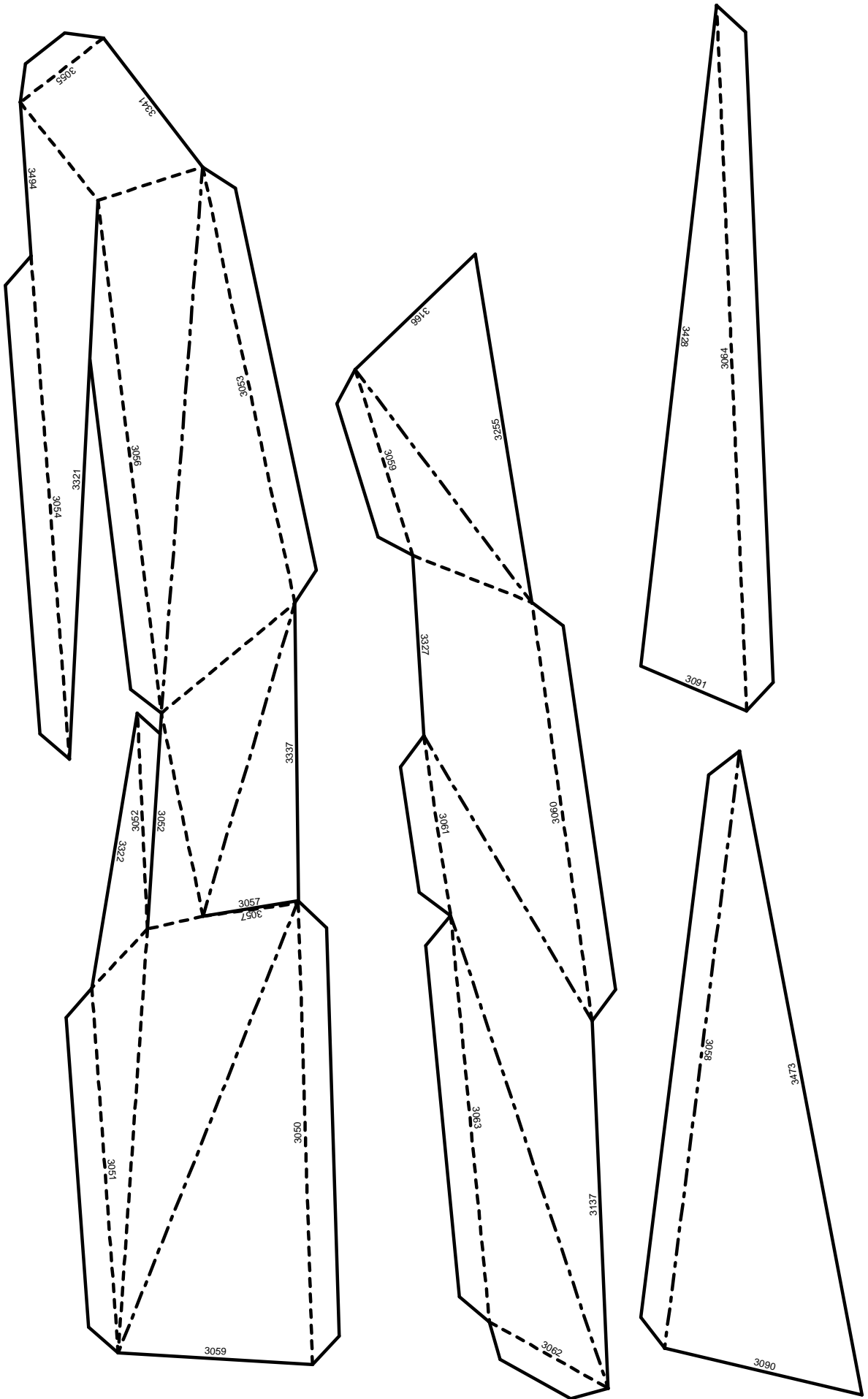

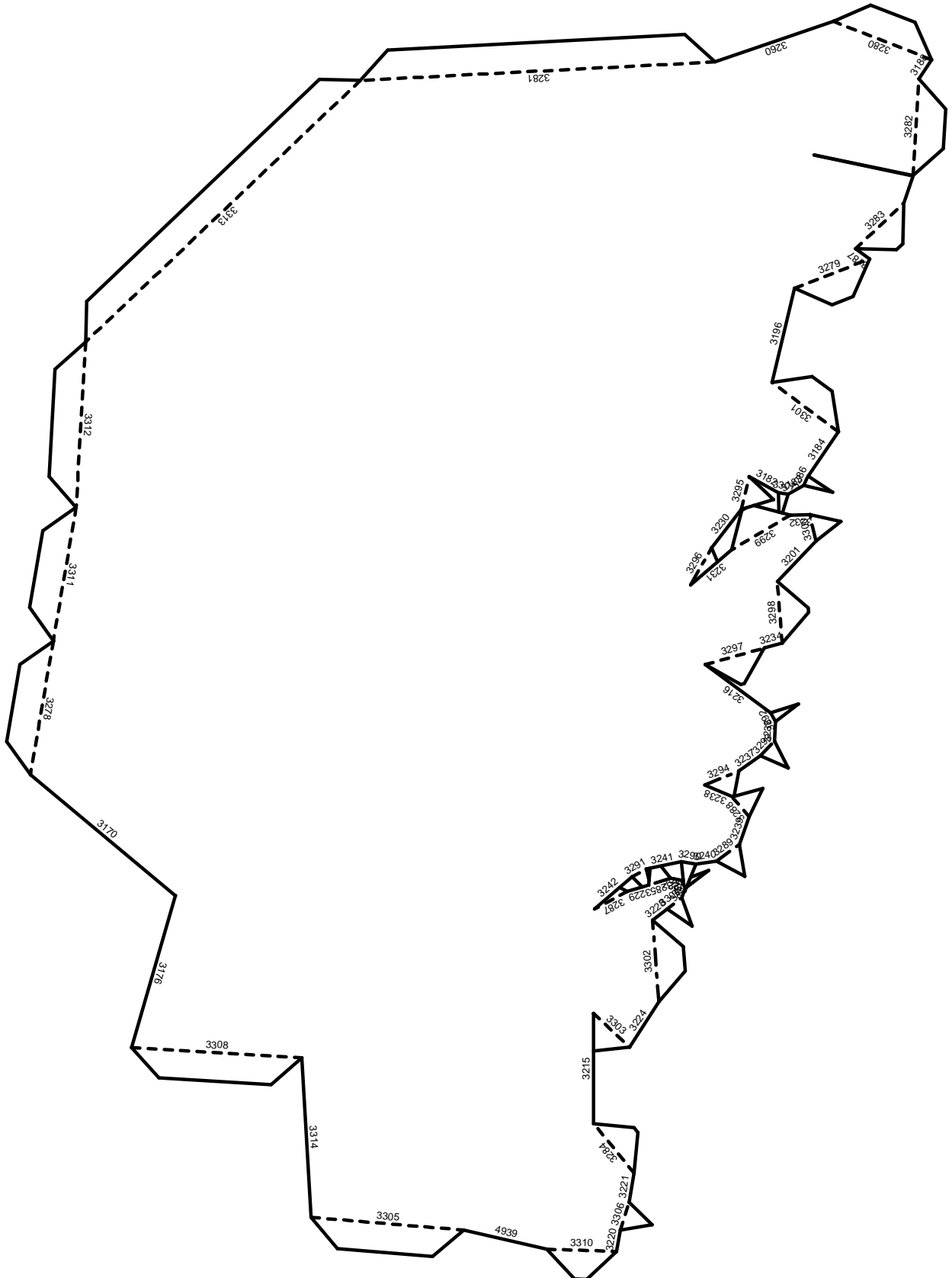

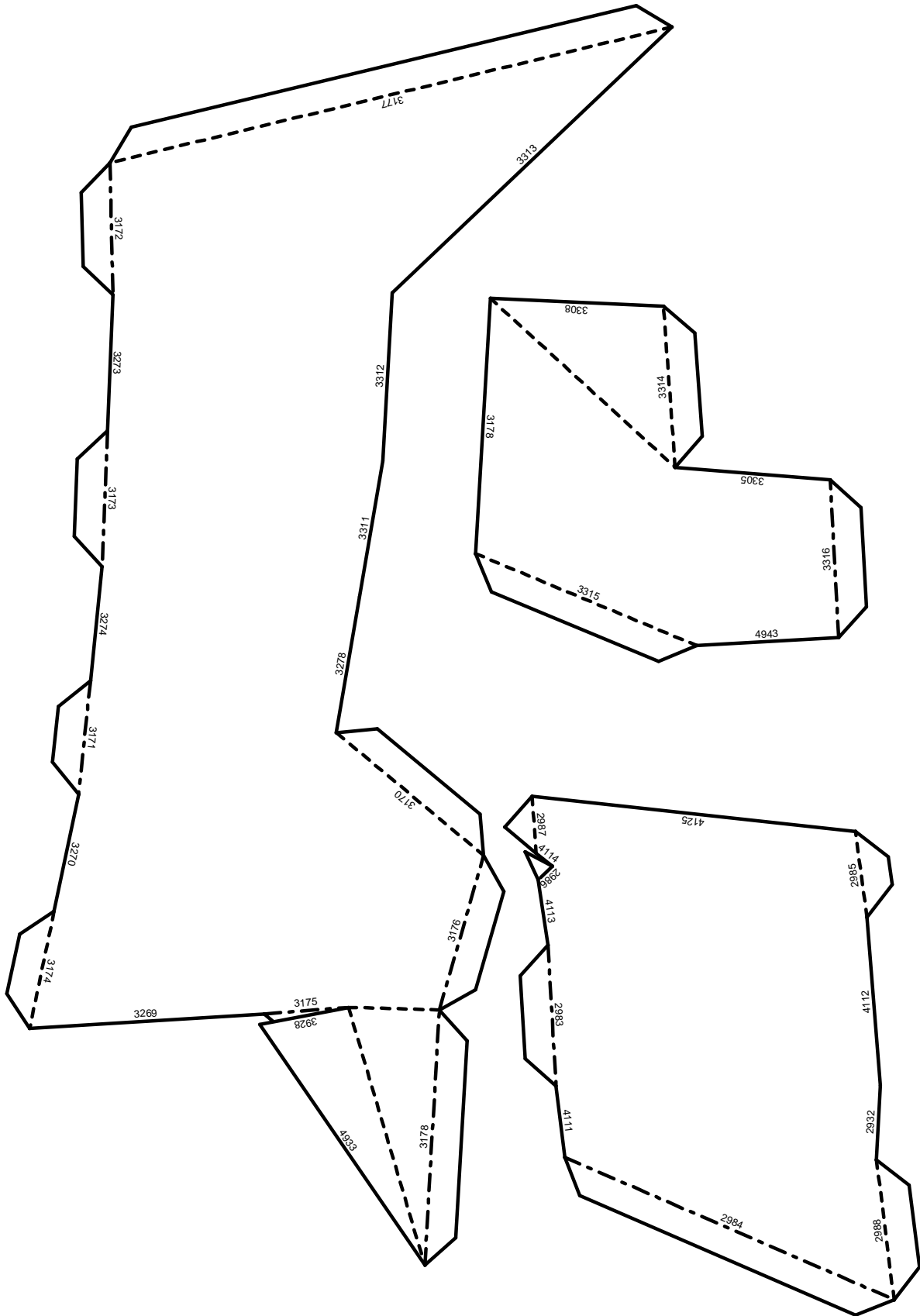

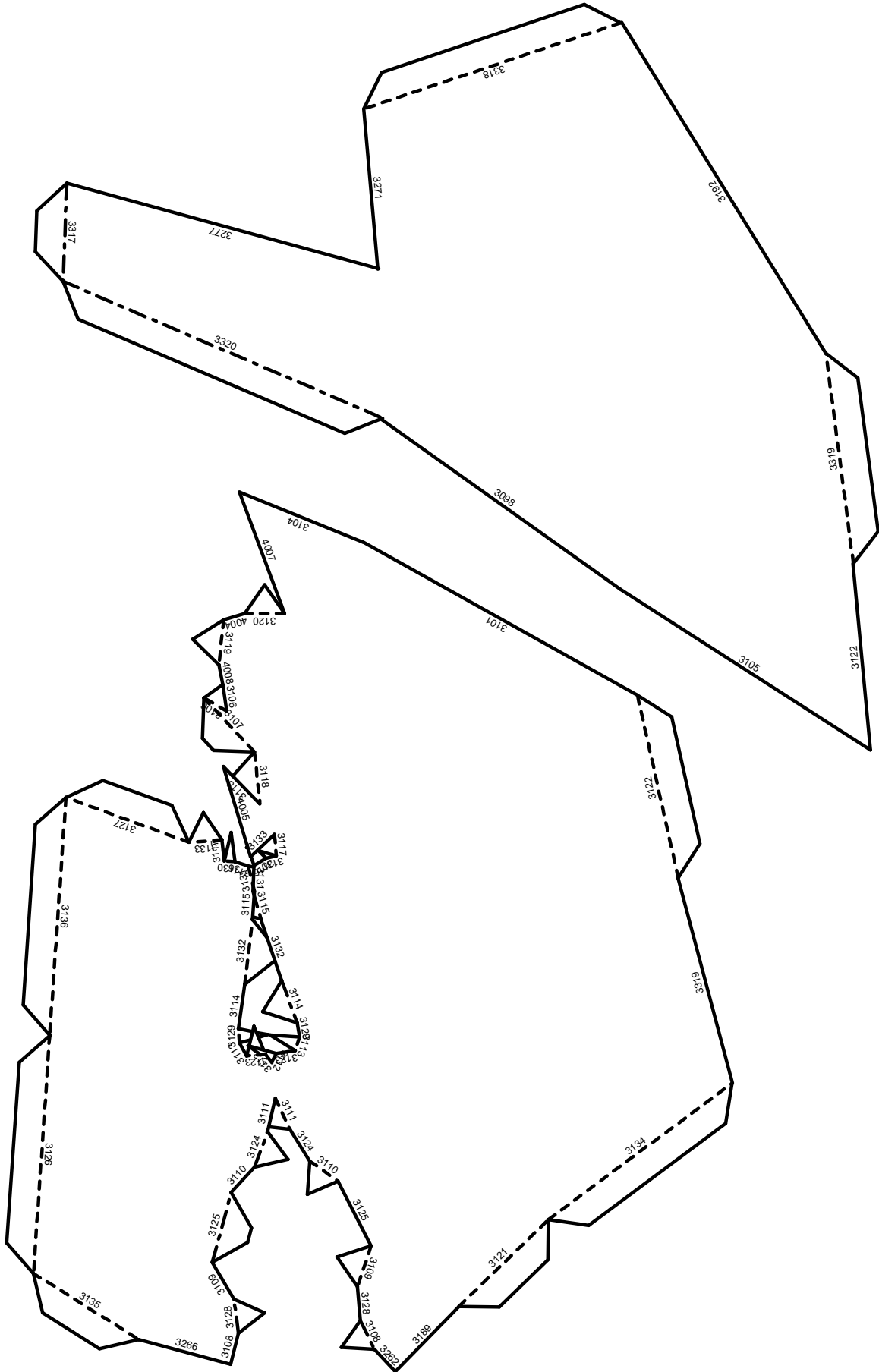

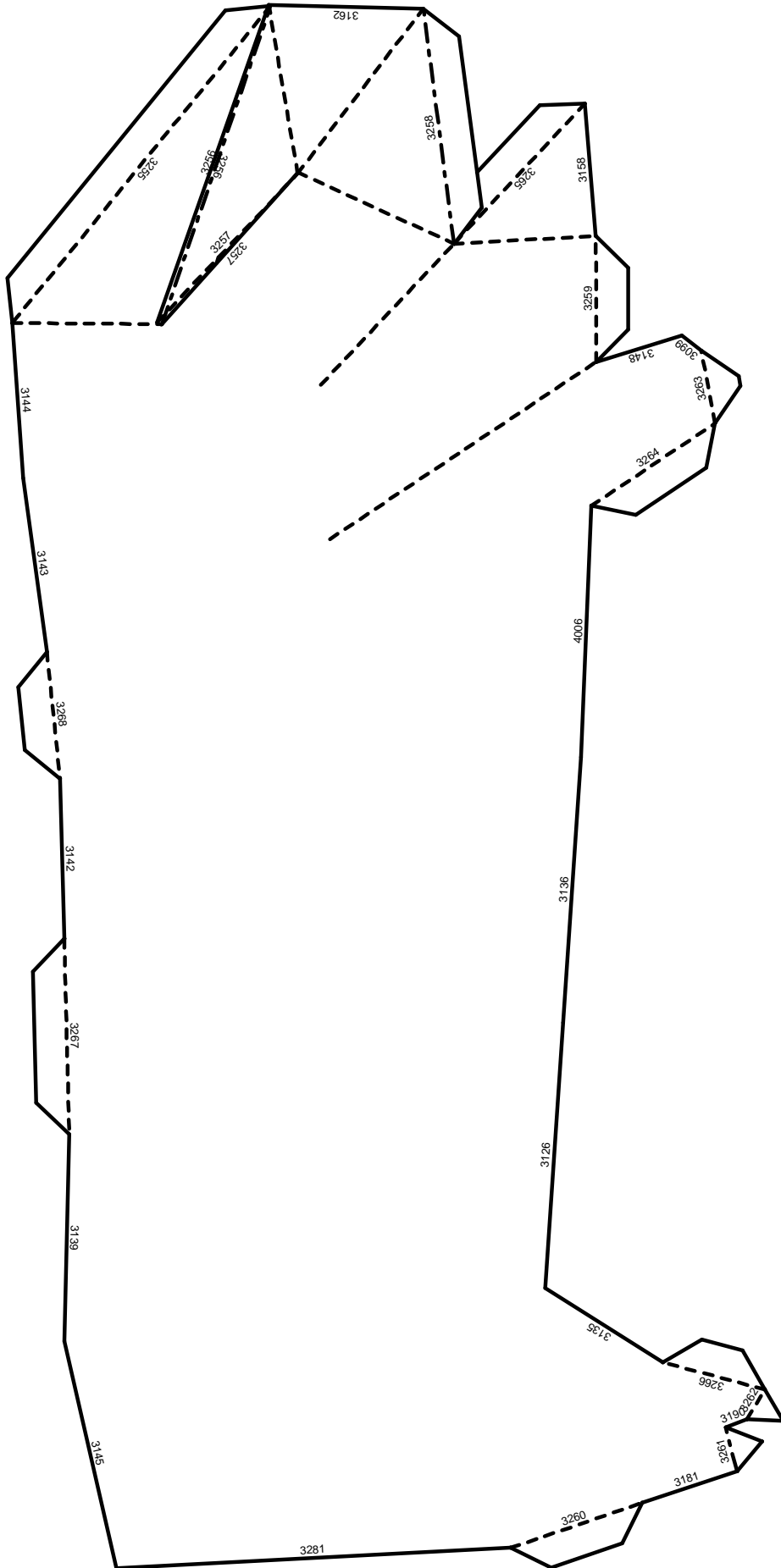

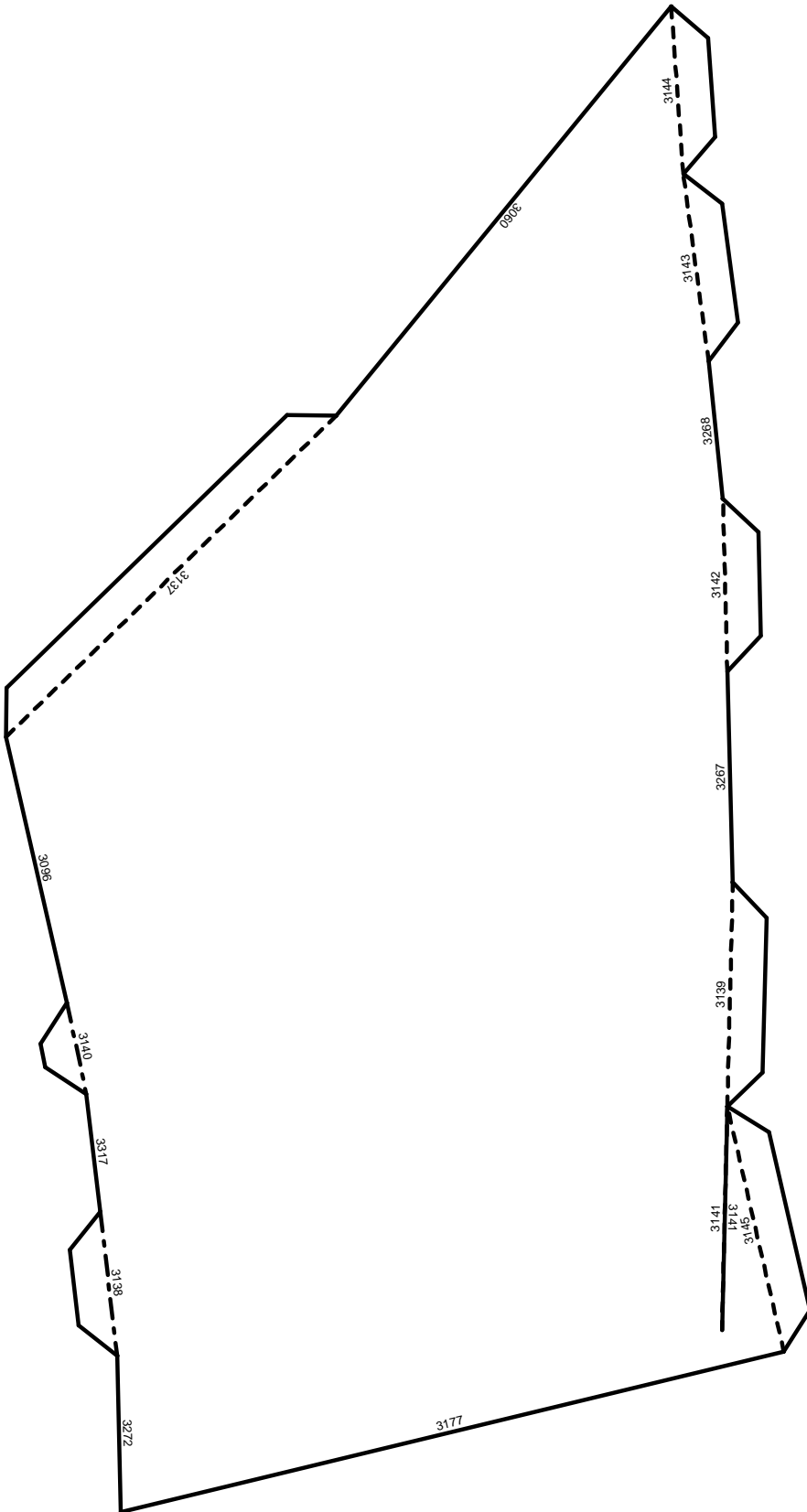

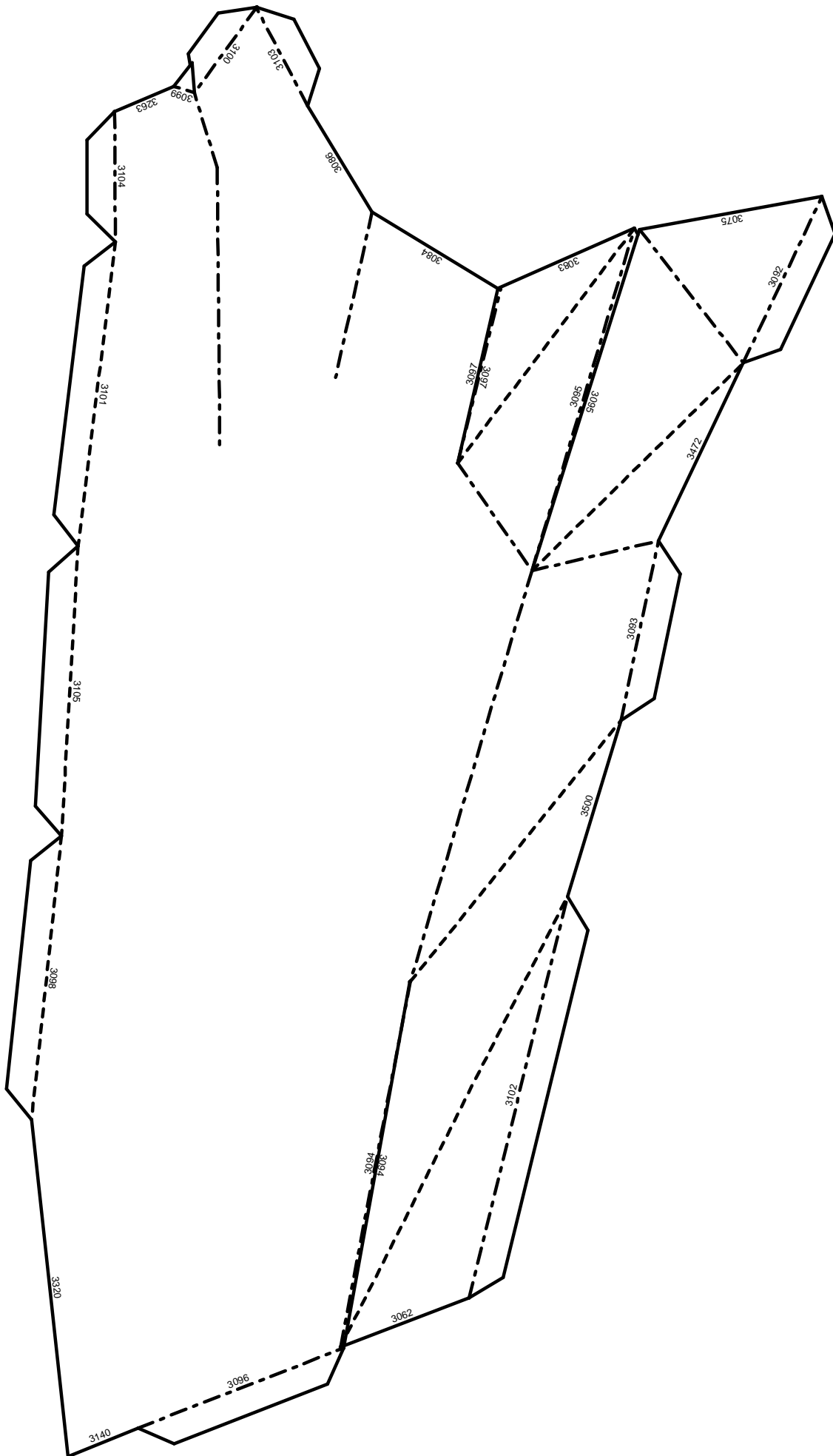

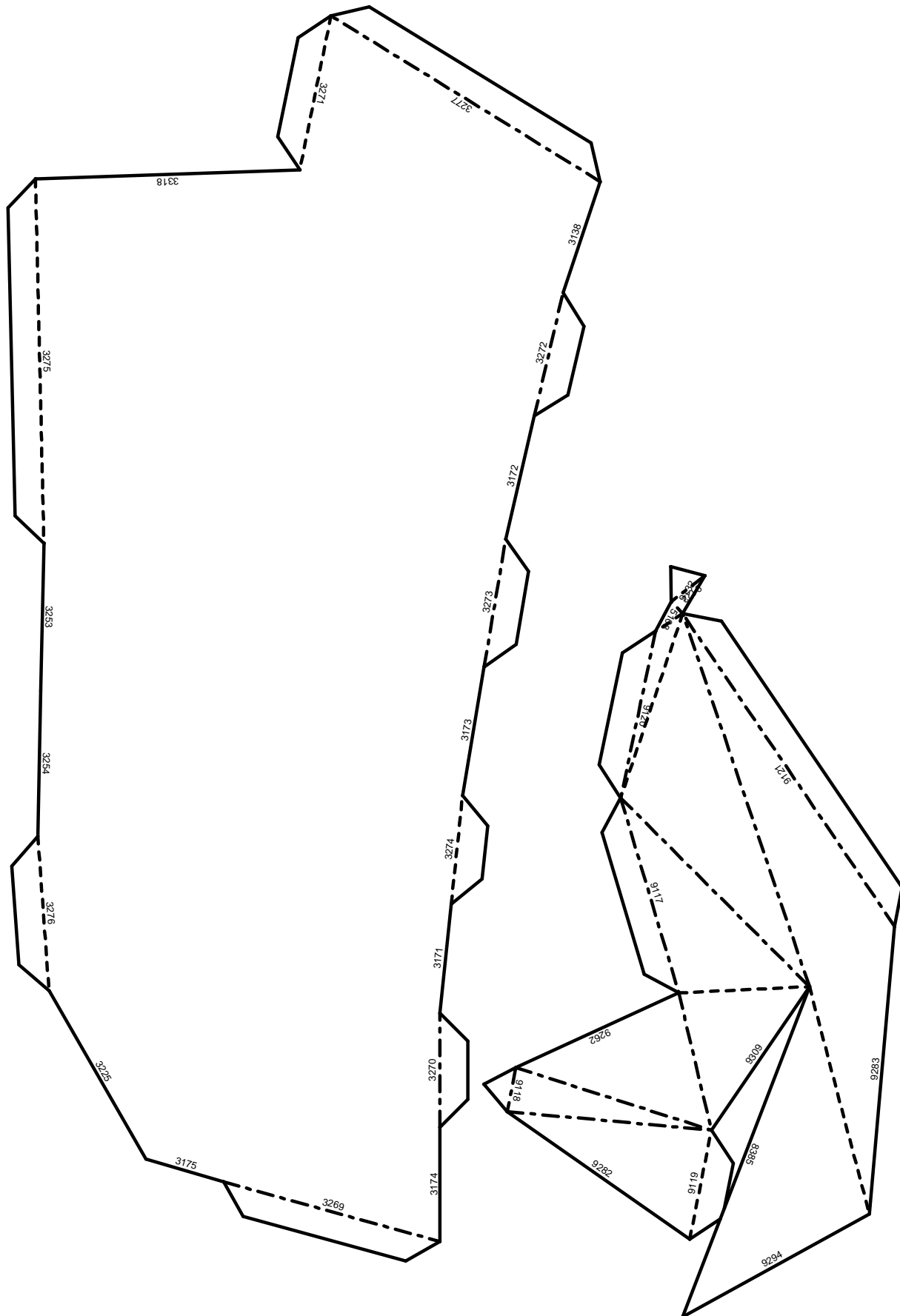

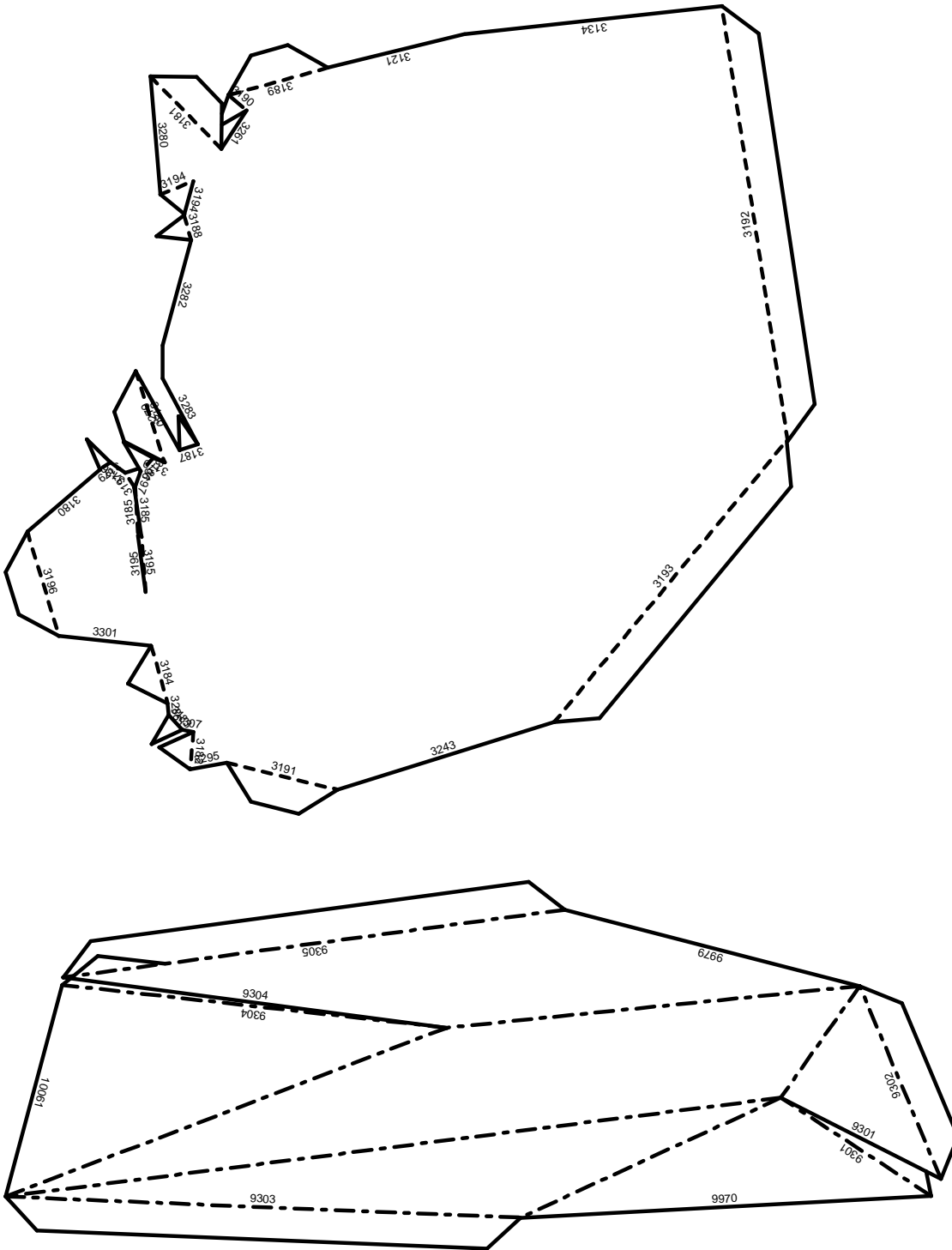

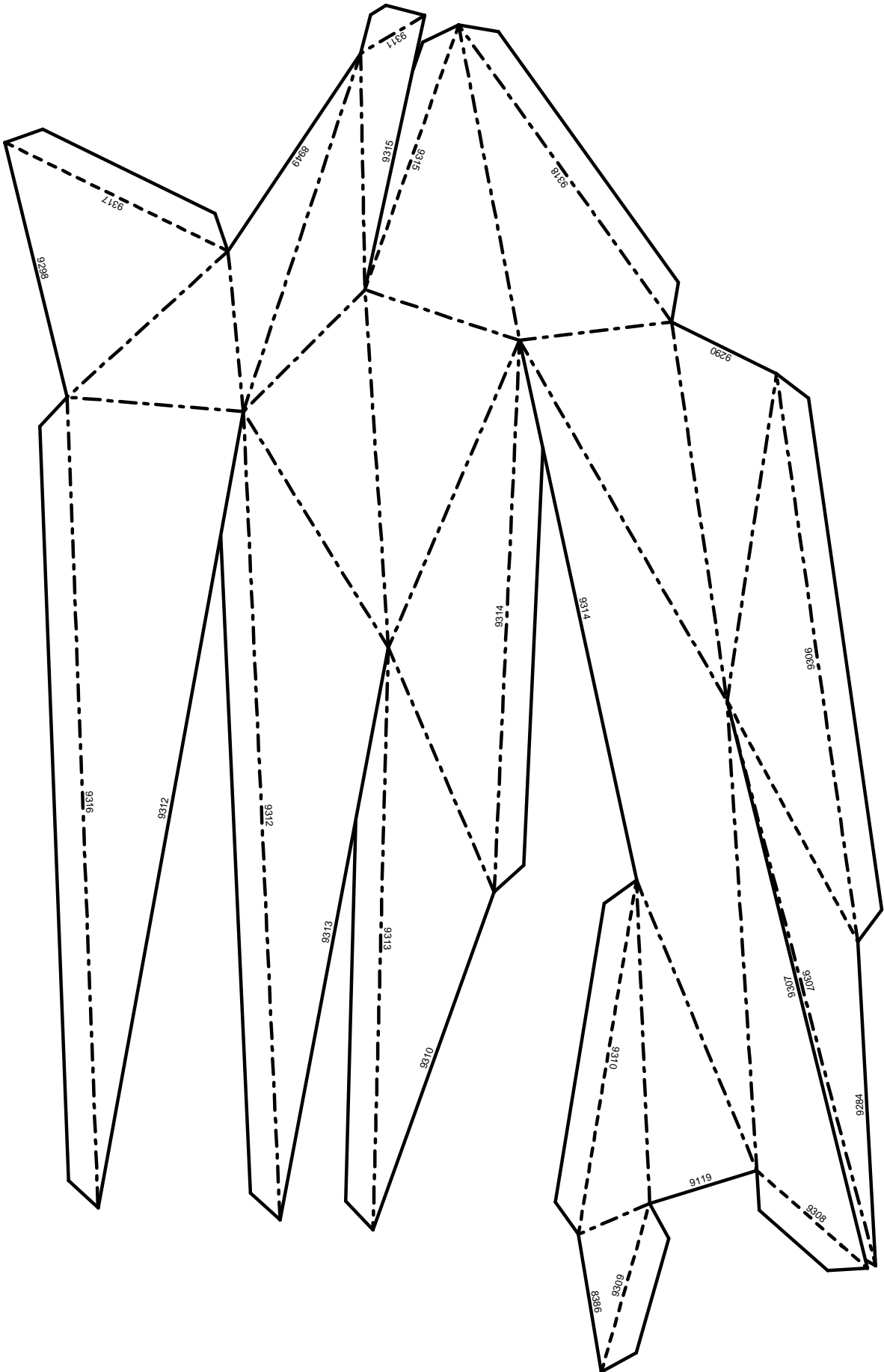

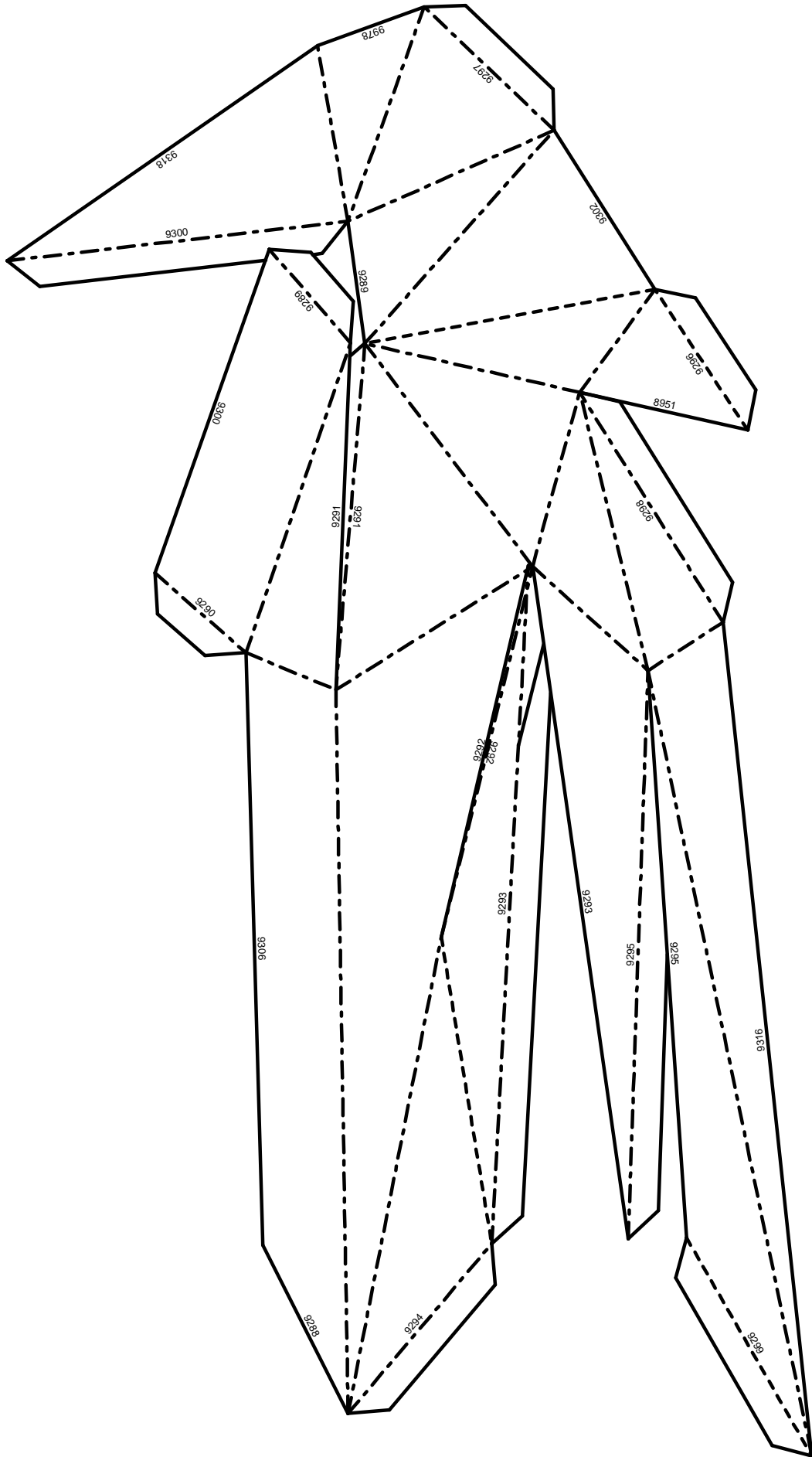

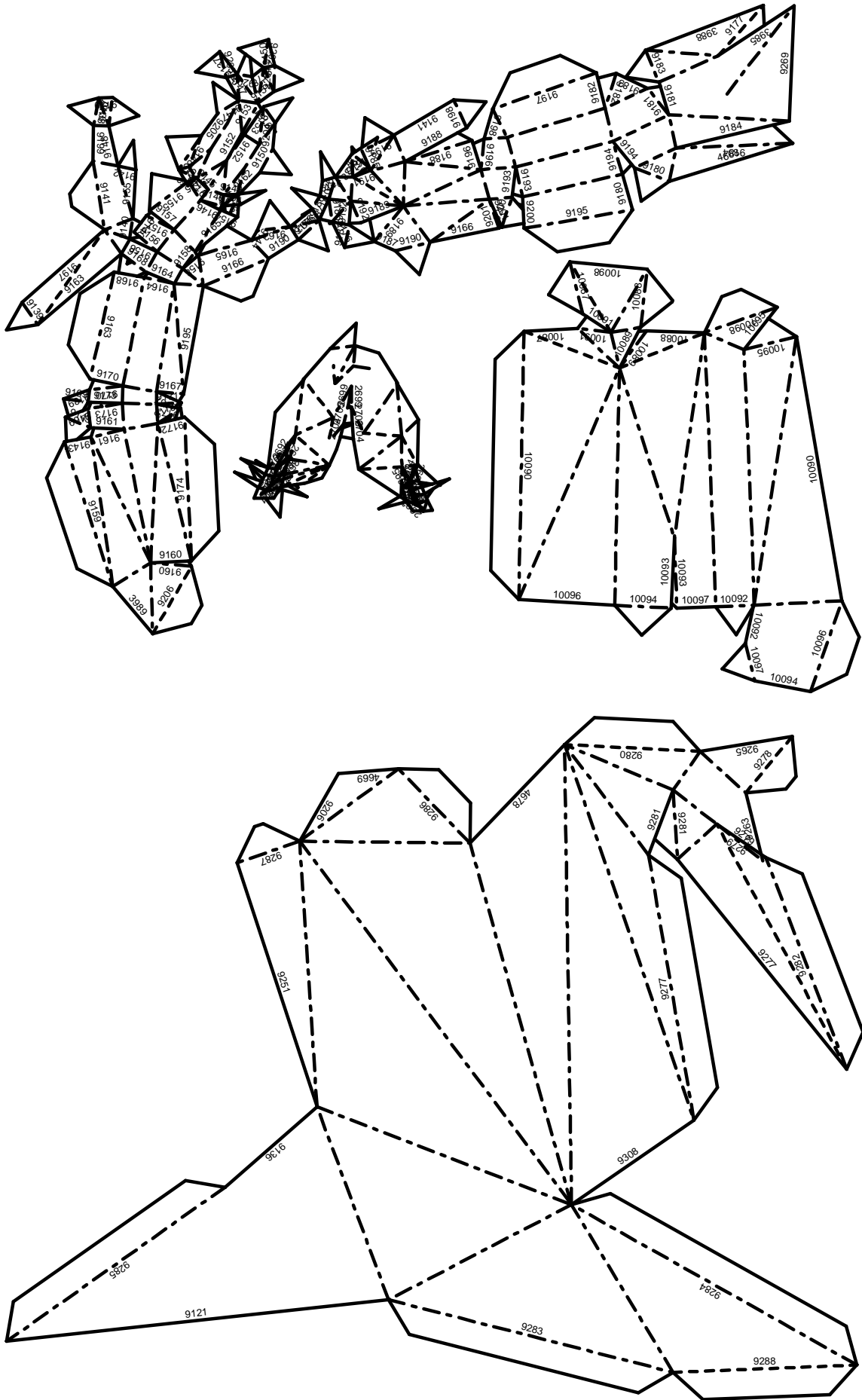

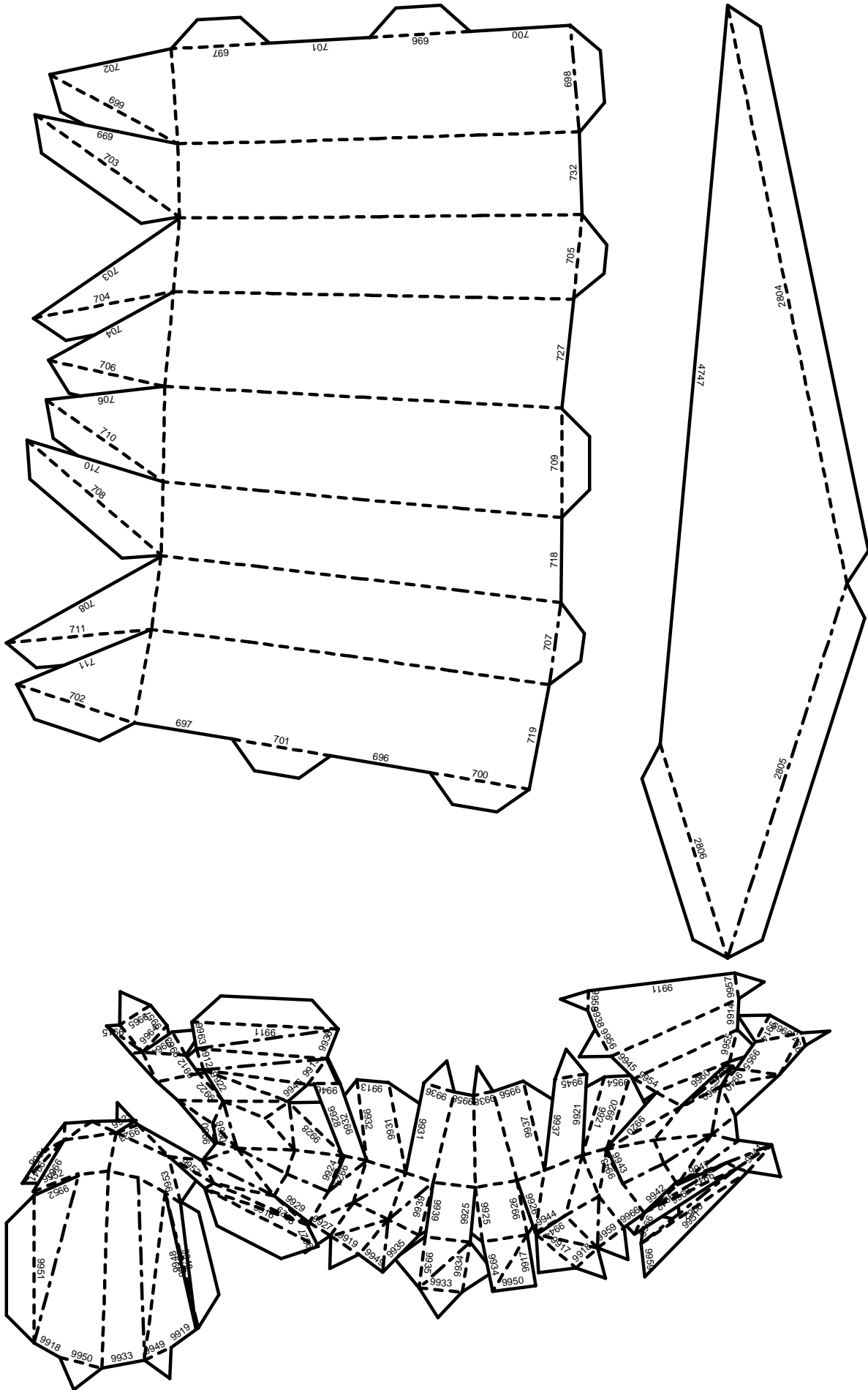

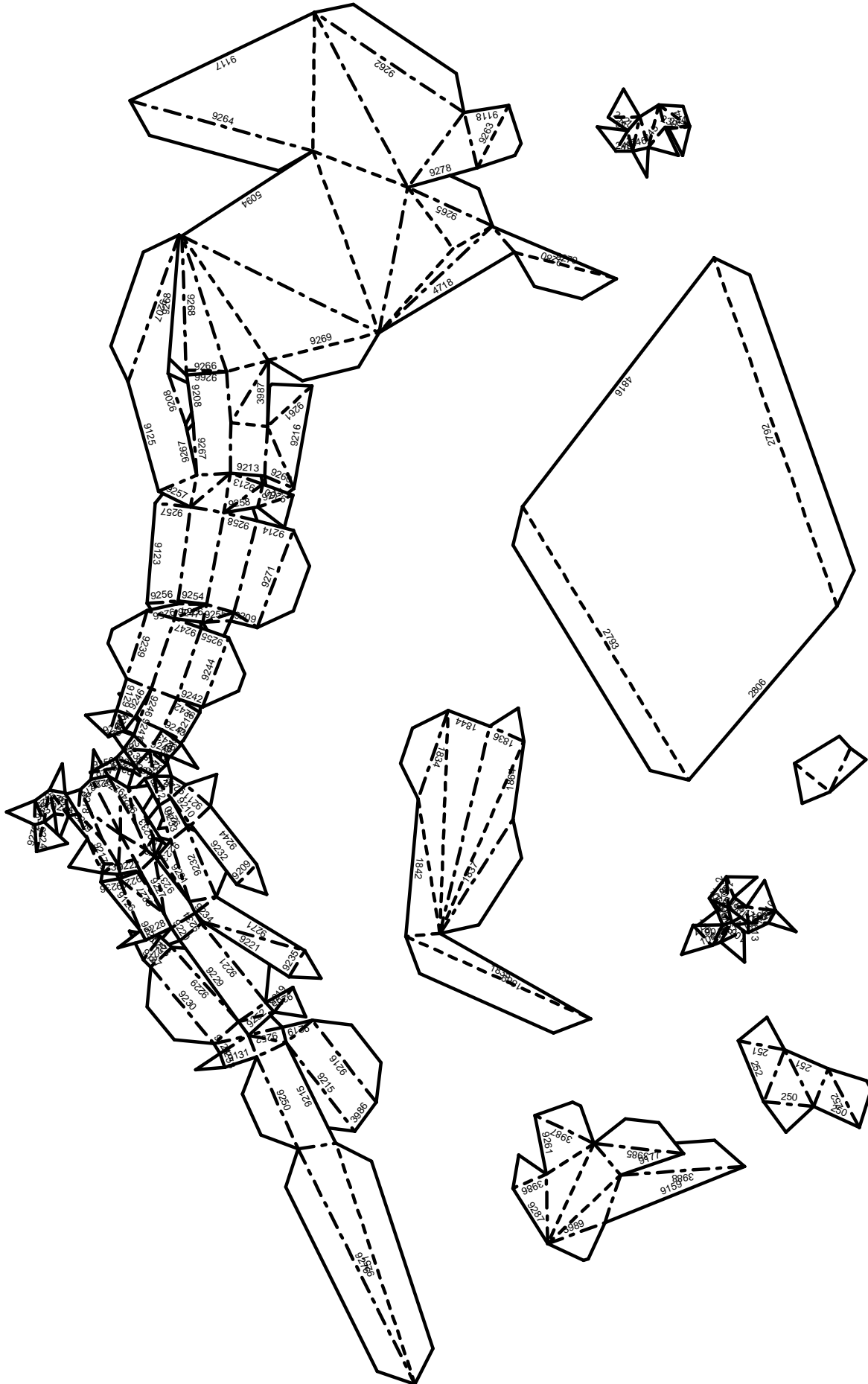

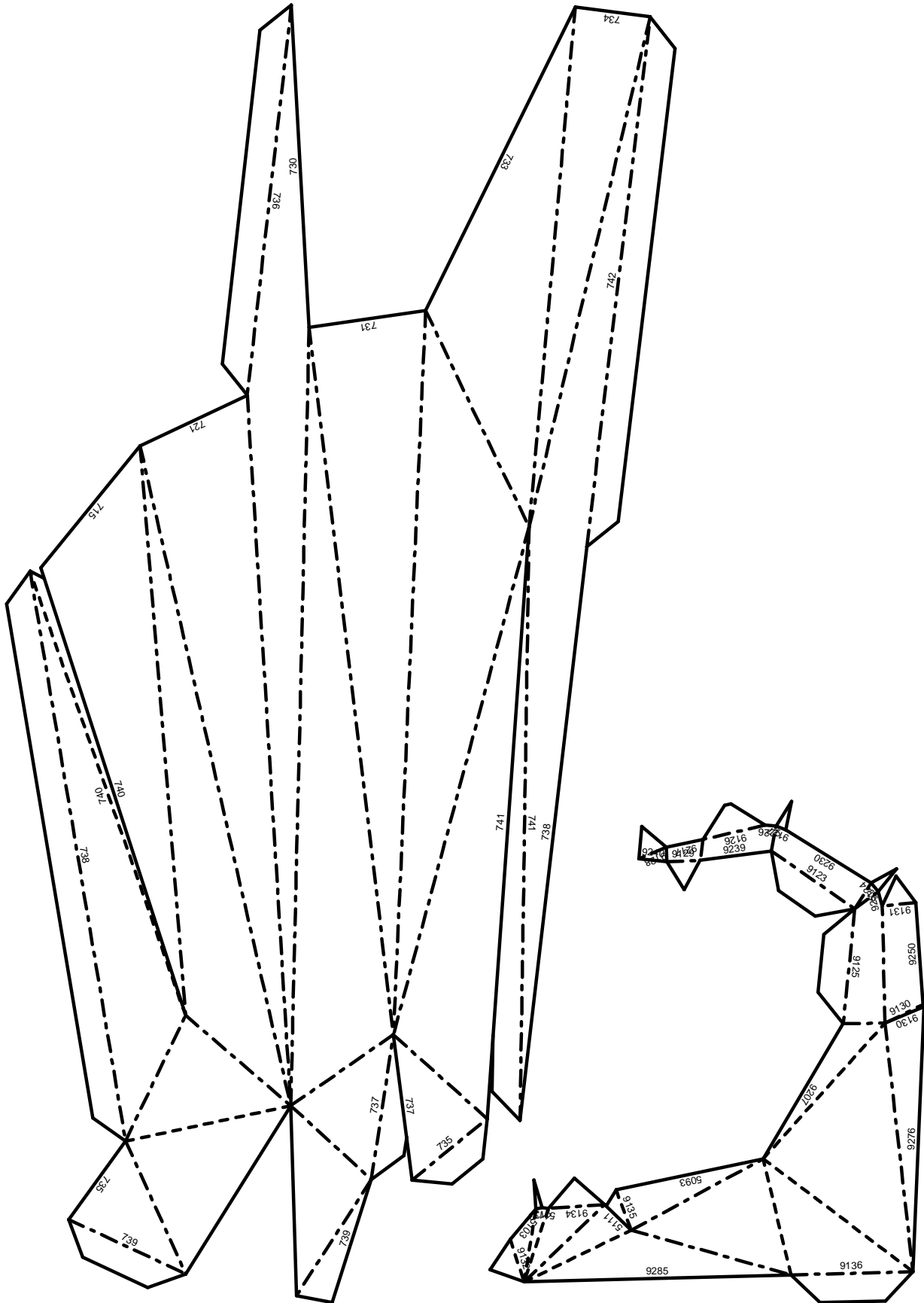

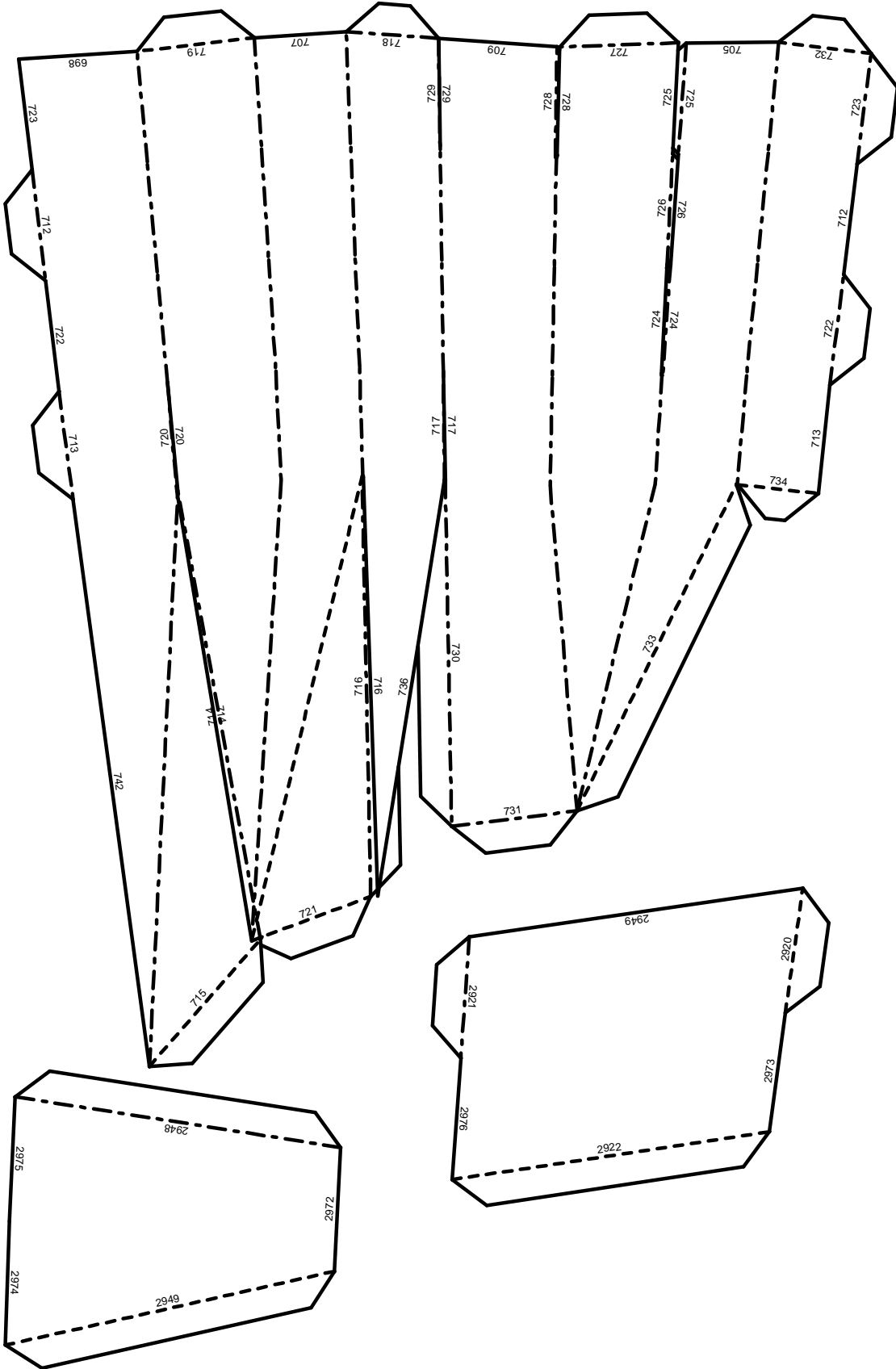

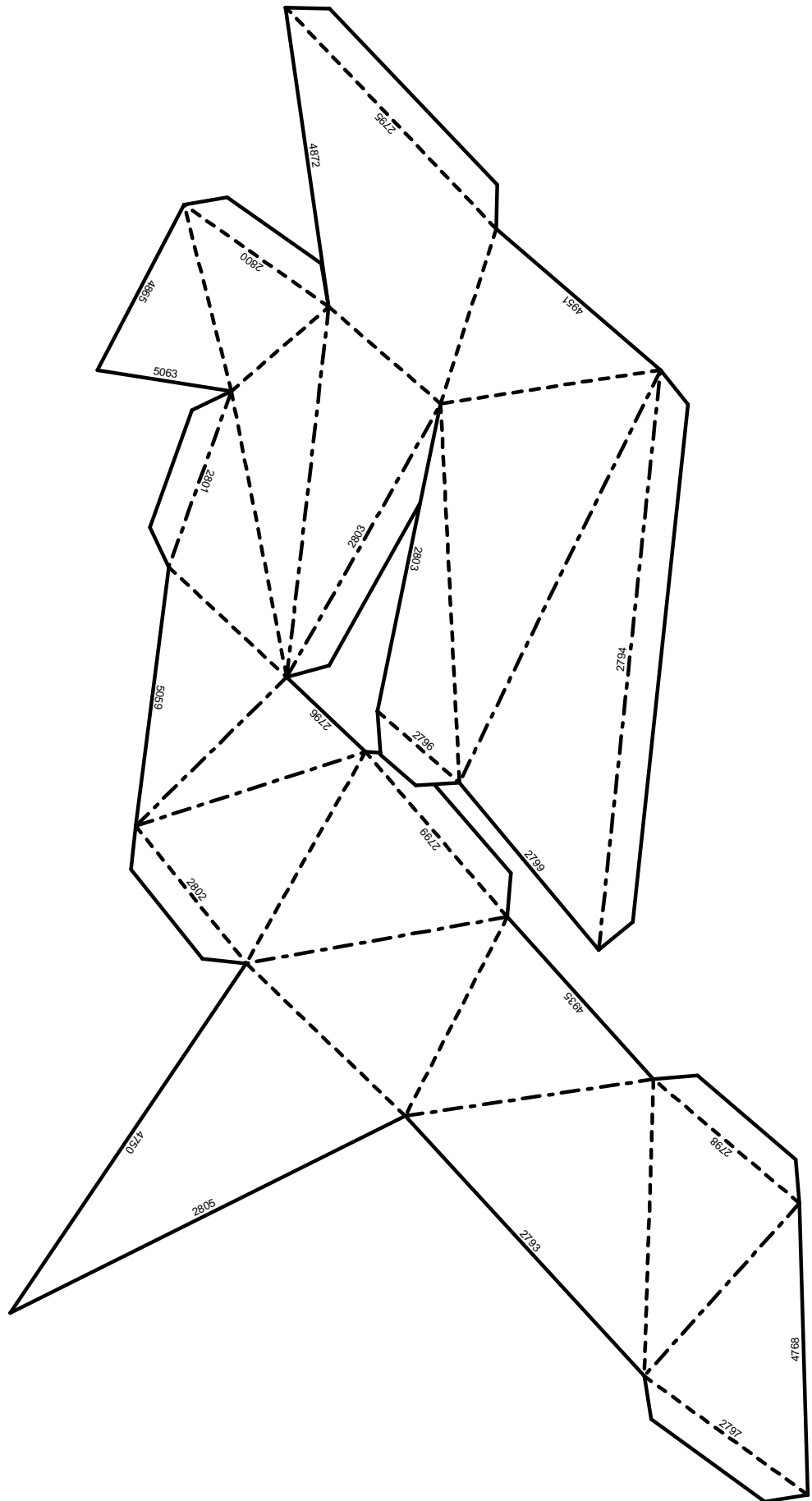

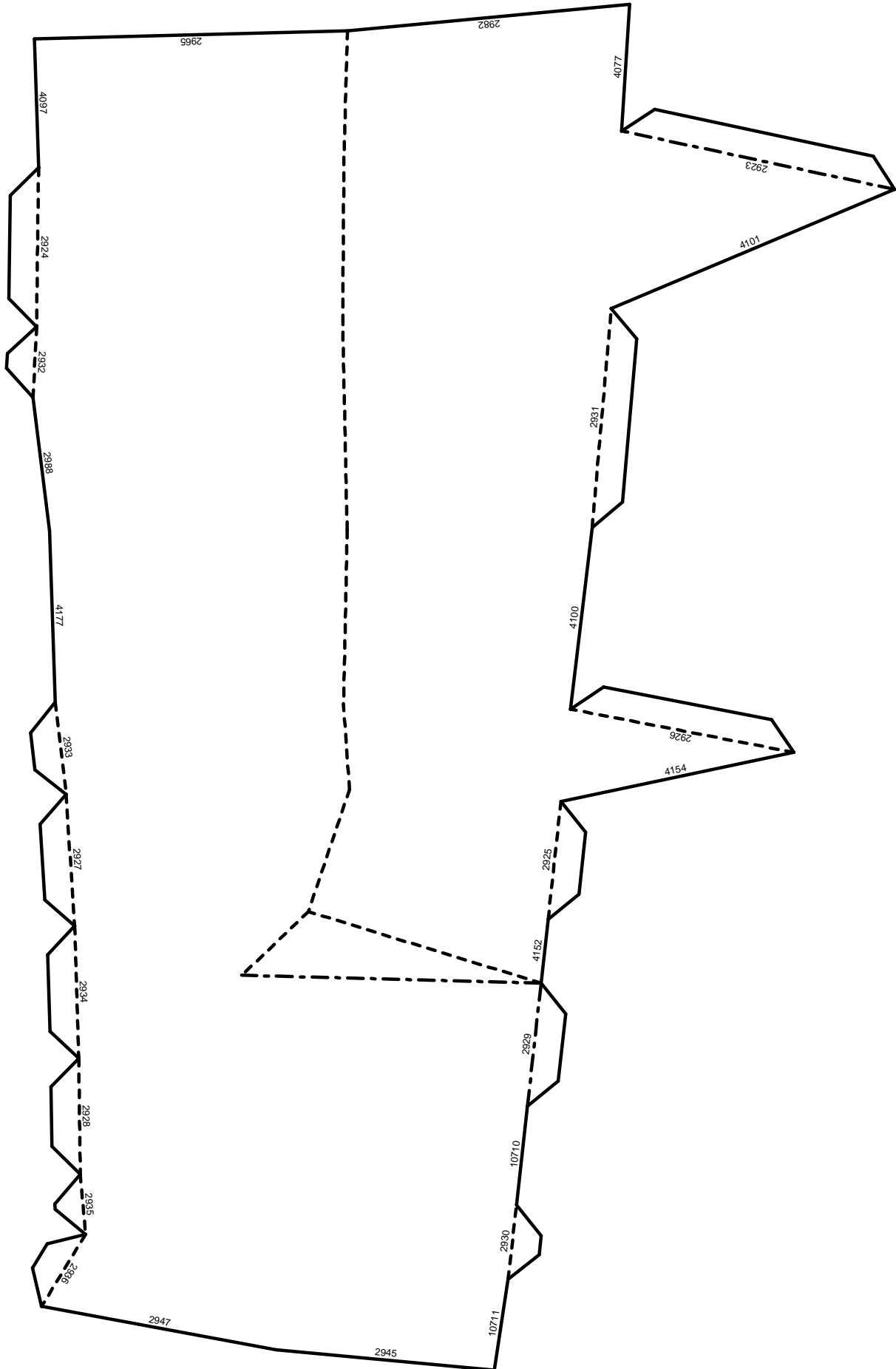

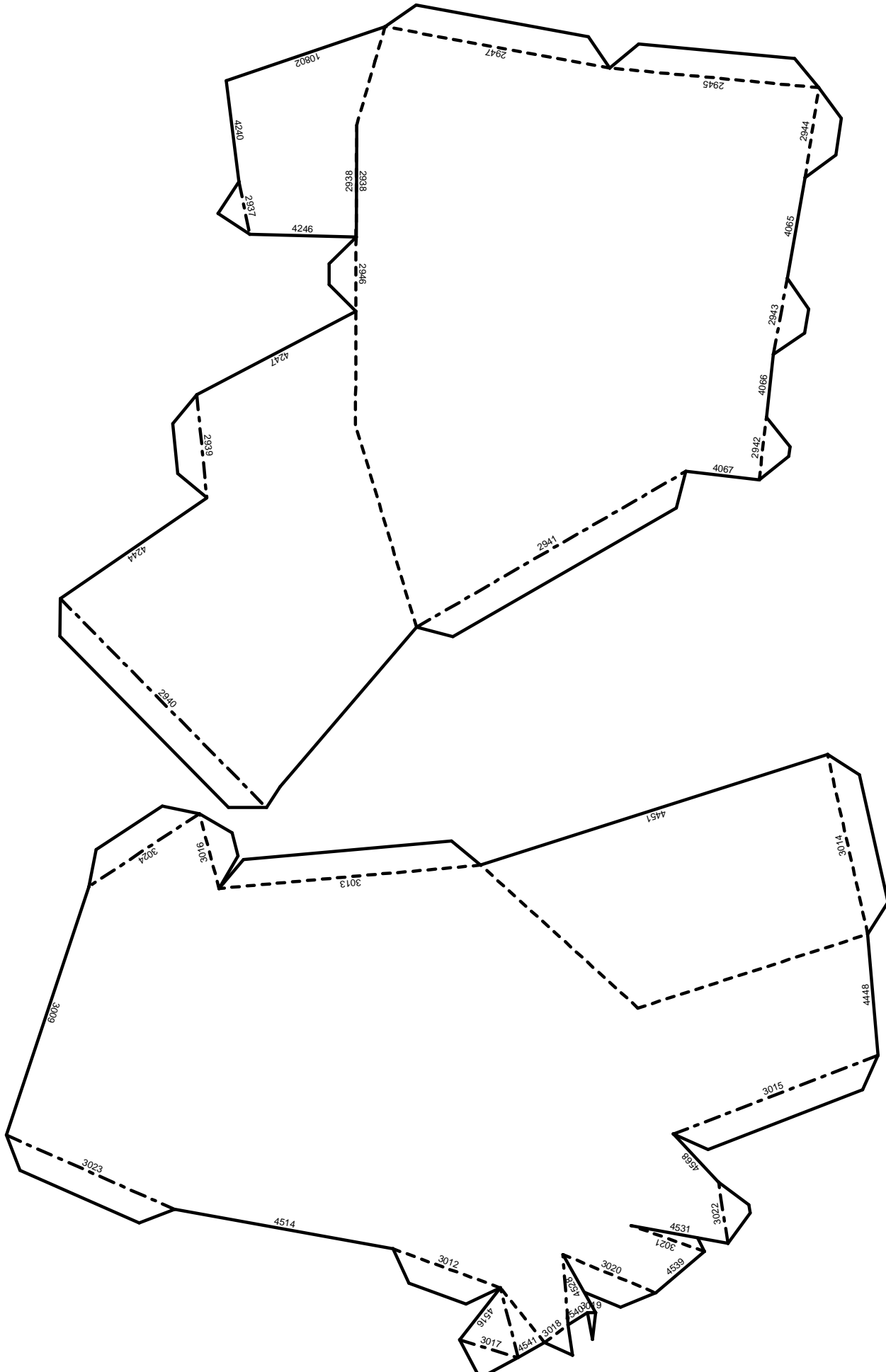

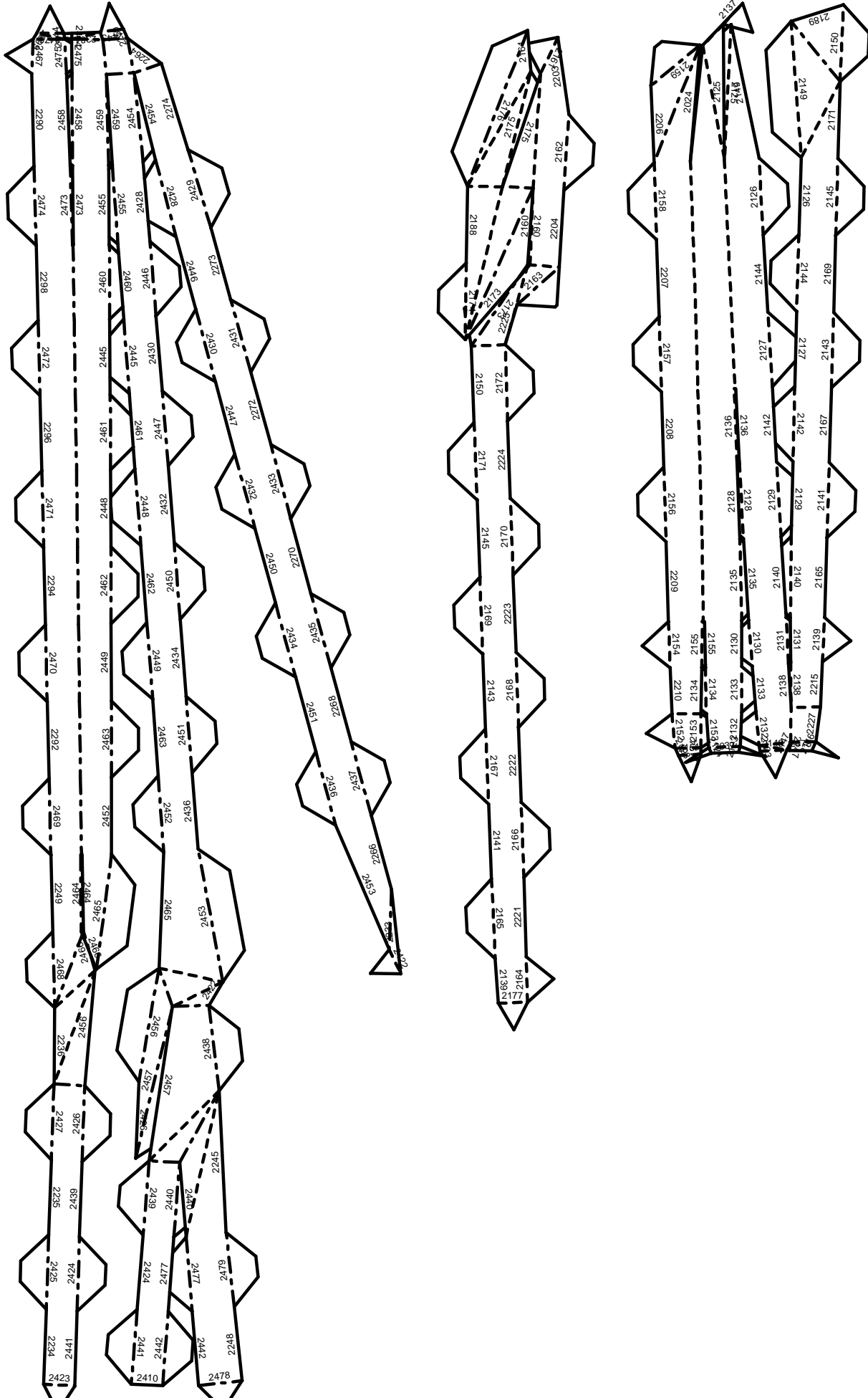

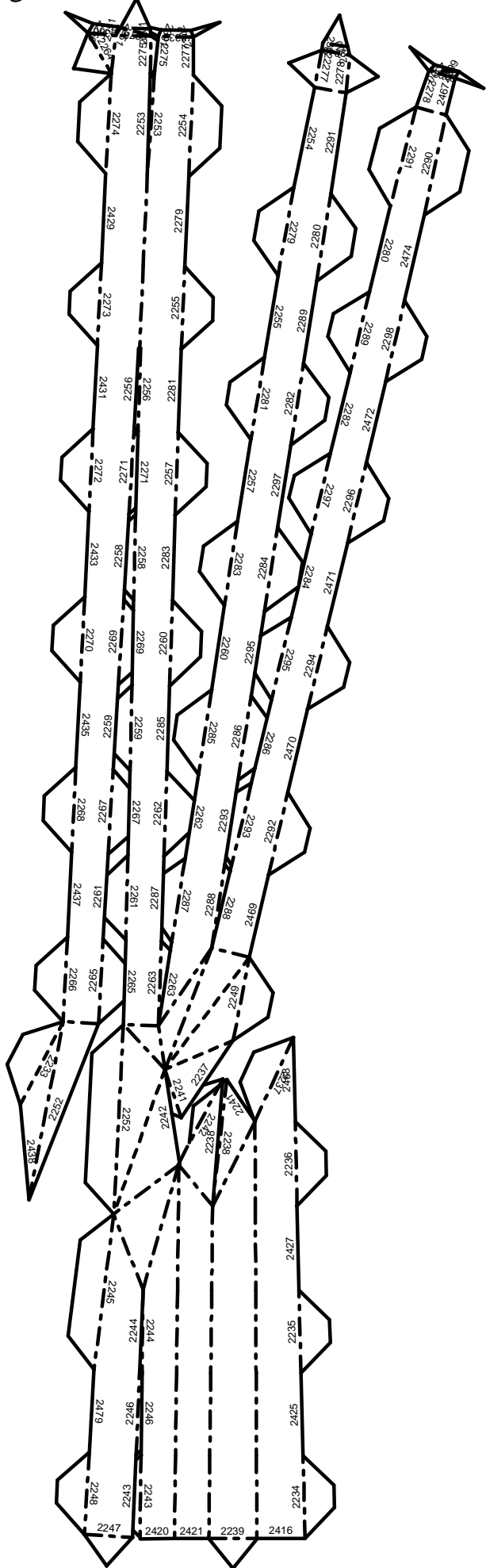
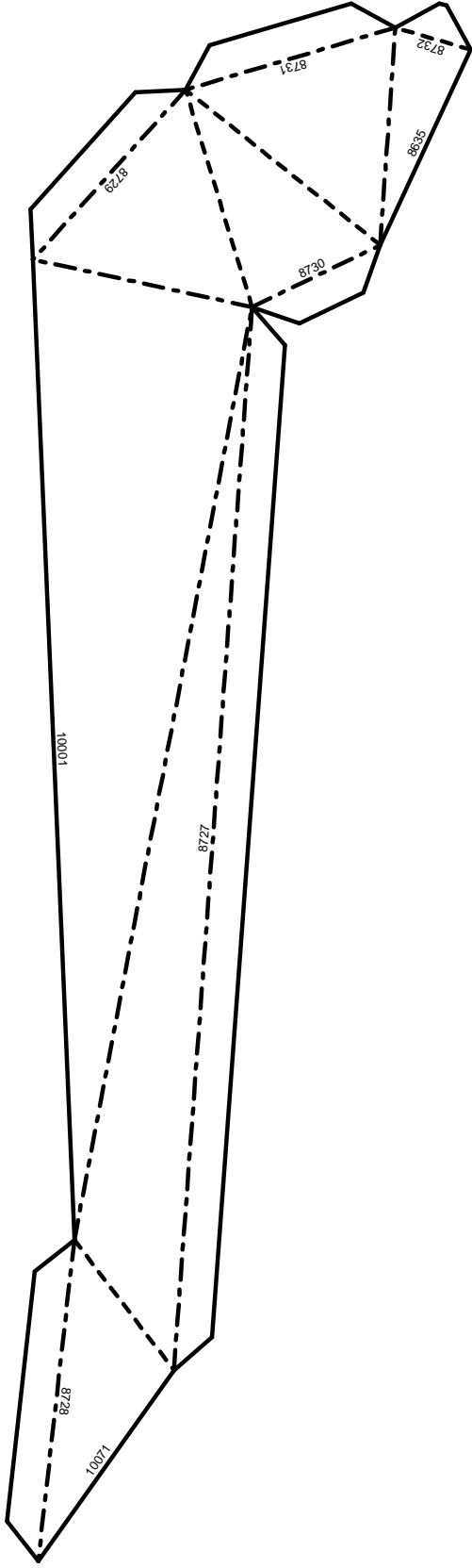

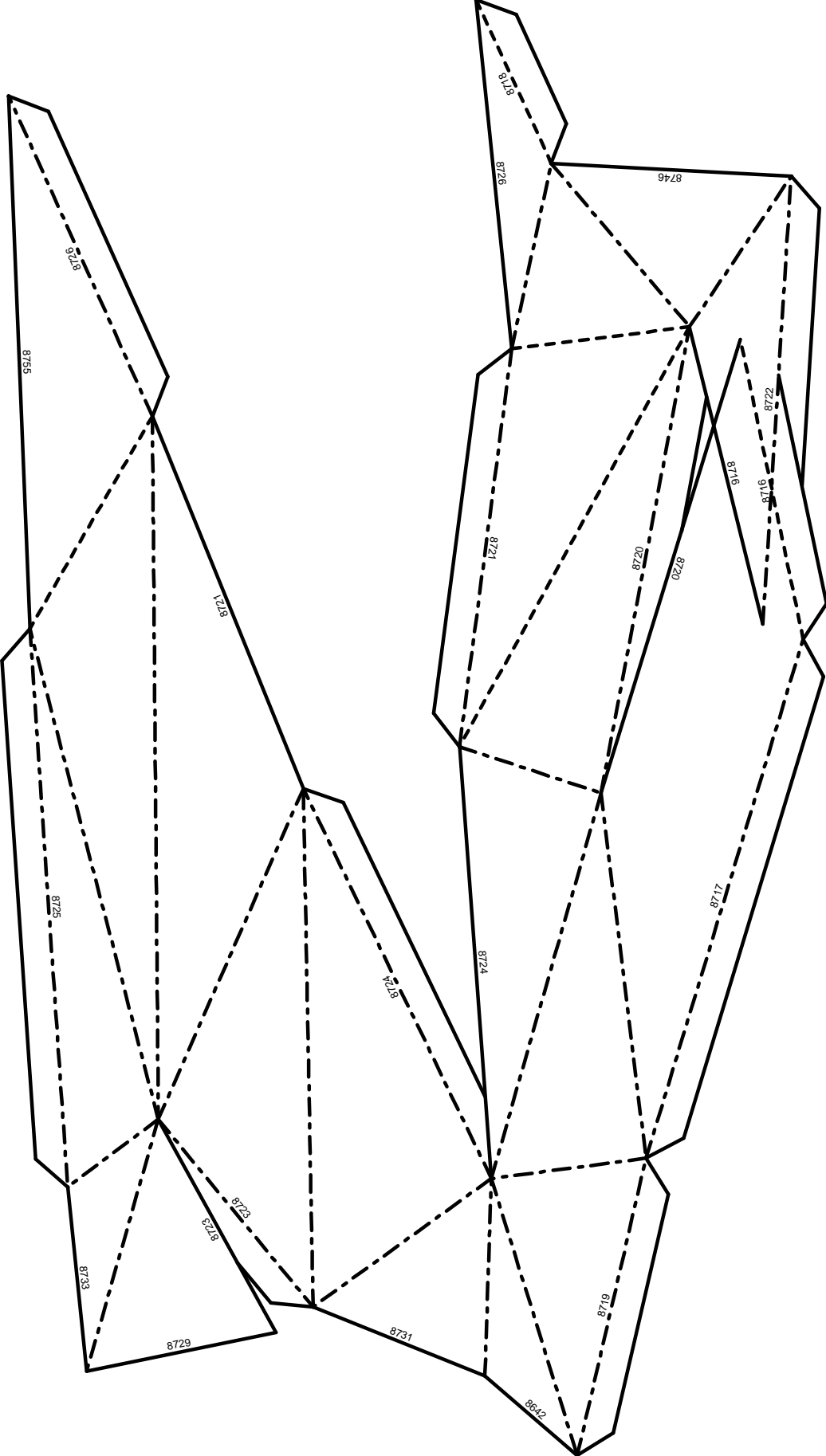

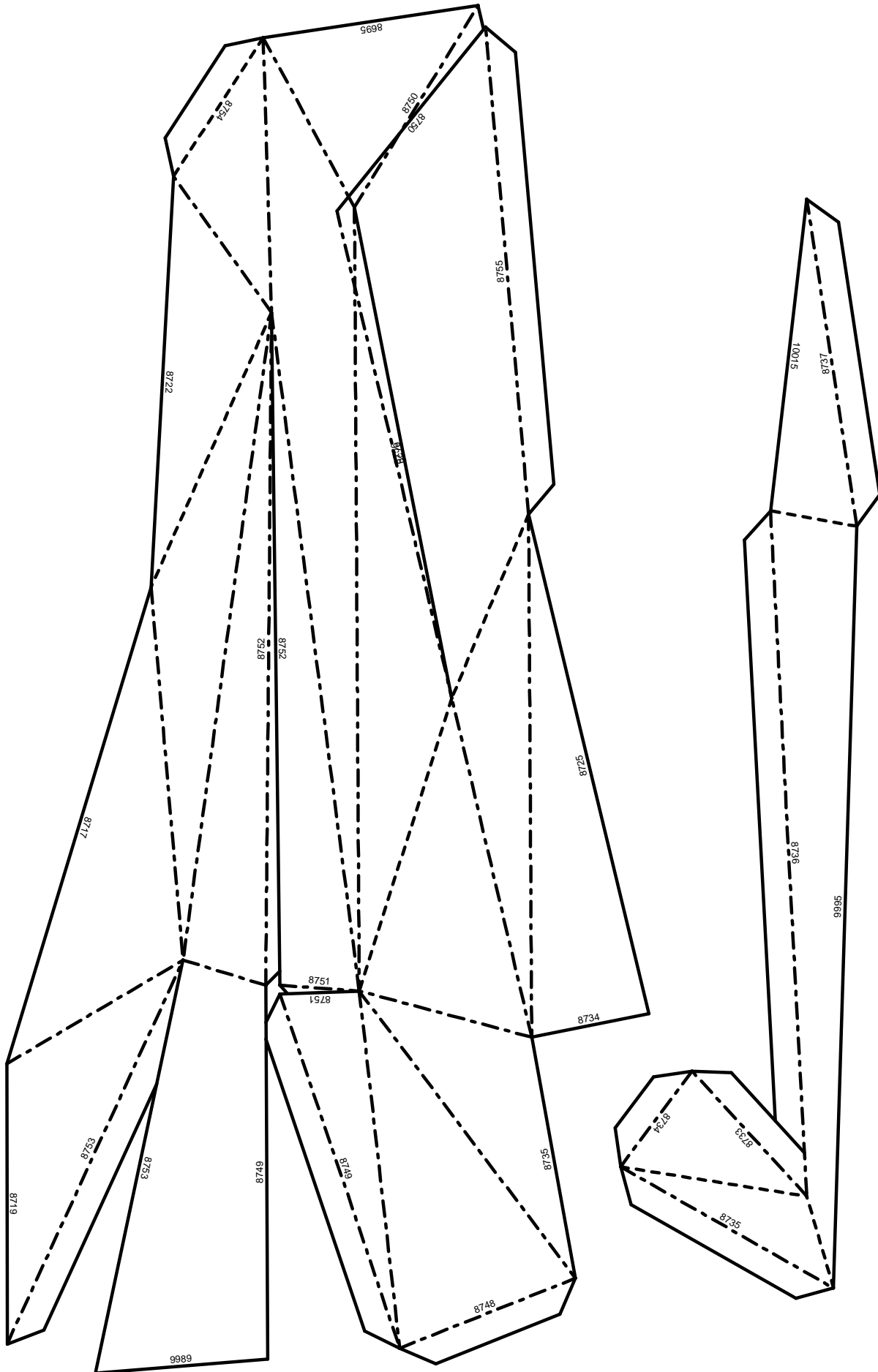

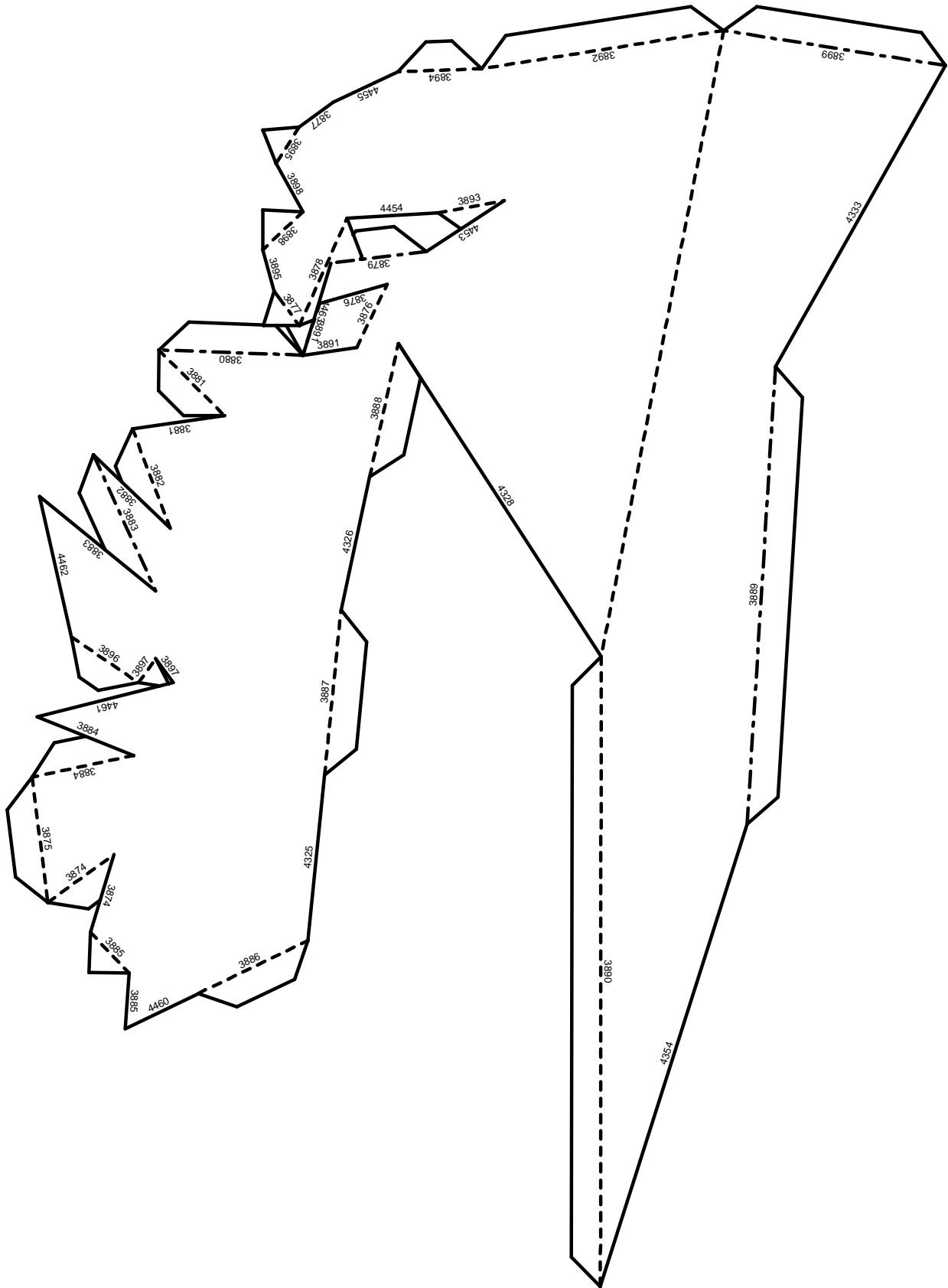

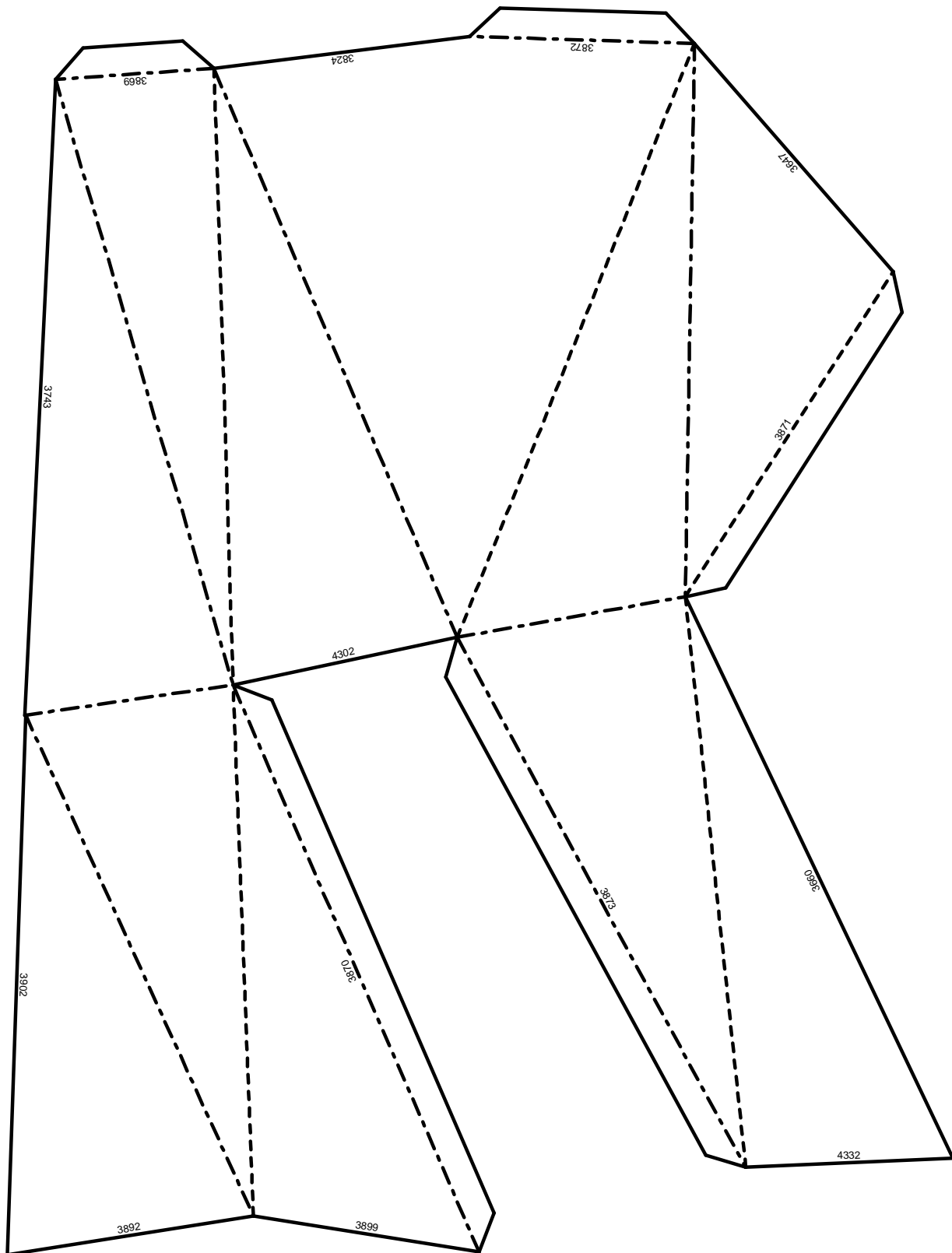

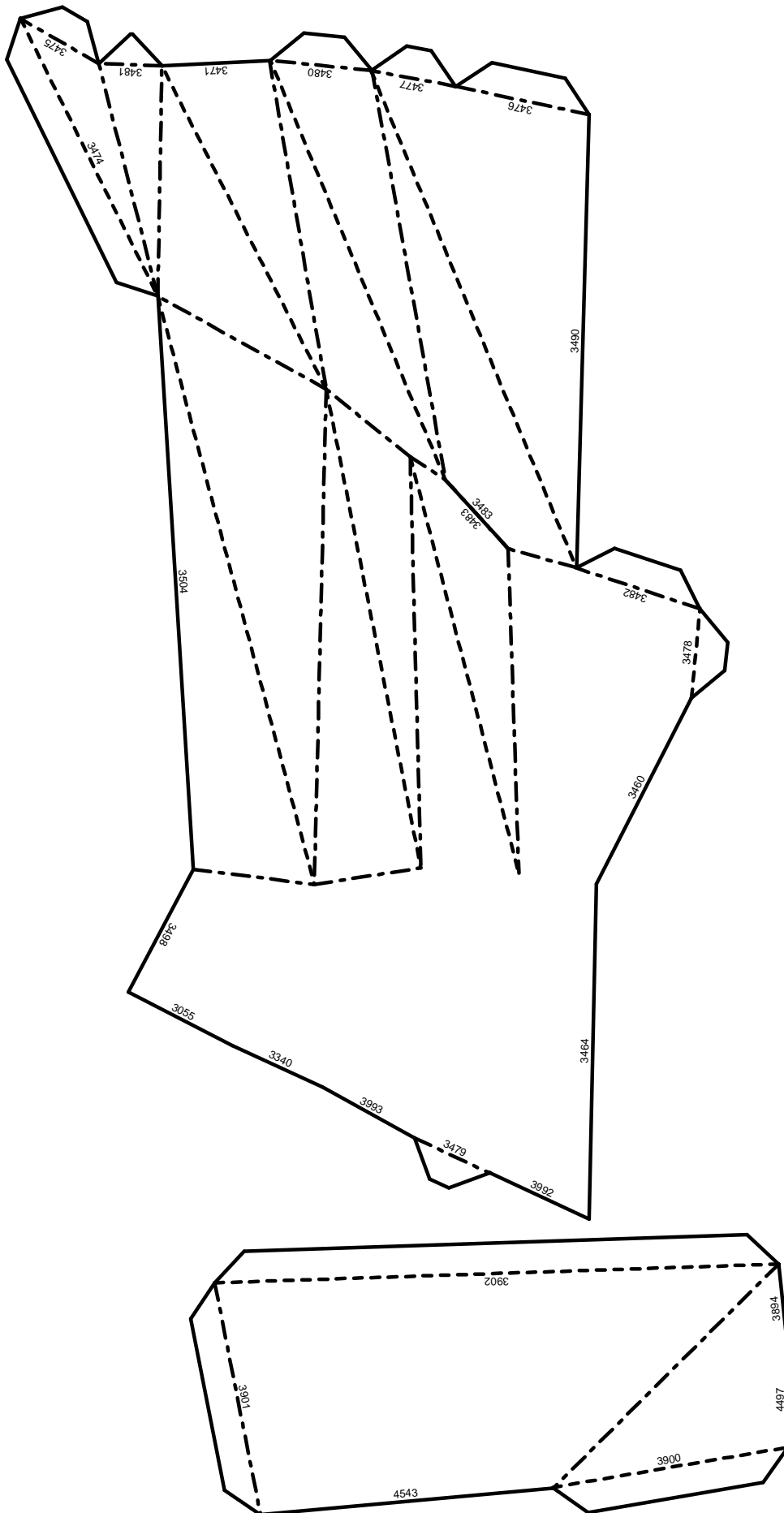

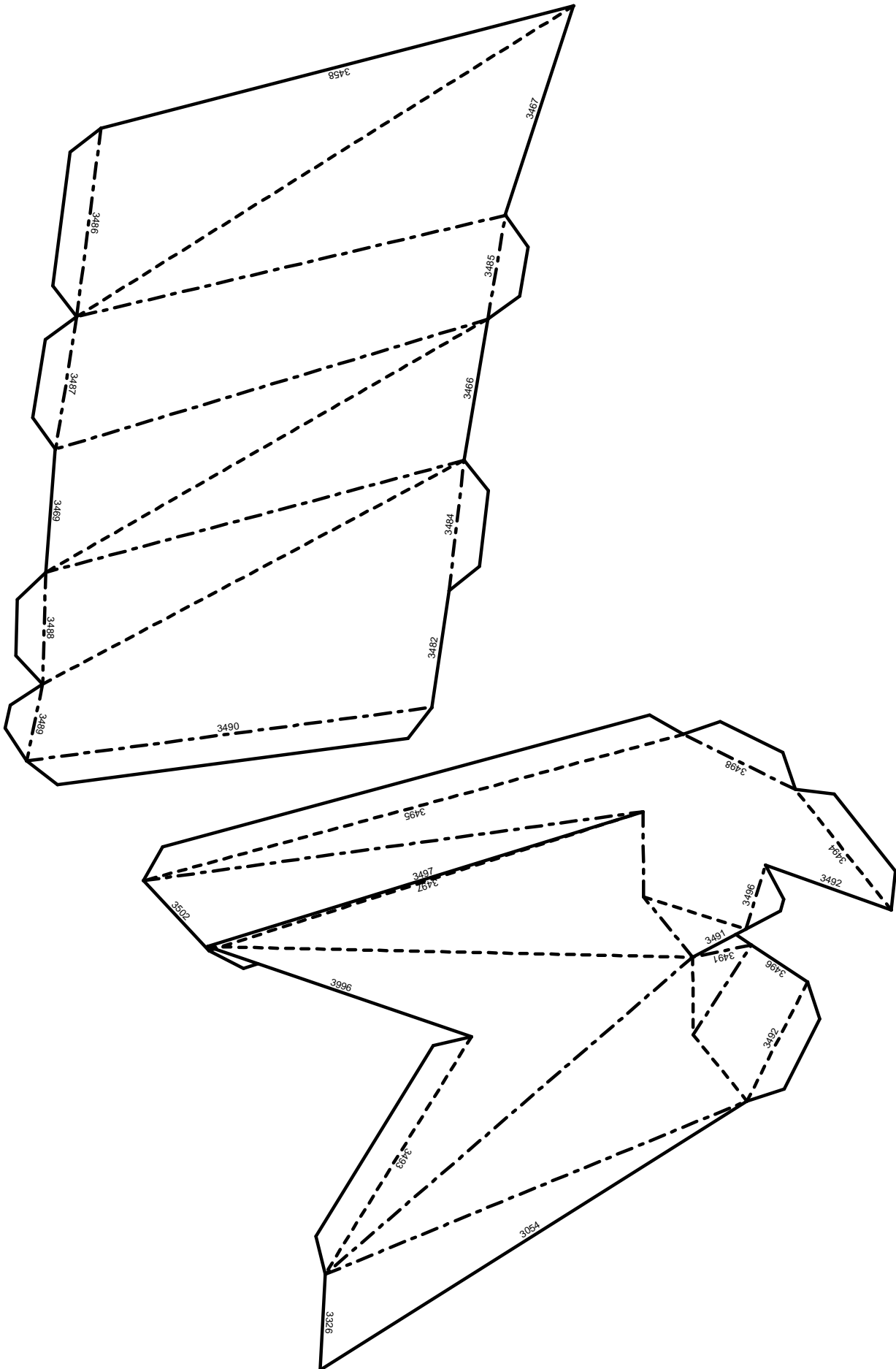

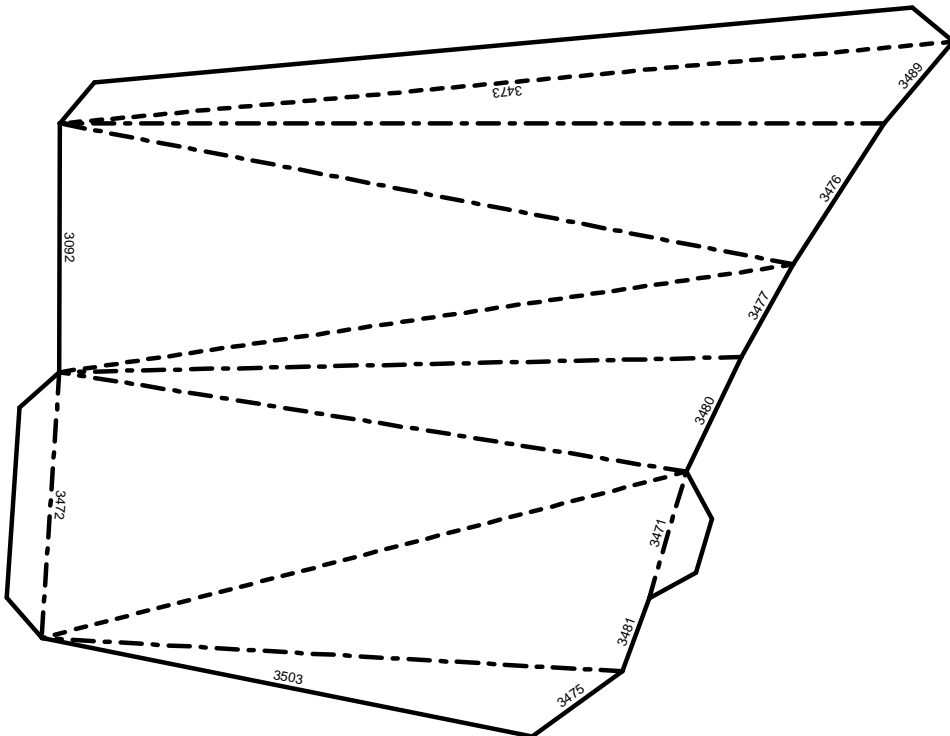
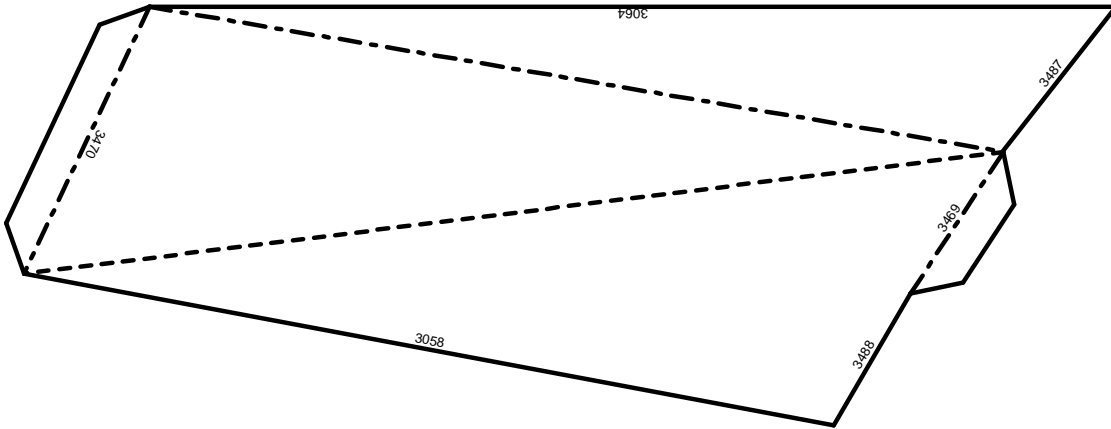
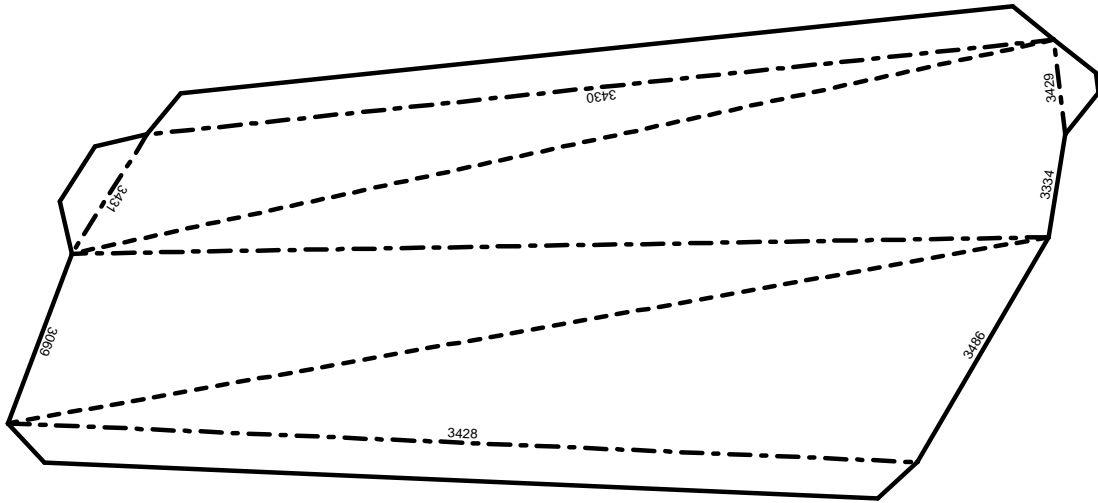

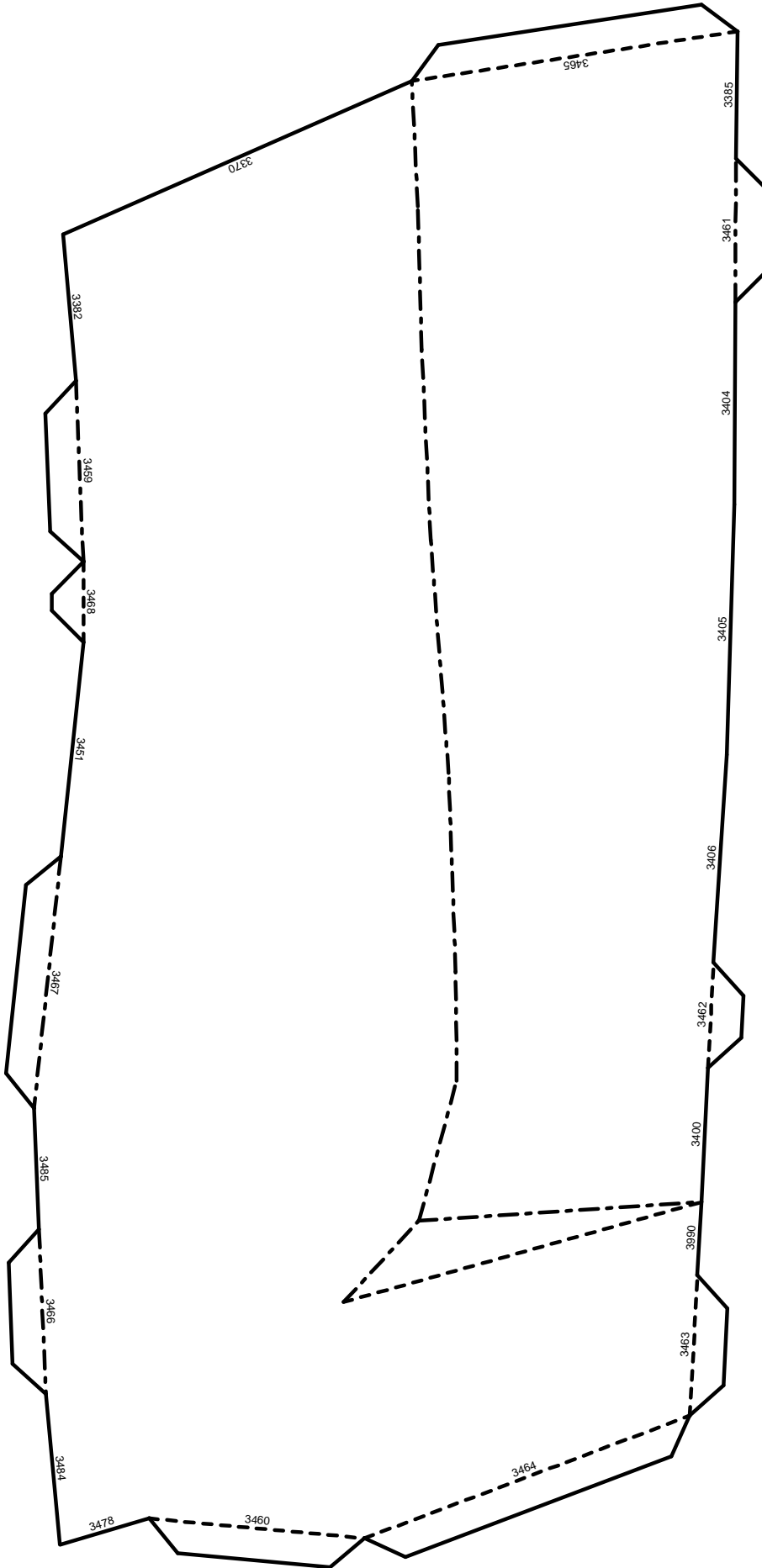

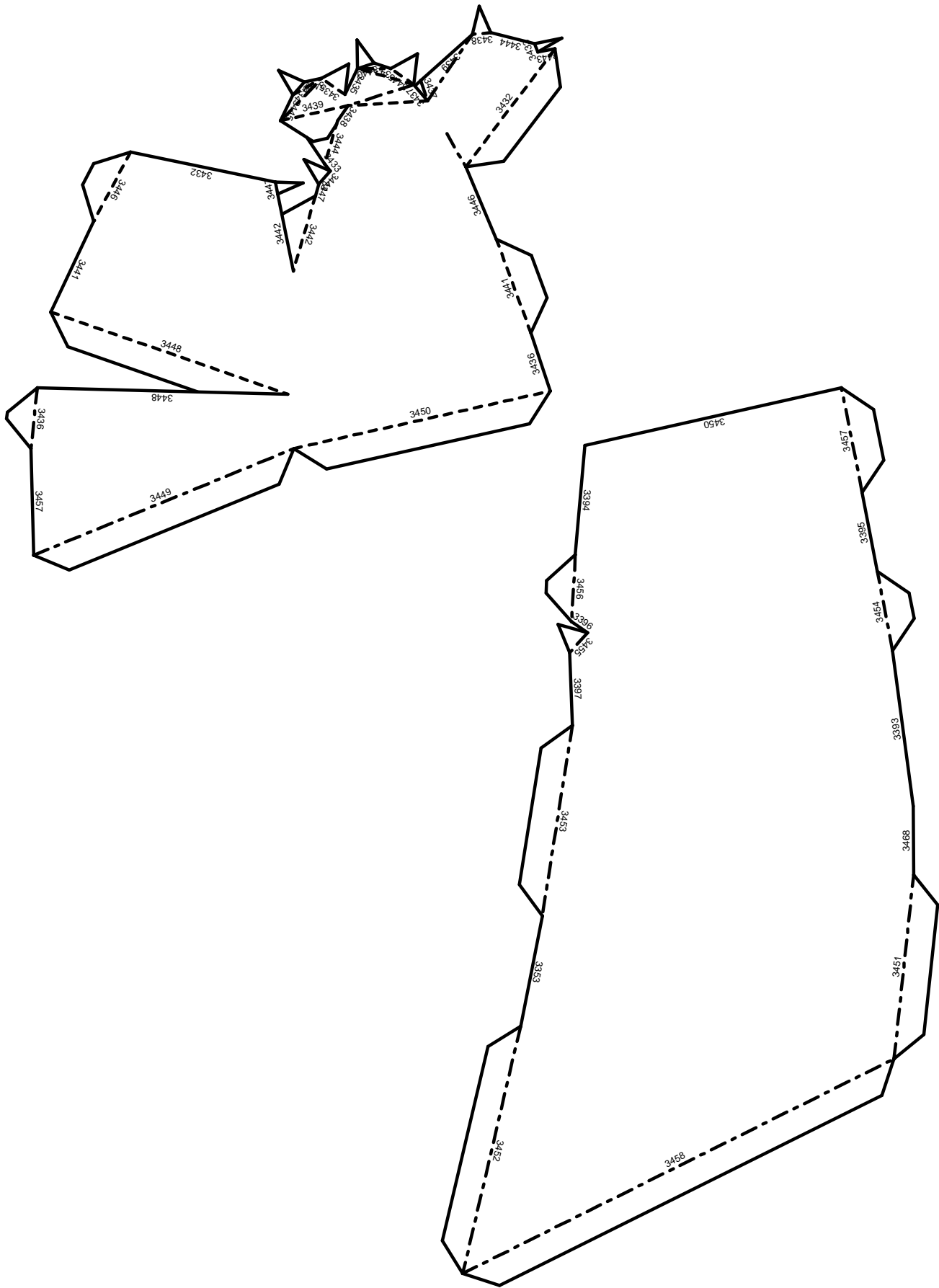

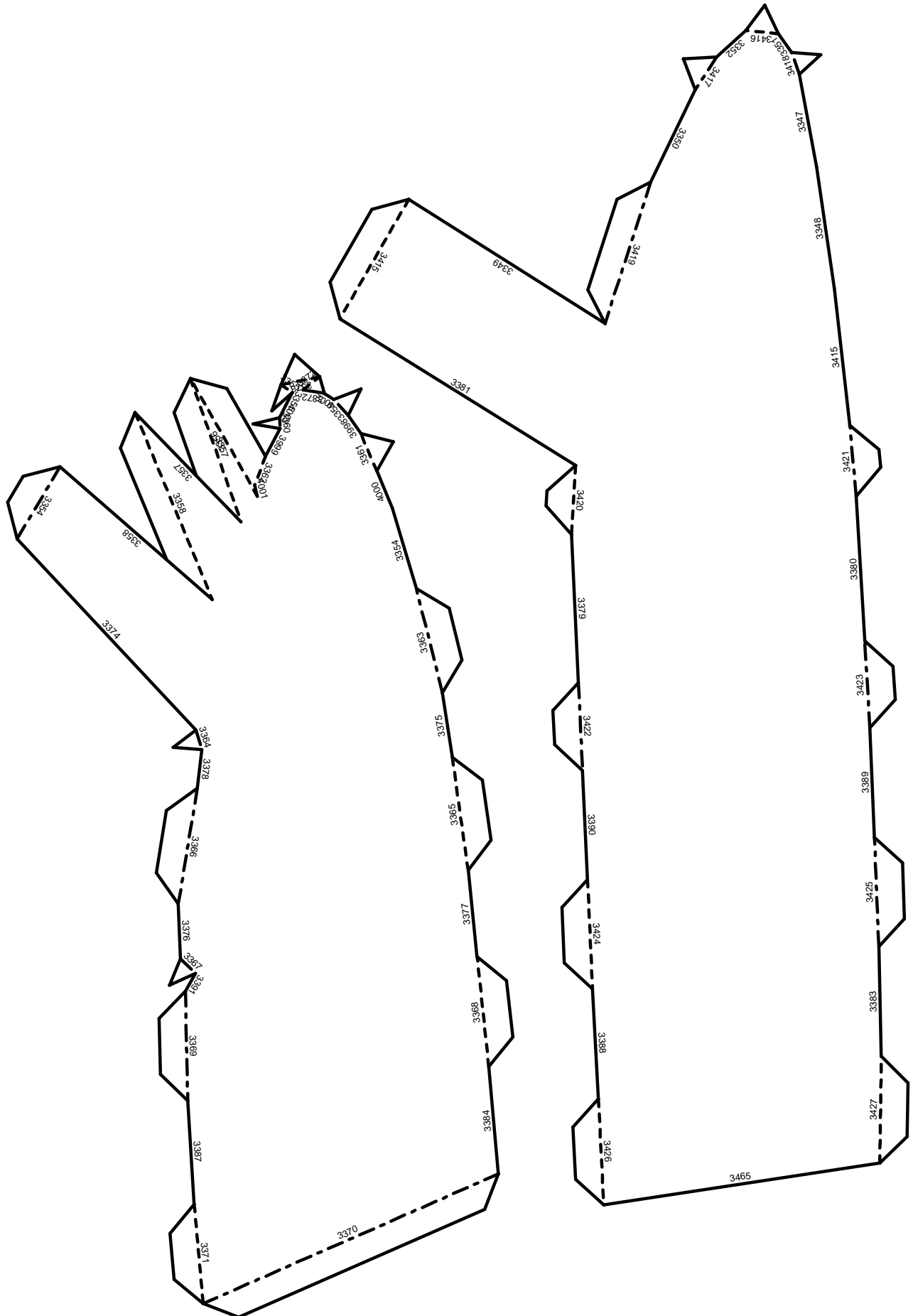

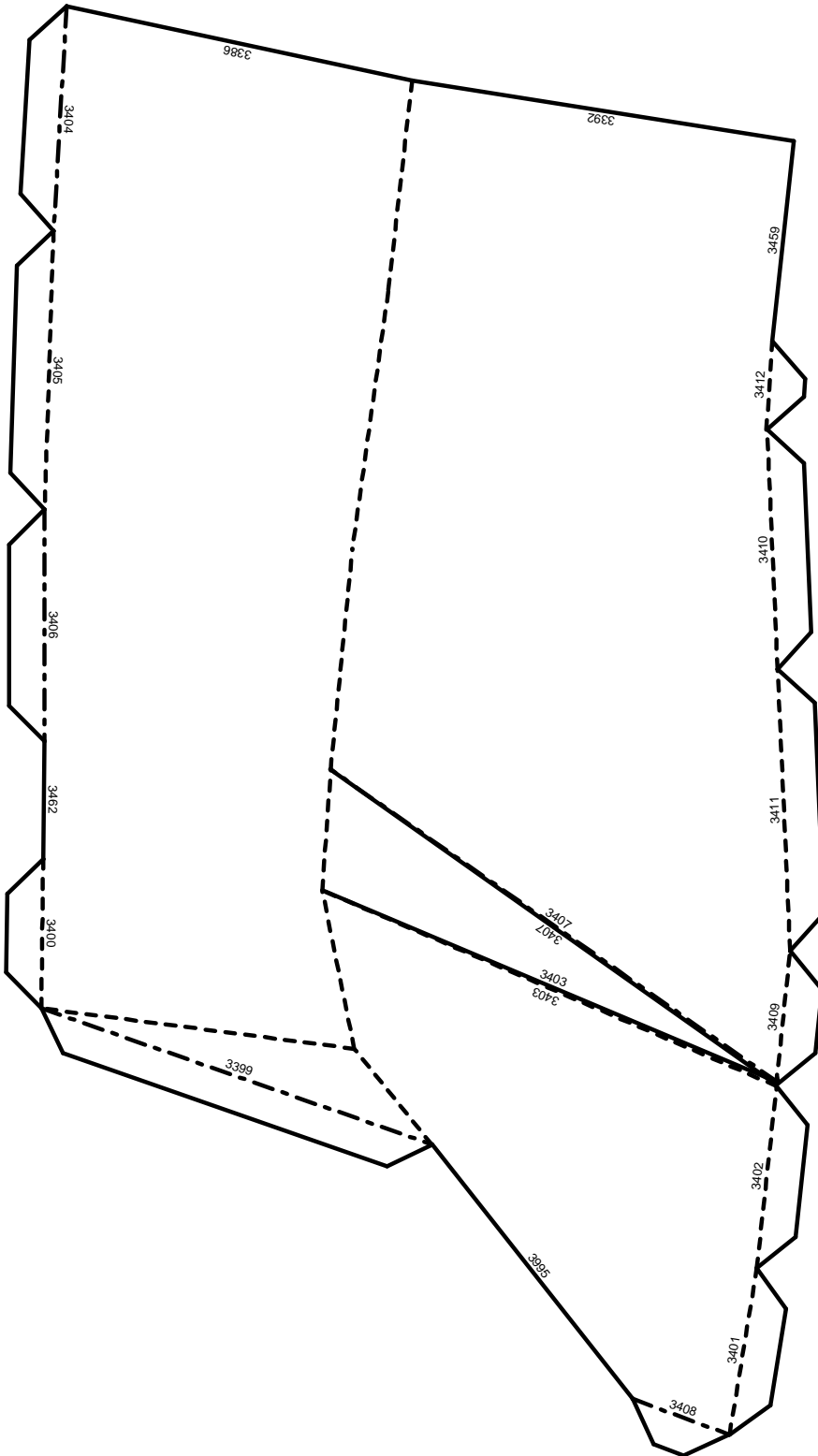

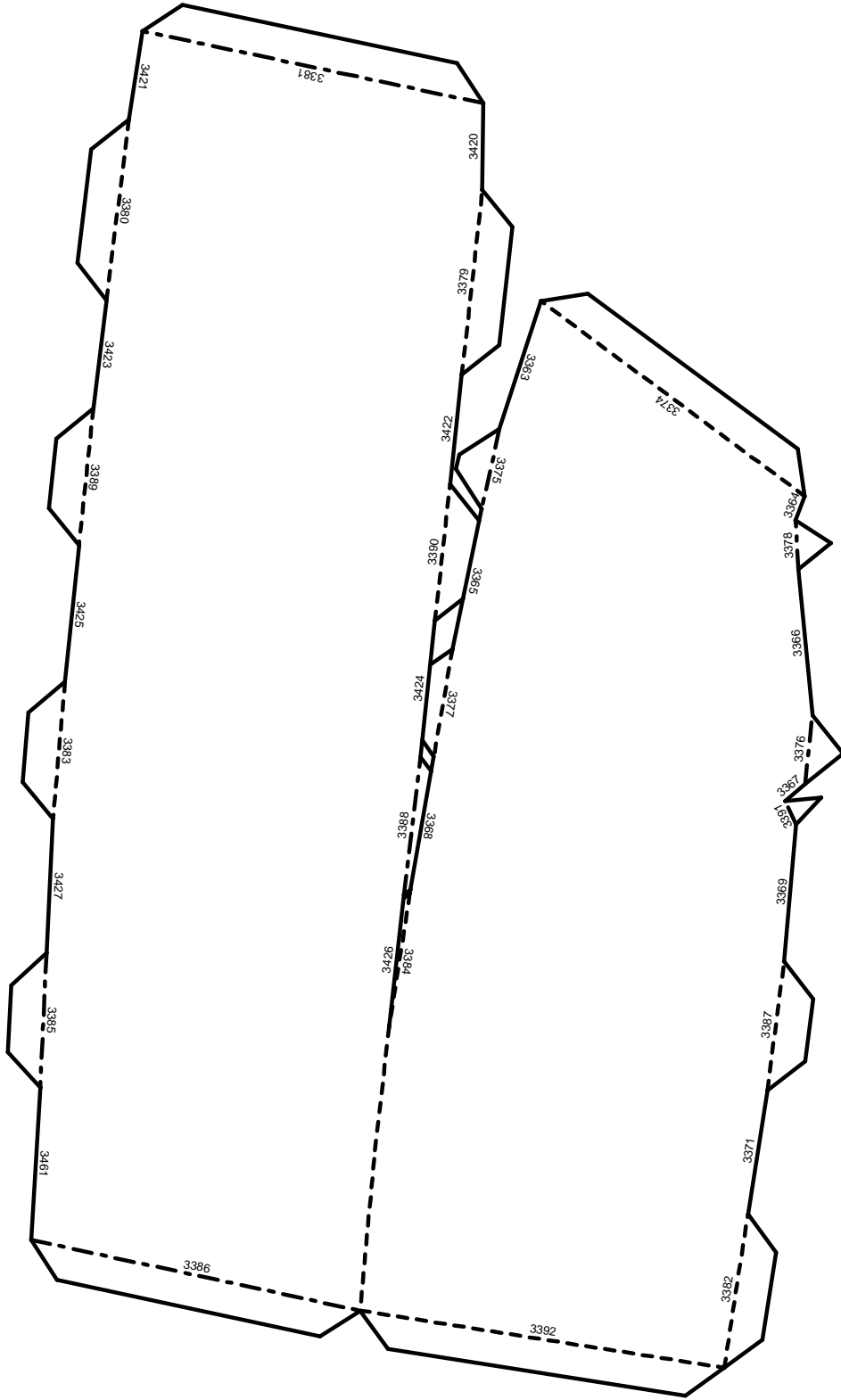

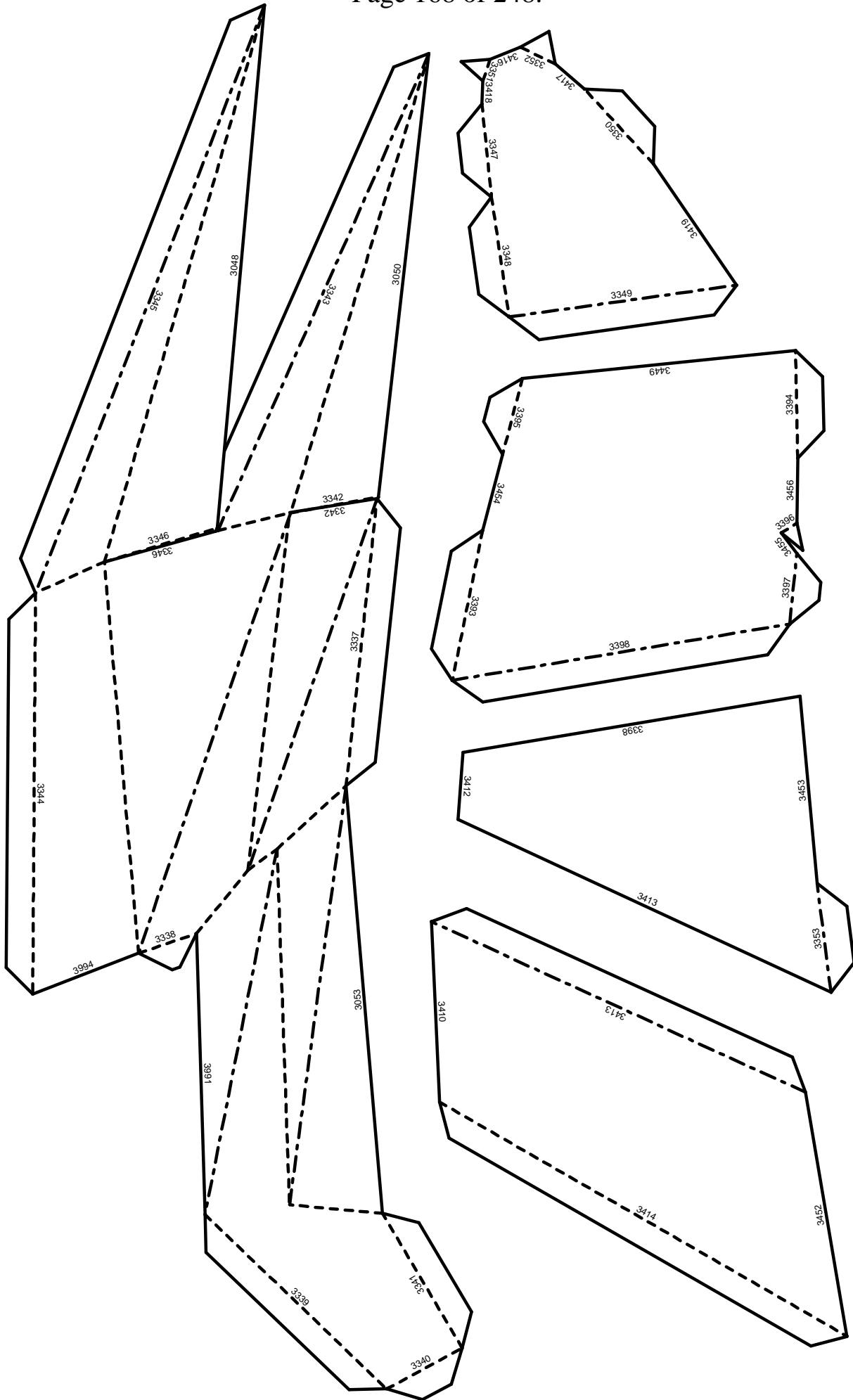

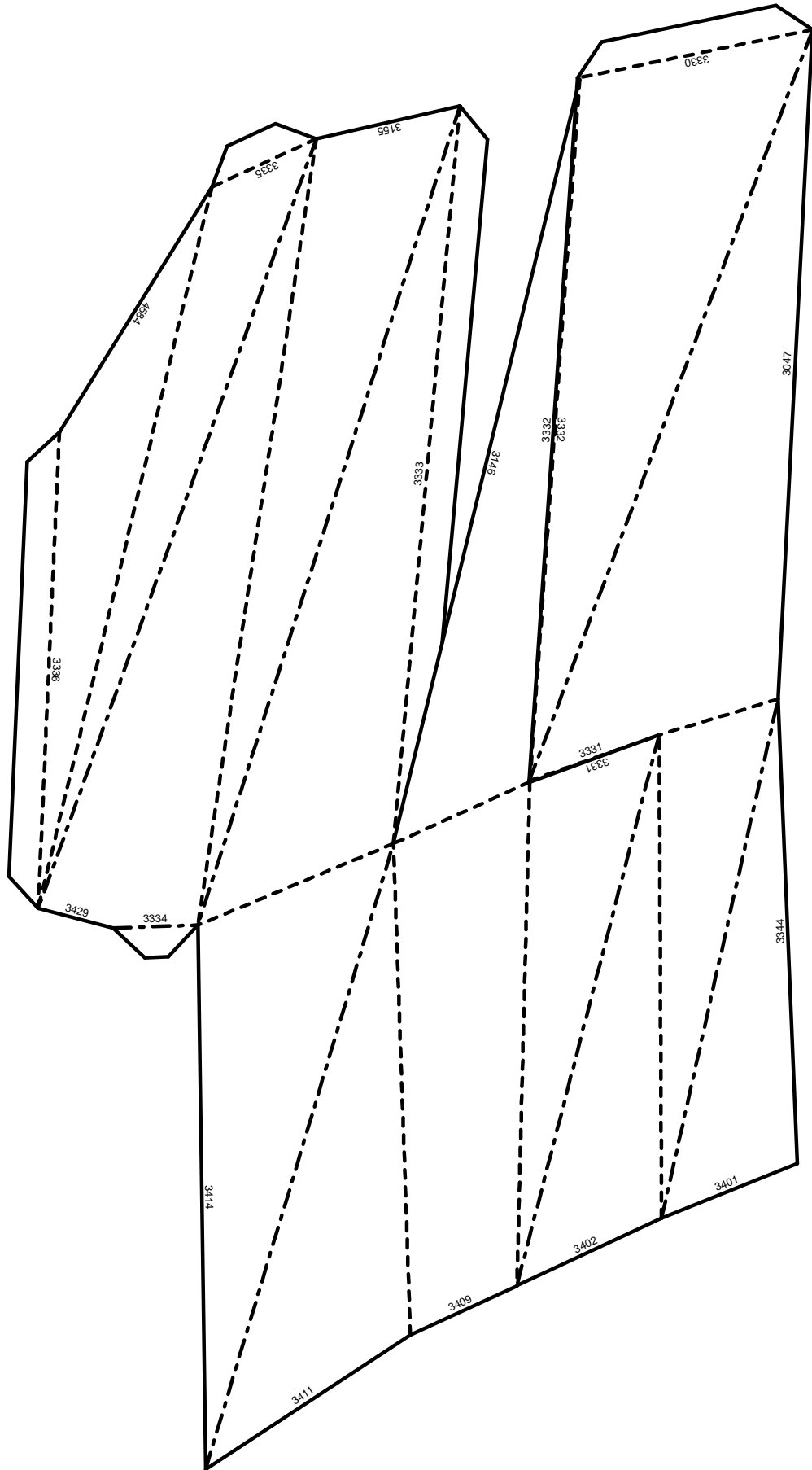

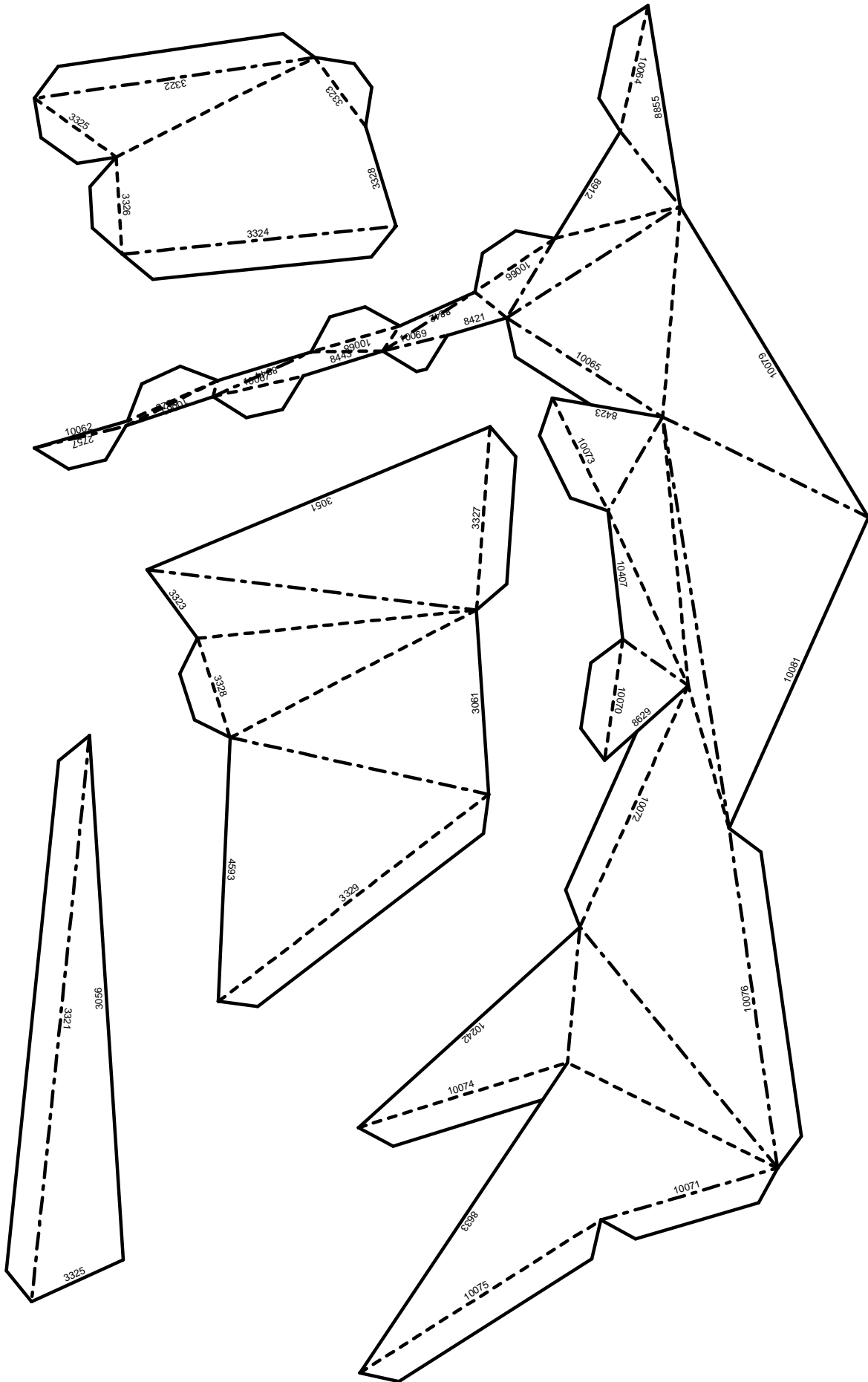

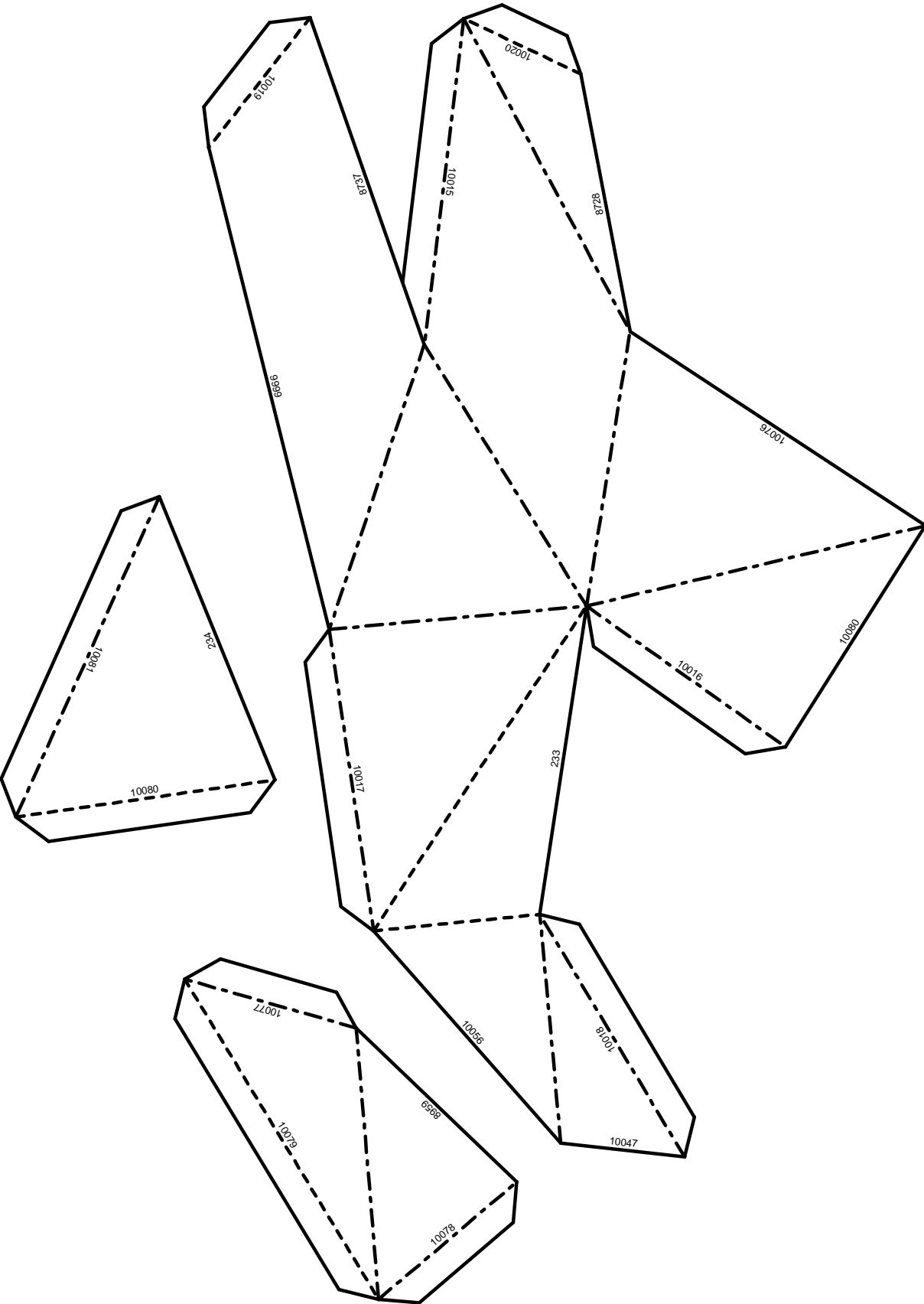

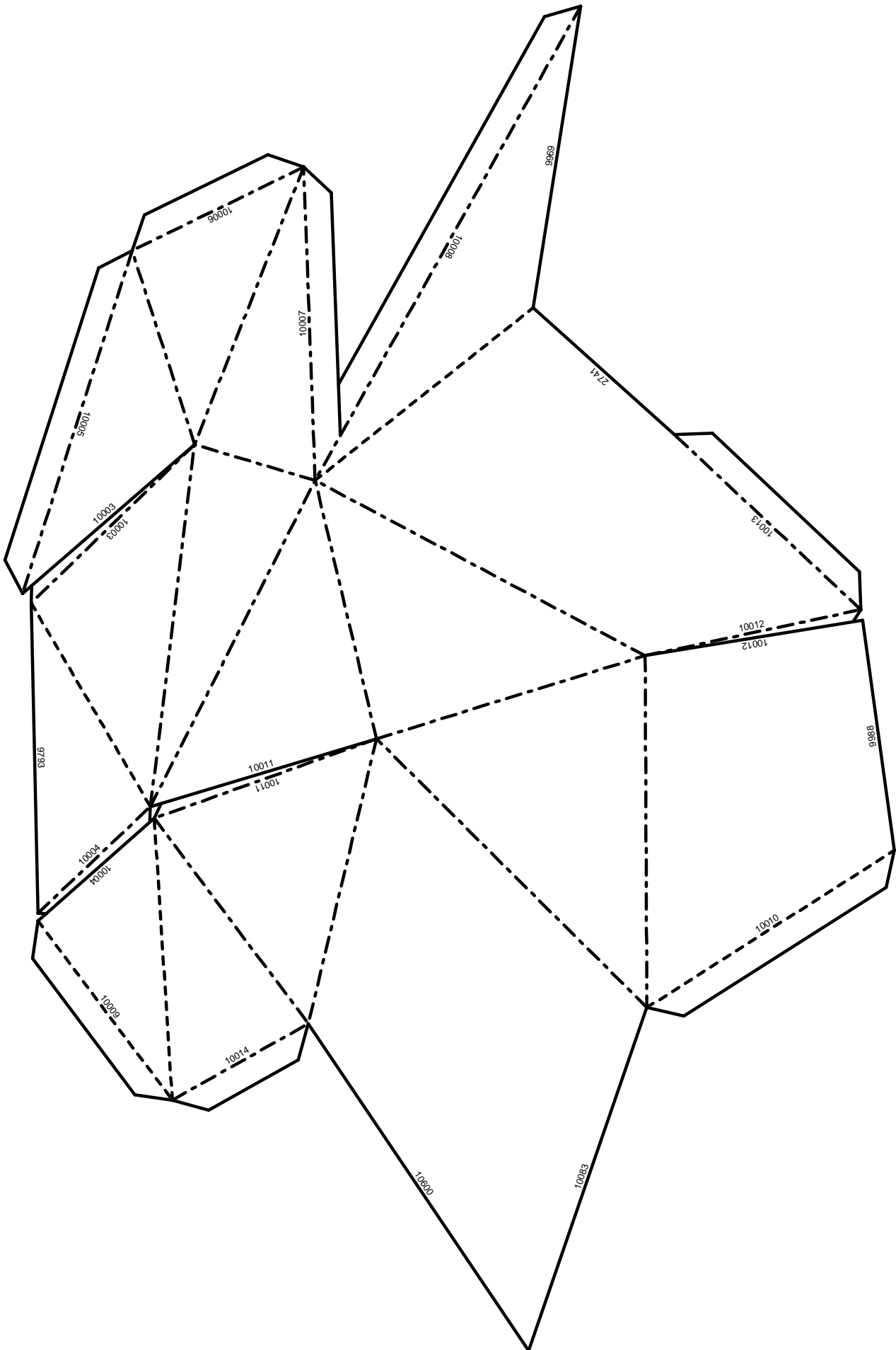

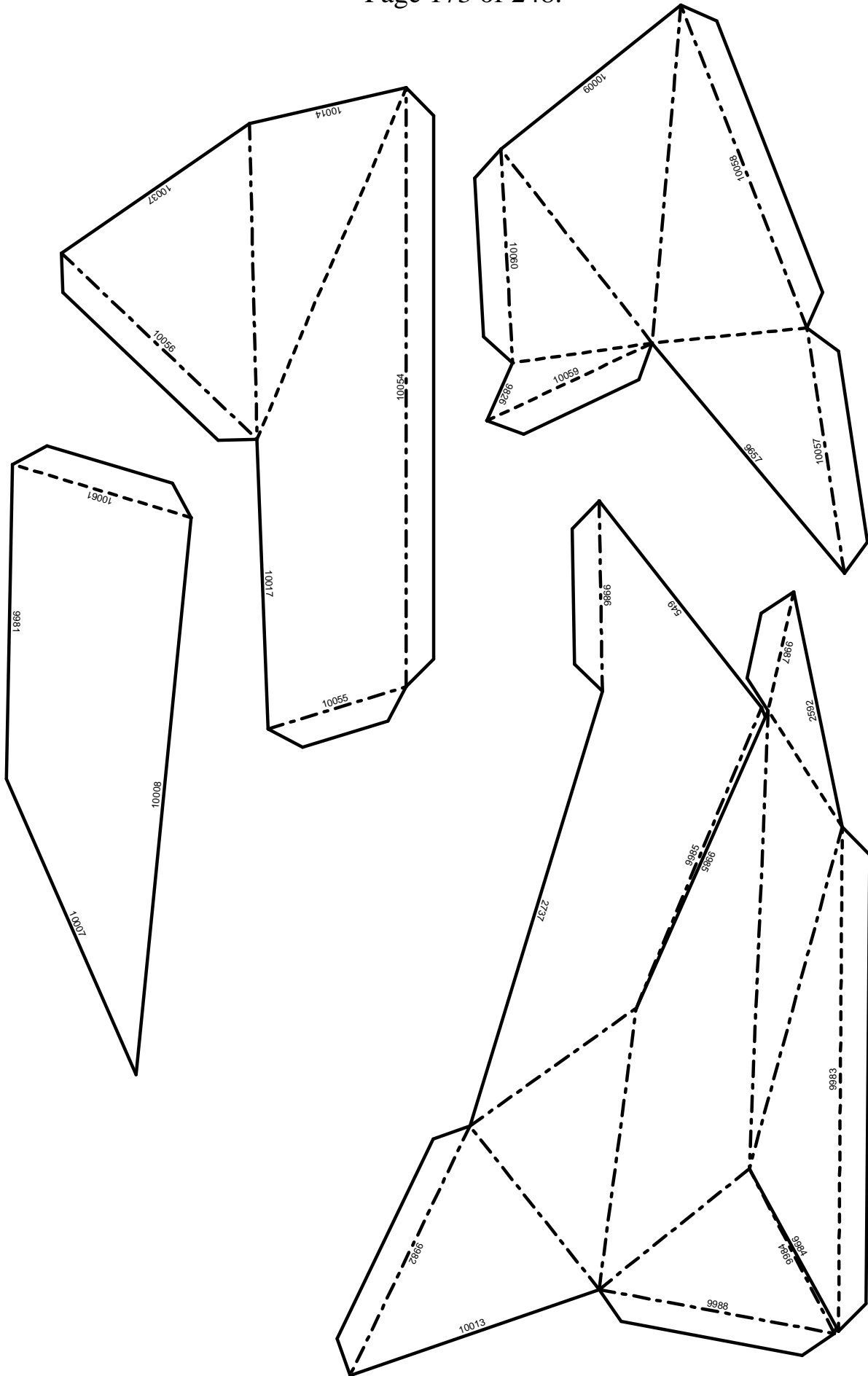

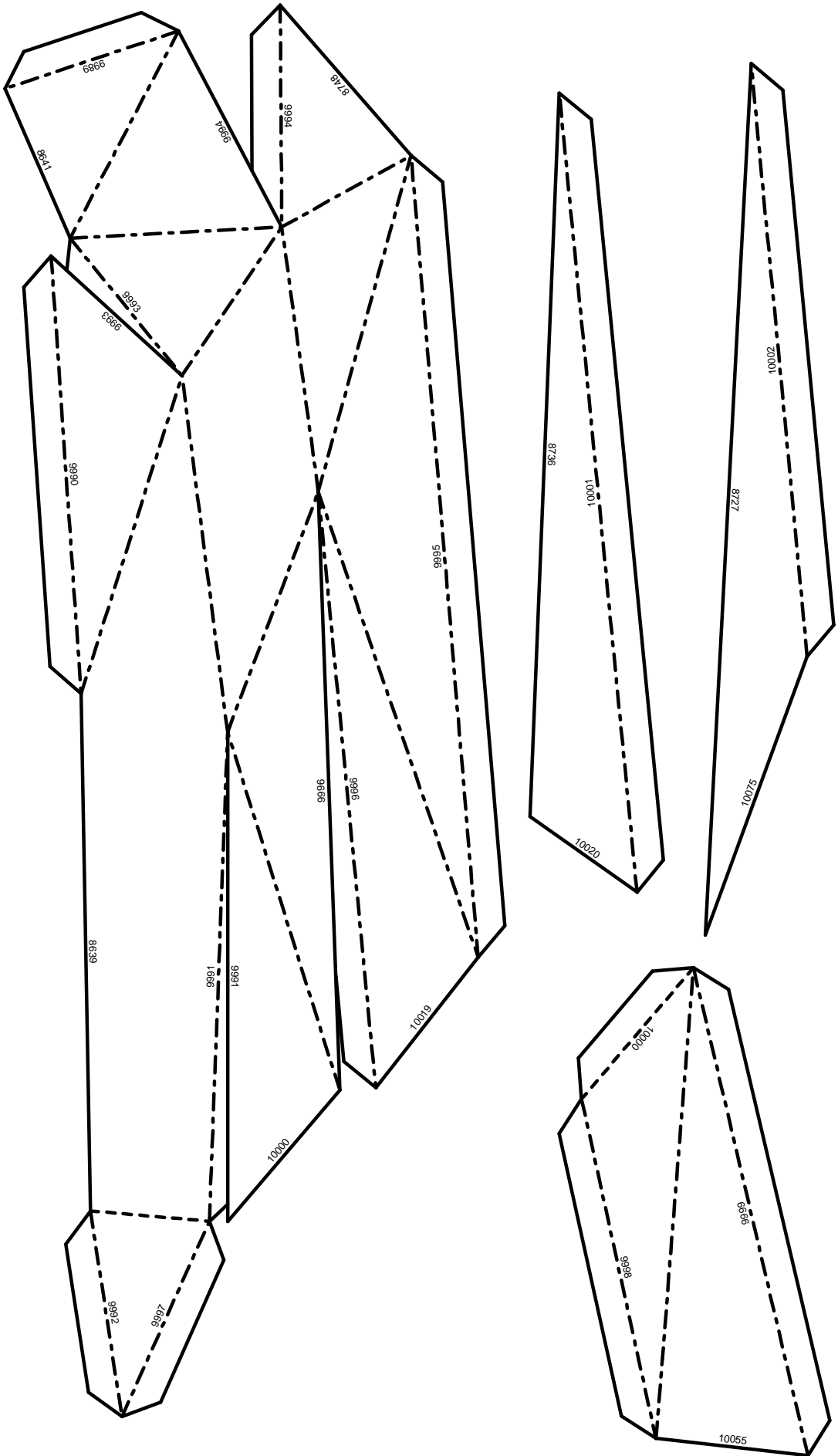

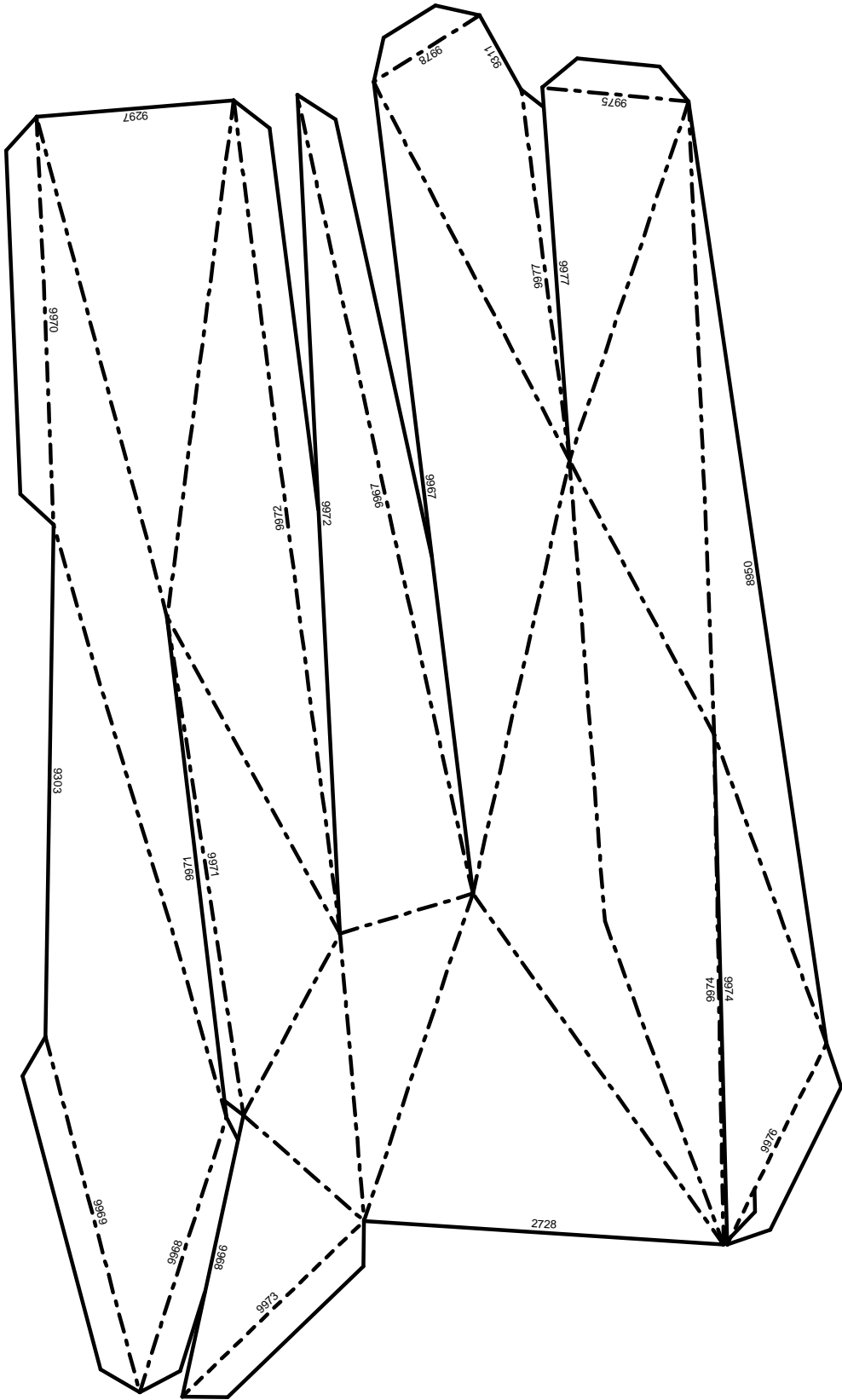

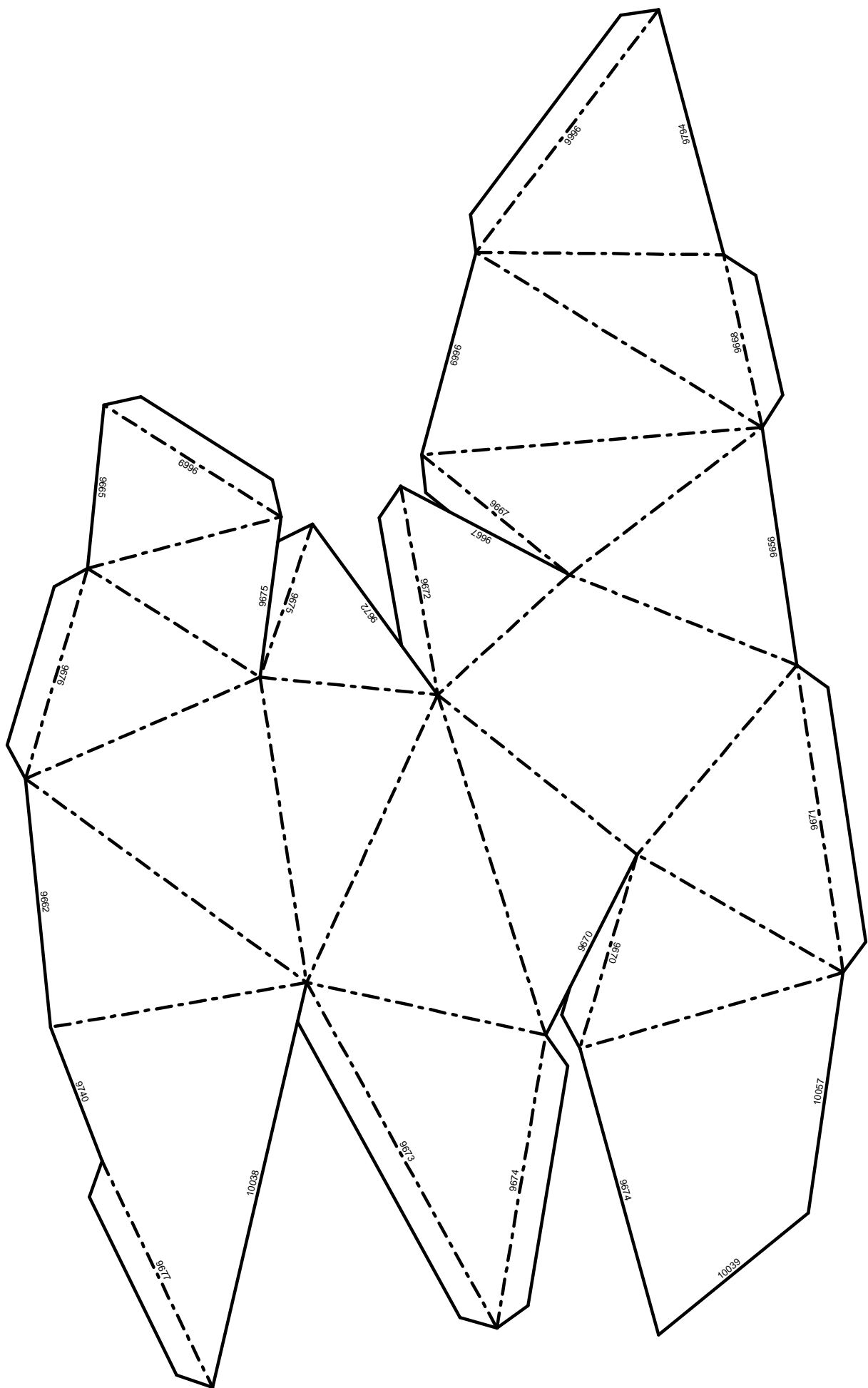

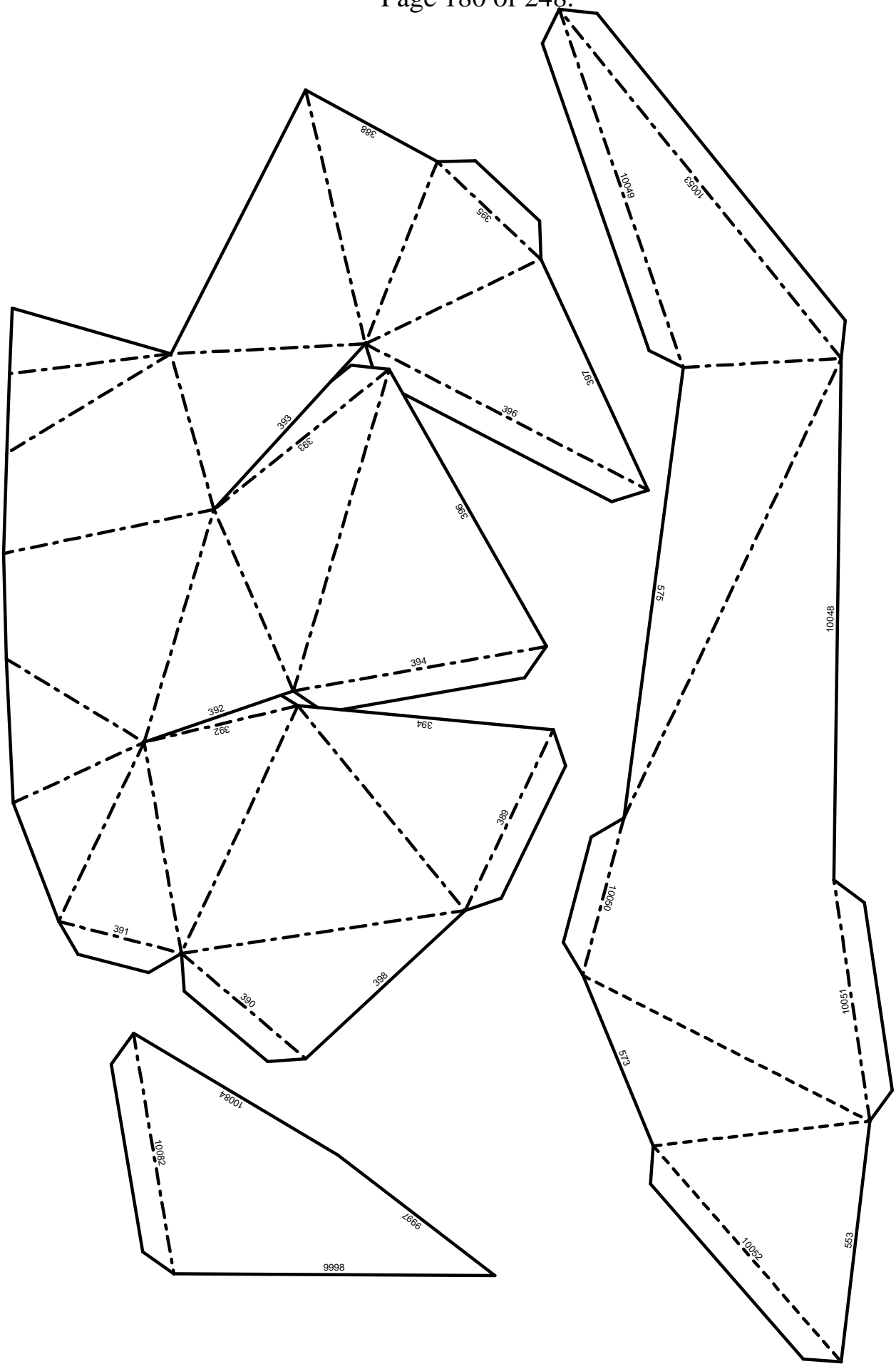

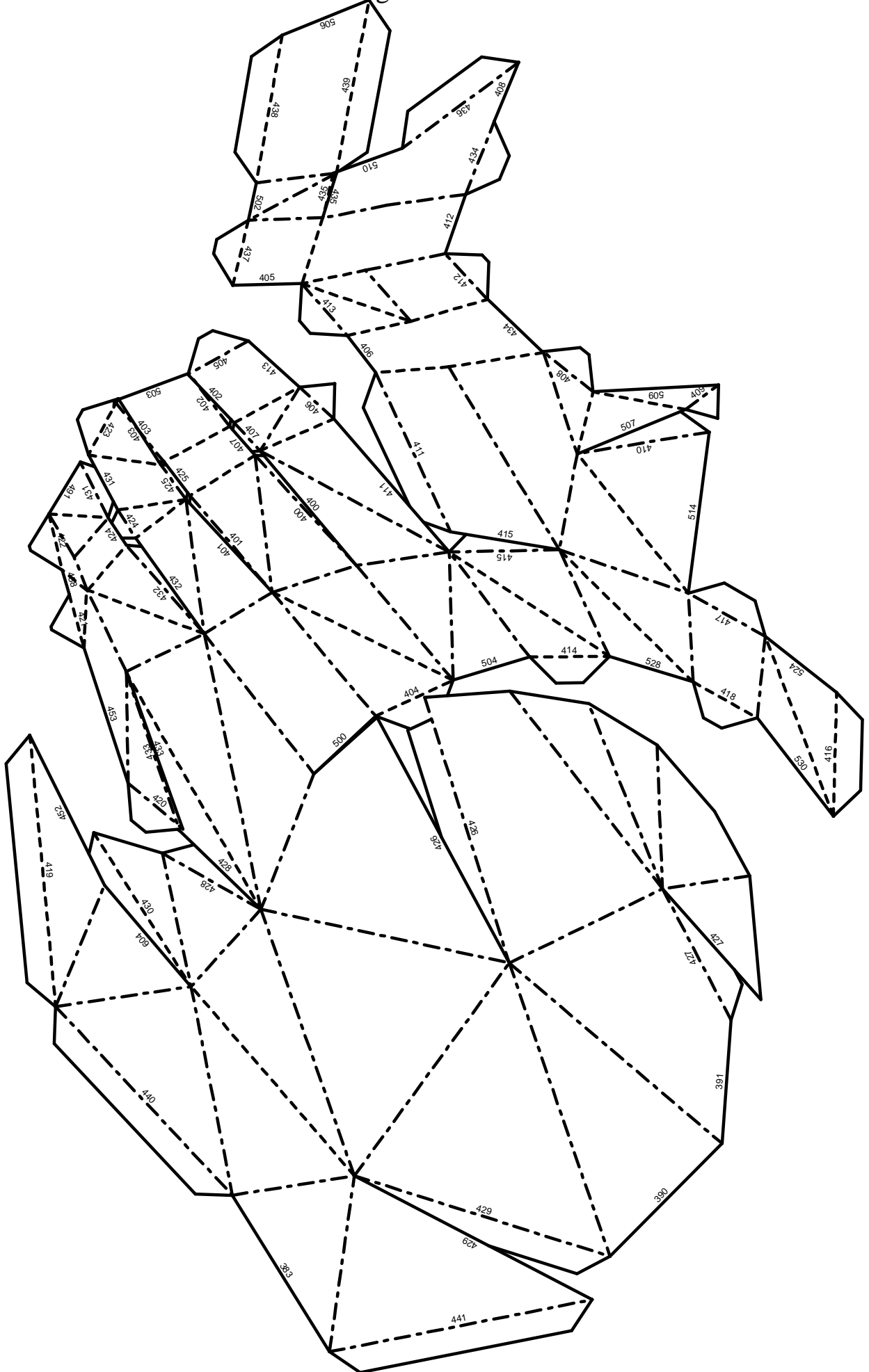

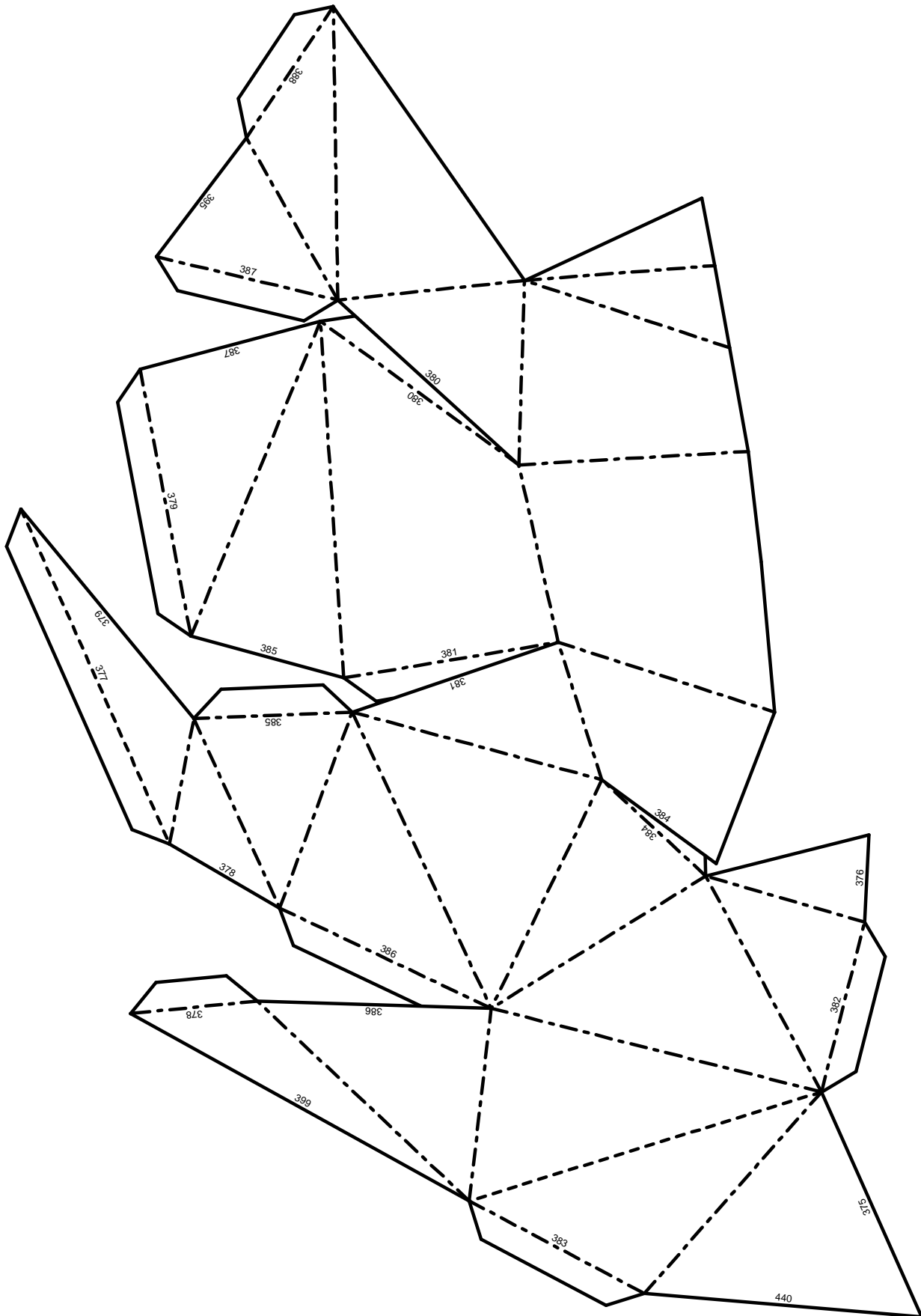

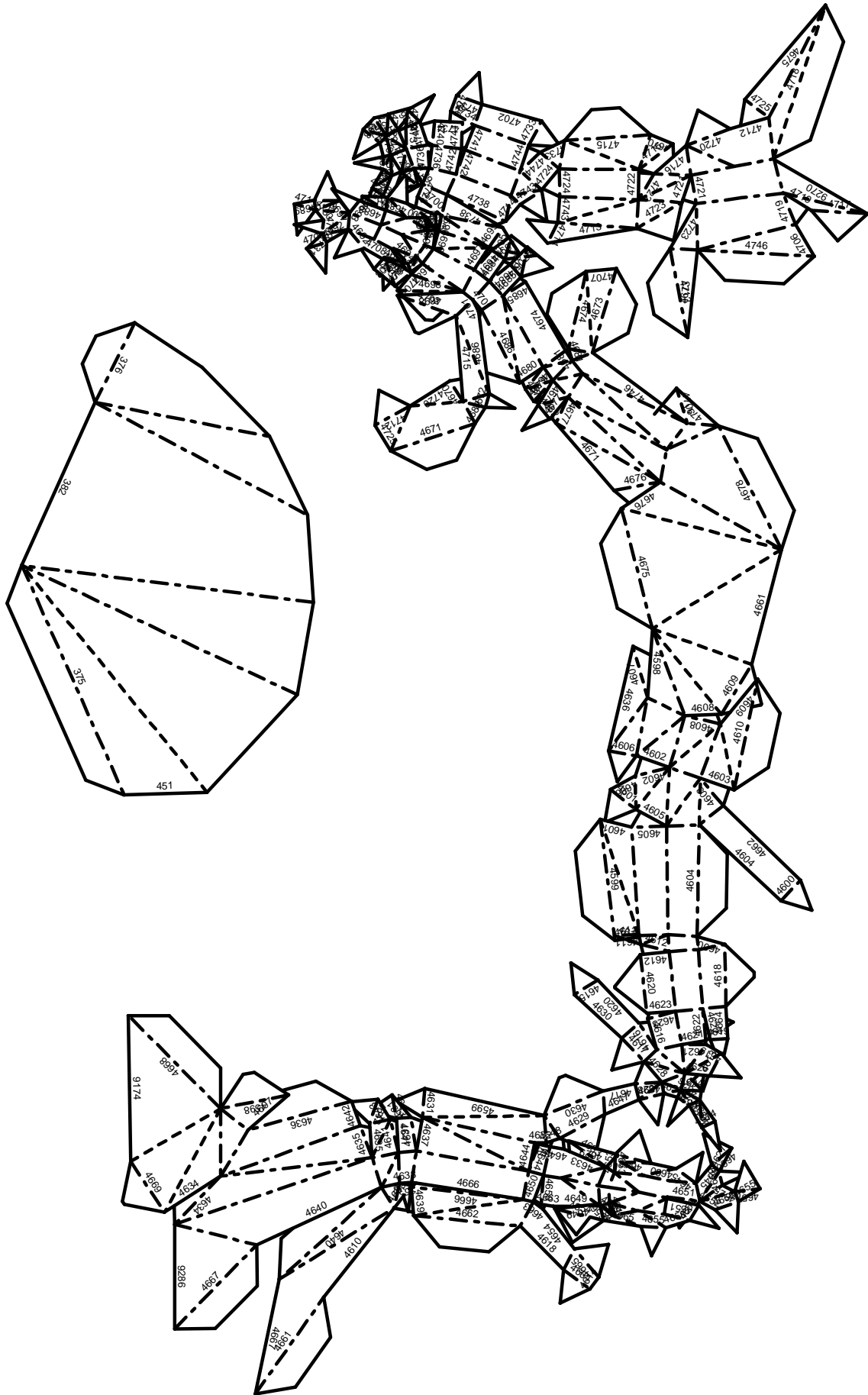

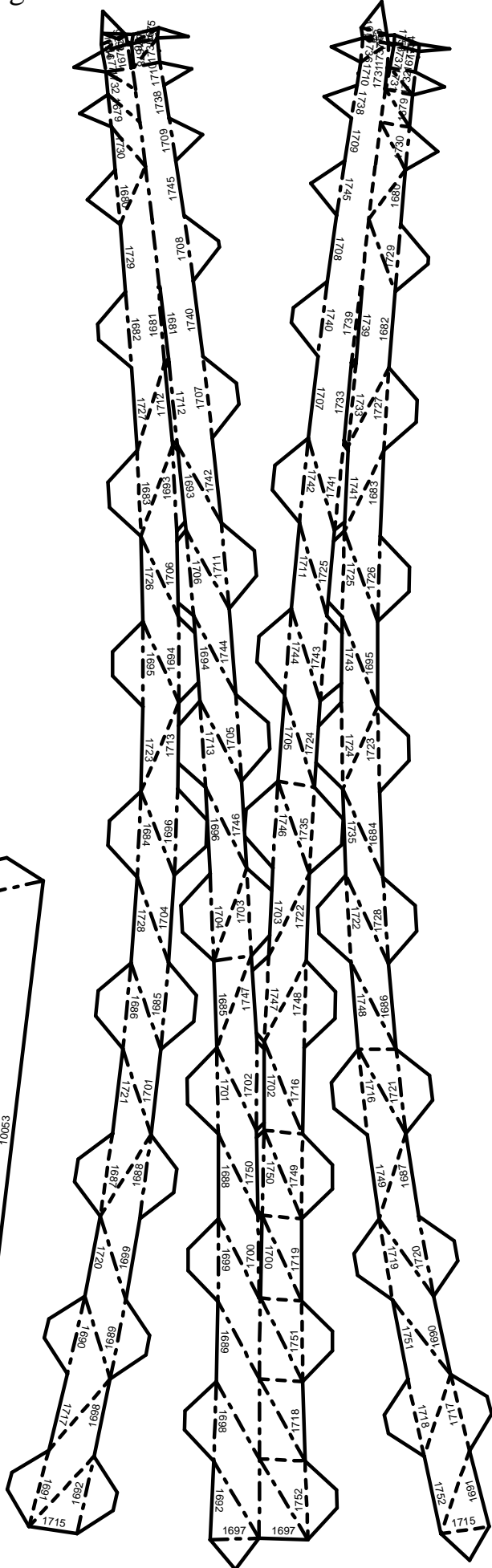
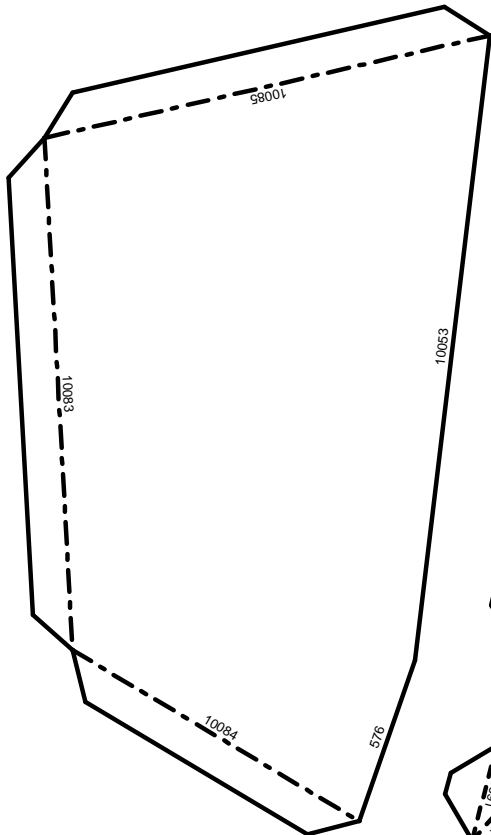
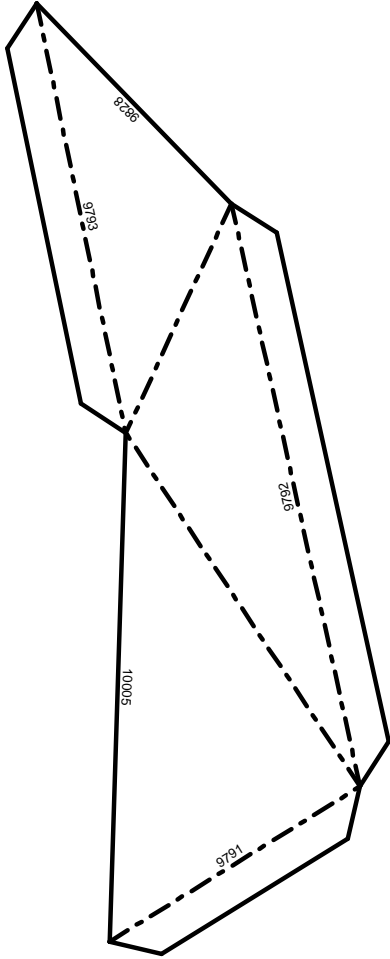

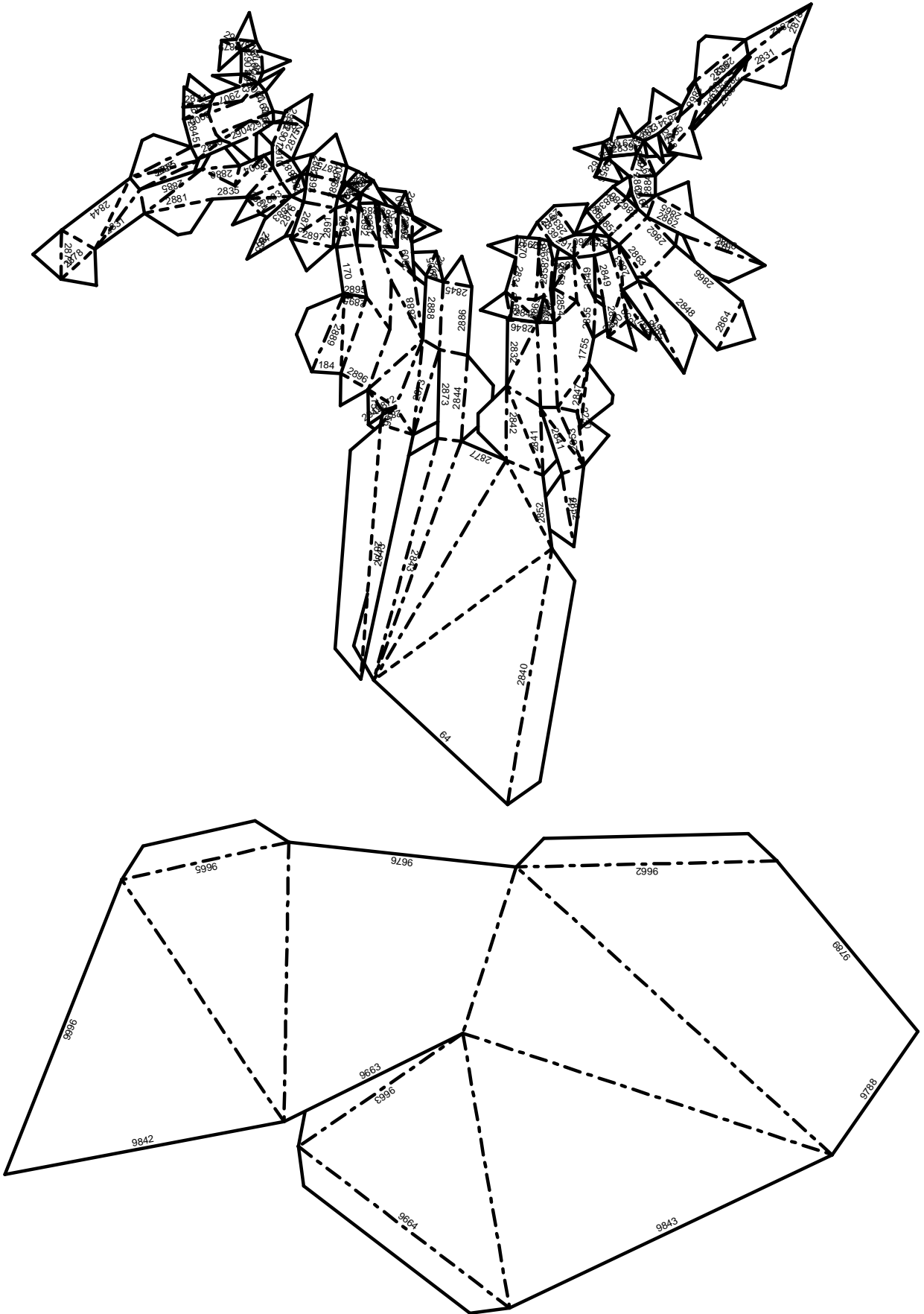

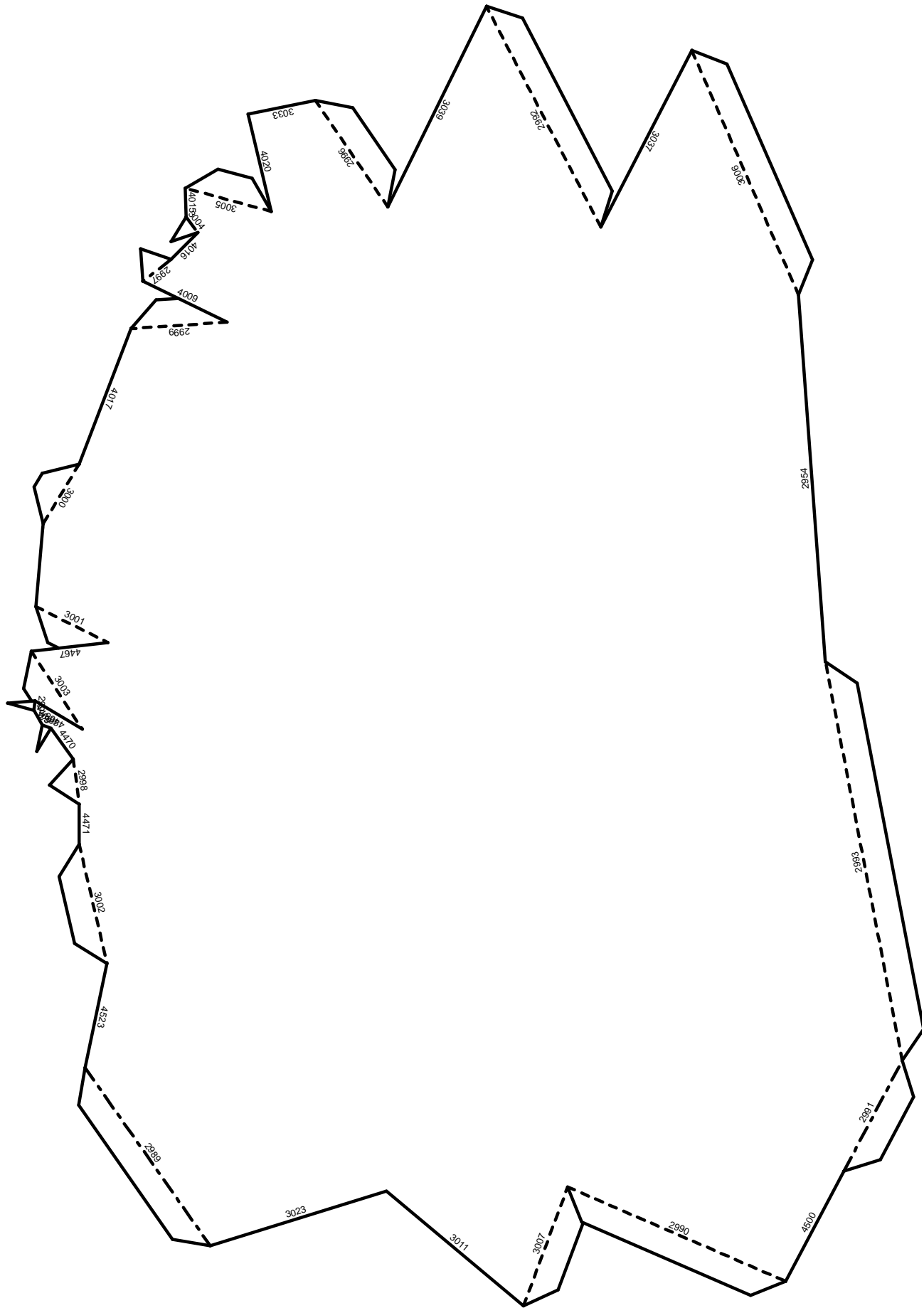



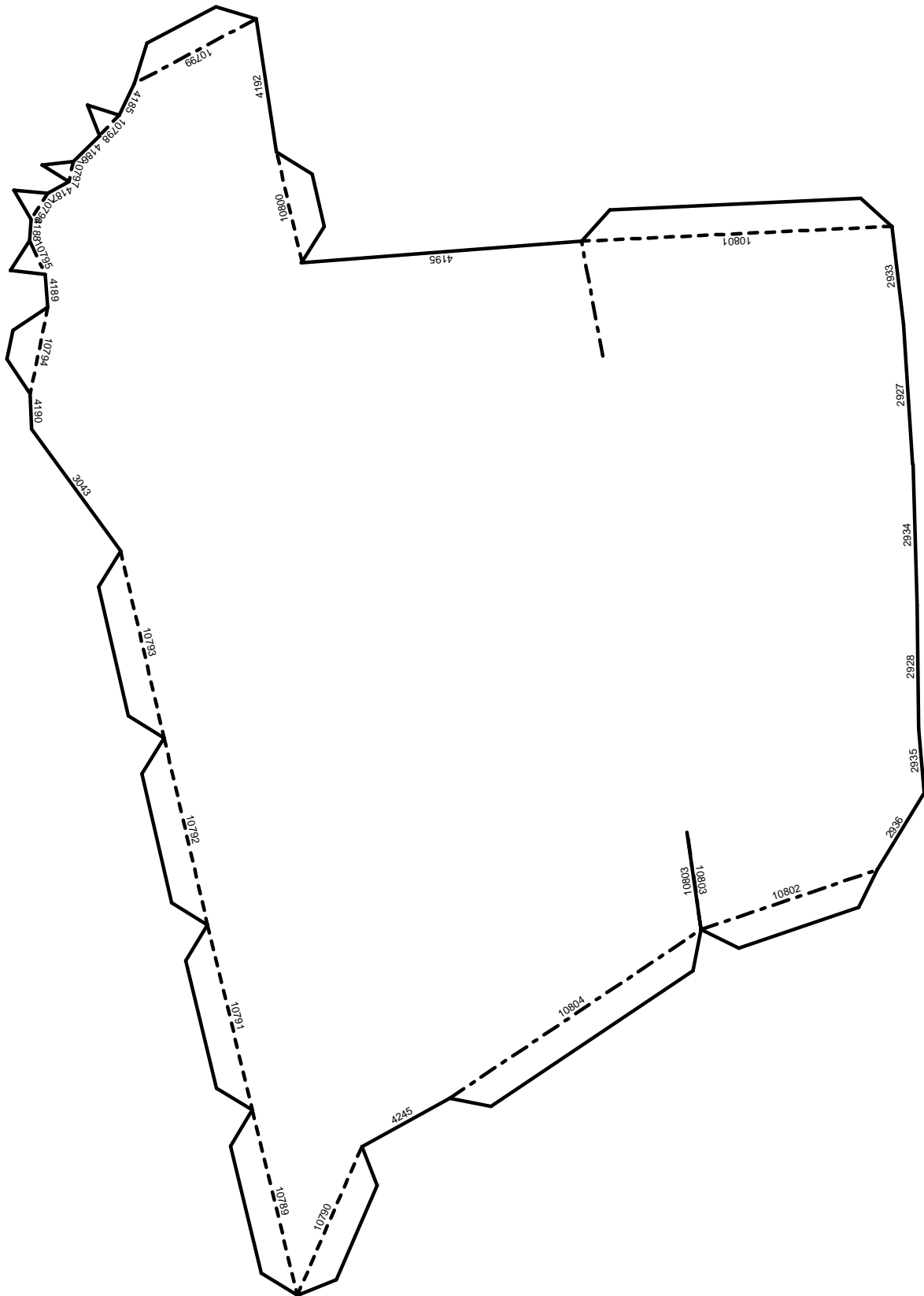

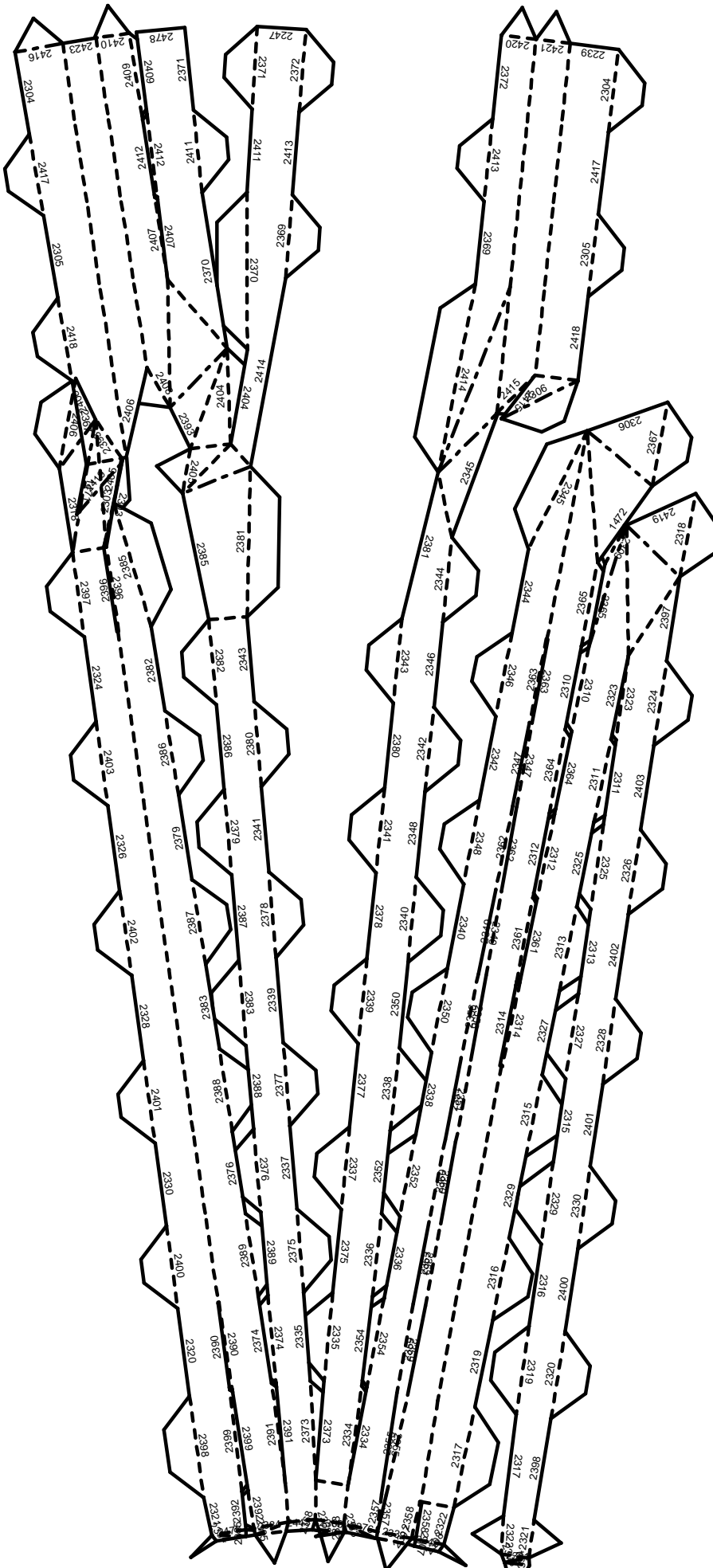

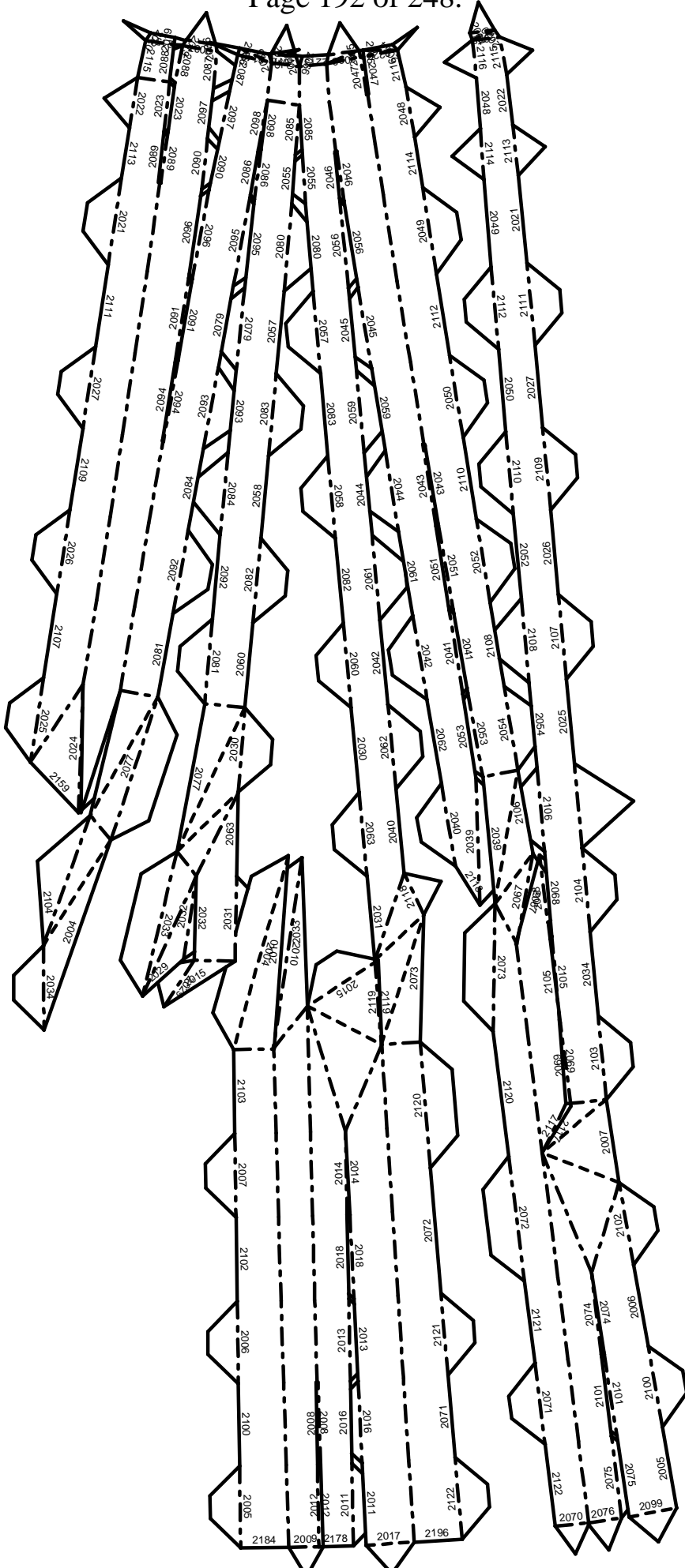

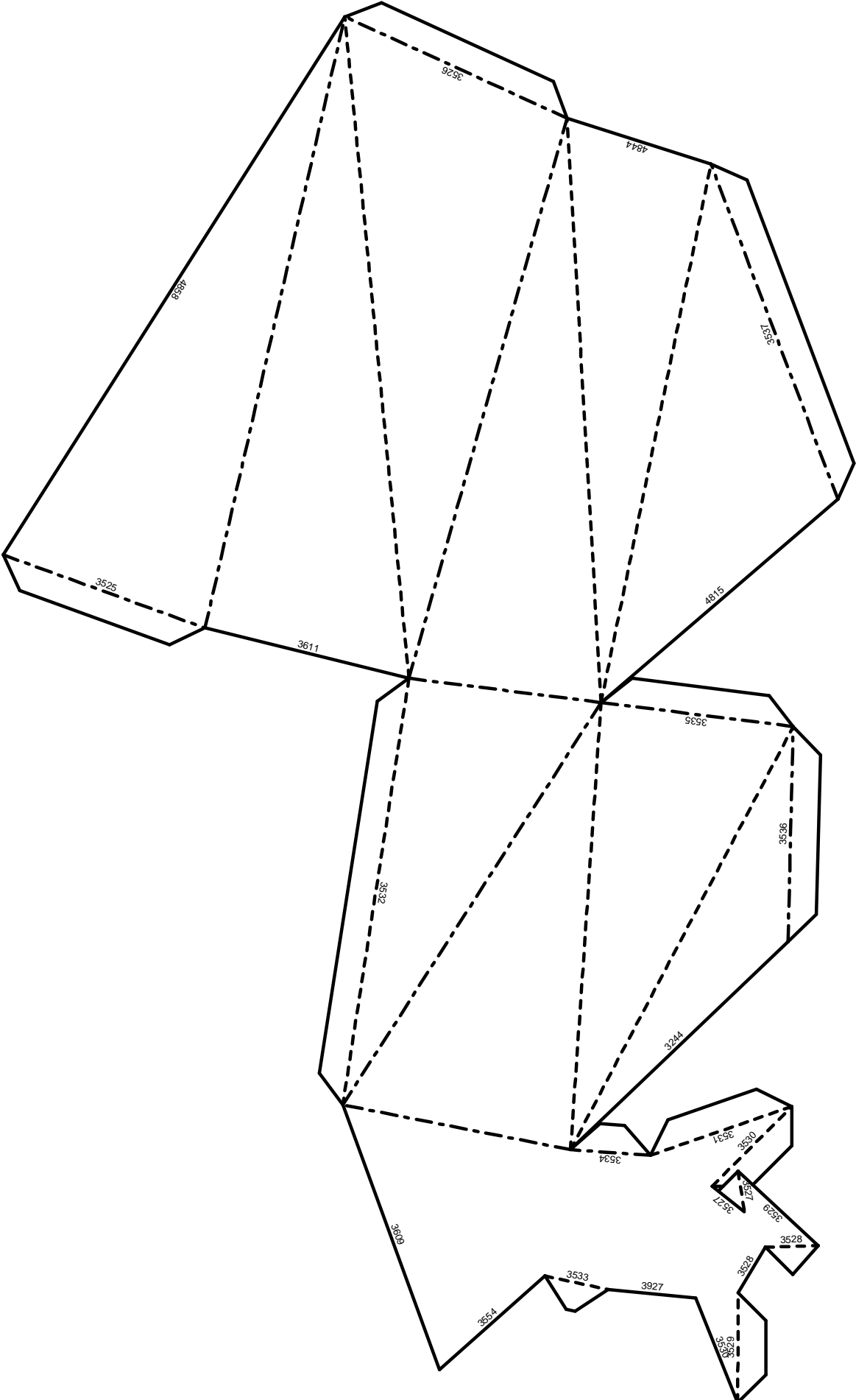

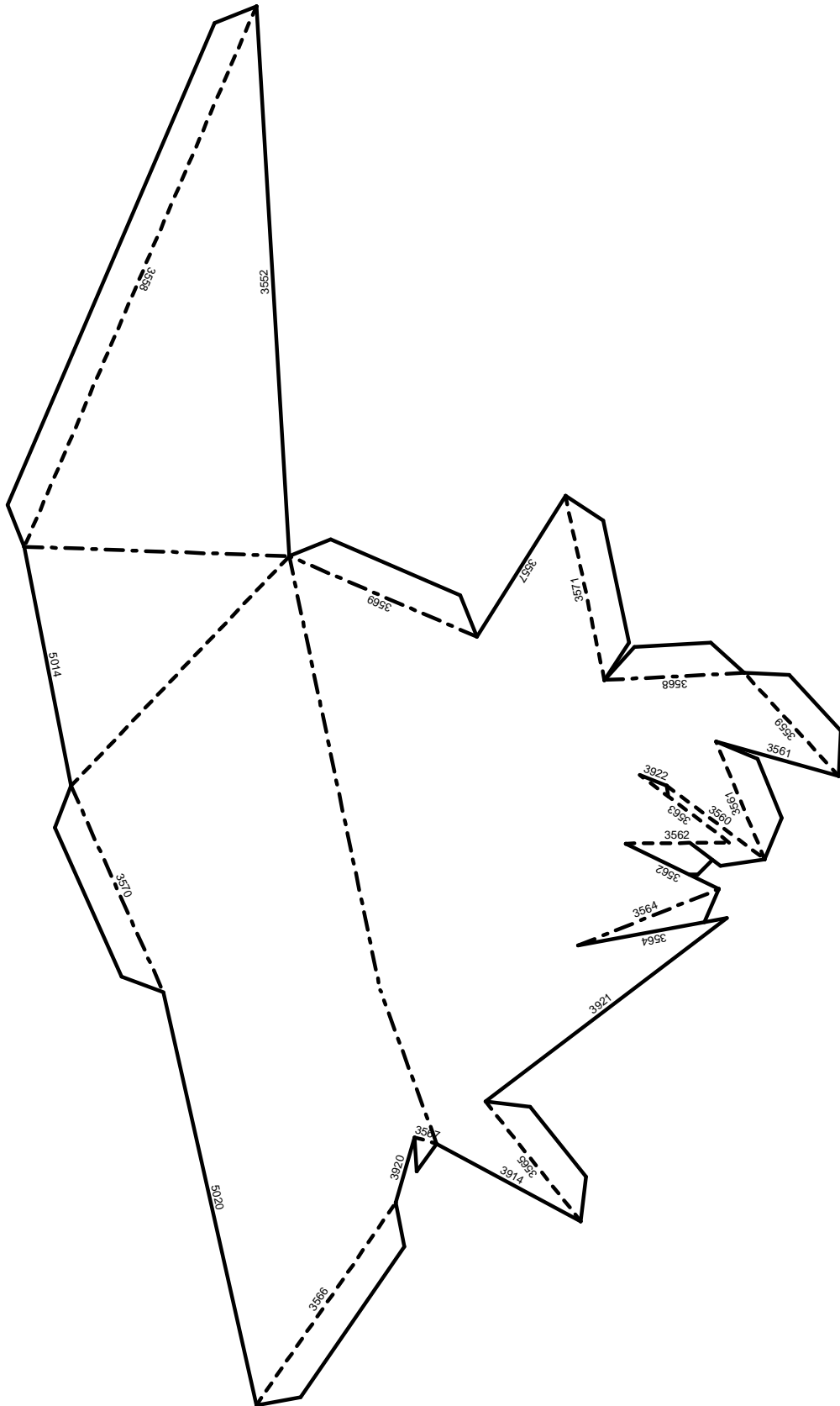

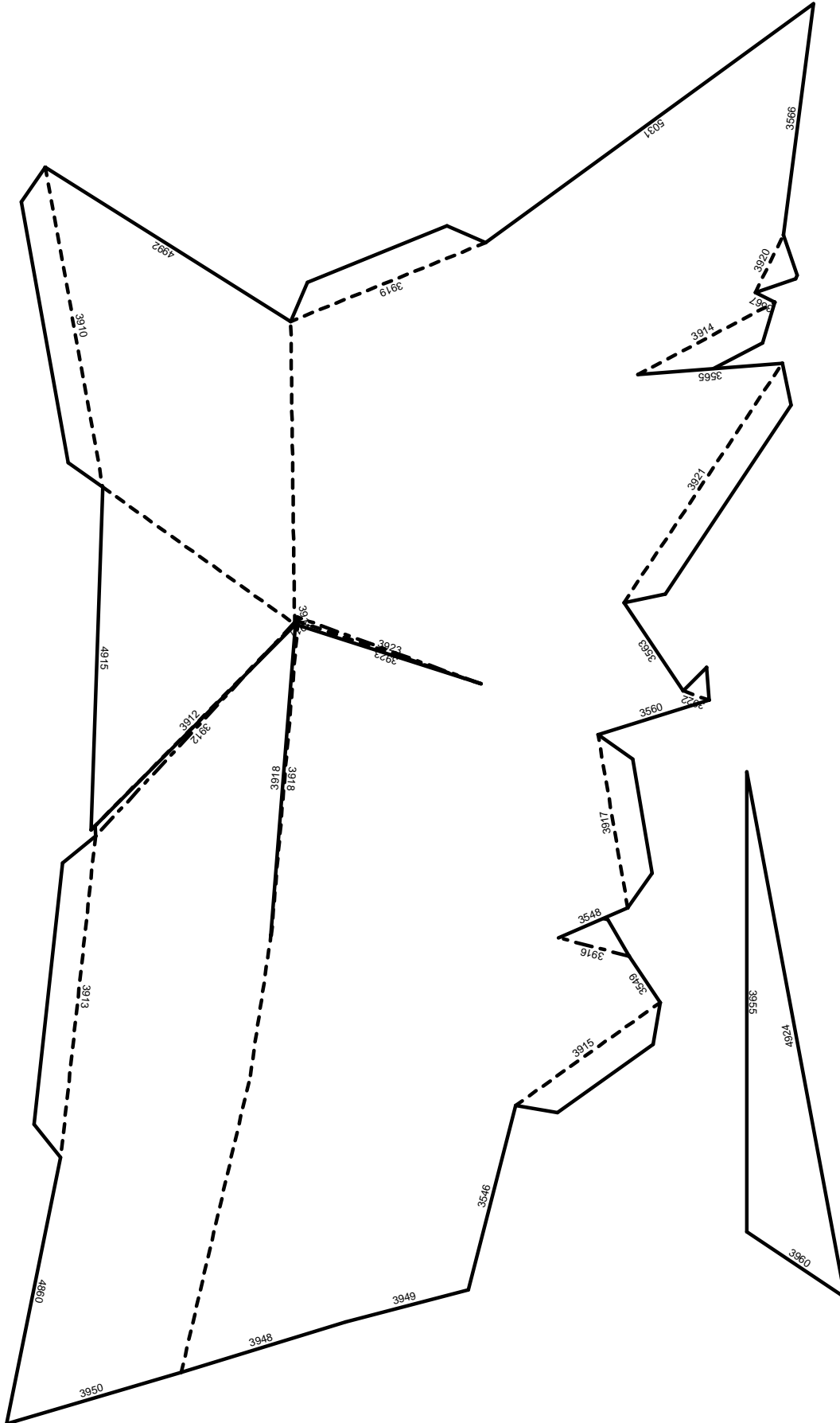

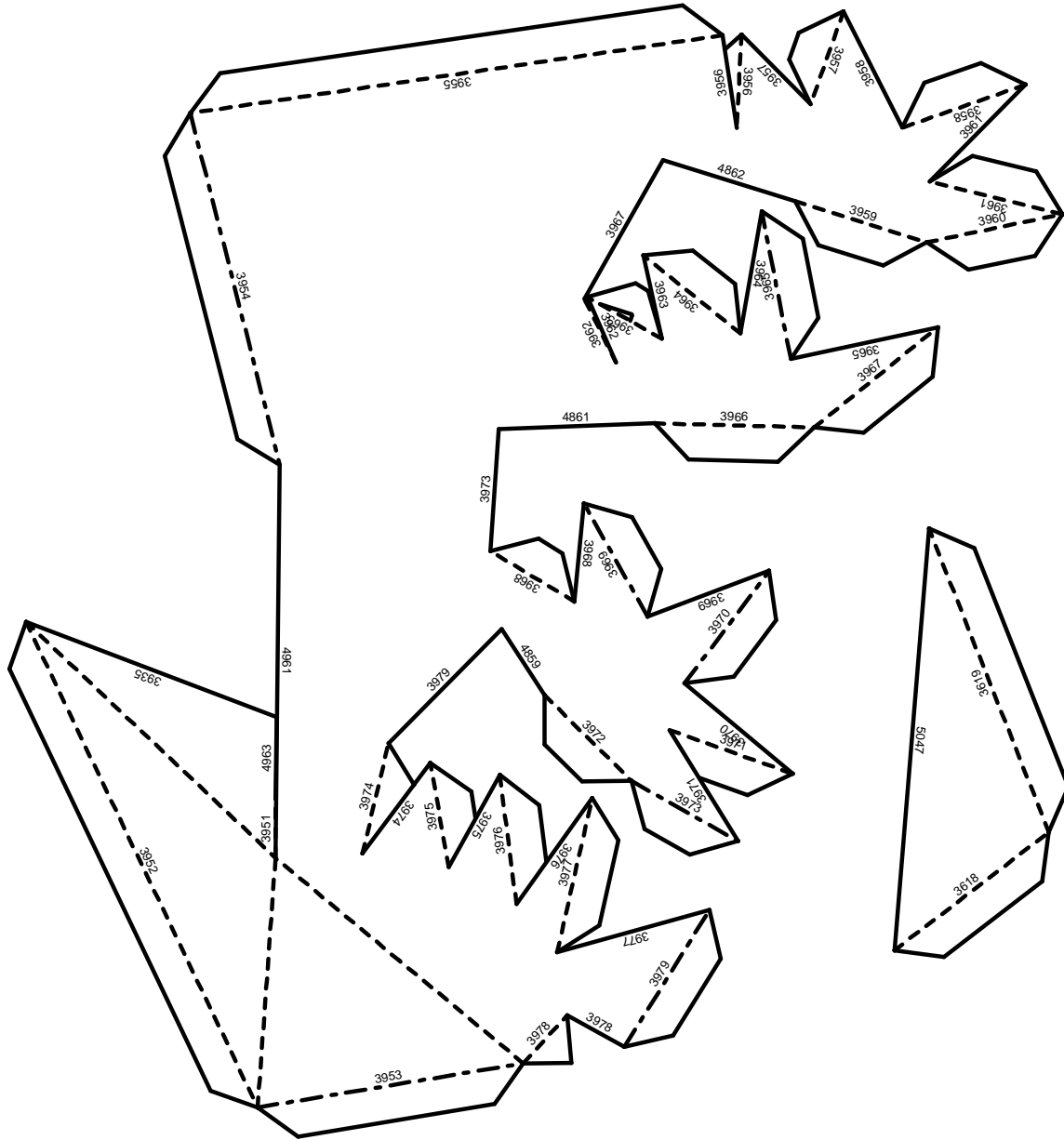

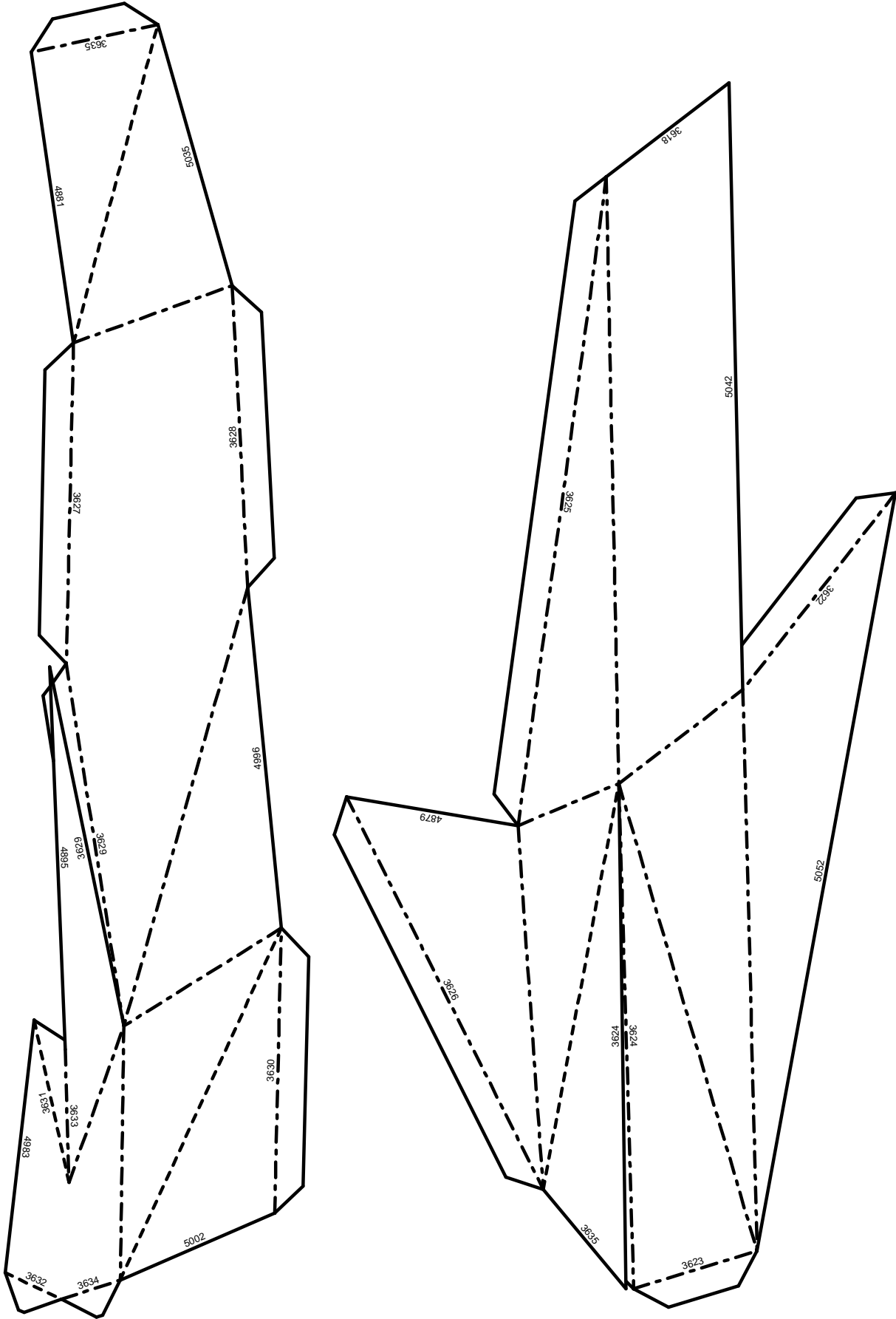

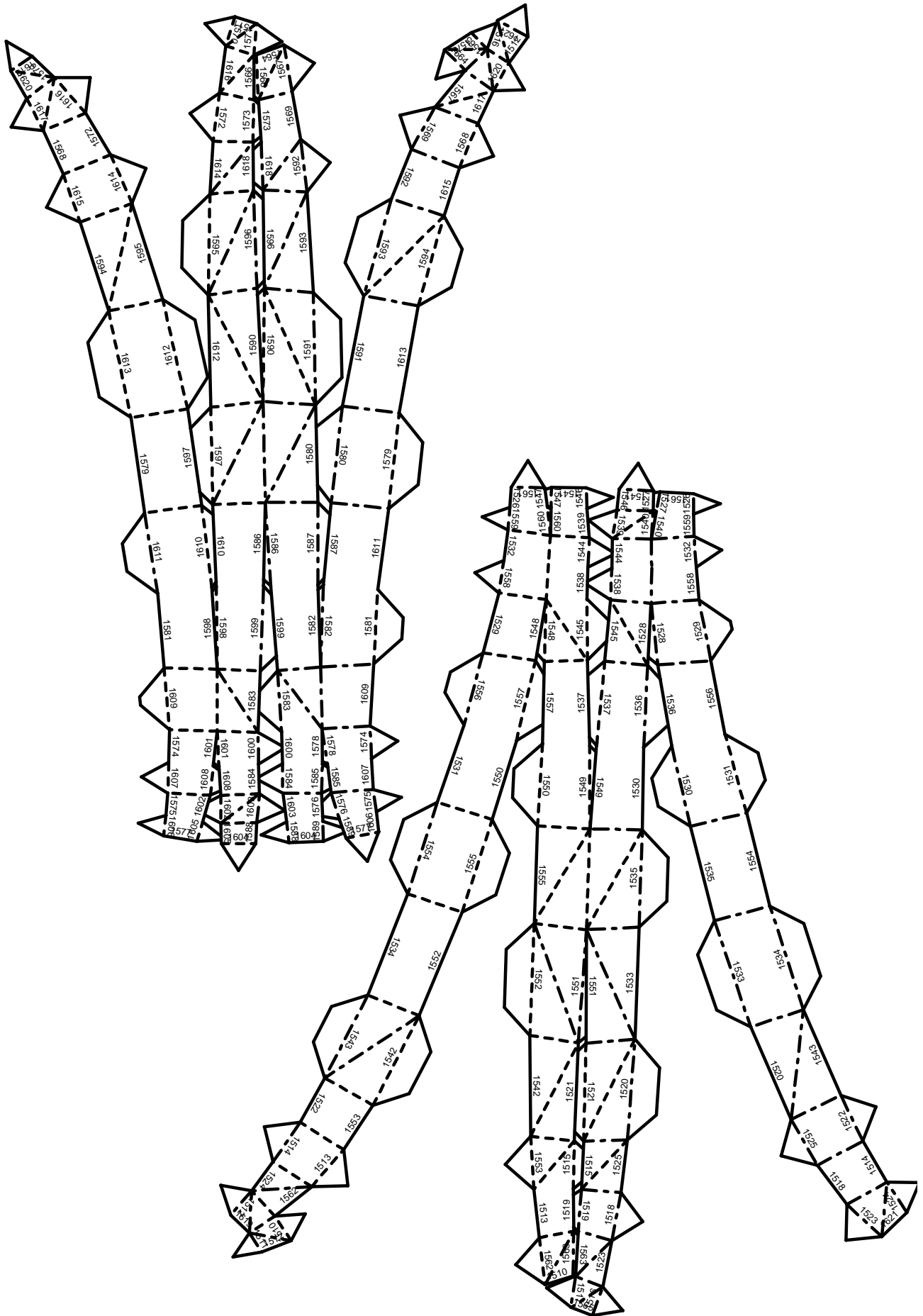

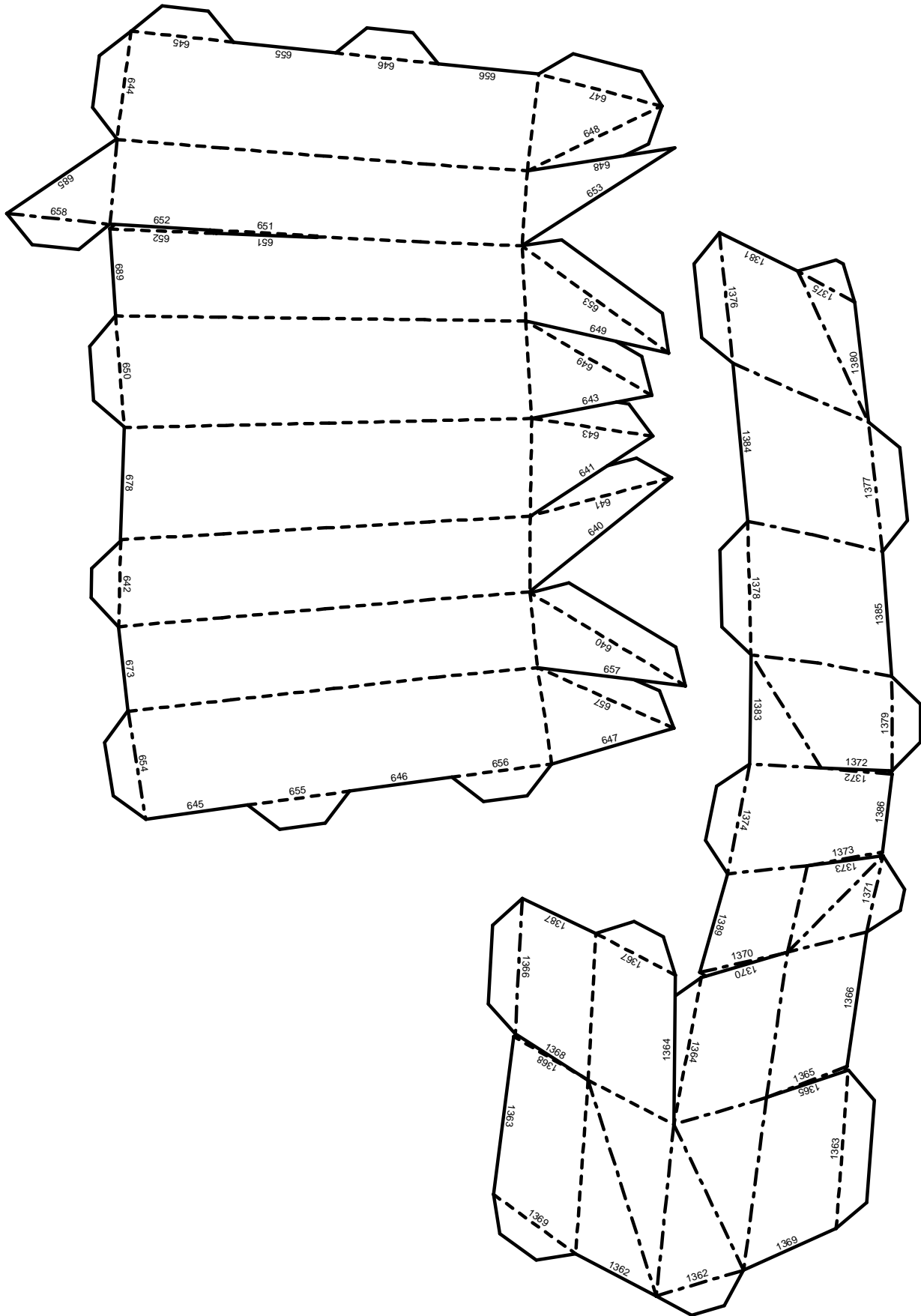

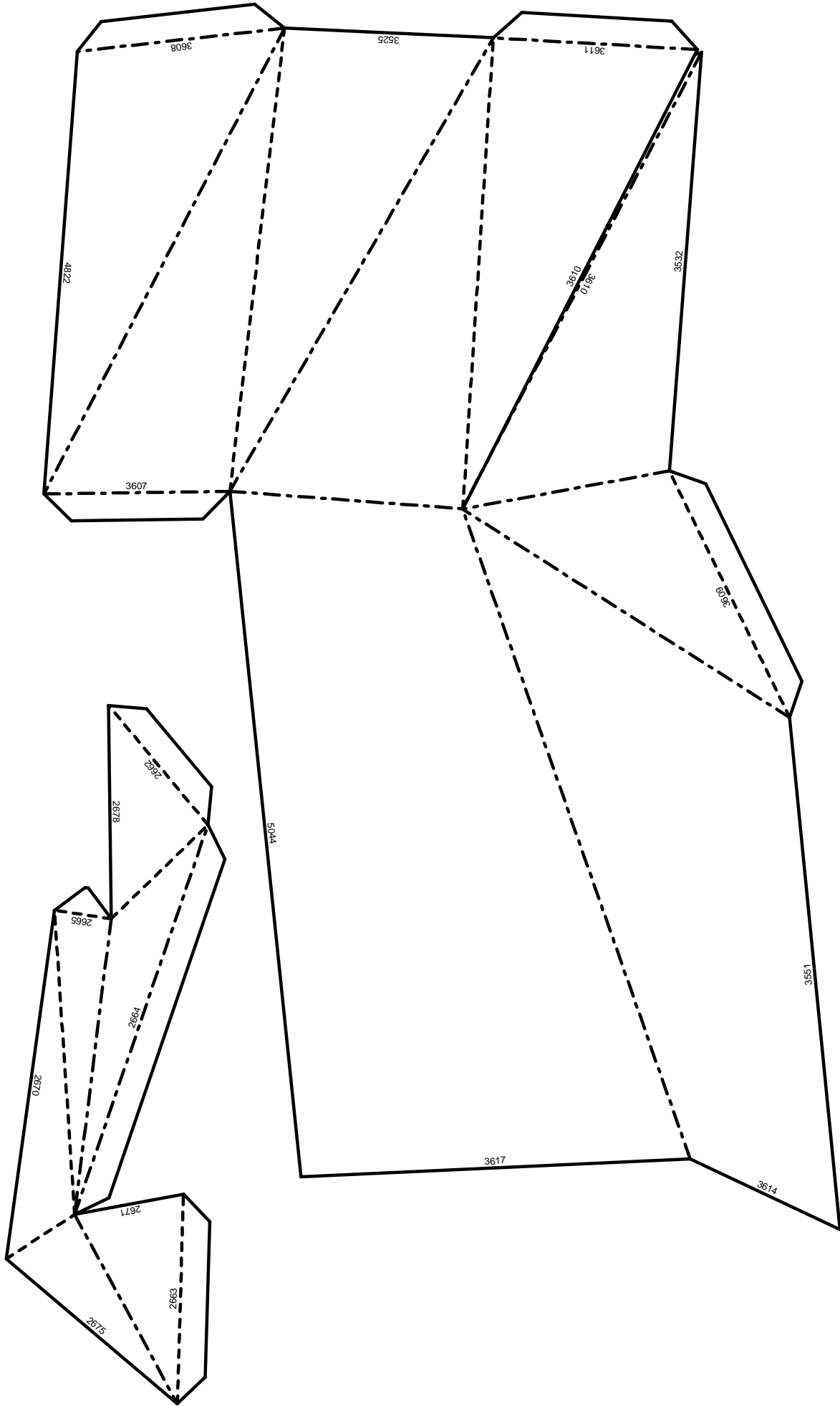

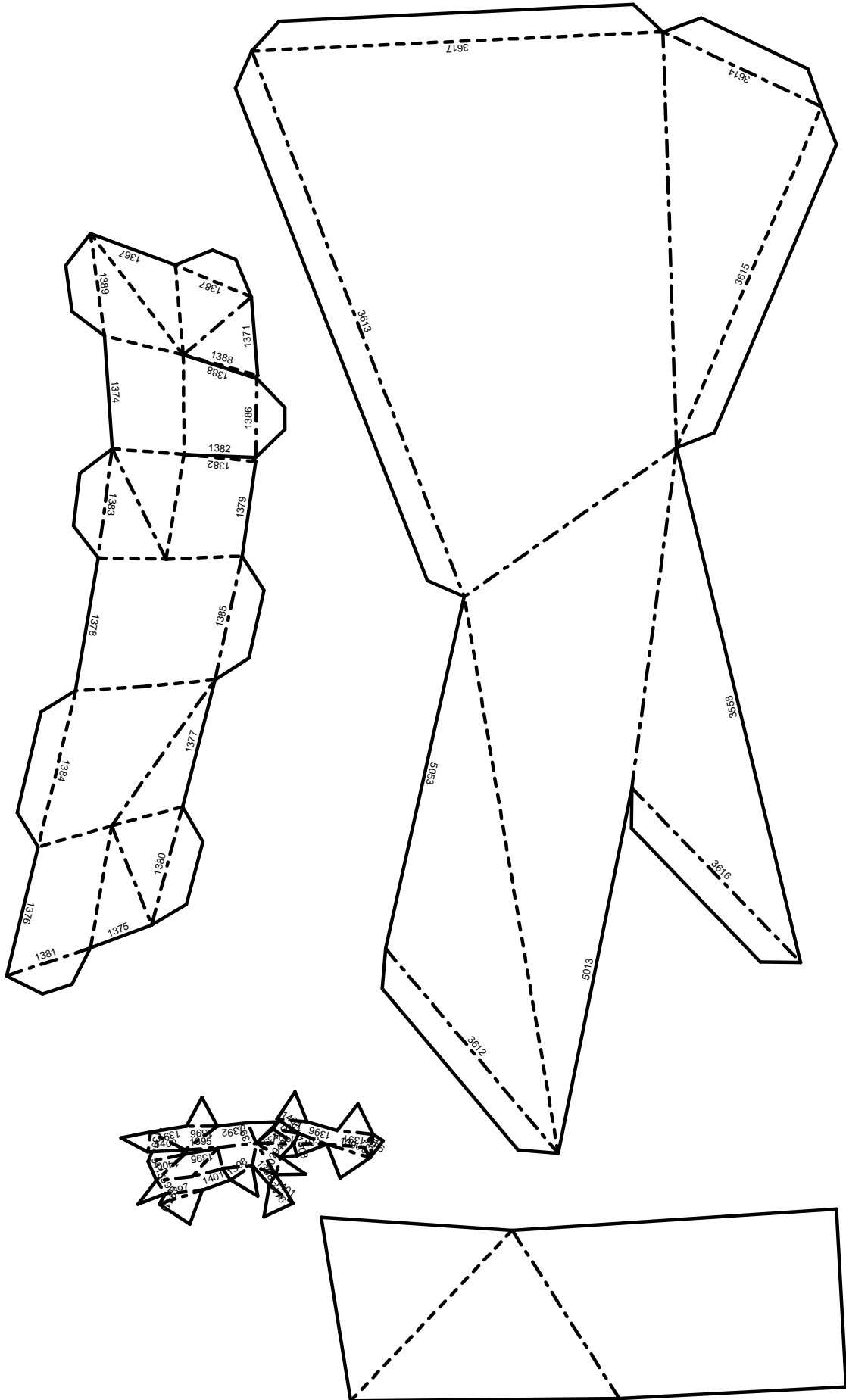

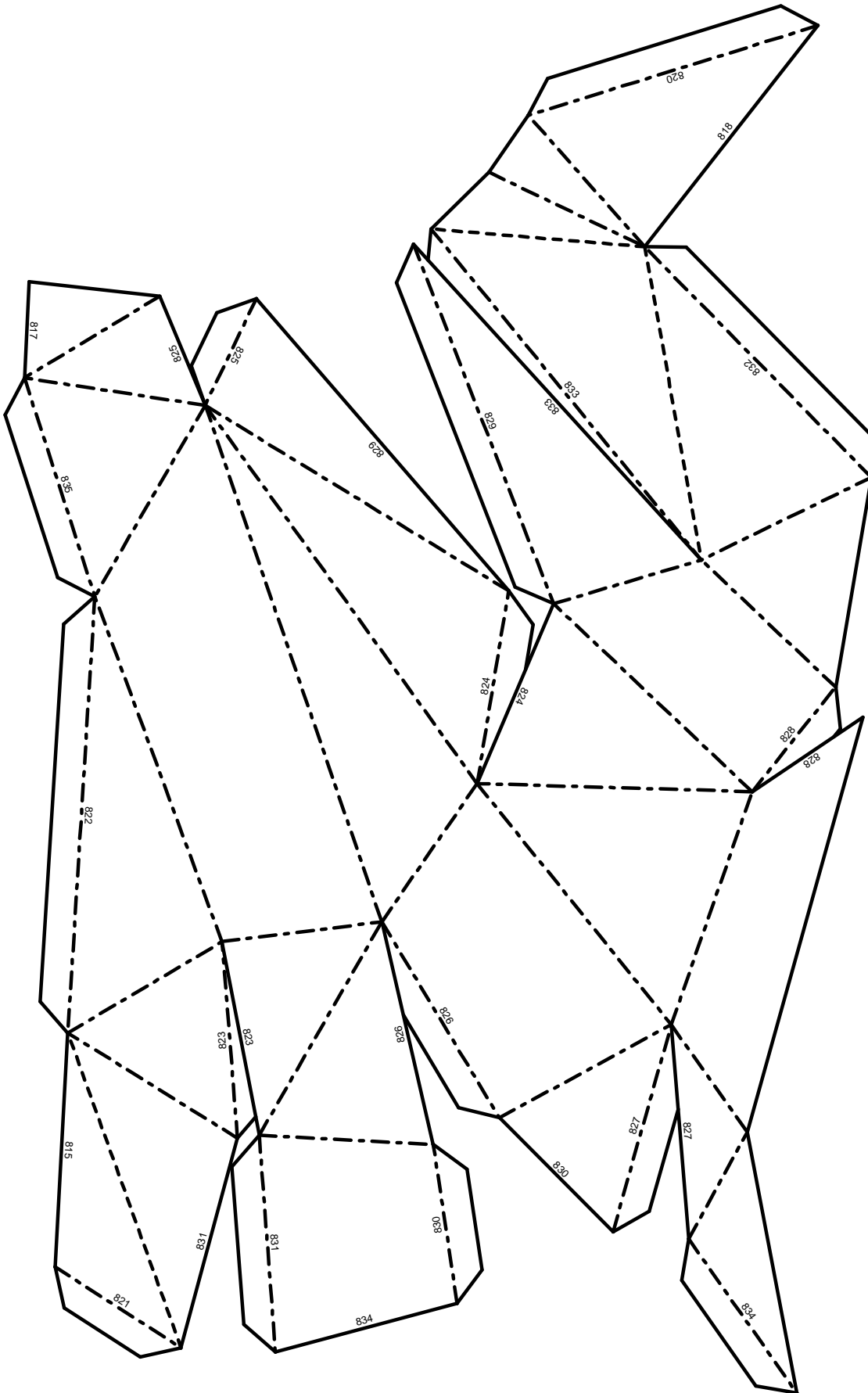

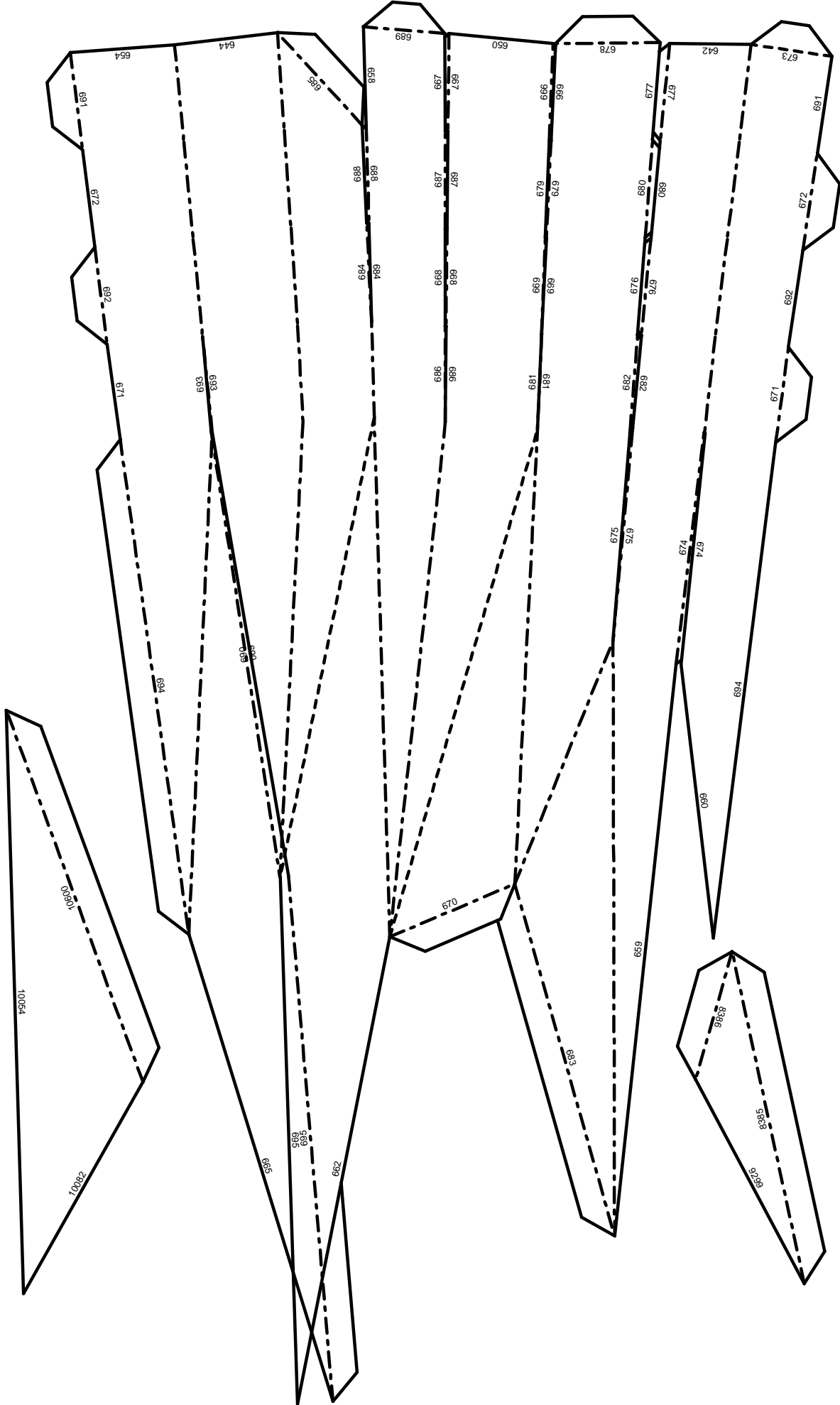

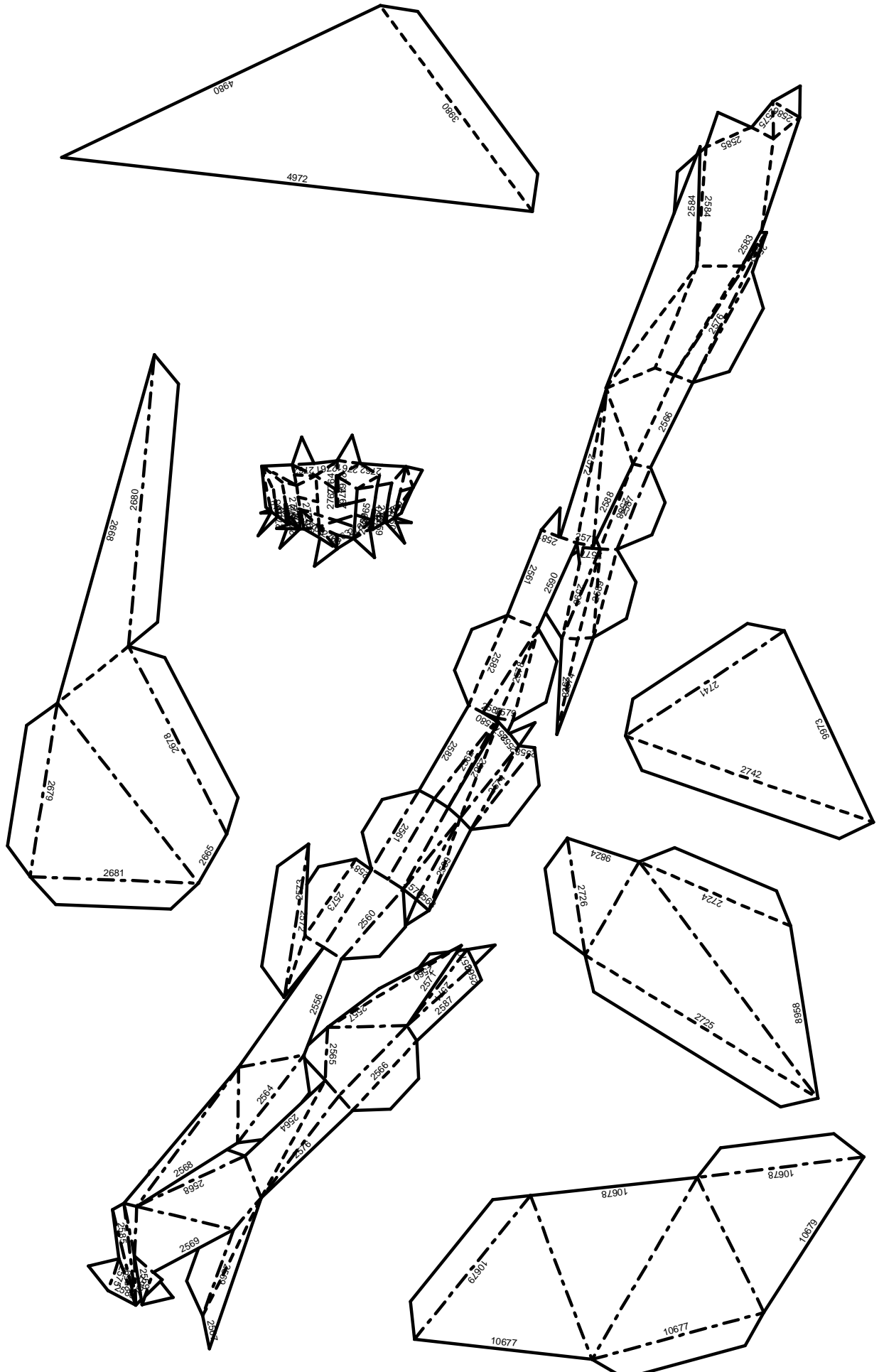

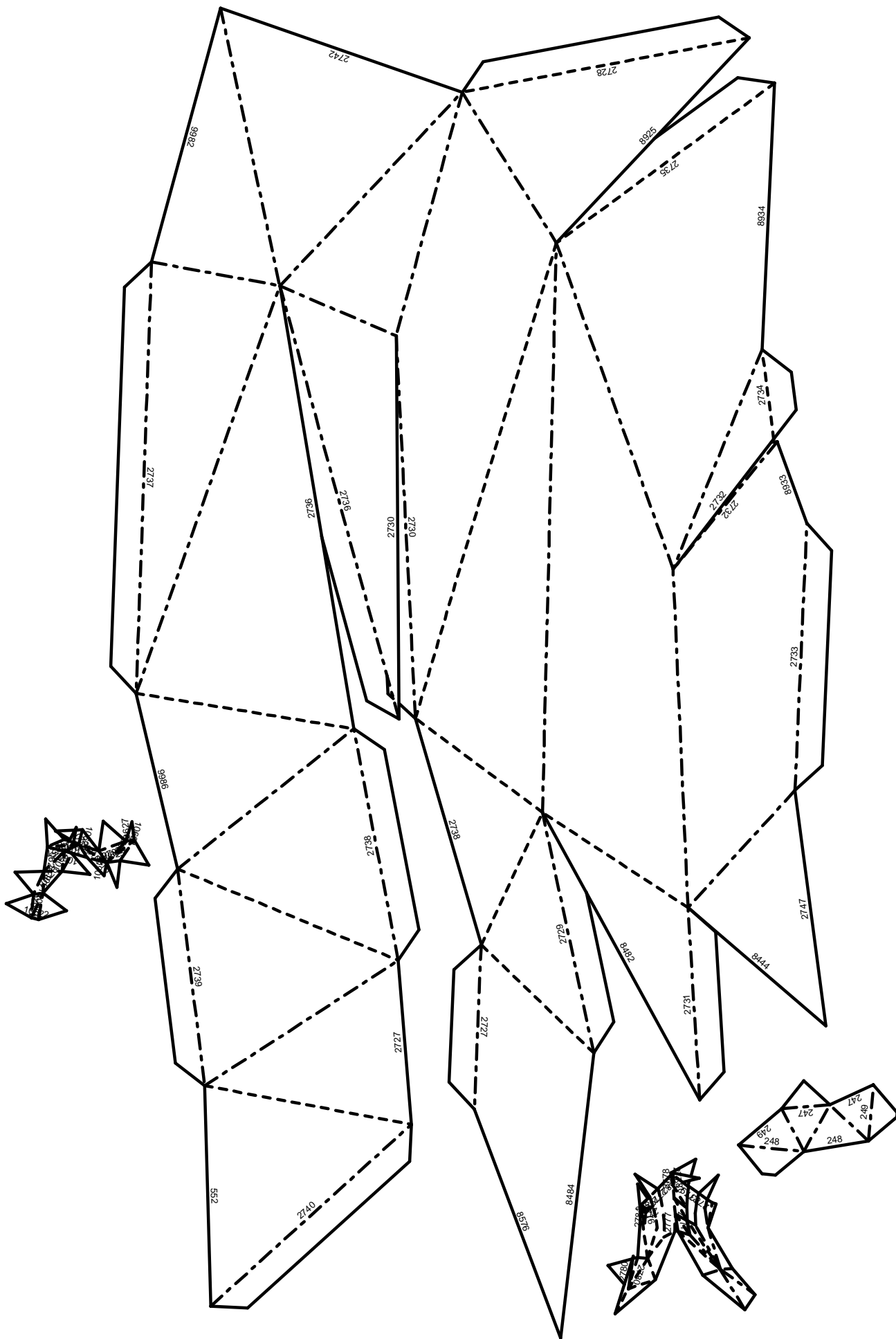

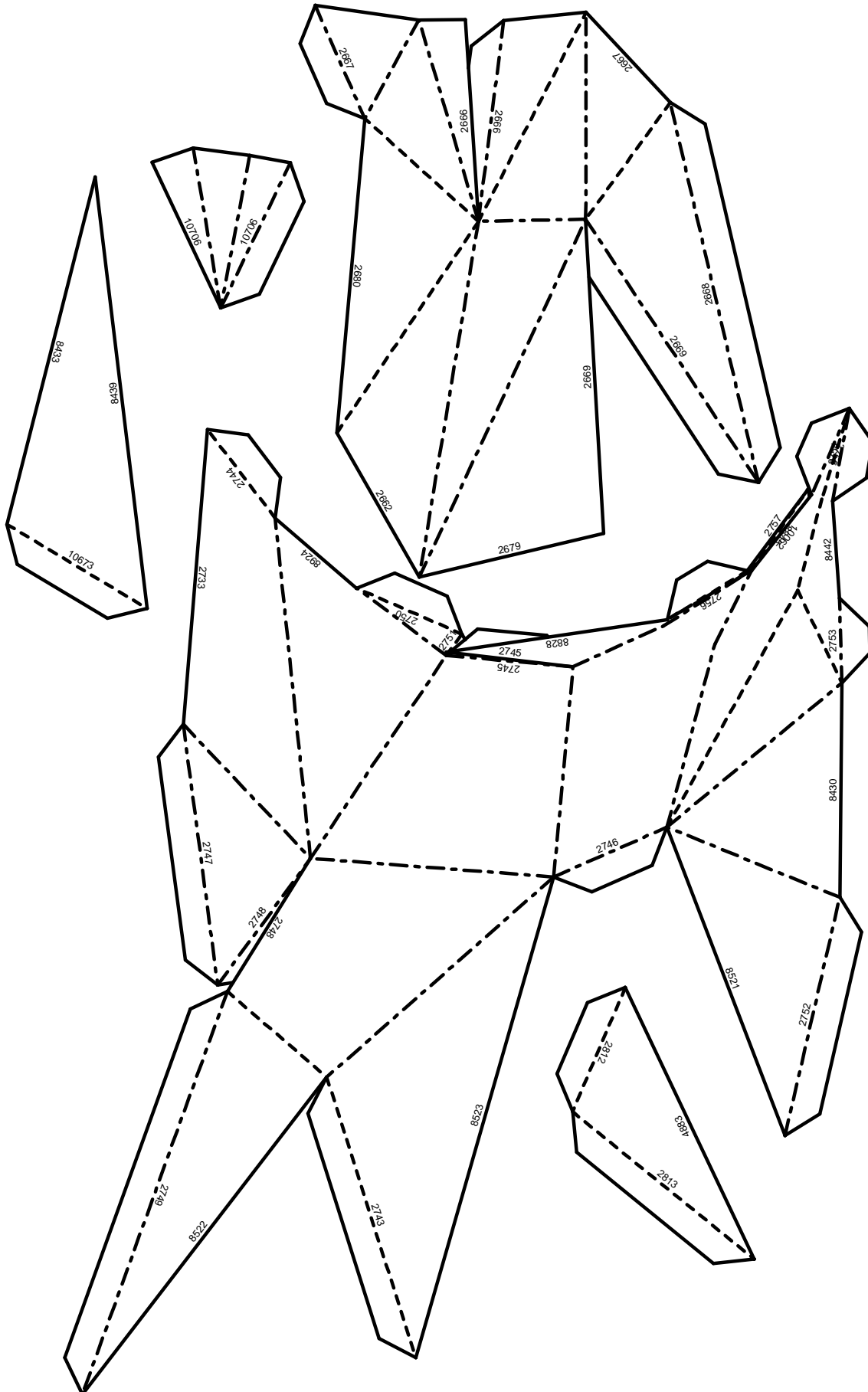

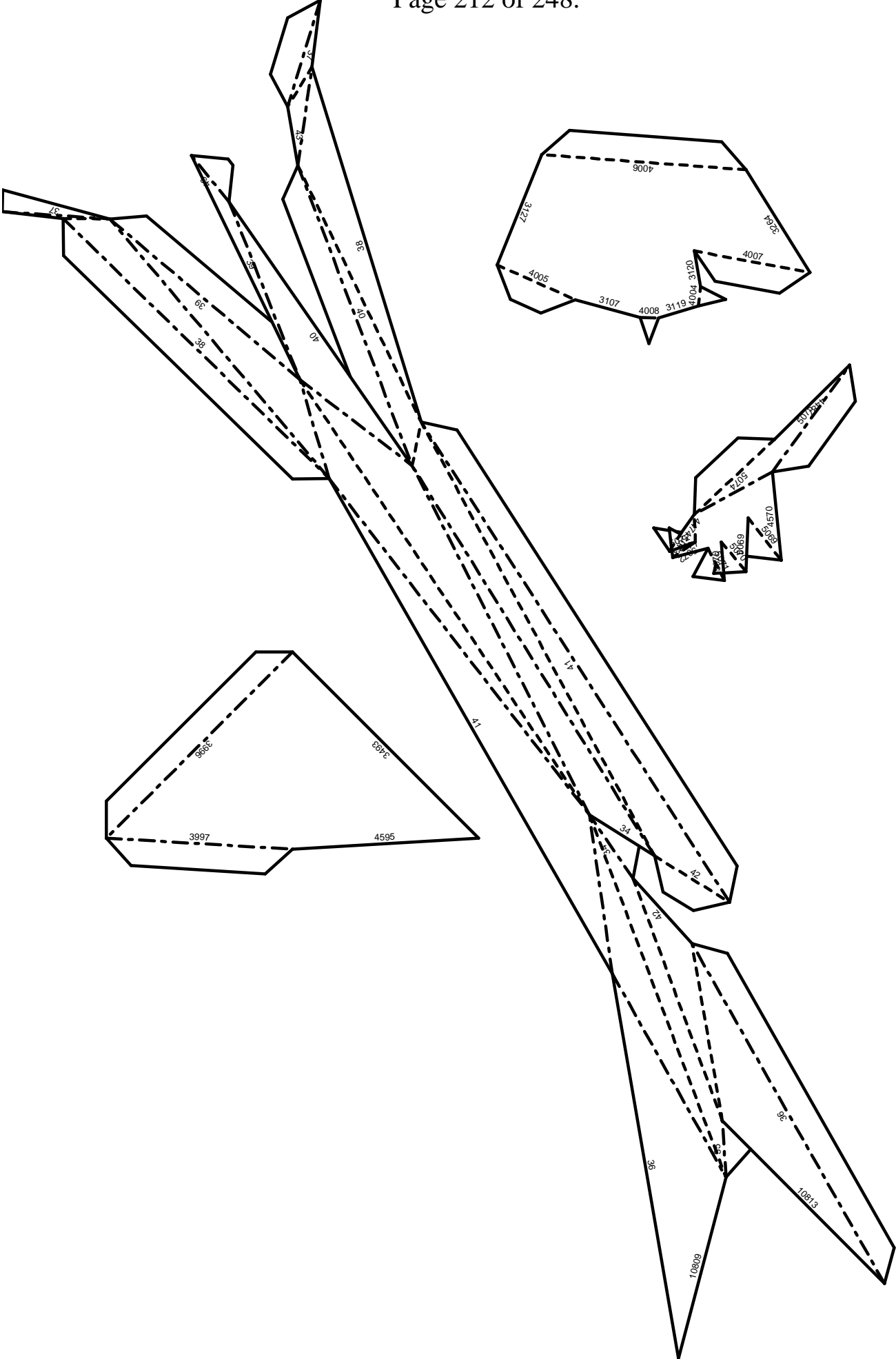

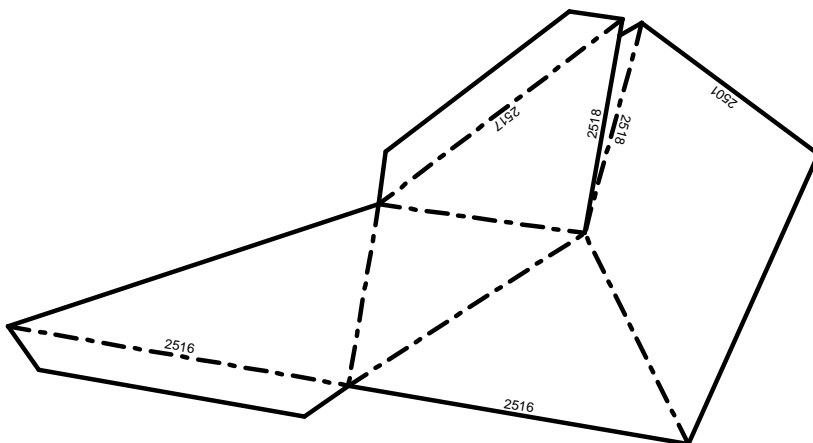
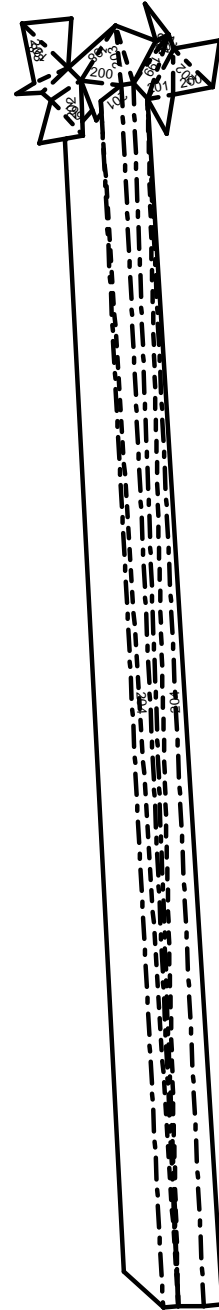
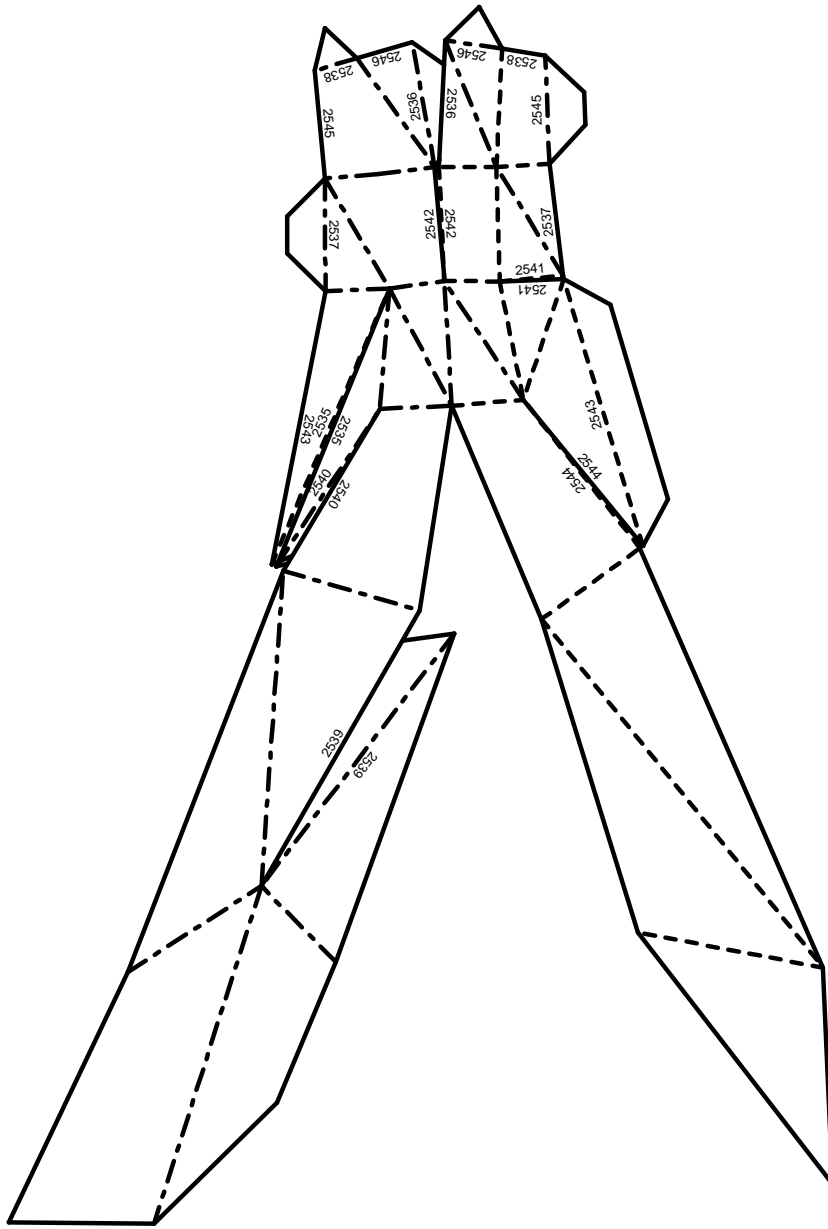

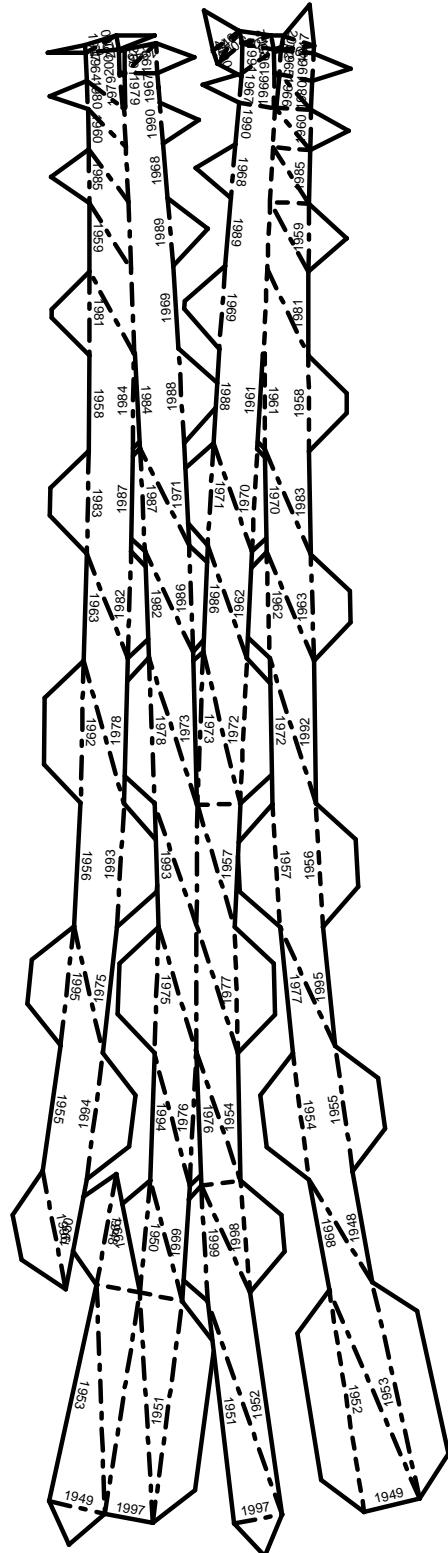
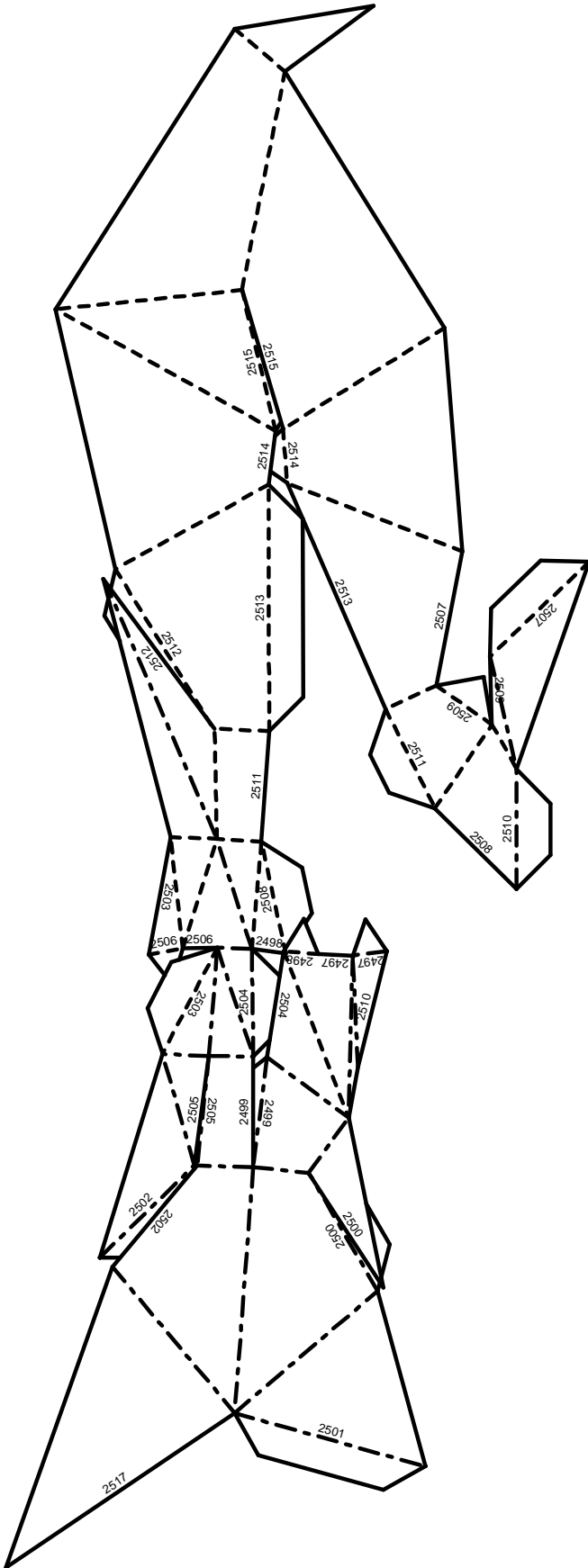

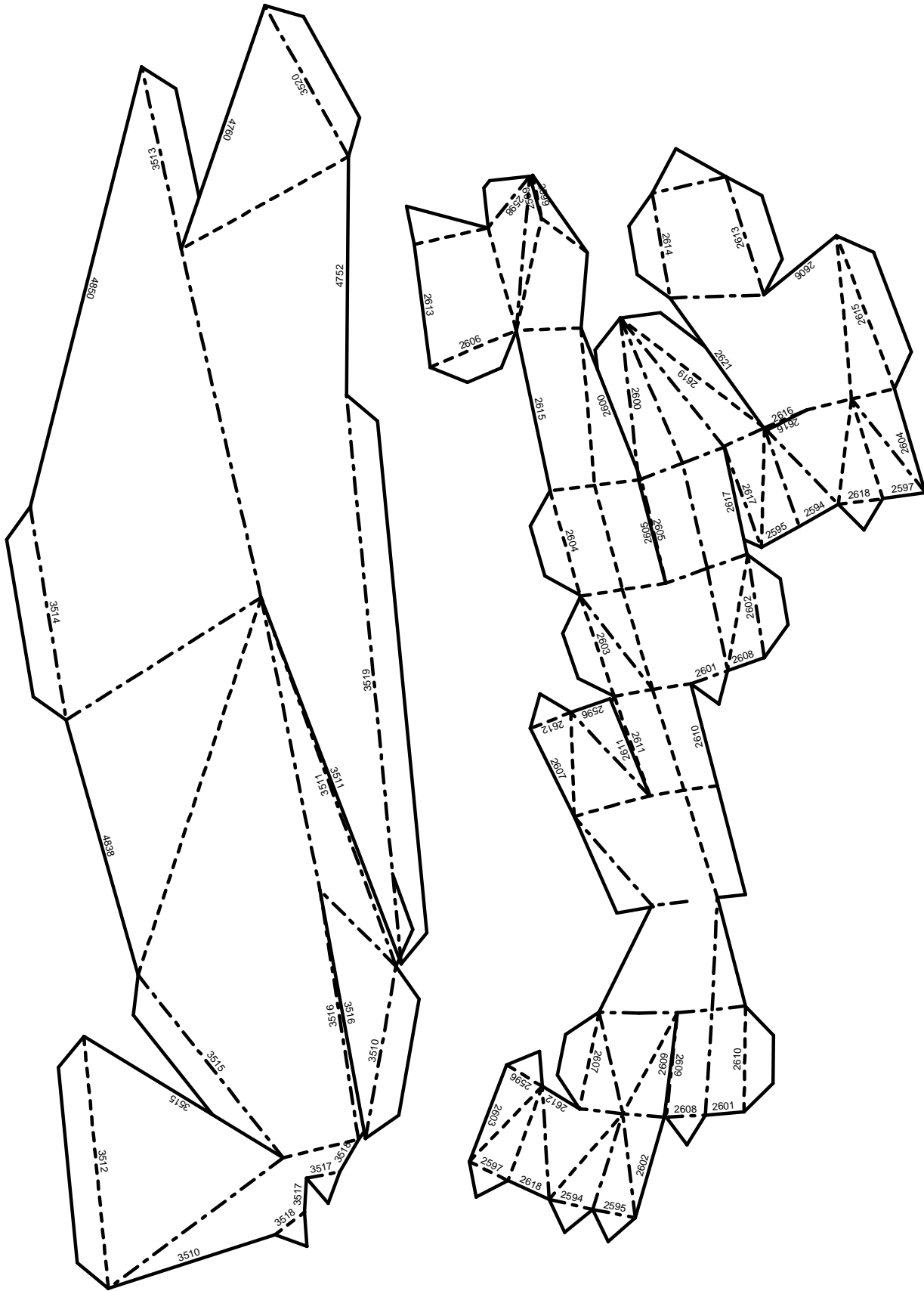

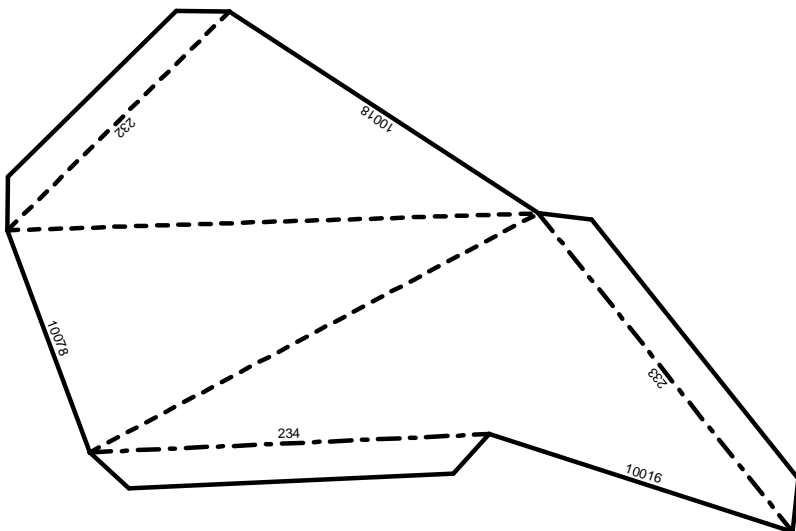
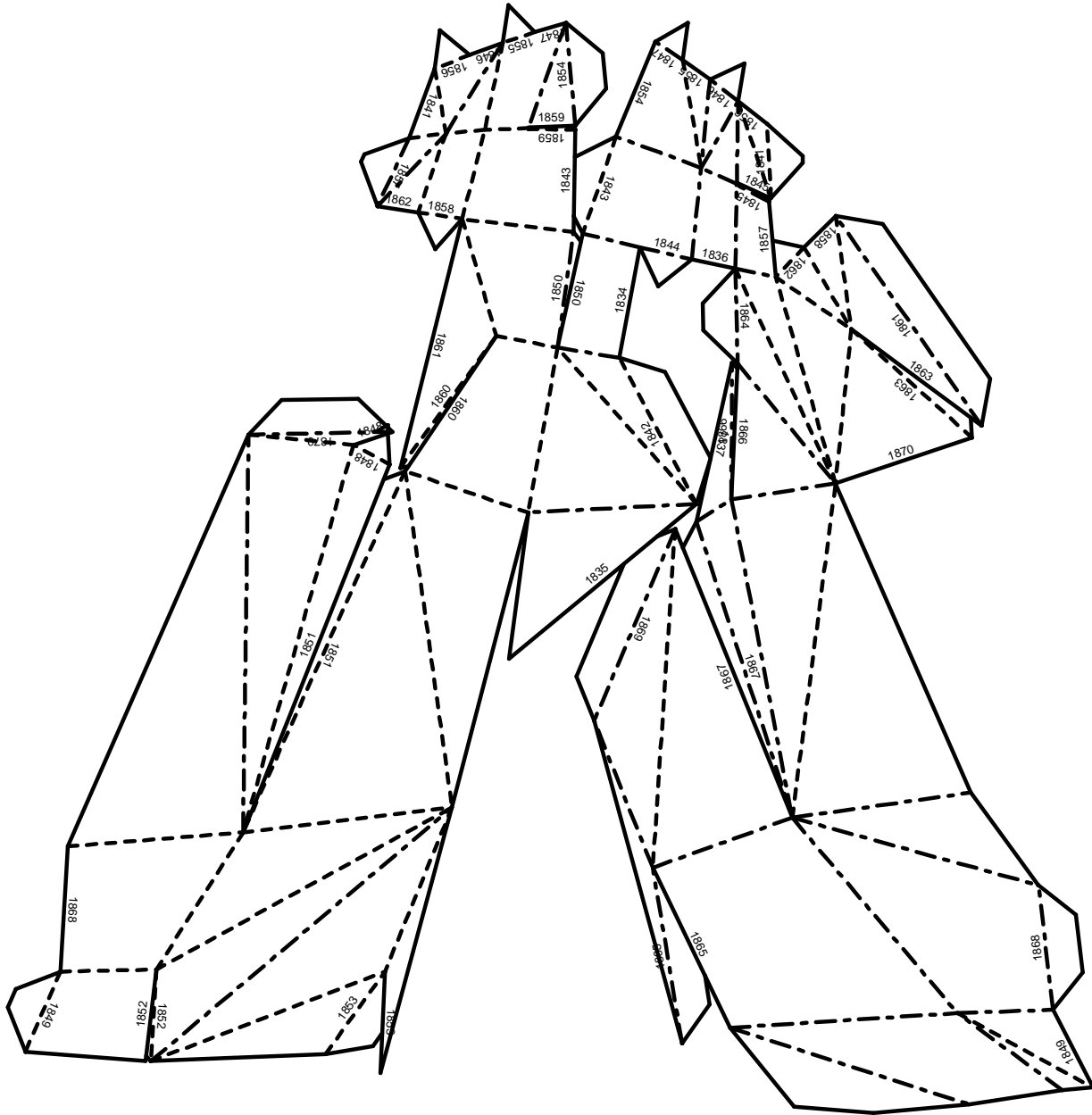

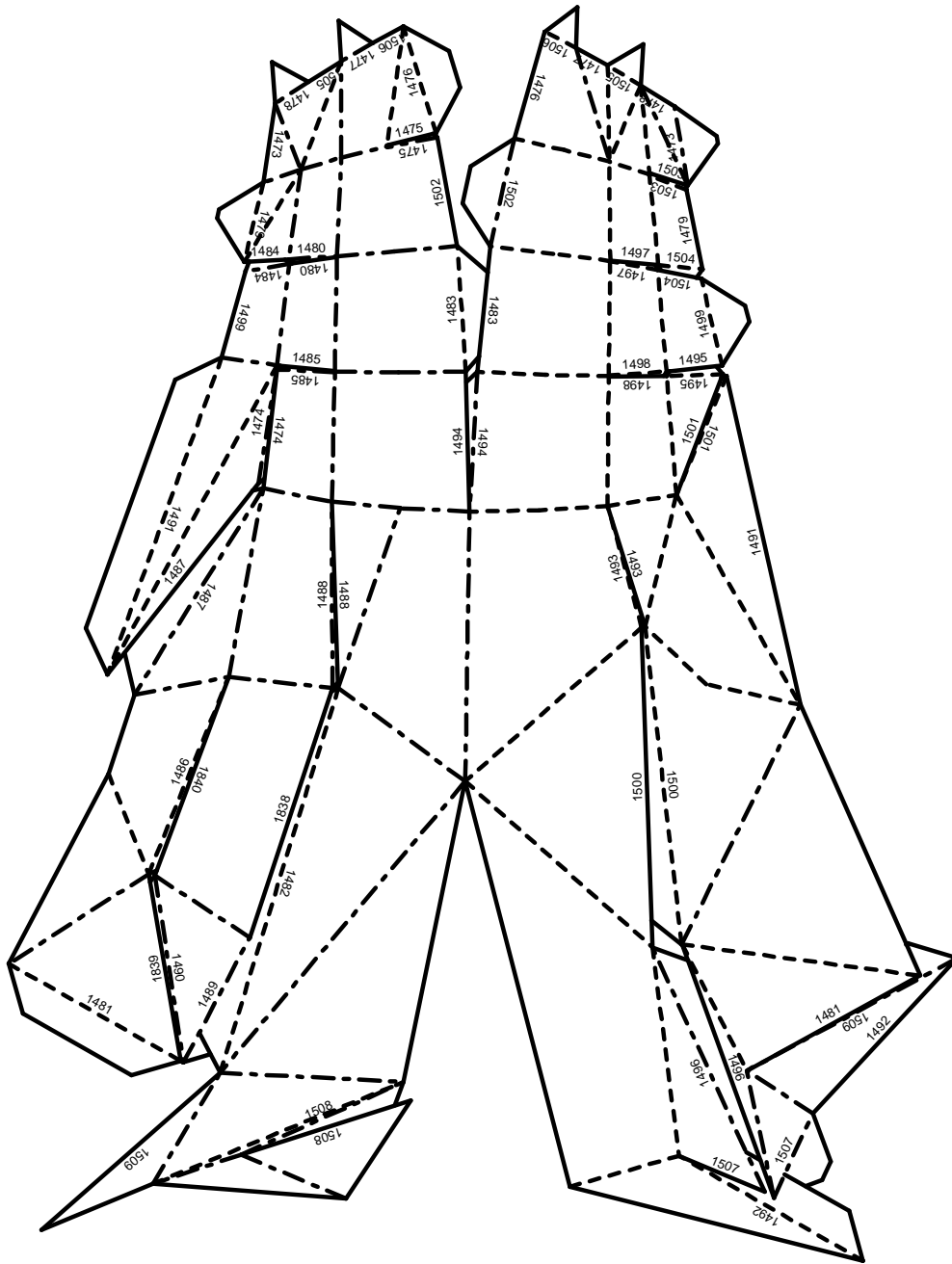

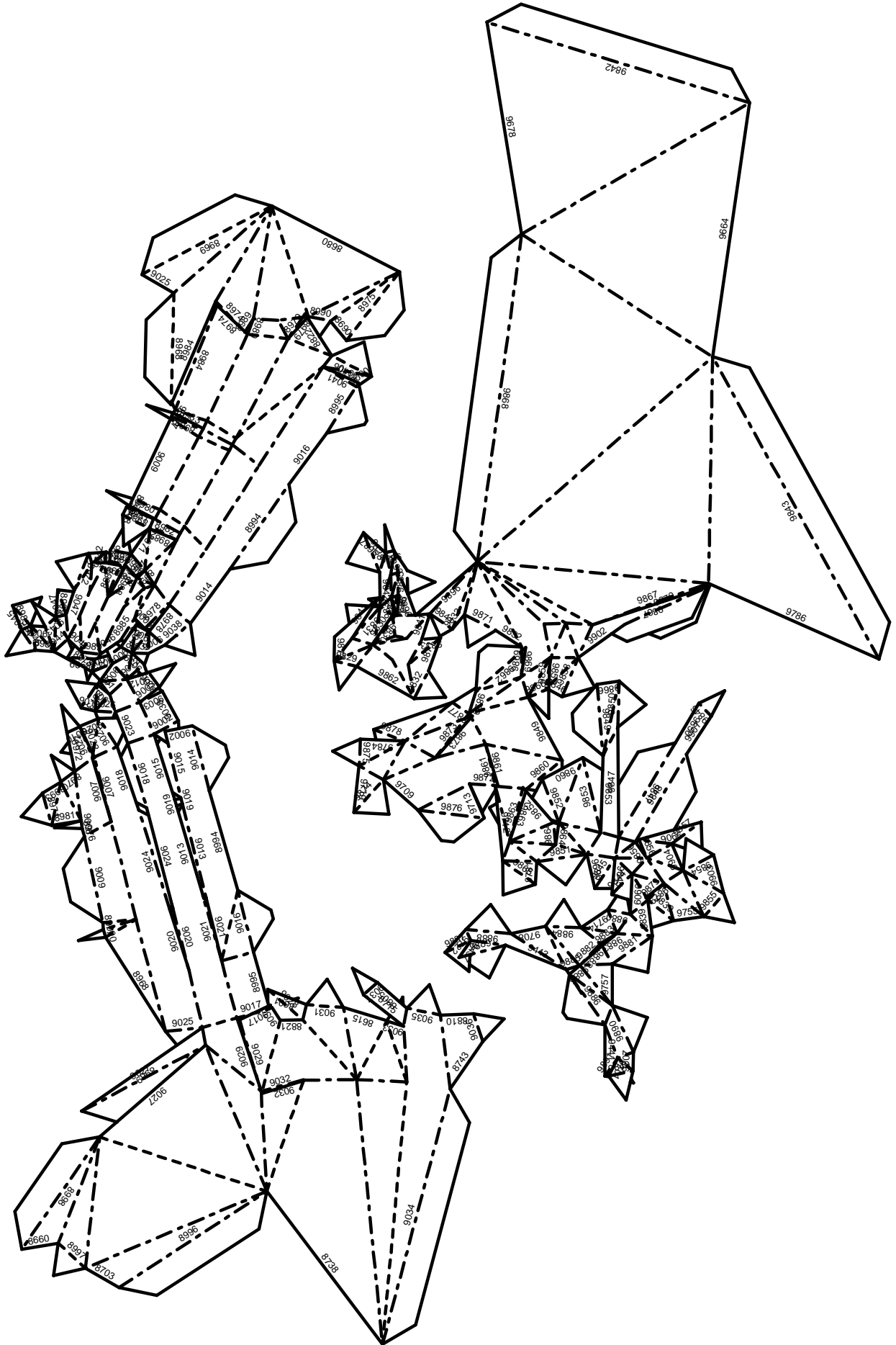

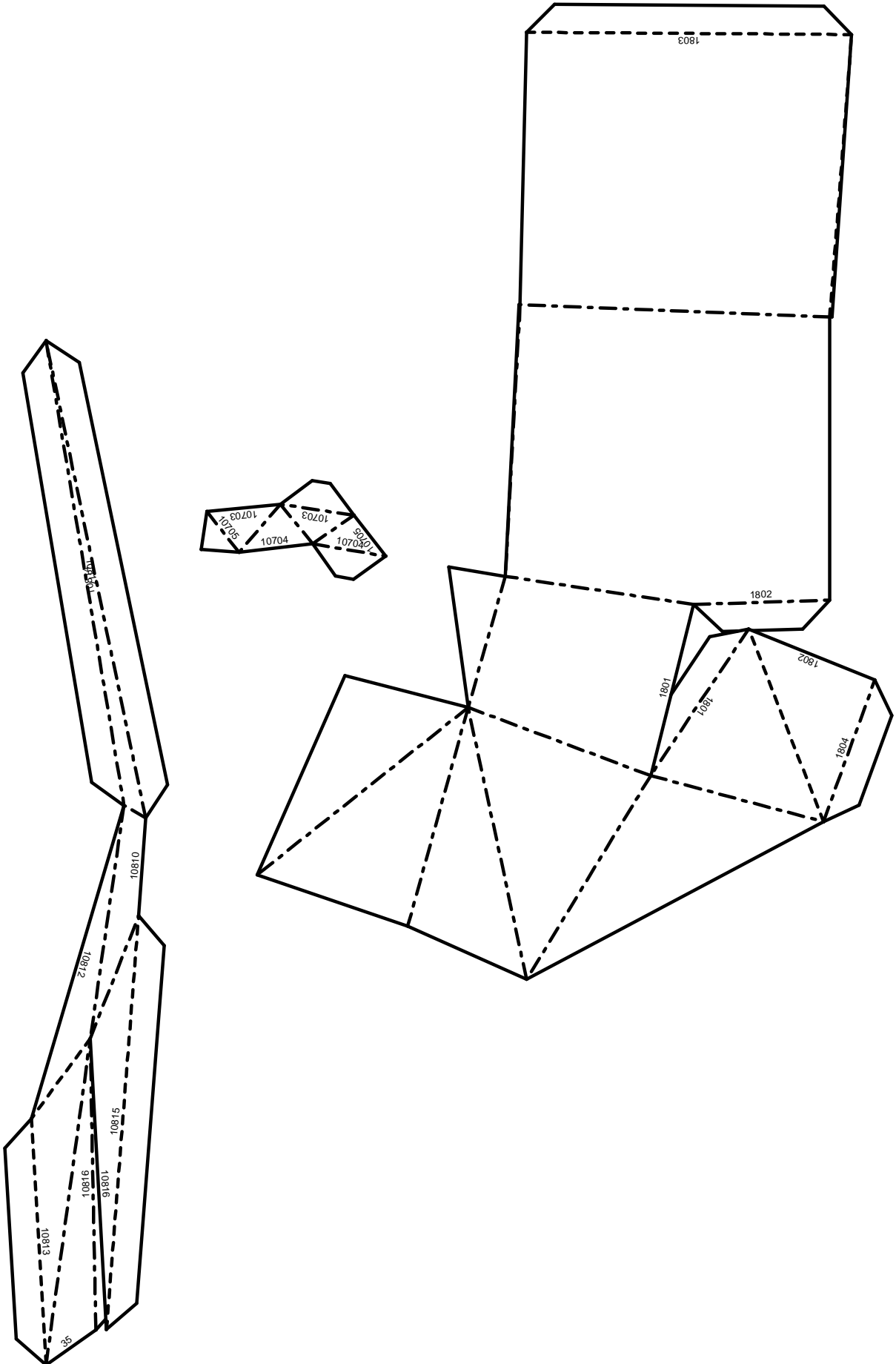

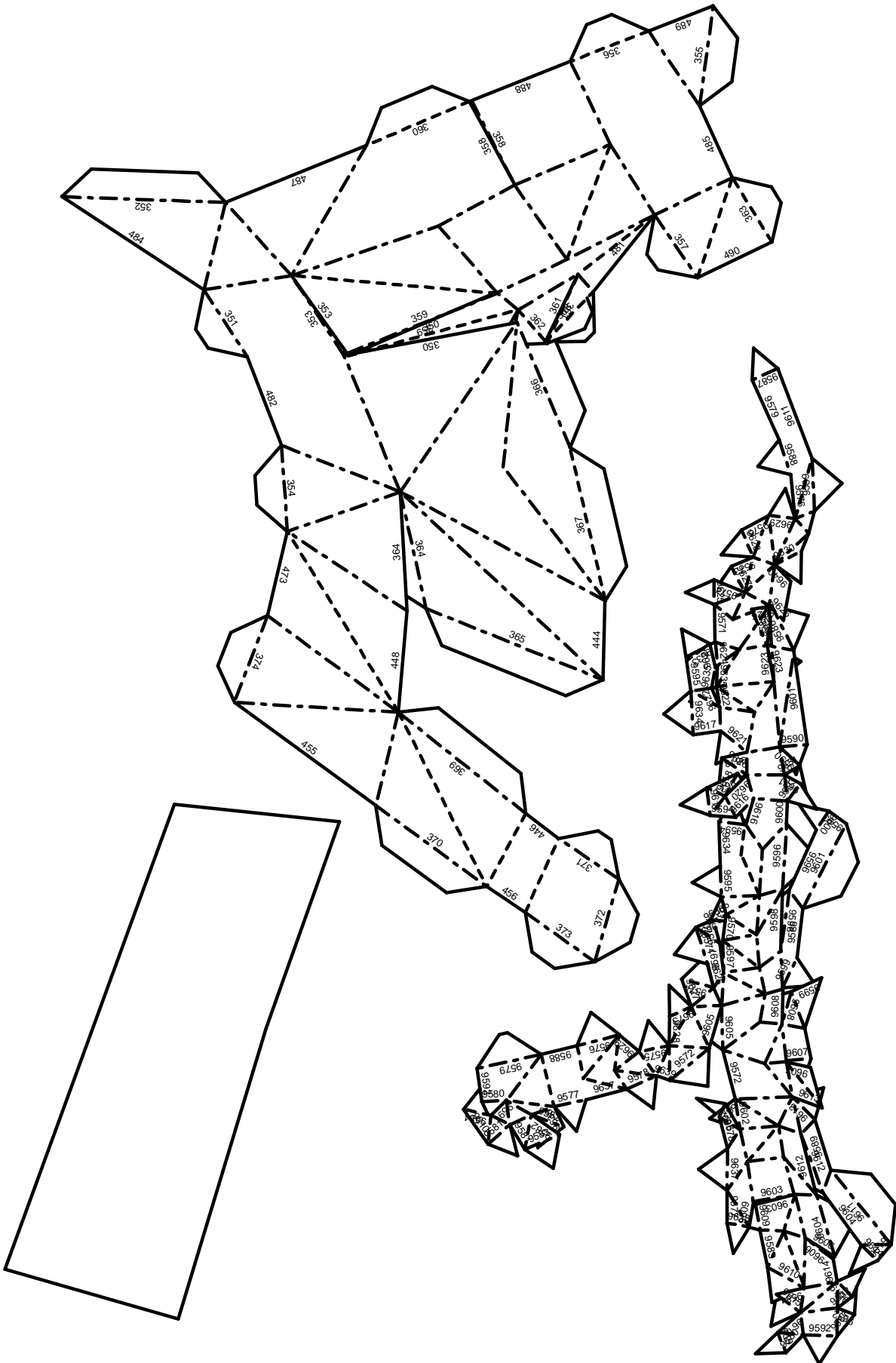

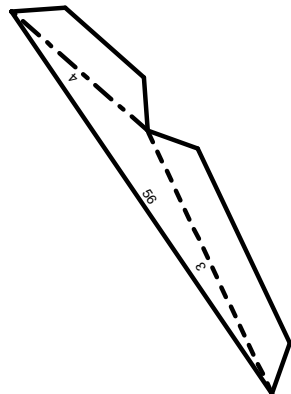
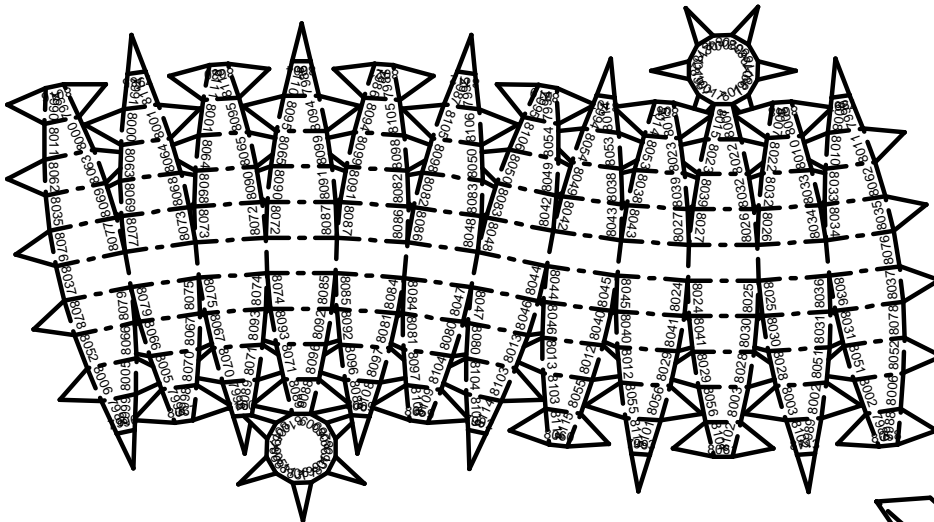
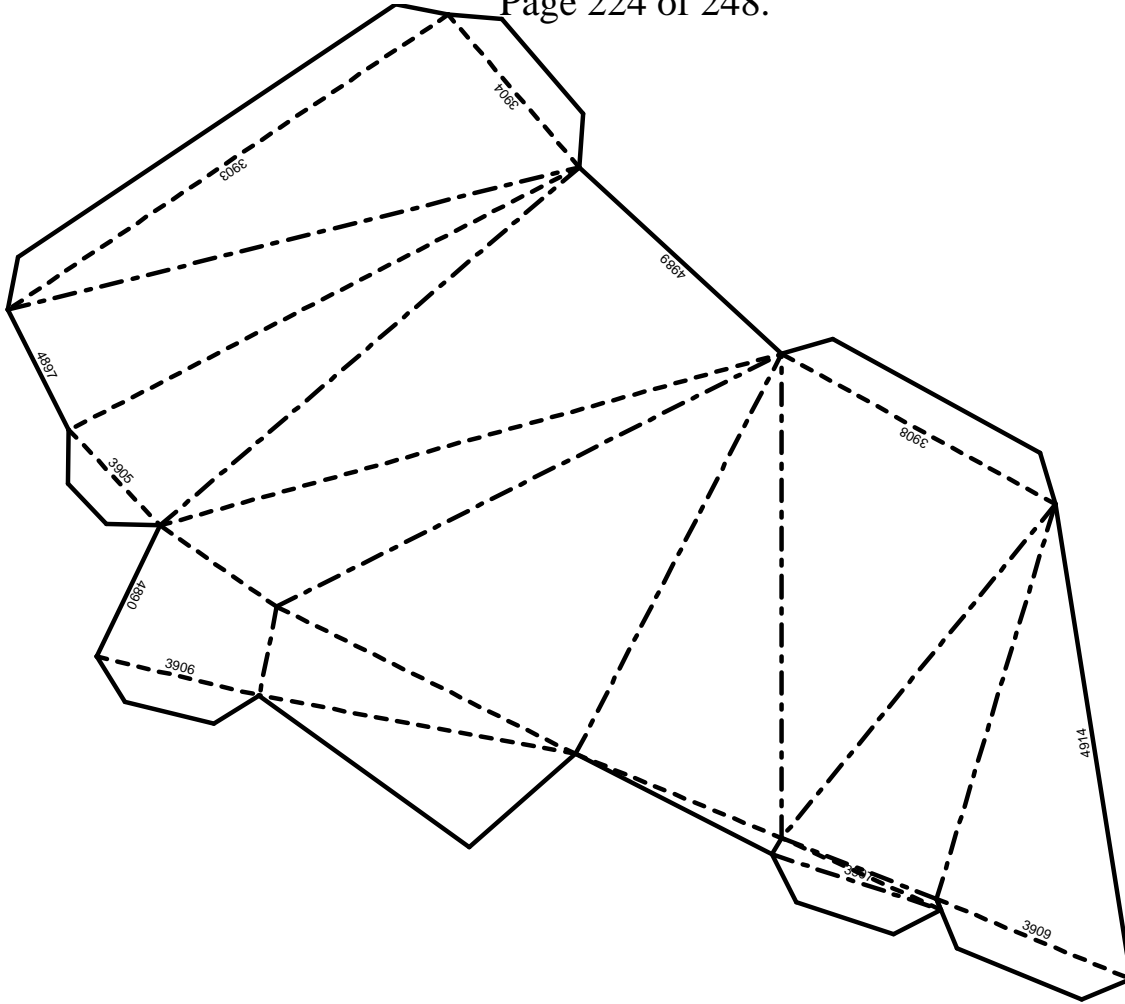

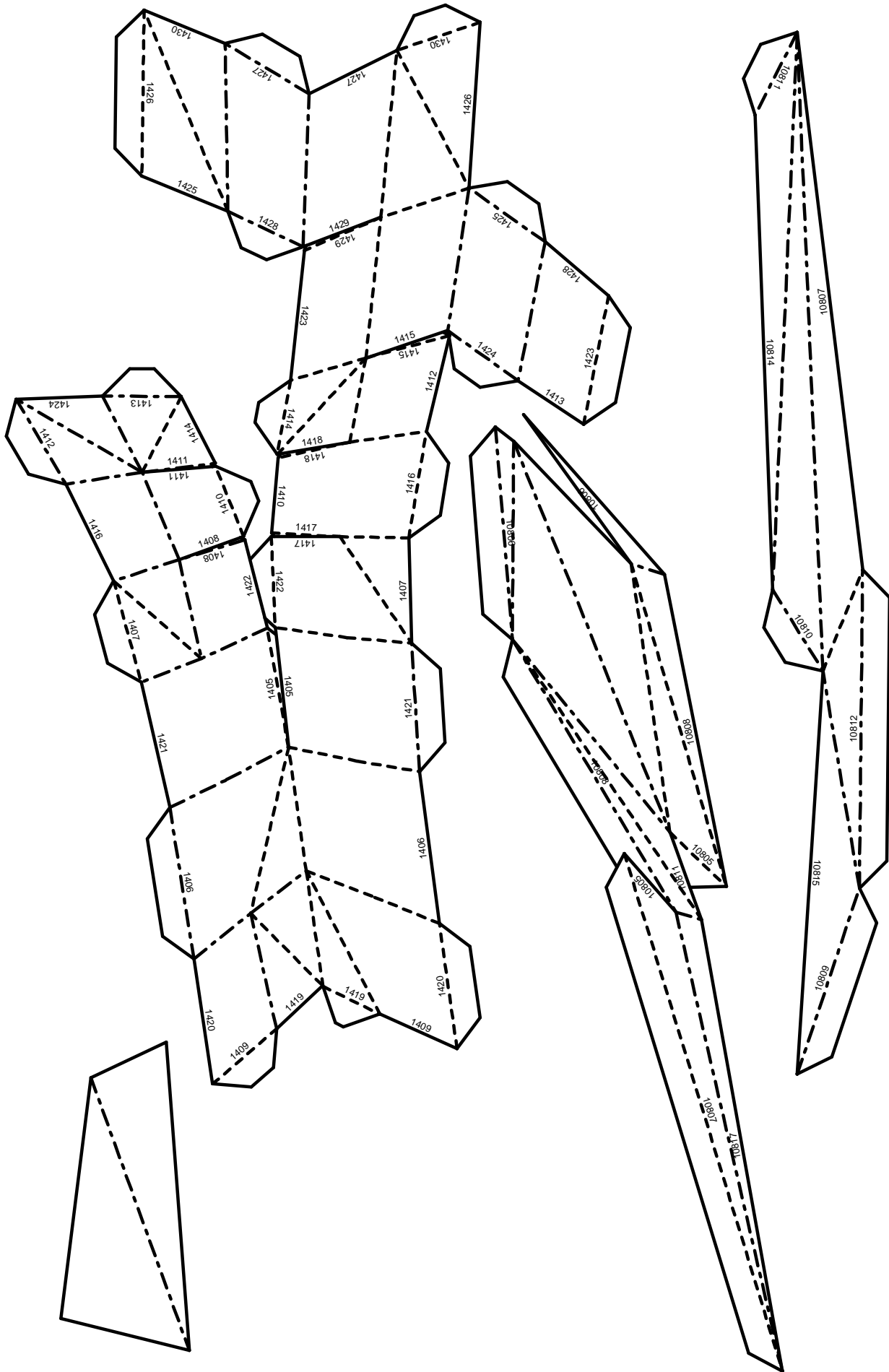

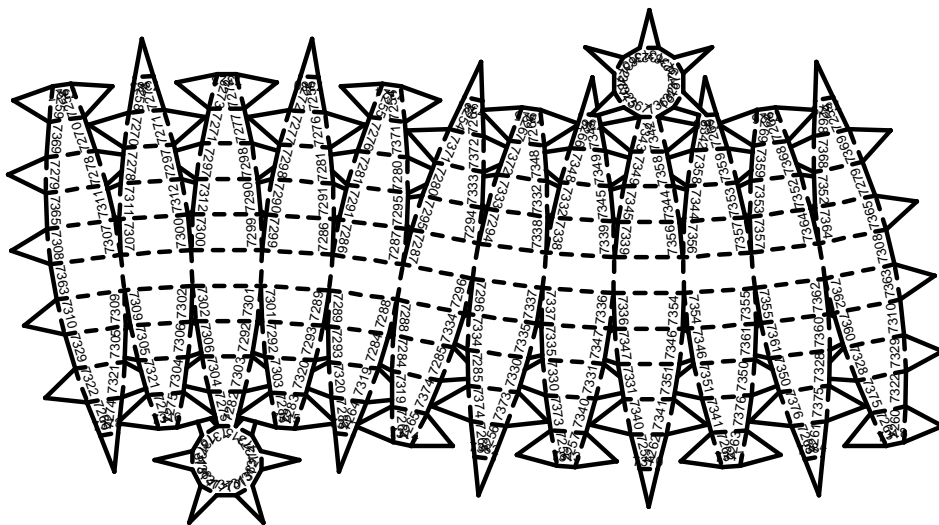
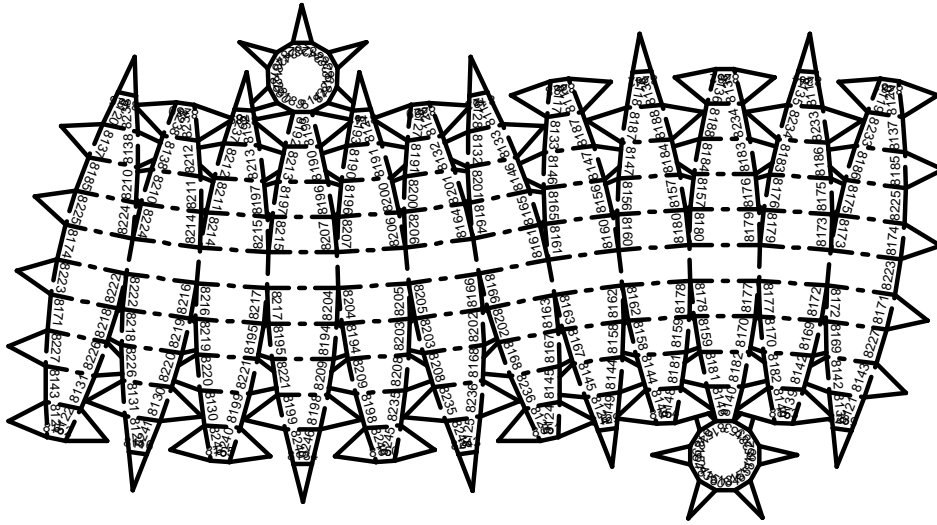
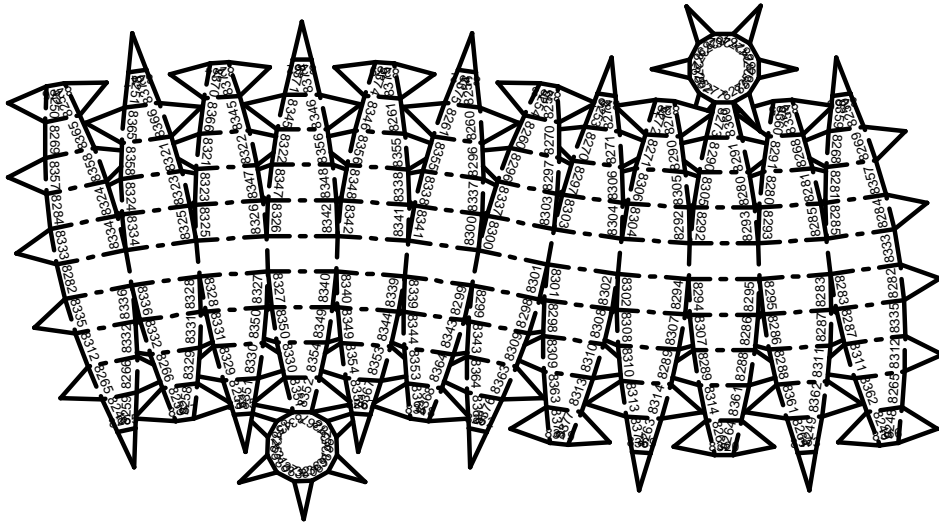

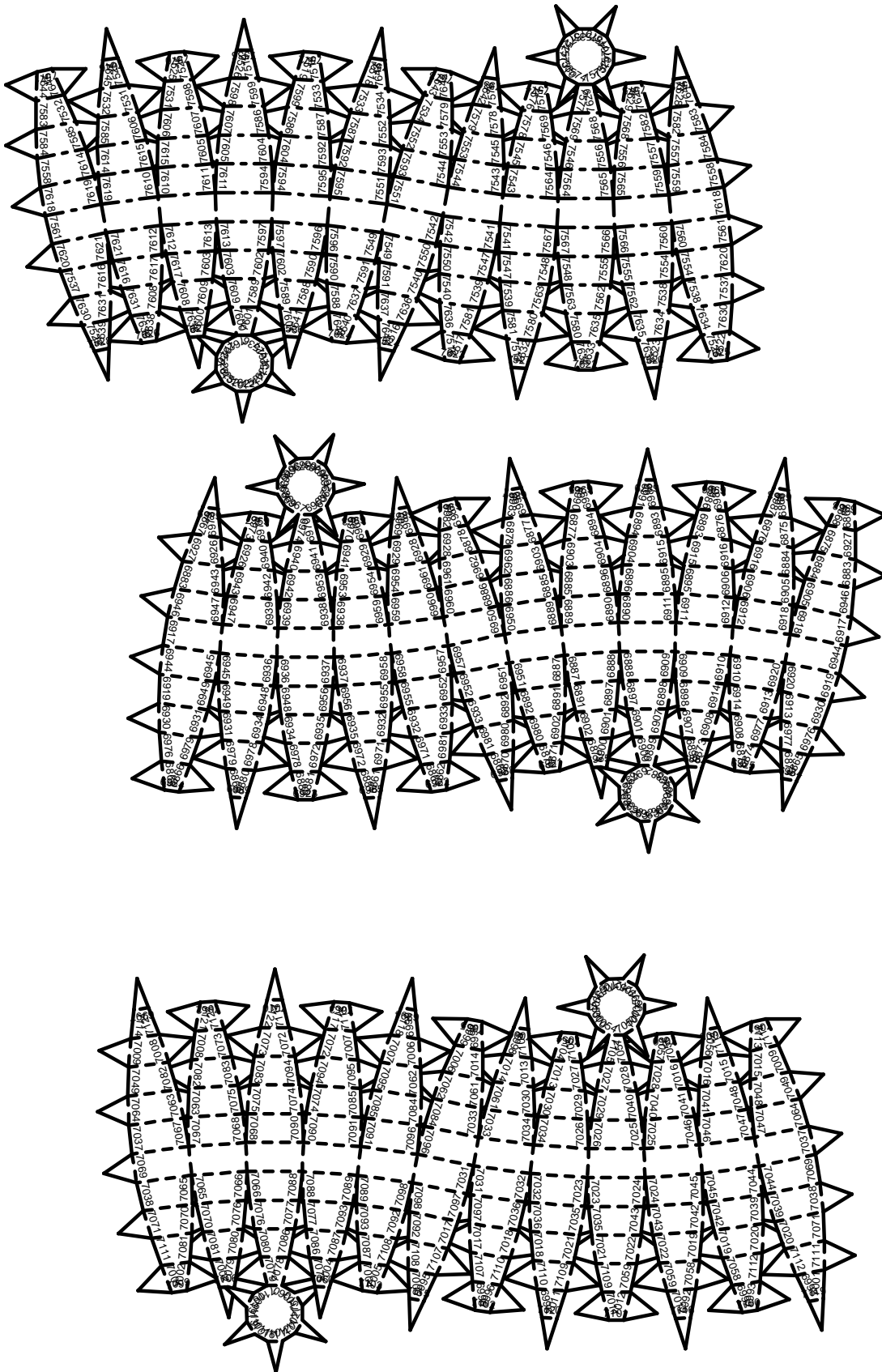

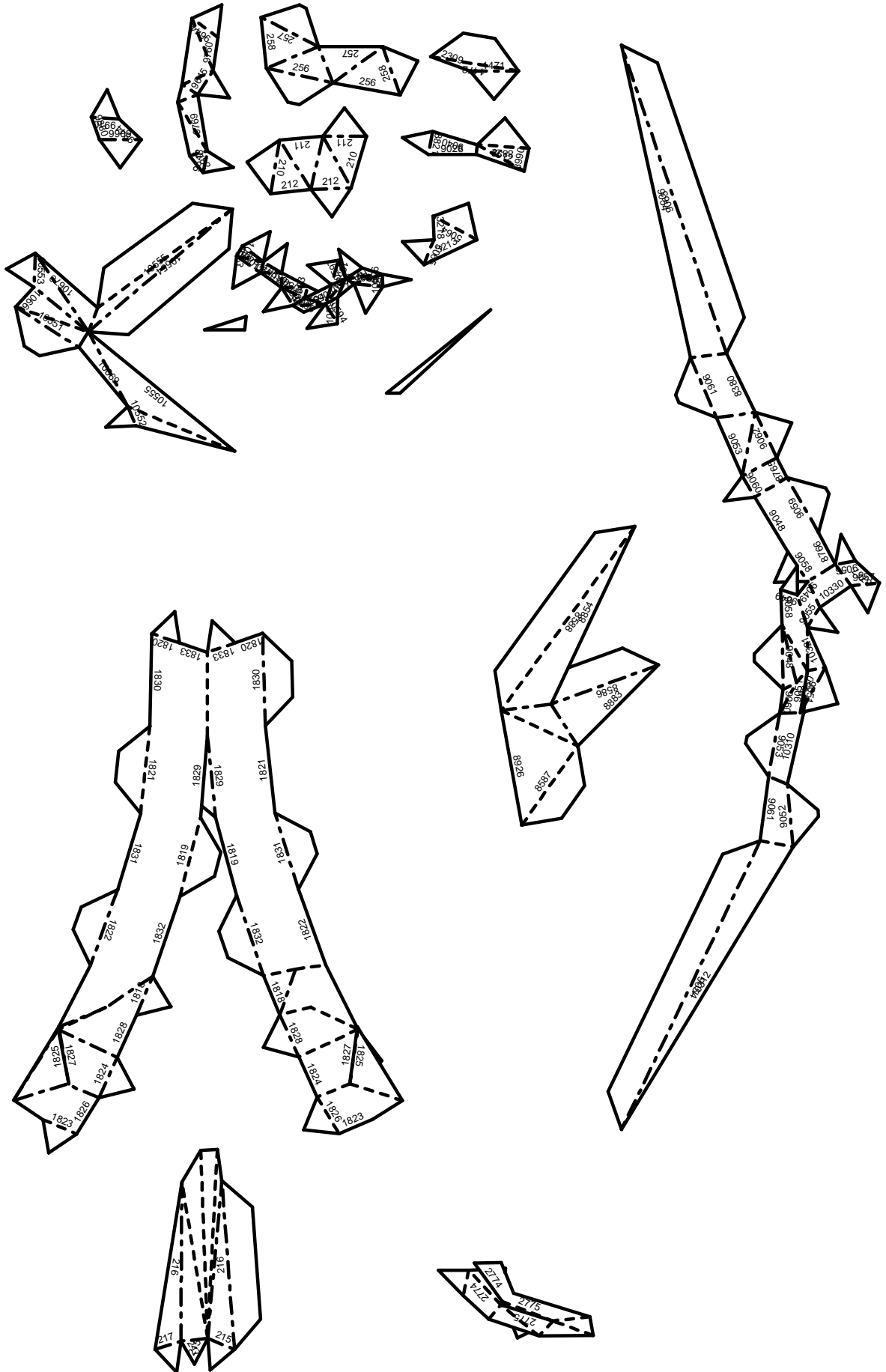

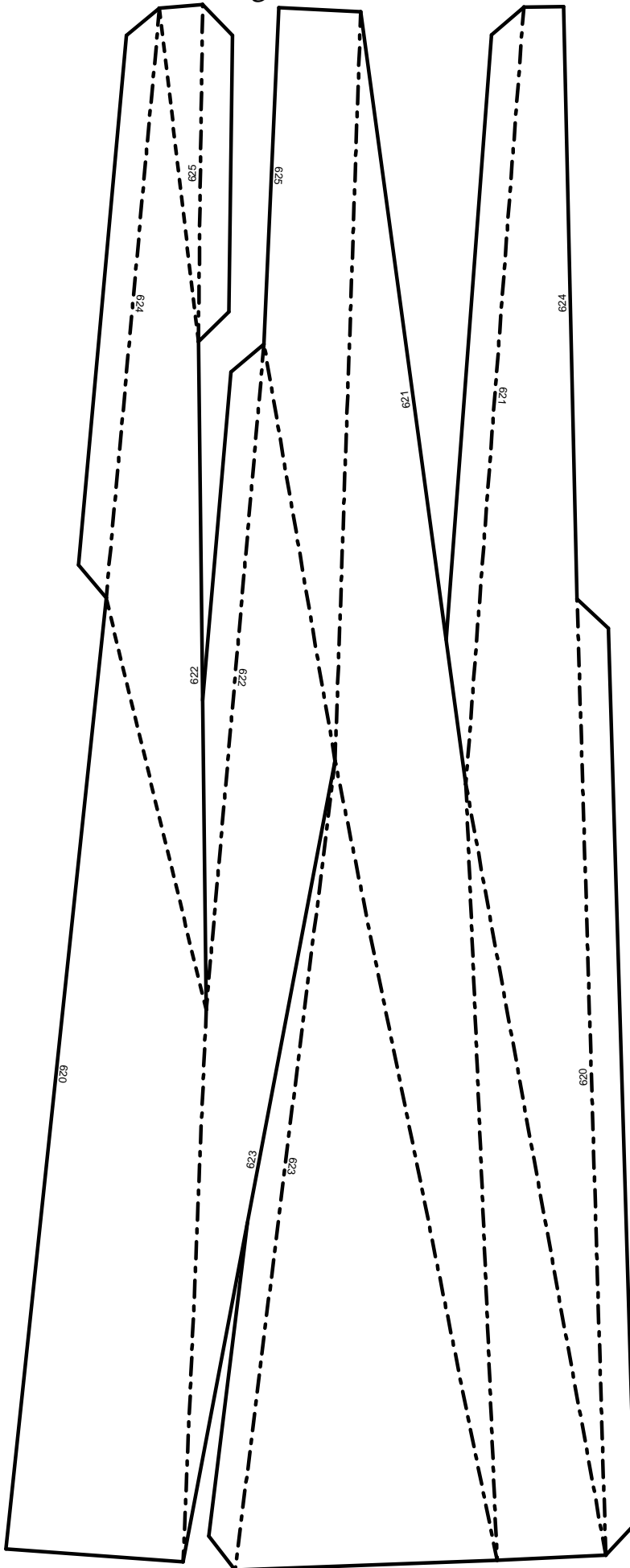

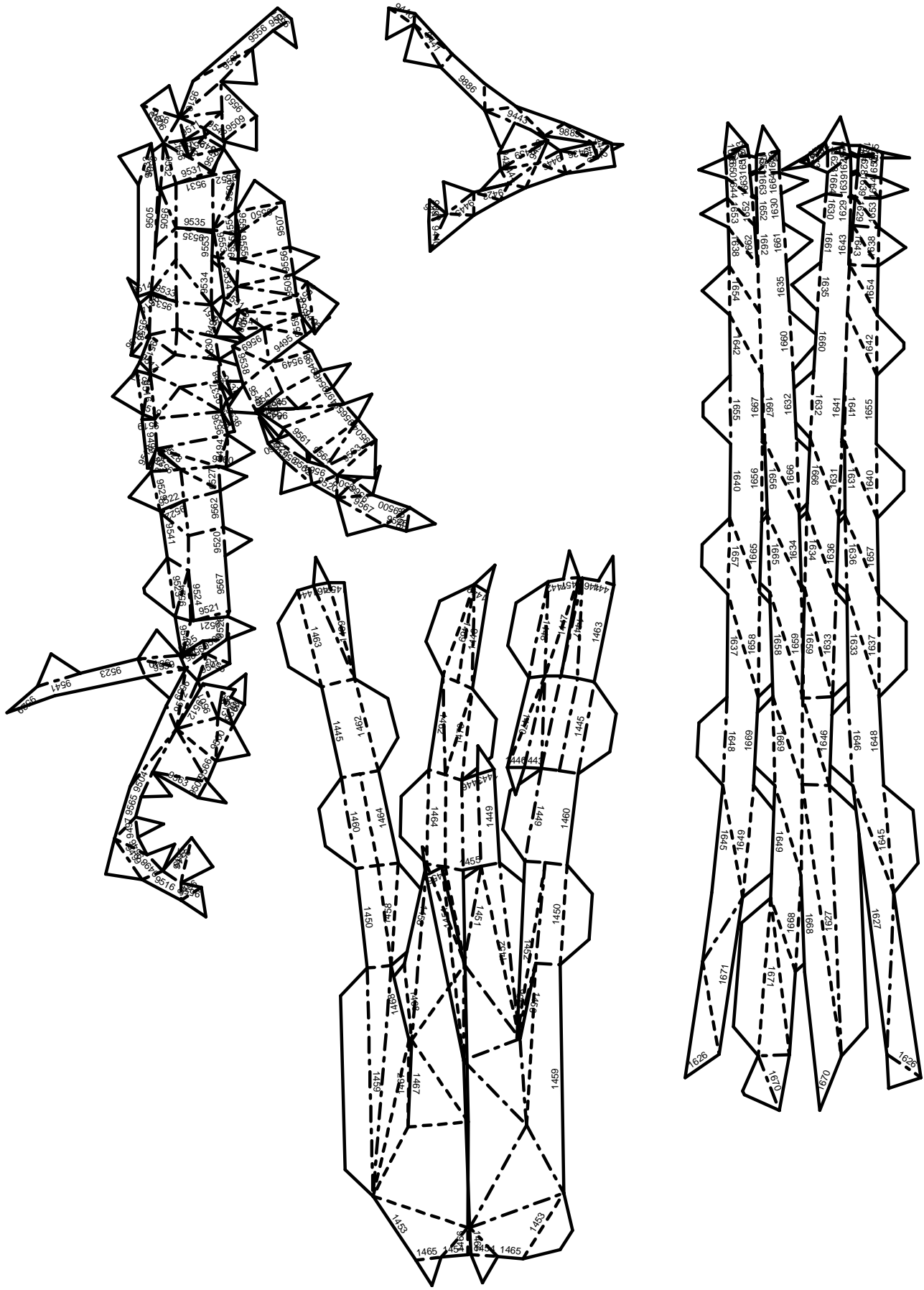

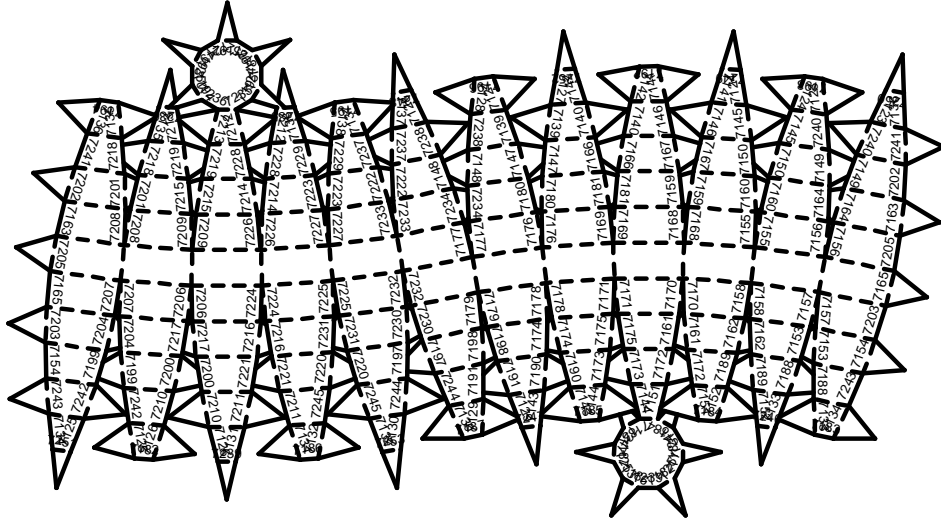
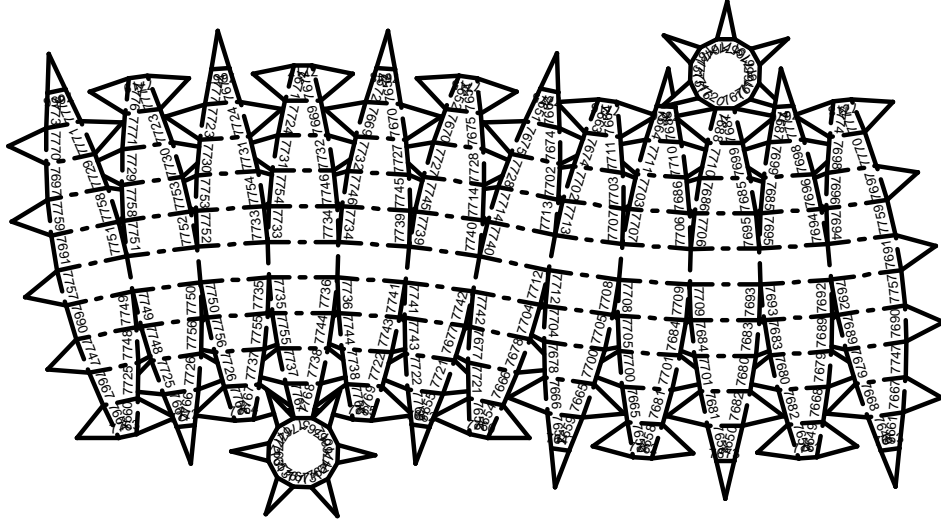
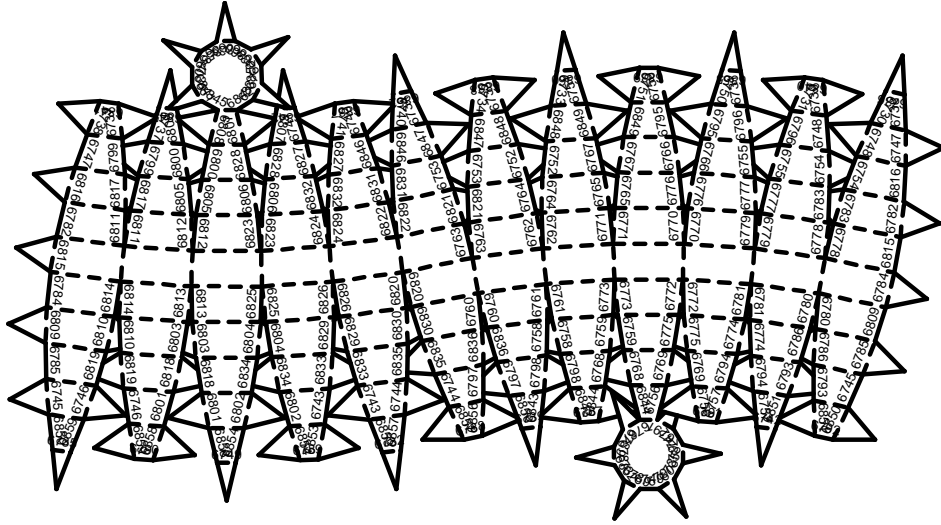

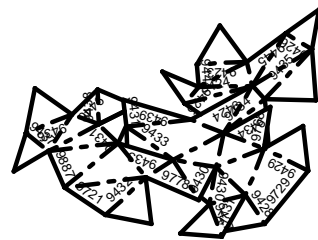
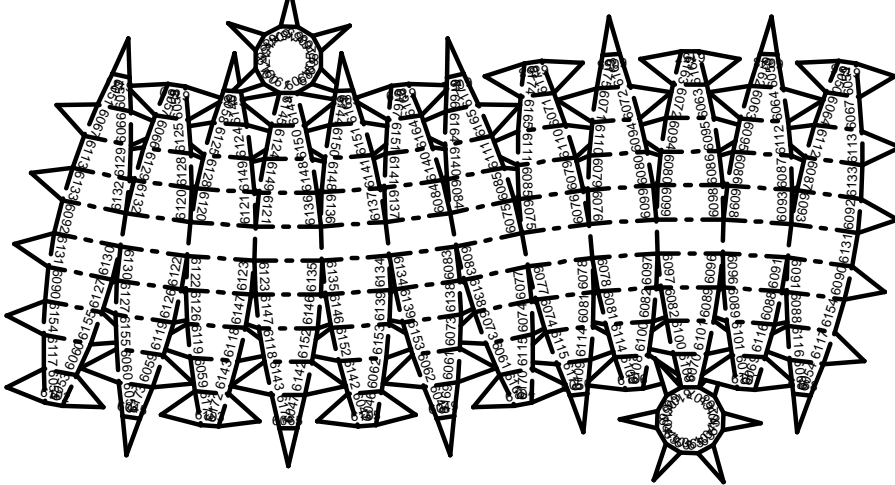
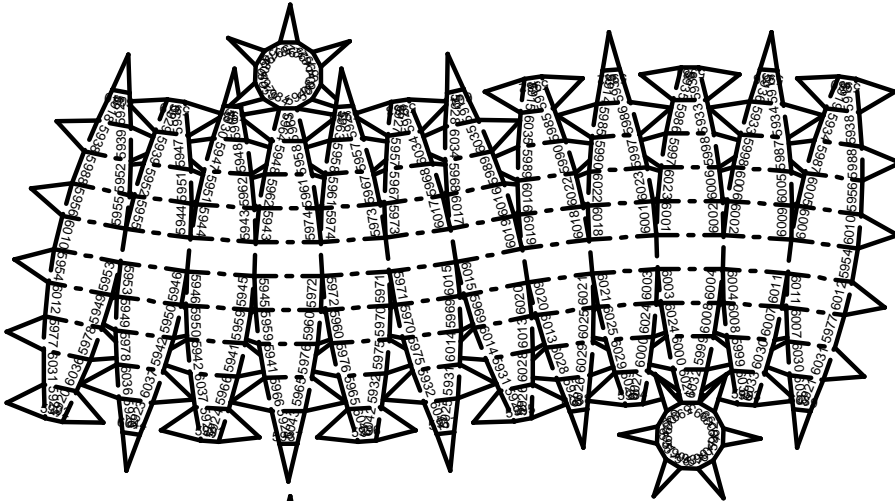
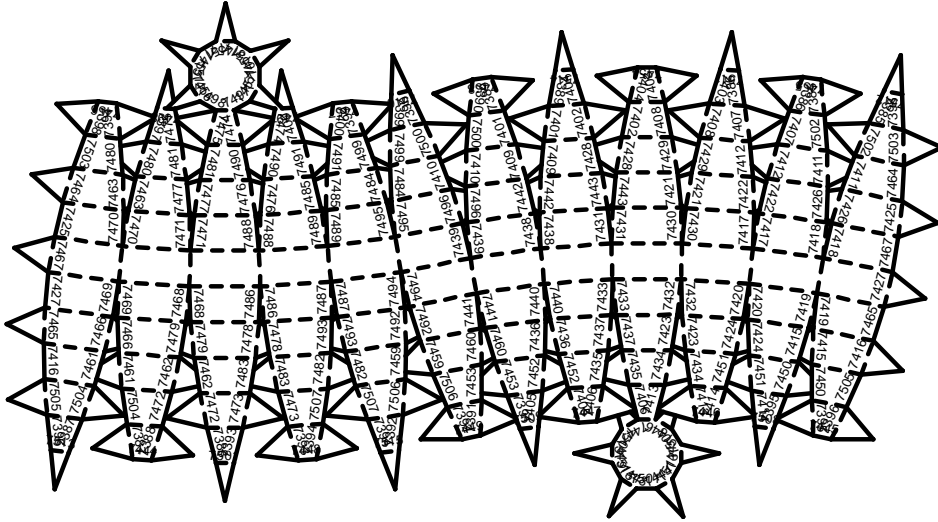

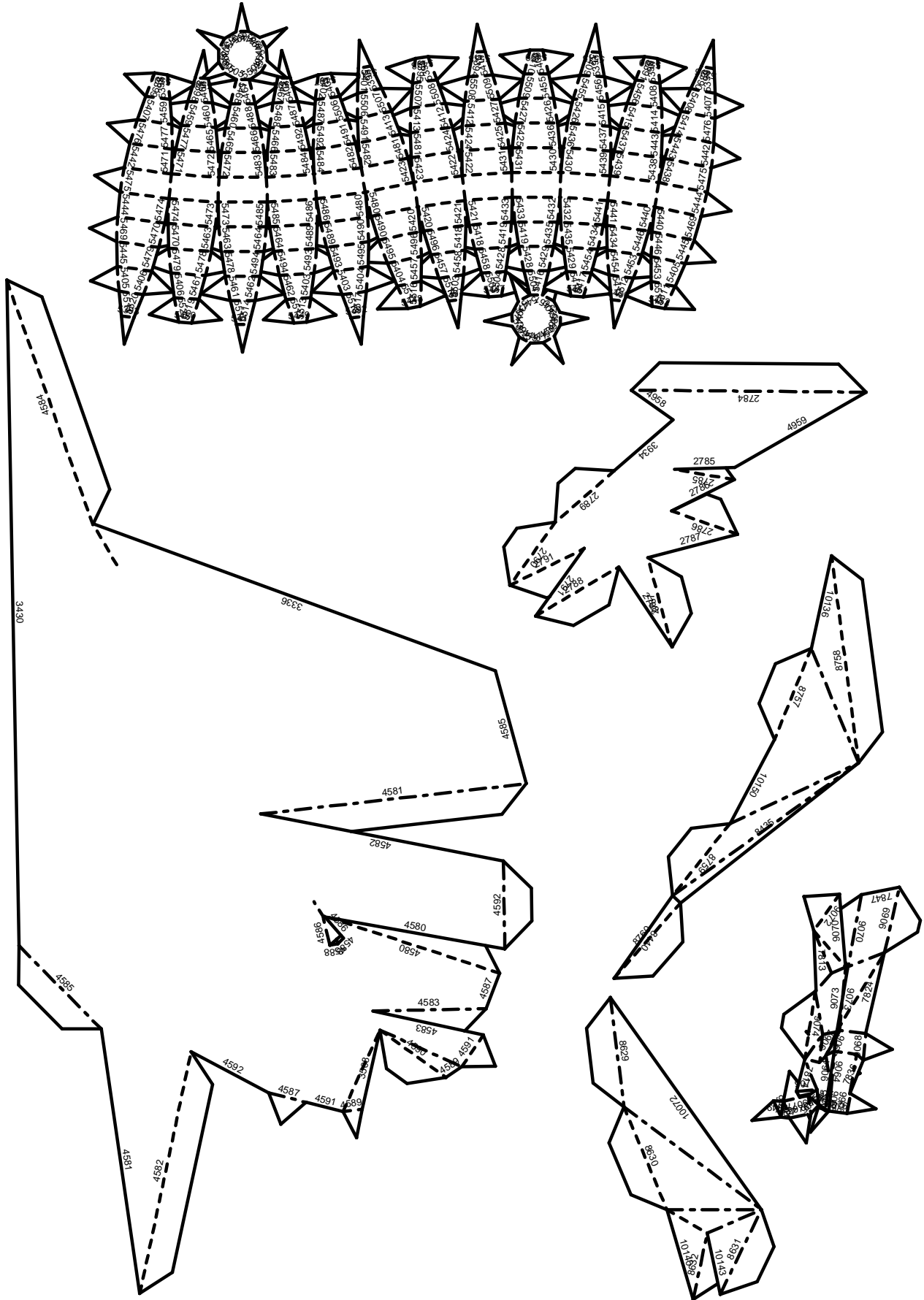

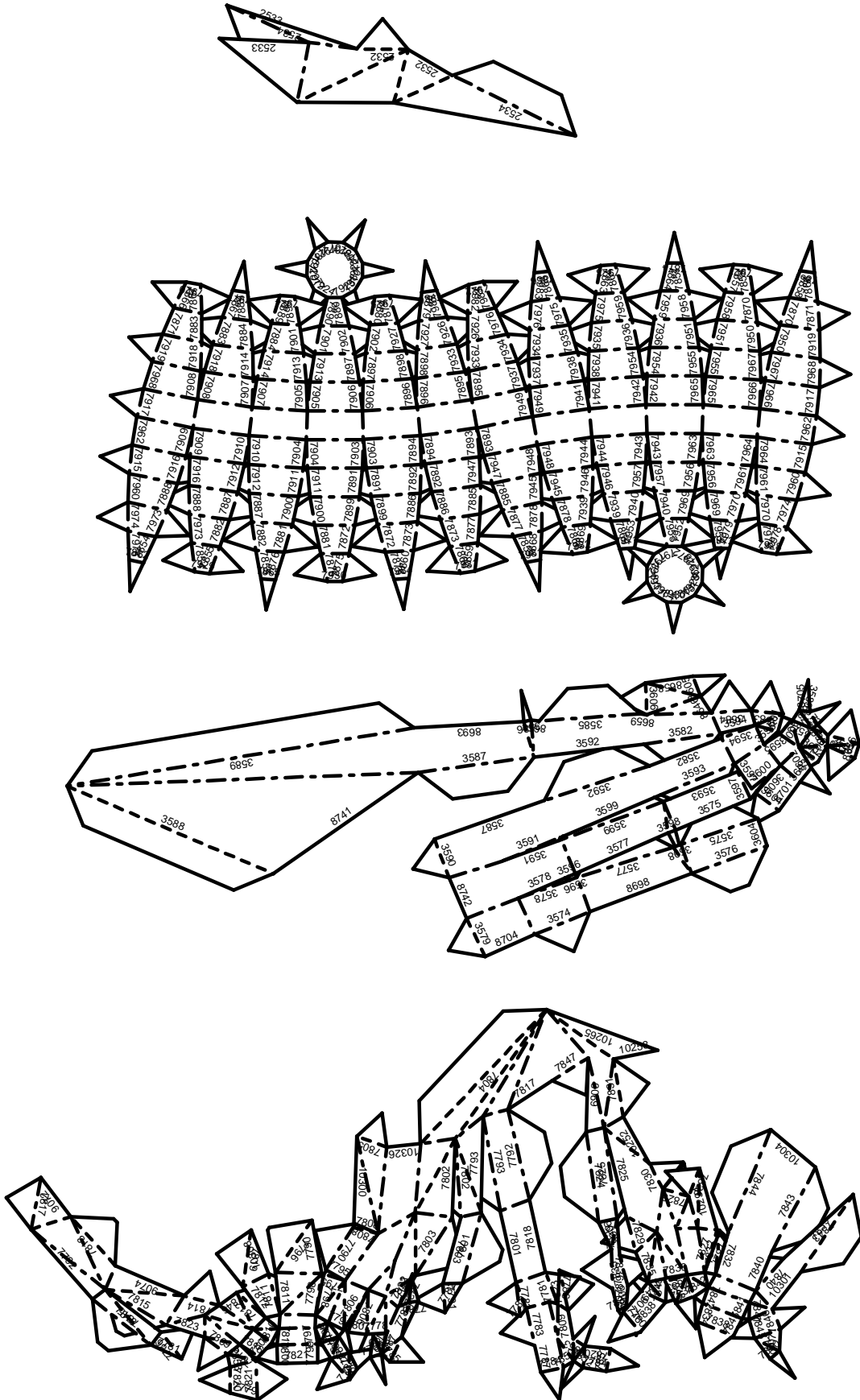

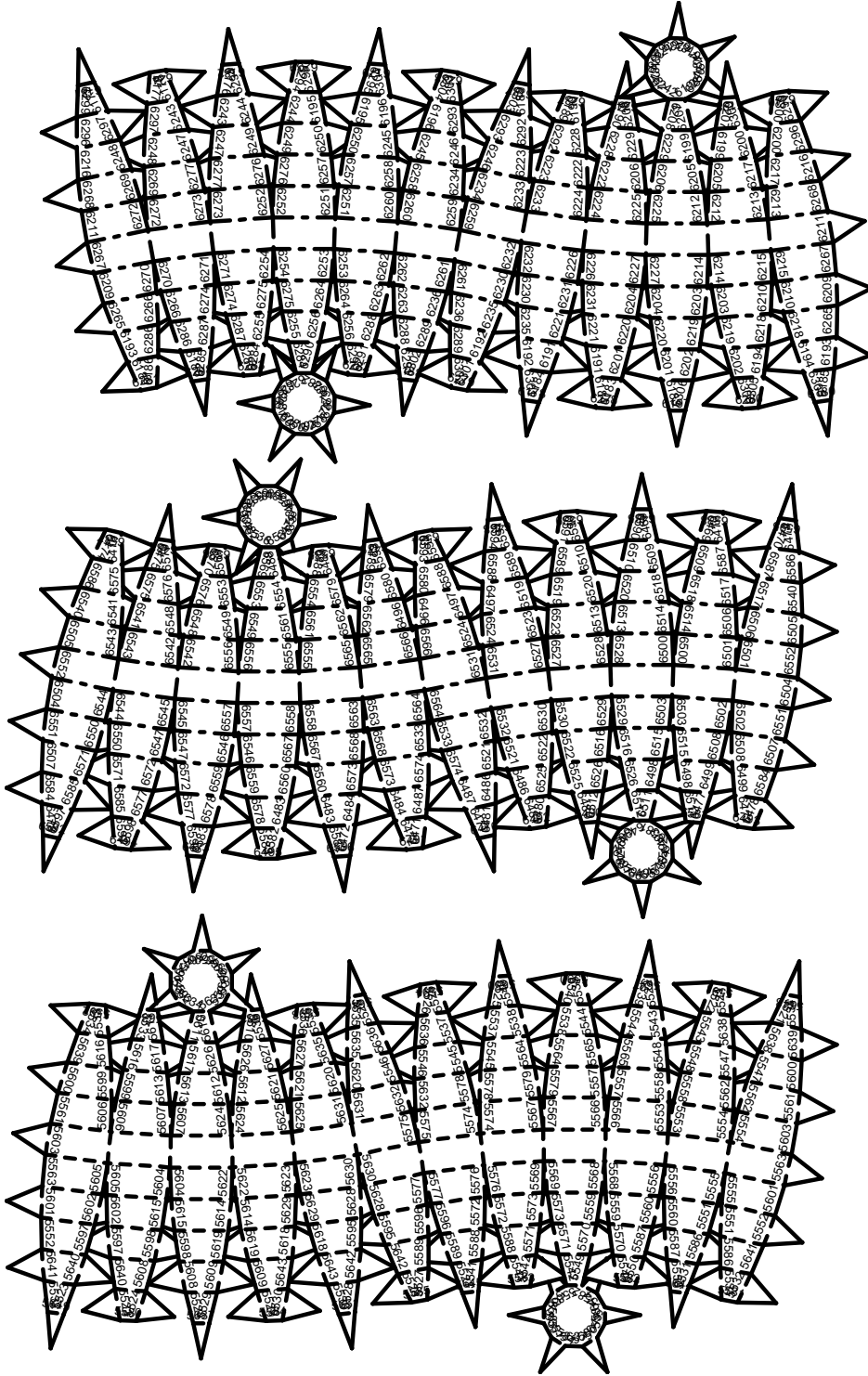

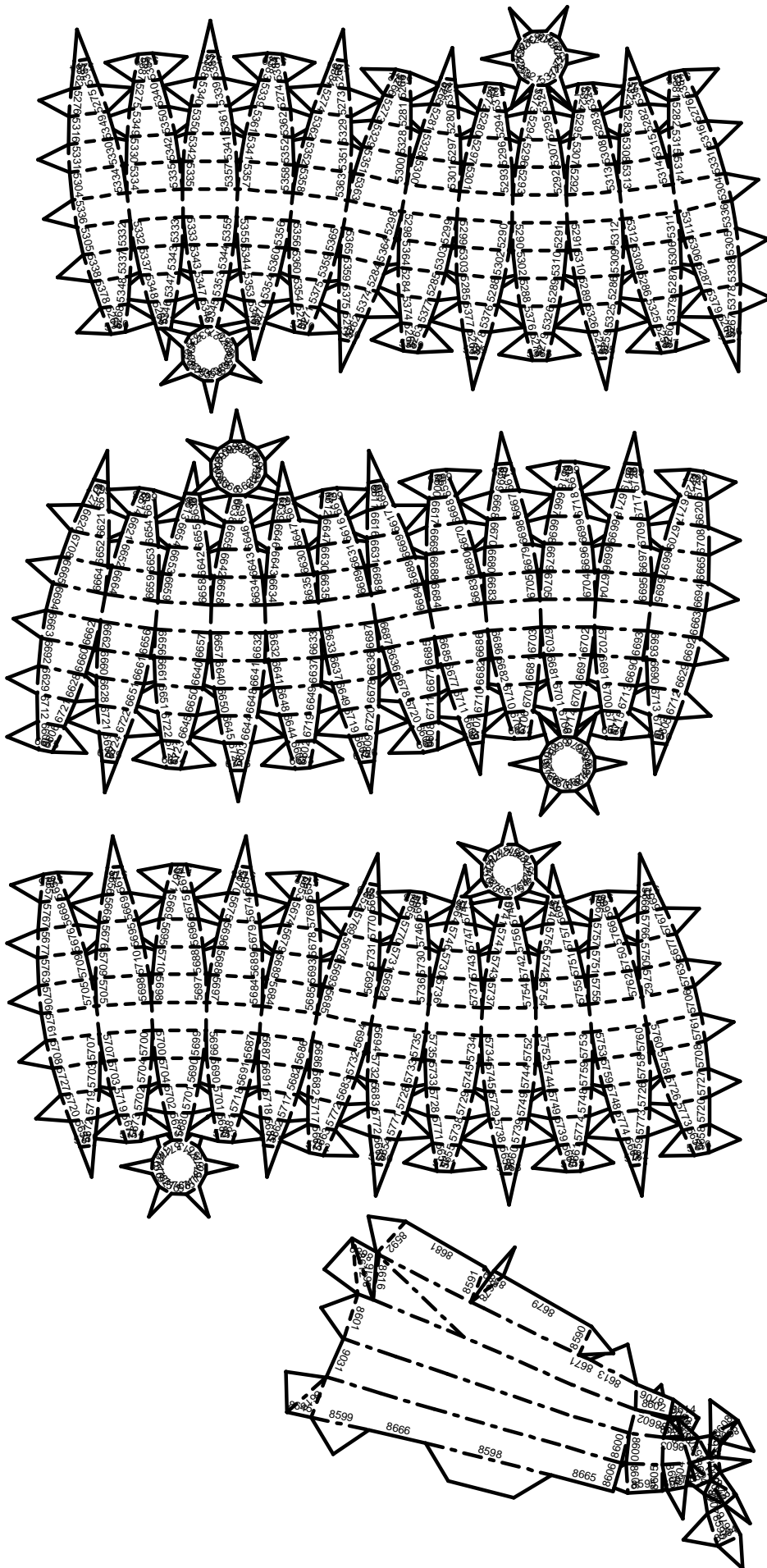

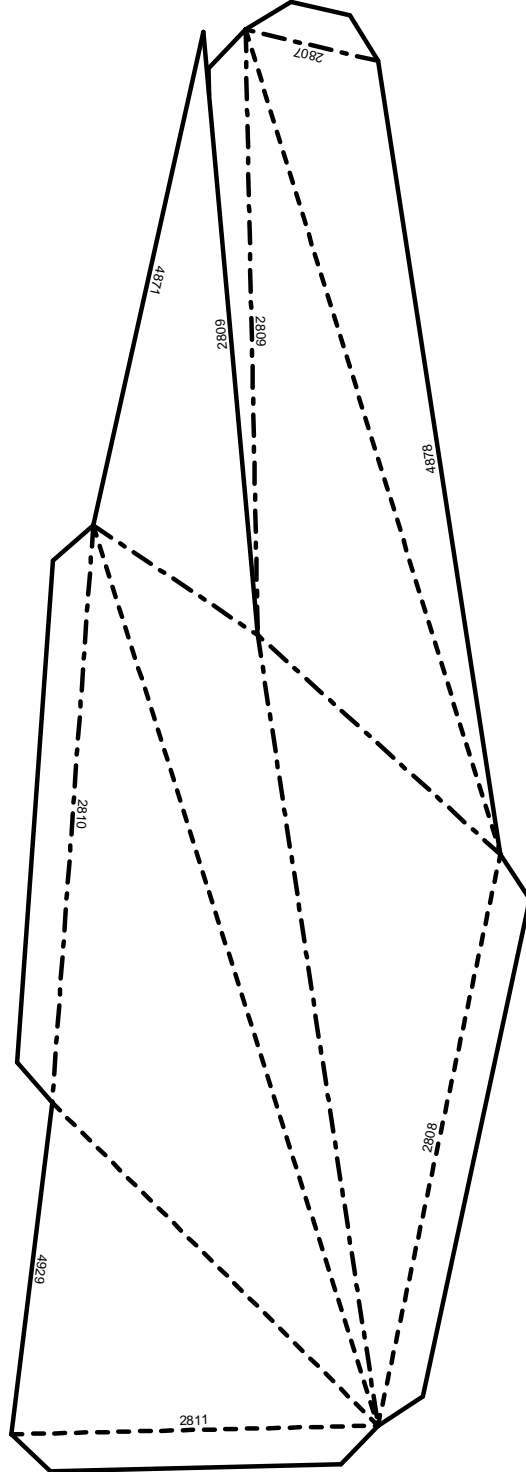
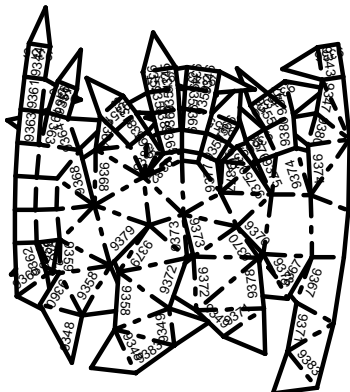
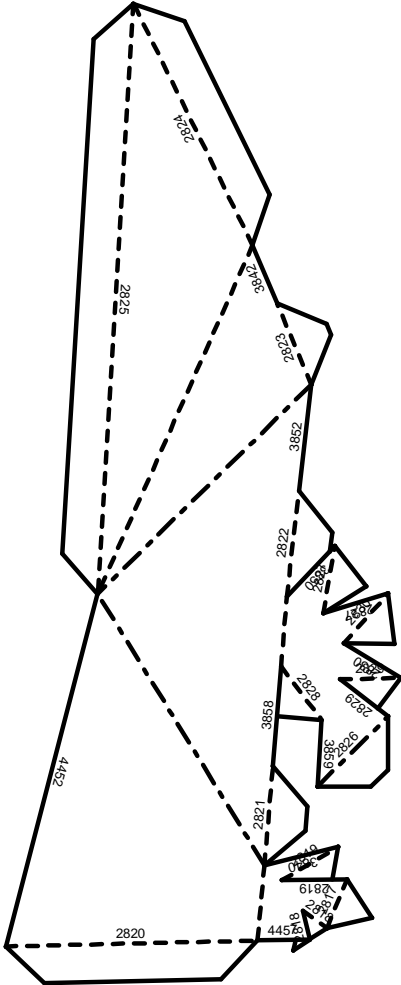
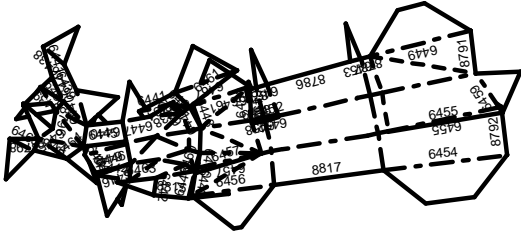

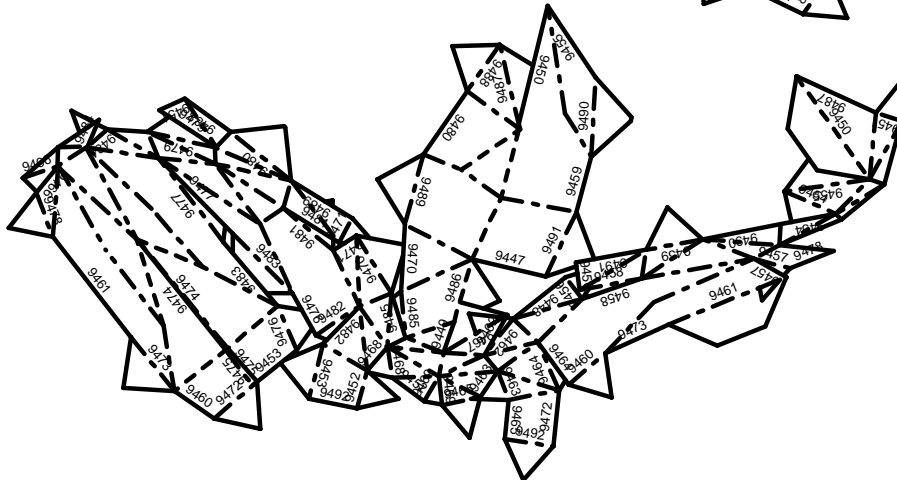
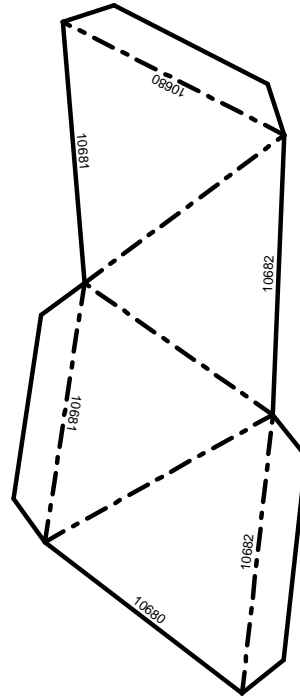
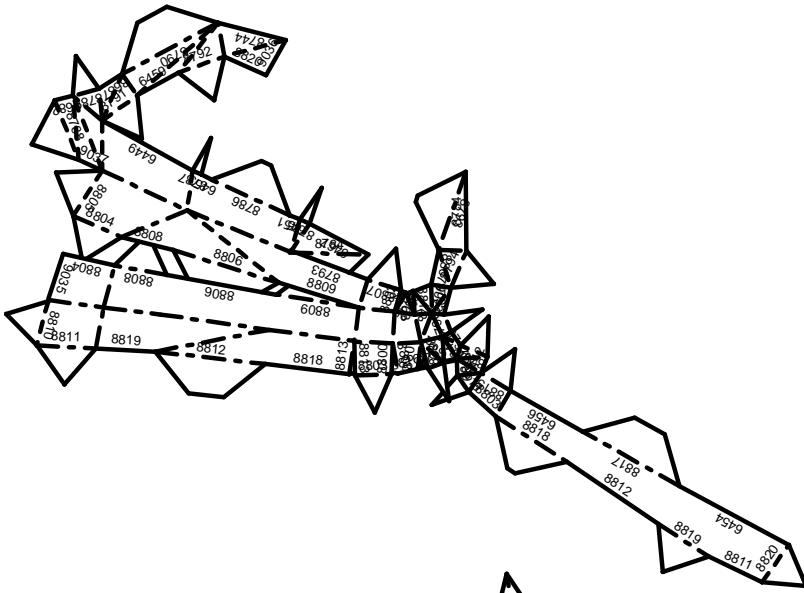
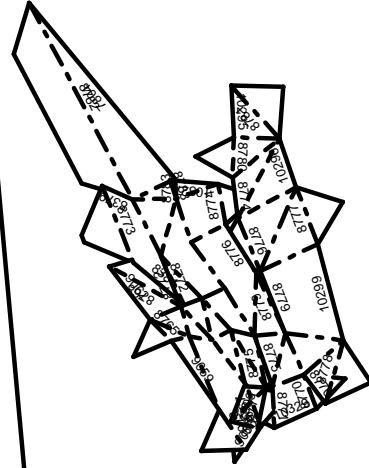
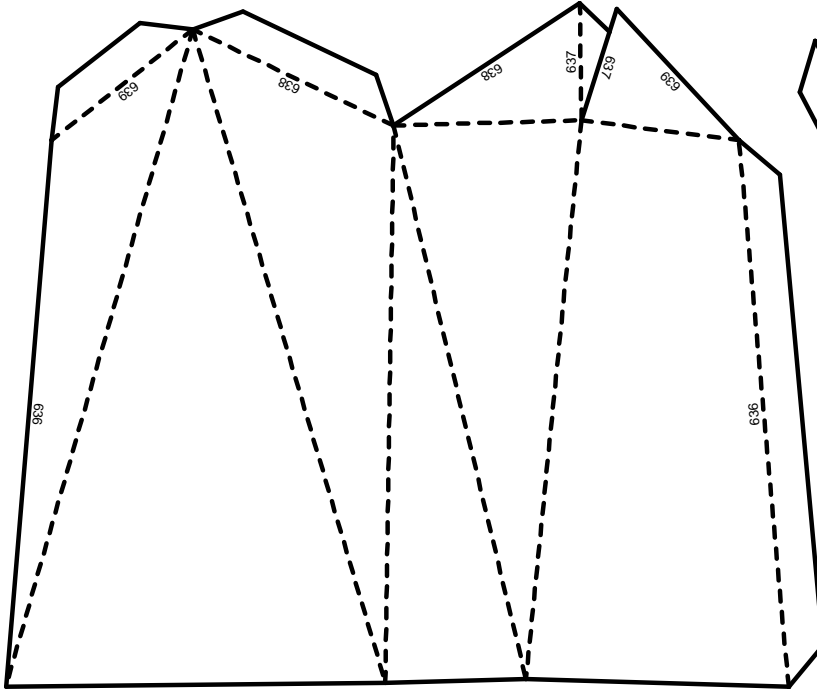

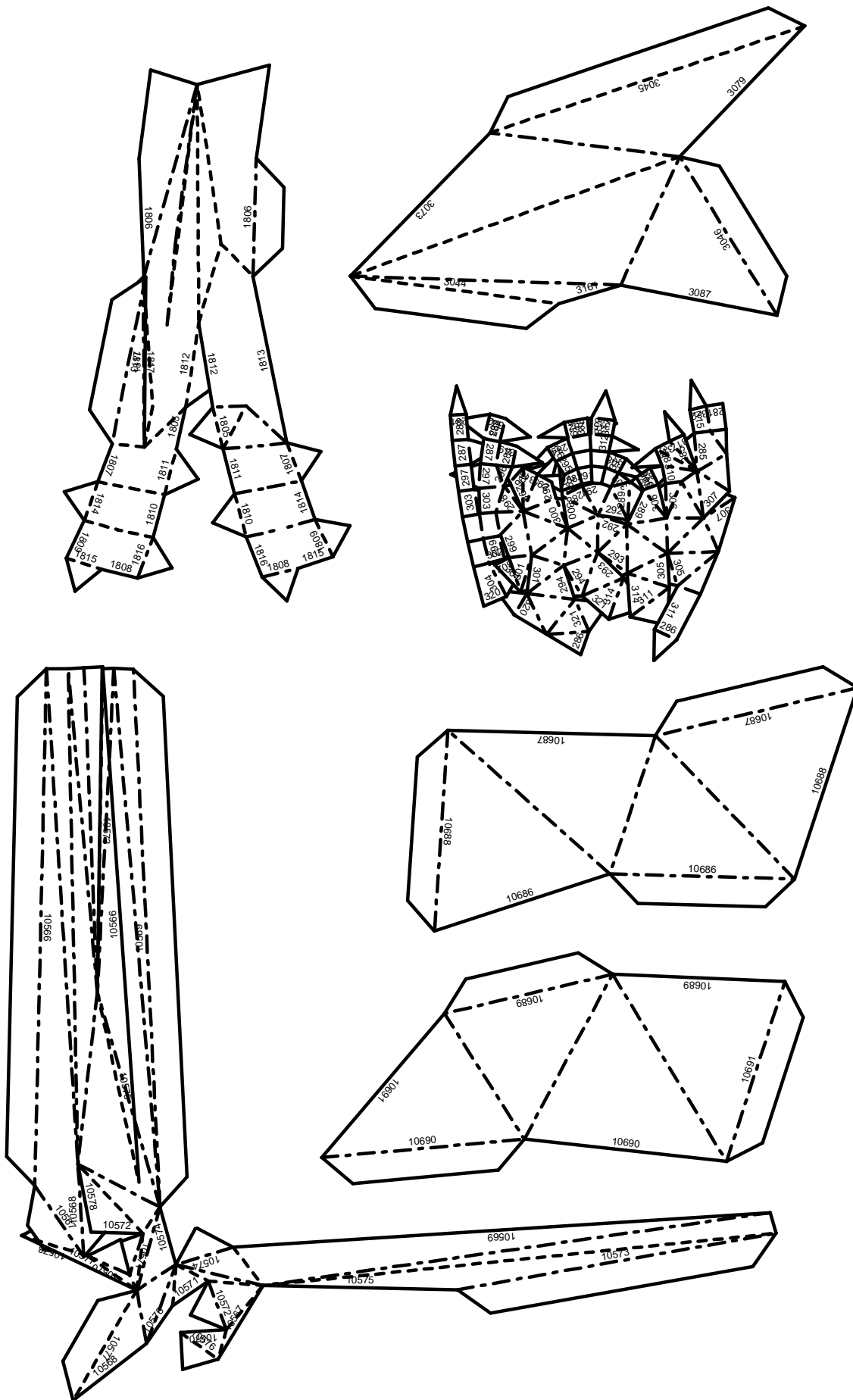

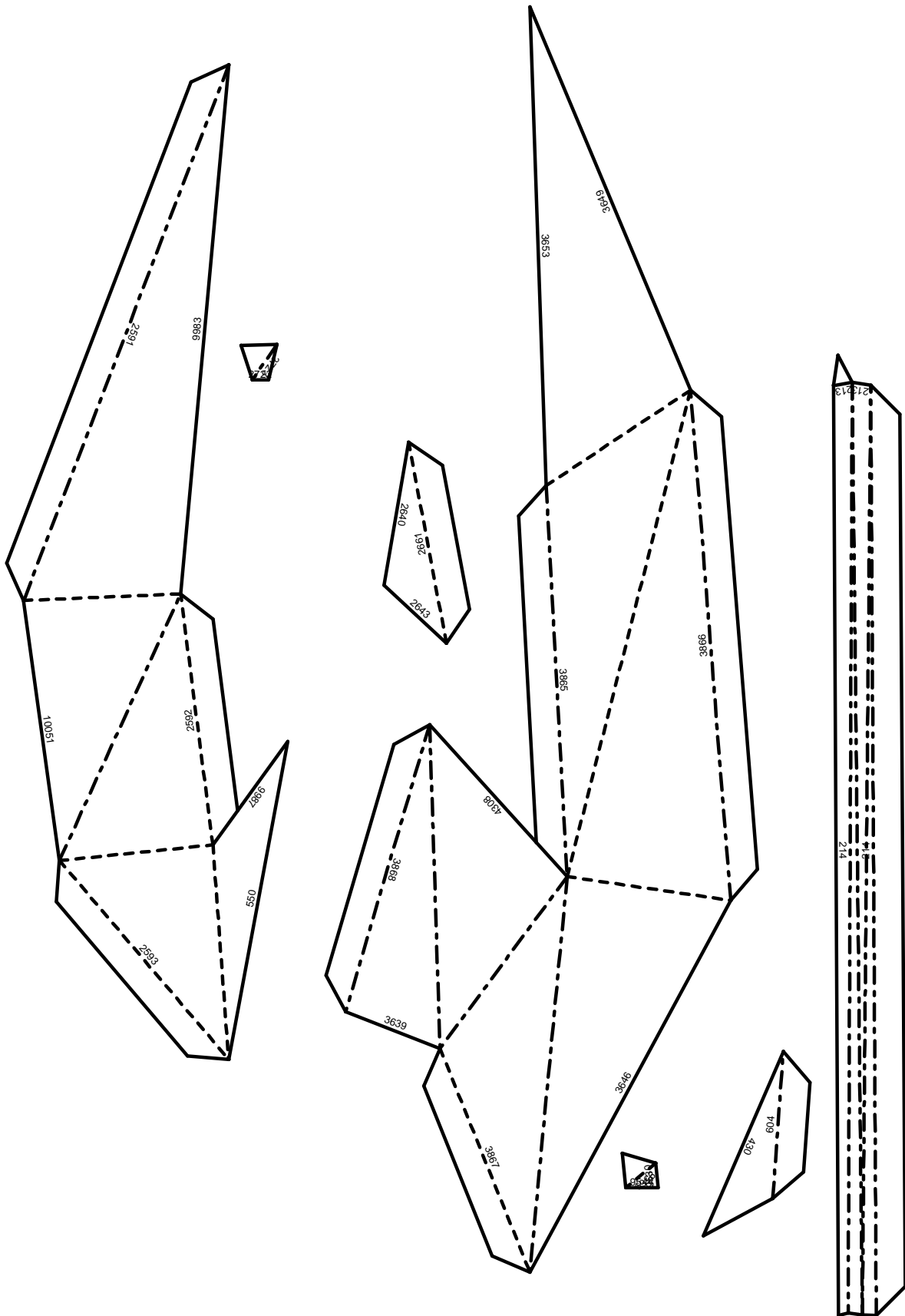

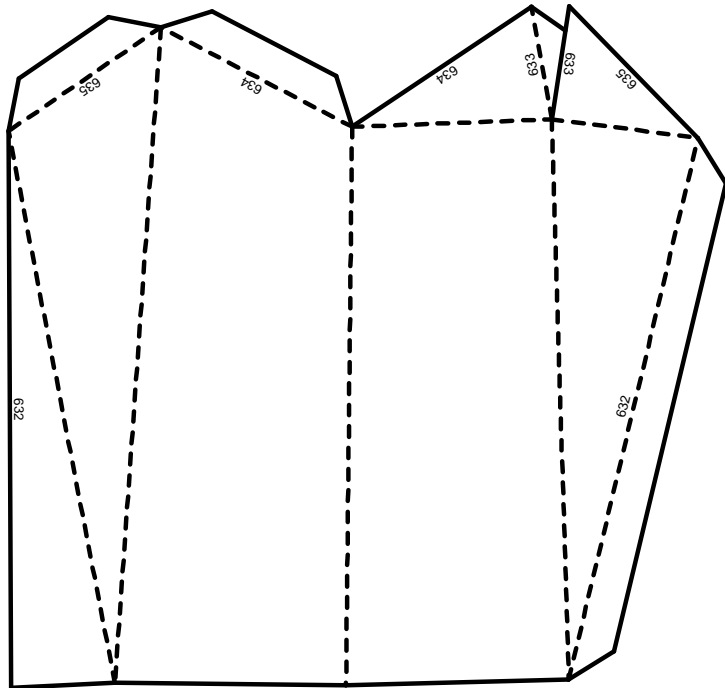
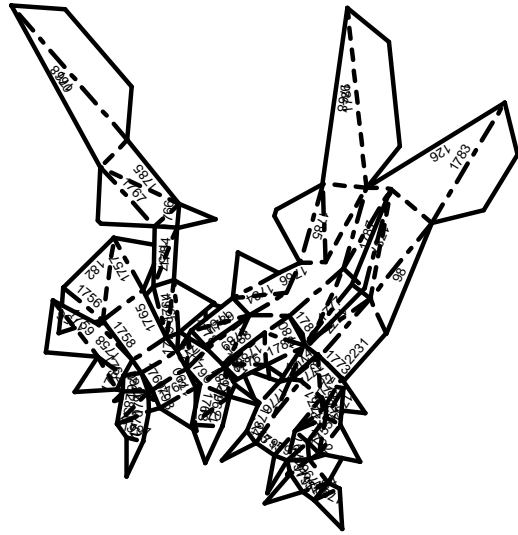
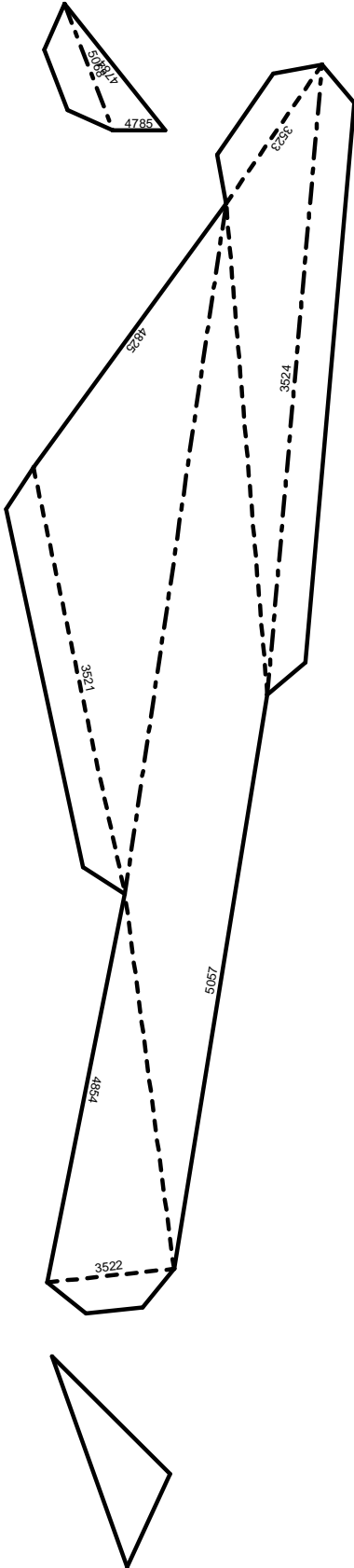

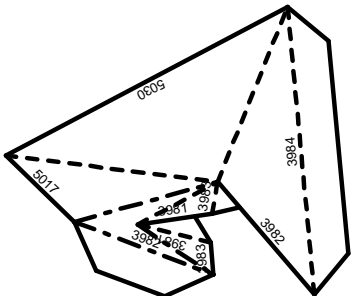
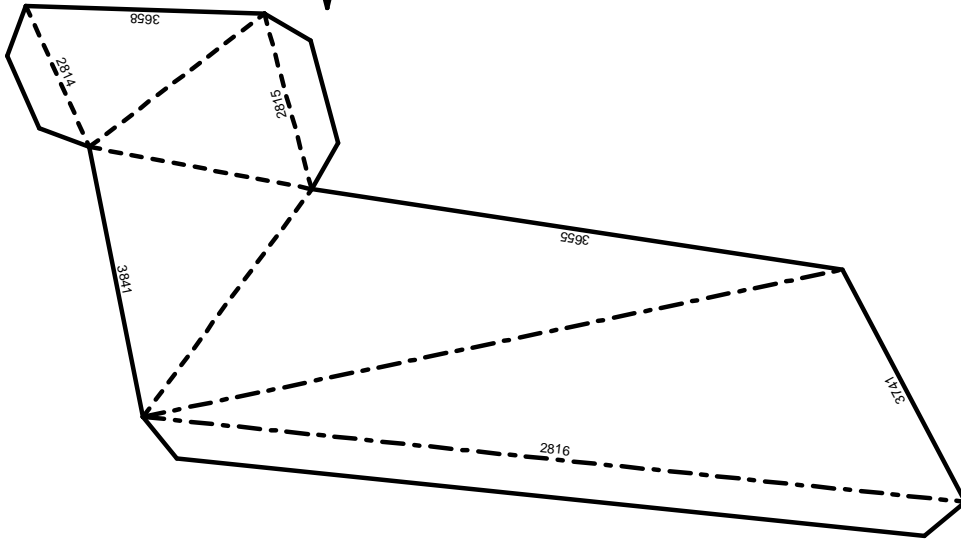
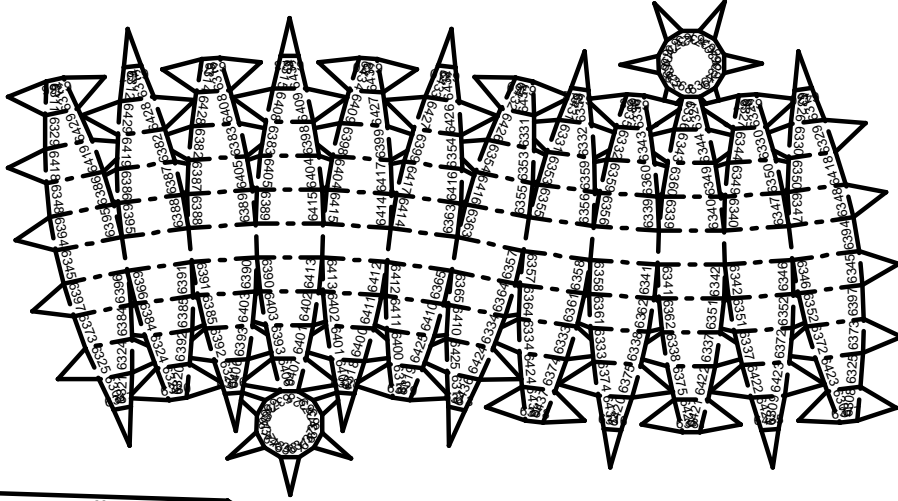
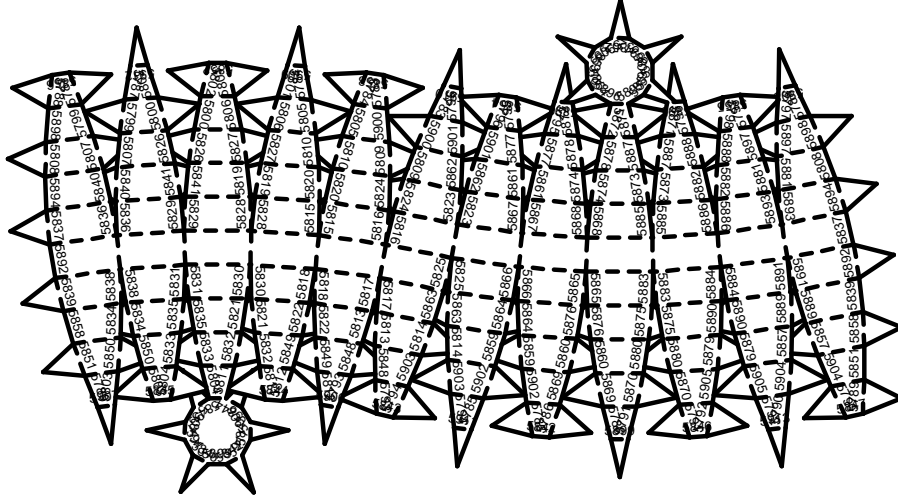

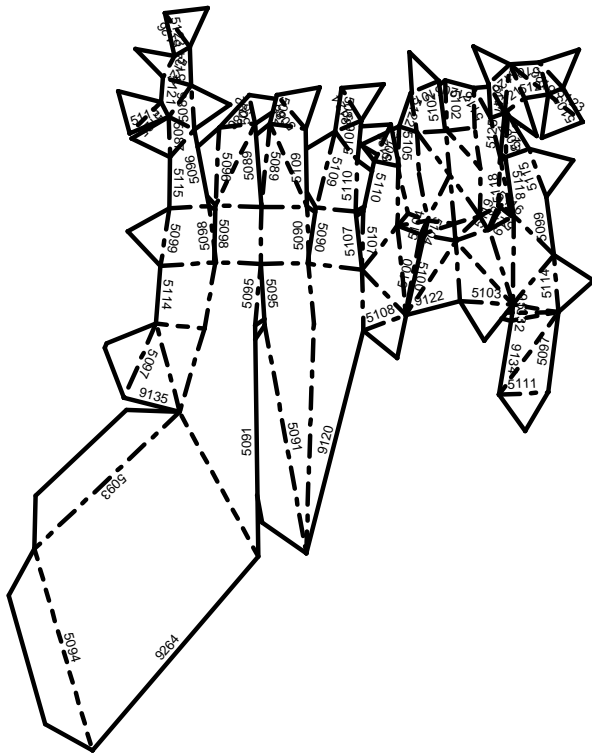
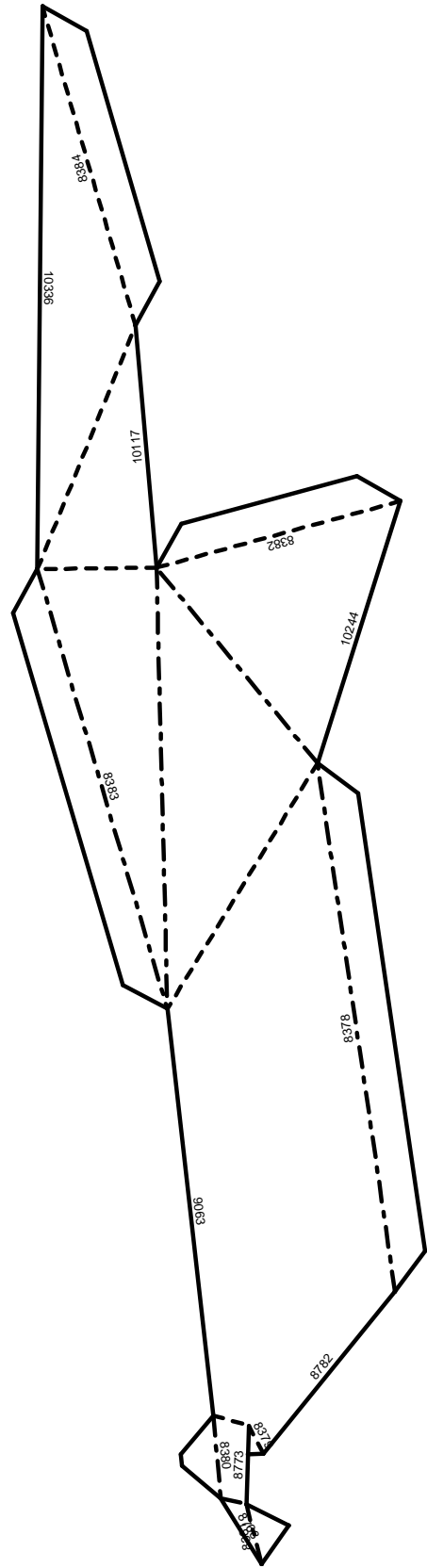
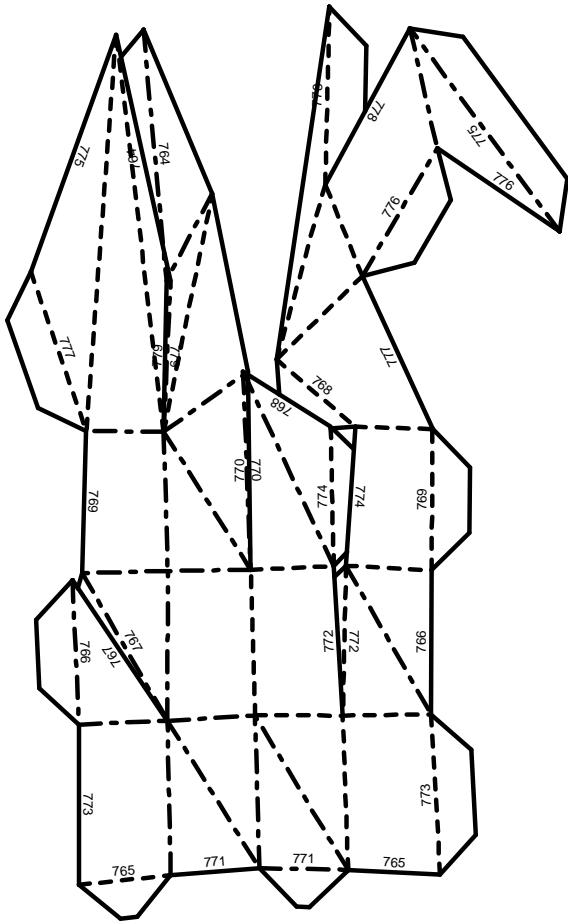

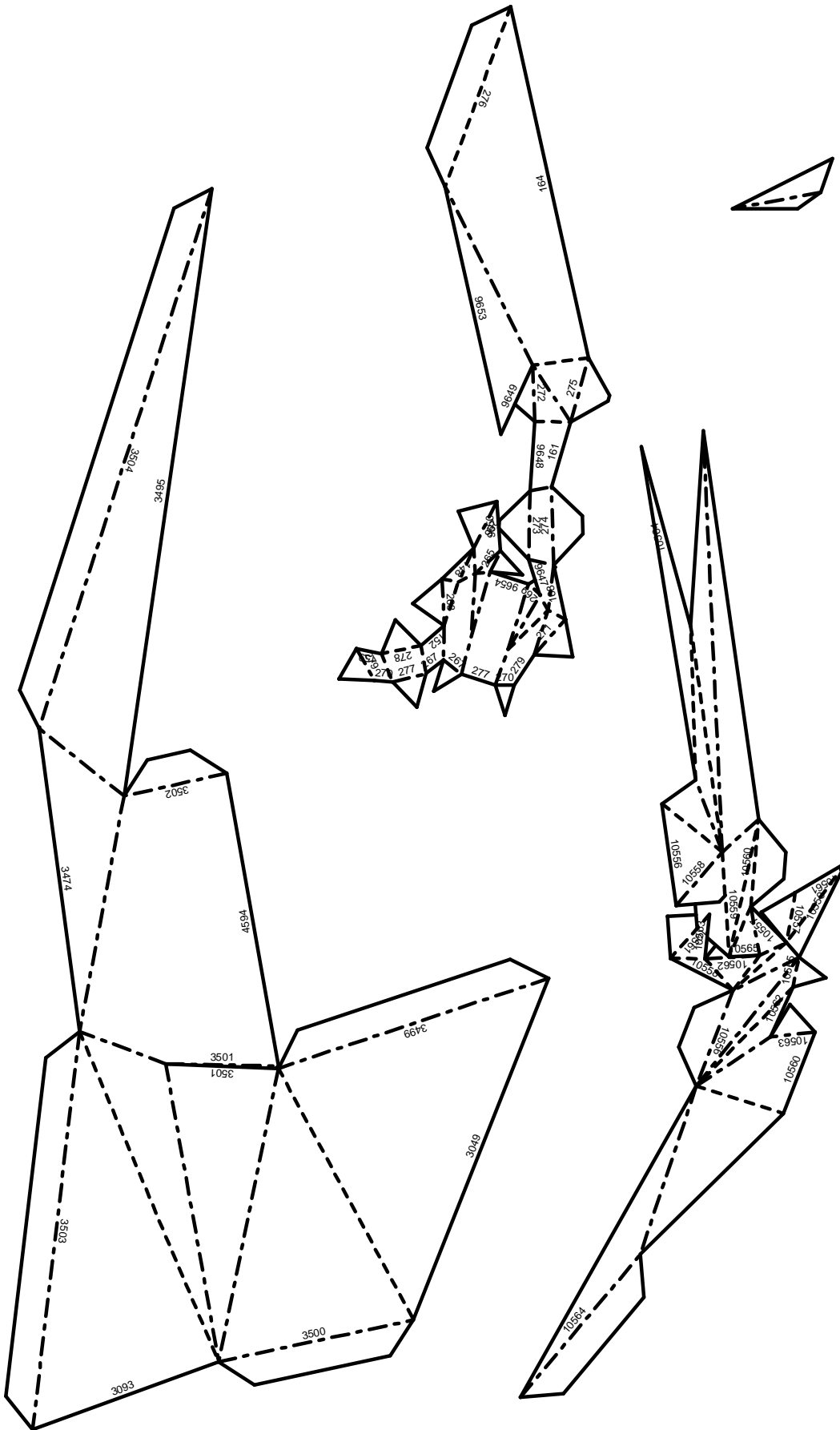

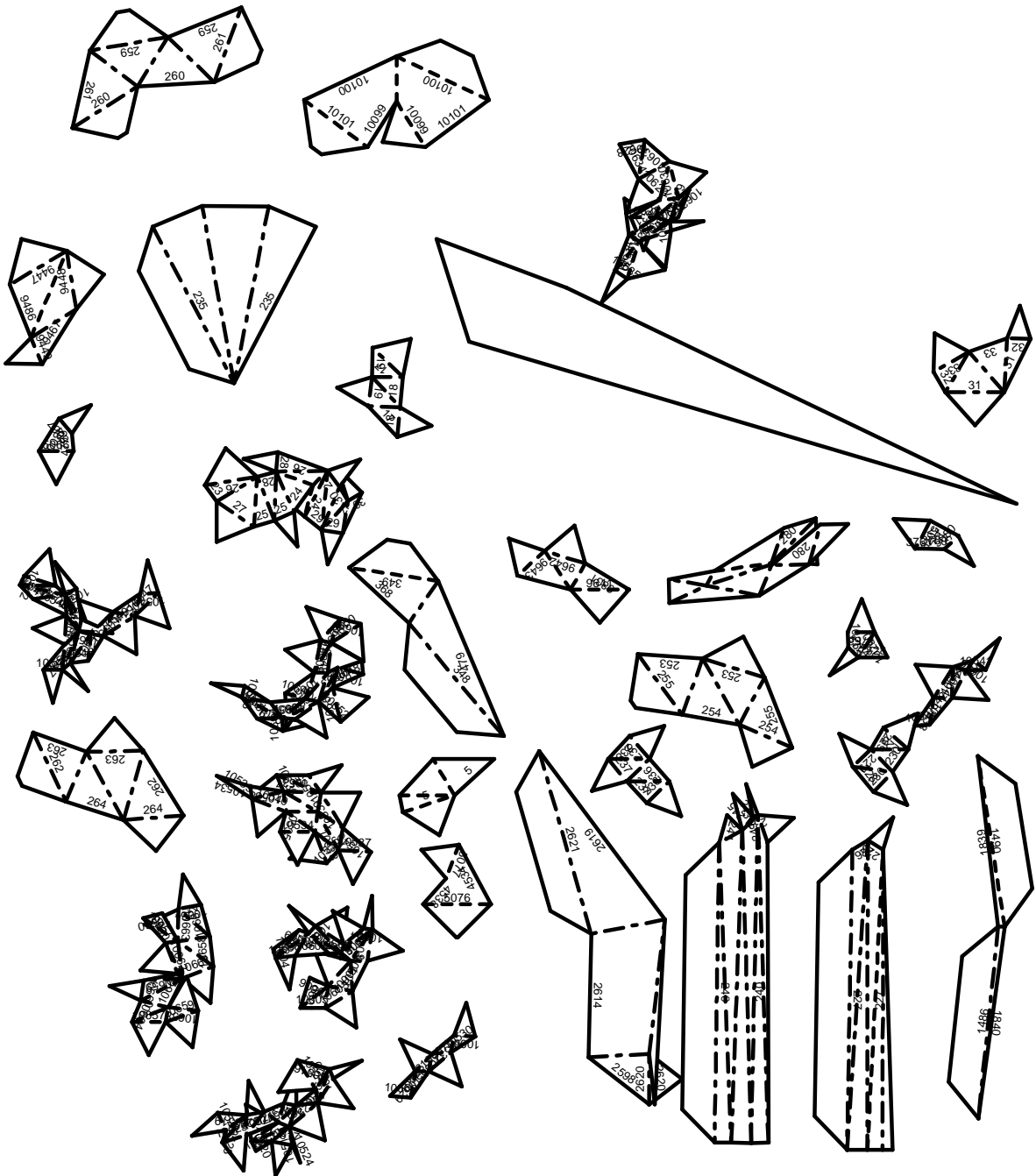

This document was created with Win2PDF available at <http://www.win2pdf.com>.
The unregistered version of Win2PDF is for evaluation or non-commercial use only.
This page will not be added after purchasing Win2PDF.