



SPECIFICATIONS

Supply Voltage : 20 to 240V AC/DC (50/60Hz)

Time Ranges : 99:9 Sec, 999 Sec, 9:59 M:S,
99:9M, 999 M, 9:59 H:M,
99:9 H, 999 H

Counting Direction : Down

Accuracy : $\pm 0.1\%$ of set time or $\pm 50\text{msec}$
(Whichever is greater)

For Y contact operation : +100msec

Repeat Accuracy : $\pm 0.1\%$

Relay : 1 C/O (SPDT)

Reset Time : 100ms

Initiate Time : 30ms

Memory Retention : Selectable

Temperature : Operating : 0 to 50°C.
Storage : -20 to 75°C

Humidity : 95% RH.

Housing : Flame retardant
engineering plastic

Weight : 70 gms

FRONT

PANEL

DESCRIPTION

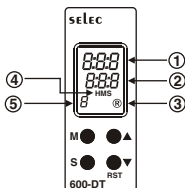

	On line	Config.	Front Reset
①	Process time	Parameter name	
②	Set time	Parameter Options	
③	Output Status (Lit when O/P is ON)		
④	Time Range (Blink in online Mode)		
⑤	Operating Mode		

CONFIGURATION MODE

1. Enter by pressing the key 'M' for 3 sec.
2. Scroll the parameters by pressing the key 'S'
3. Change the parameter value by pressing the \blacktriangle / \blacktriangledown key.
4. Exit config. mode by pressing the key 'M' for 3sec. [All parameters are saved in memory when unit exits from config. mode.]

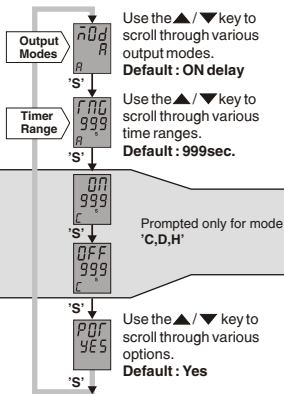

FRONT RESET

1. Enter by pressing the \blacktriangledown key for 5sec.
(* The unit will auto exit reset mode after 1sec.)



TIME SET MODE

1. Enter by pressing the key 'S' for 5 sec.
2. Press the key 'S' to select next digit.
3. If 'S' key is pressed when cursor is at the right most position [and the parameter being set is not the last one] the next parameter is displayed. And if it is the last parameter then it exits the time set mode and all parameters are stored in memory.

TIME SET MODE

1) If the mode is ON delay

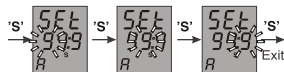

2) If the mode is C,D,H

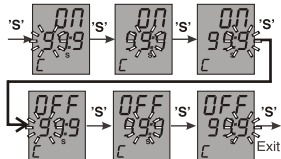

TERMINAL CONNECTION

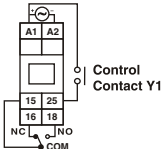

LOAD CONNECTION

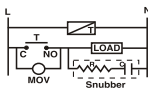

NOTE : 1) Snubber Part No.: APRC - 01.
2) MOV Part No.: AP-MOV - 03.
Use snubber to increase the life of relay.

MECHANICAL INSTALLATION

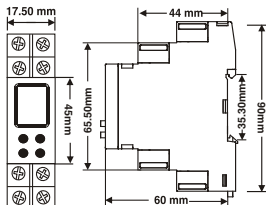

Outline dimensions (in mm)

MODE OF OPERATION

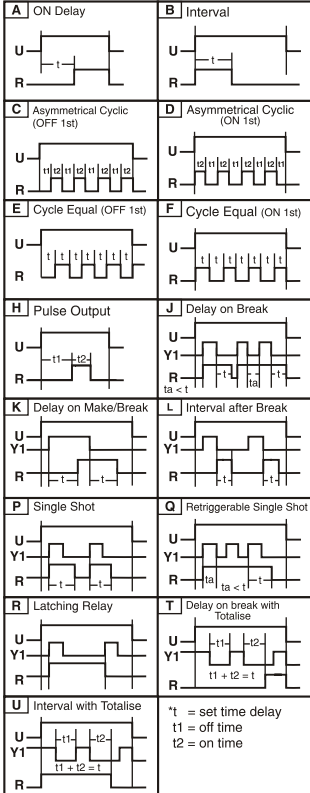

(Specifications are subject to change, since development is a continuous process)

Selec Controls Pvt. Ltd.

Tel. No. : +91-22-40394200 / 40394202

Fax No. : +91-22-284717331 | Toll free : 1800 227 353

Website: www.selec.com | Email: sales@selec.com