

**Vertical tail**

**Horn  
position**

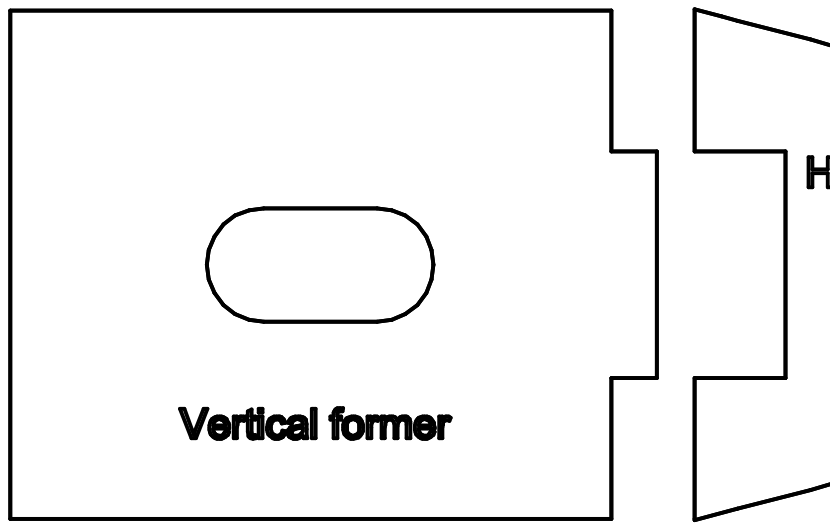

**Vertical former**

**H**

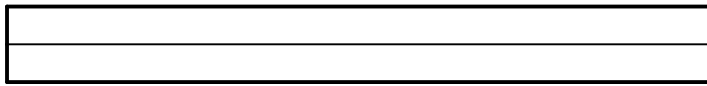

6mm d

al tail

on

**Horizontal former**

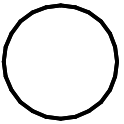

**Centre lower  
wing brace  
(rear)**

Pr

**6mm diameter carbon tube**

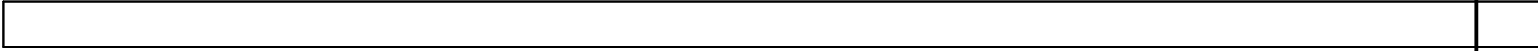

**Floats, make two sets of 5 each**

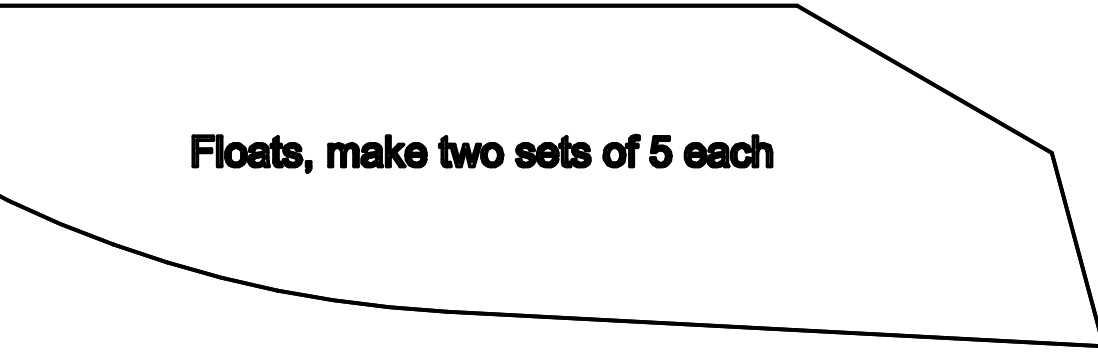

**4x1mm carbon**

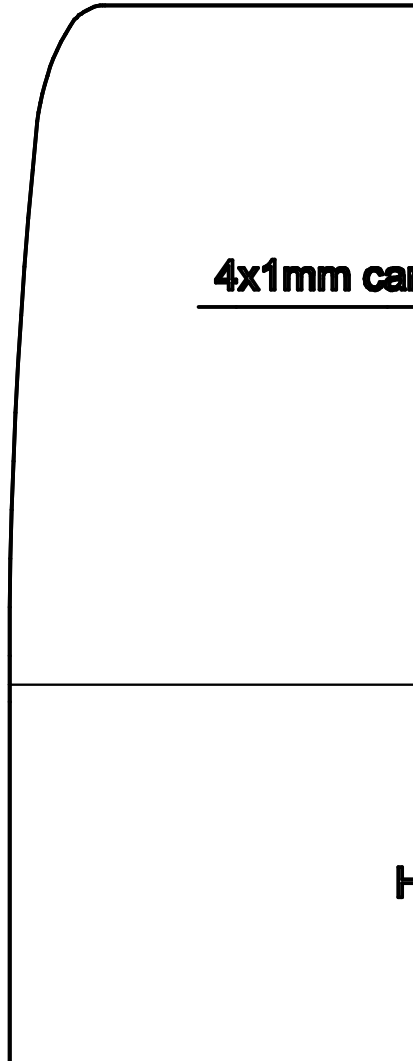
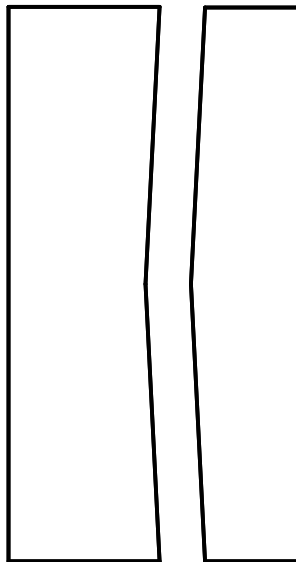
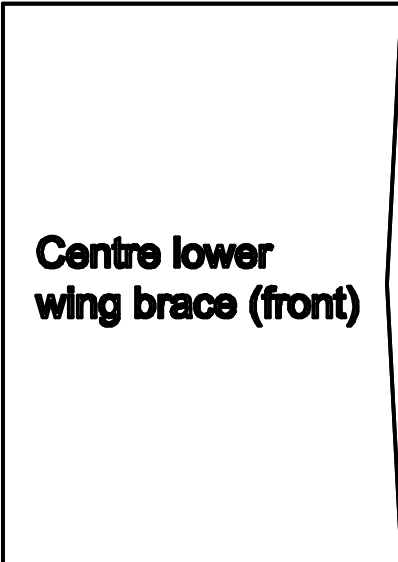

**Printing scale reference**

**700mm**

**Plywood doublers  
Make two of each**



**Float  
position**

**4x1mm carbon flat**

**Horizontal tail**

**Horn  
position**

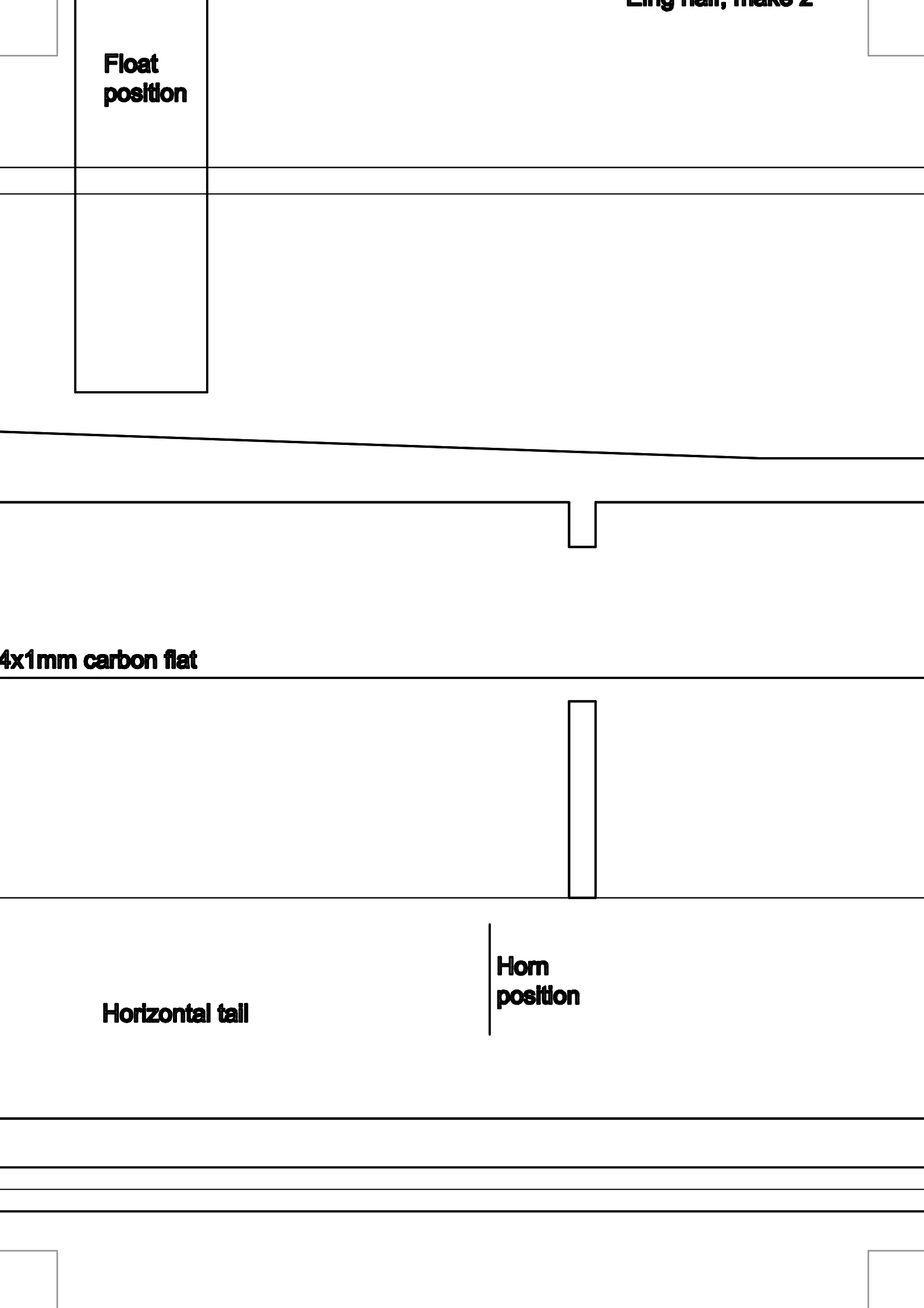

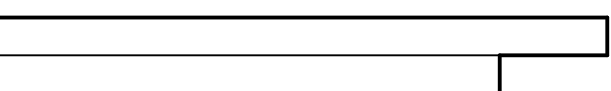
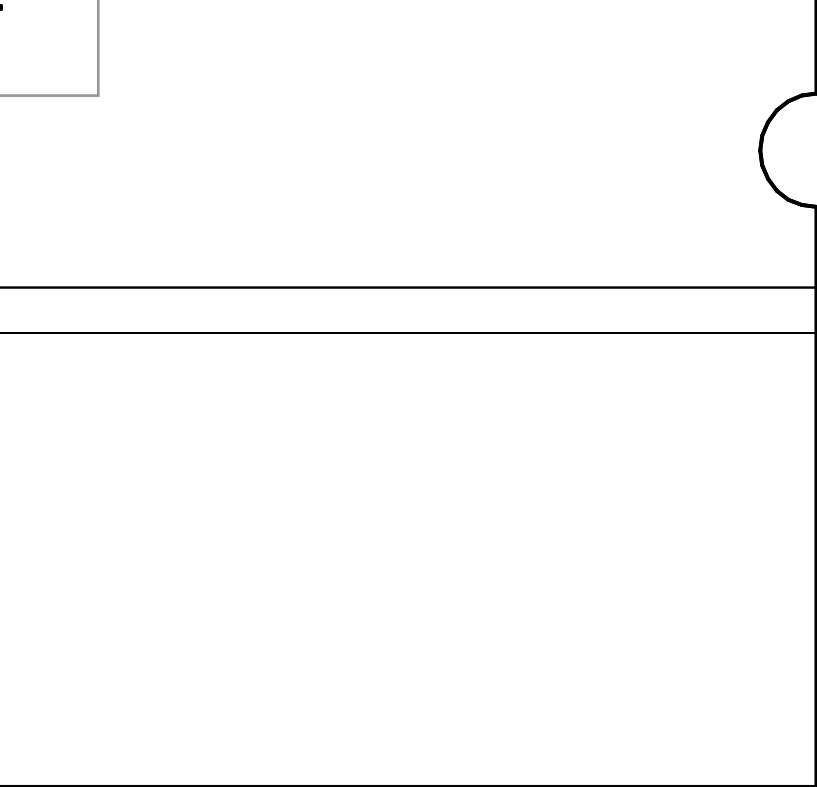

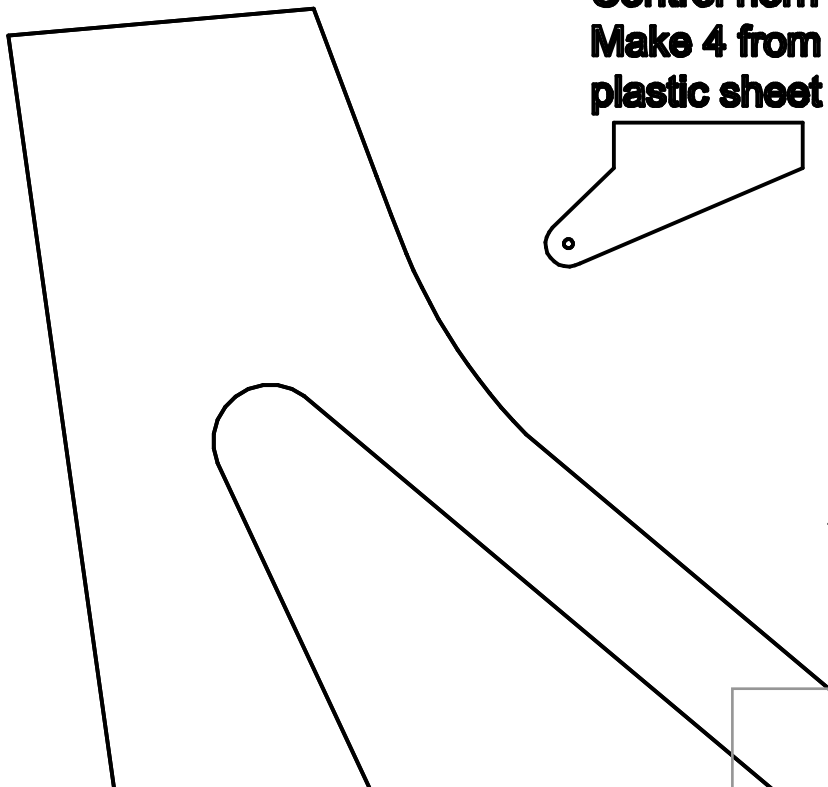
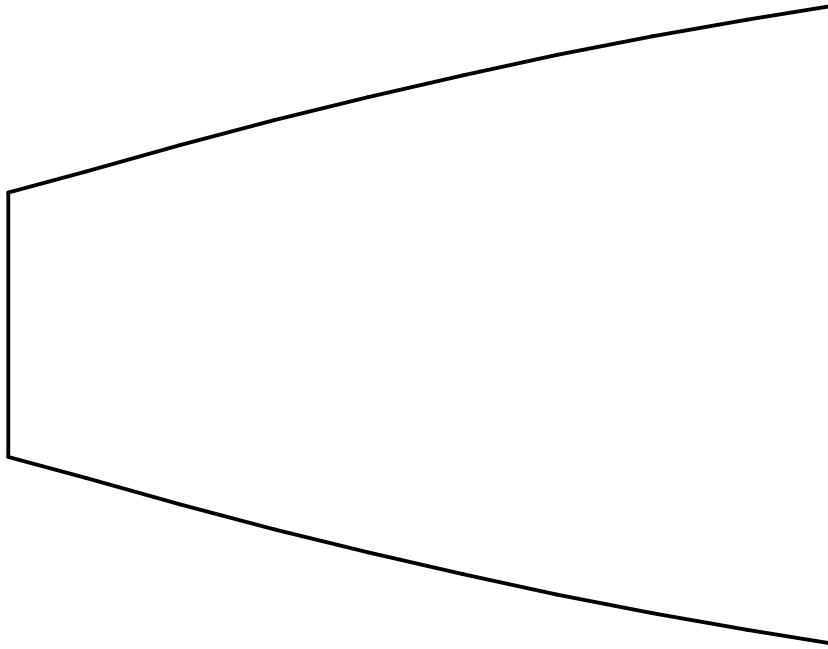
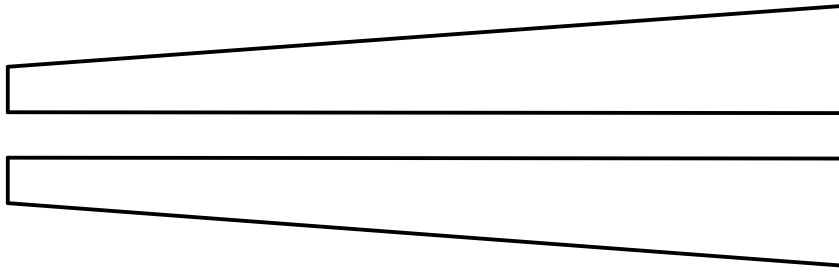

**Control horn  
Make 4 from  
plastic sheet**

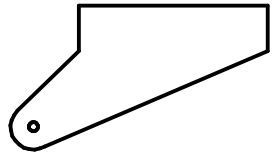

**Deck**

**Fuselage nose bottom**

**Control horn  
make 4 from  
plastic sheet**

**Size for  
servo**

**Tail sides, make 2**

**Size for servo,  
one side only**

**Deck**

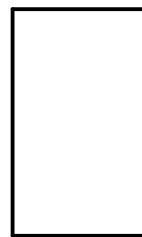
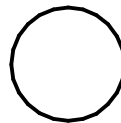

**Fuselage tail bottom**

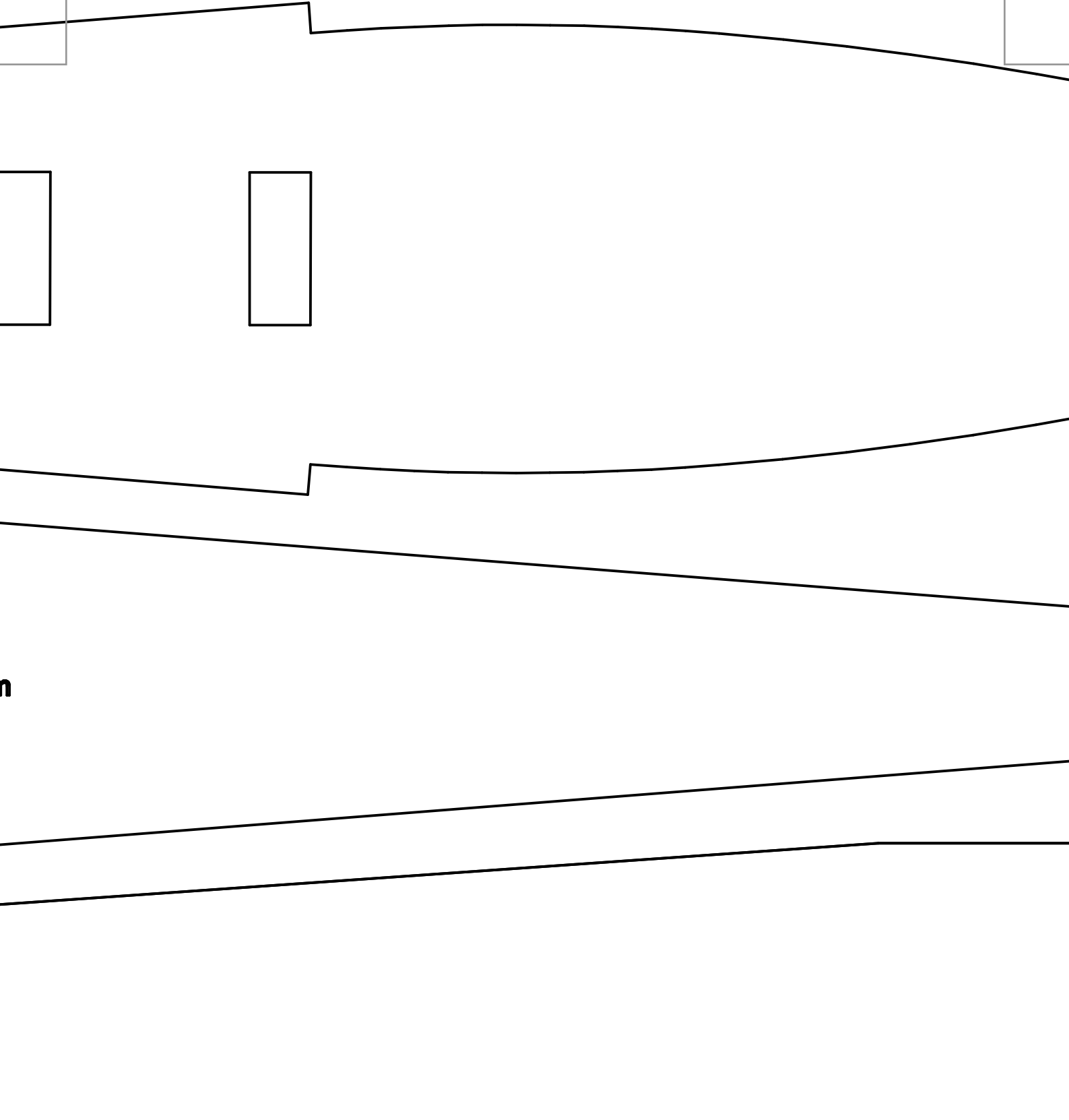

n

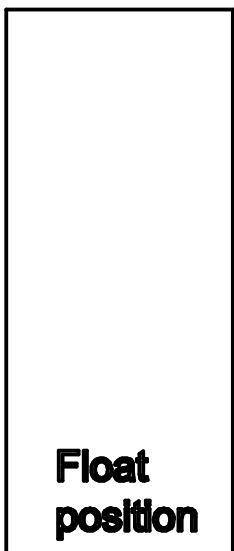

**Float  
position**

**Eing half, make 2**



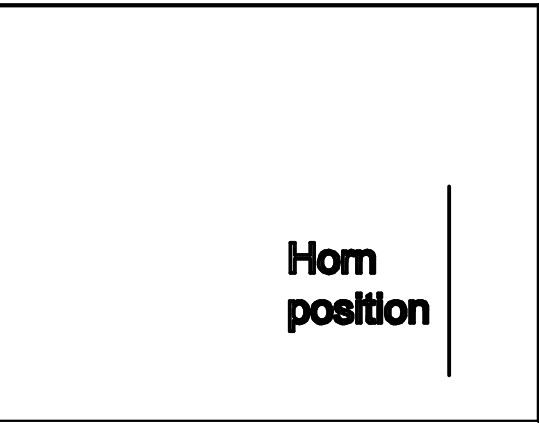
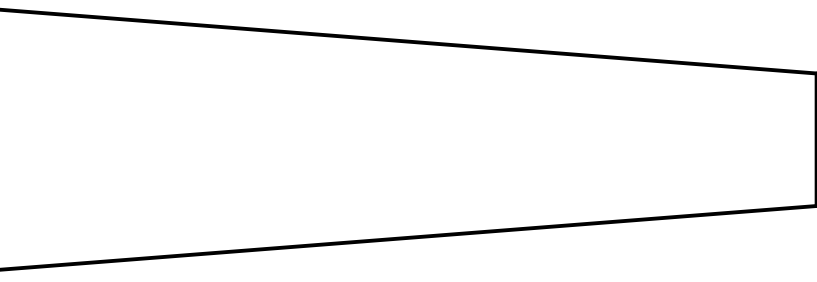
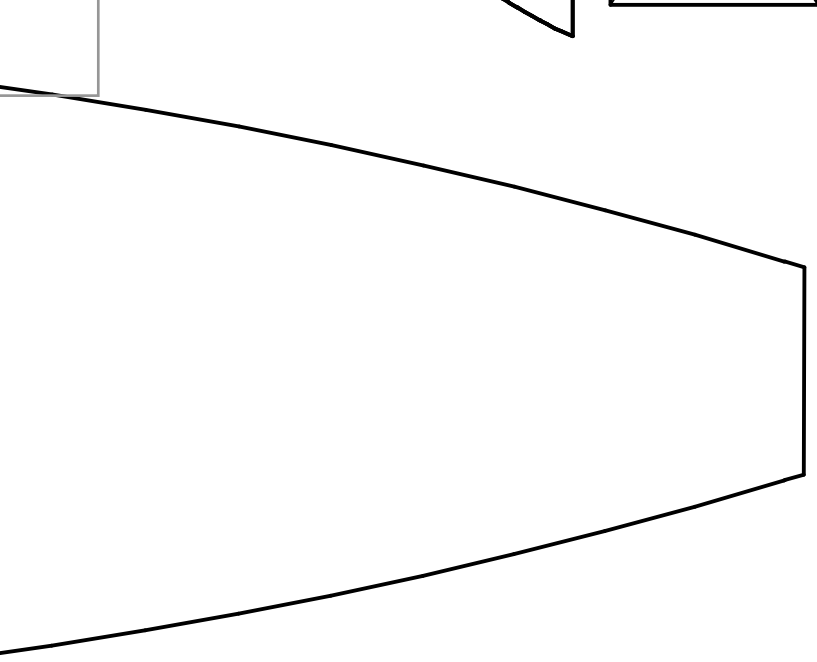

**Hom  
position**

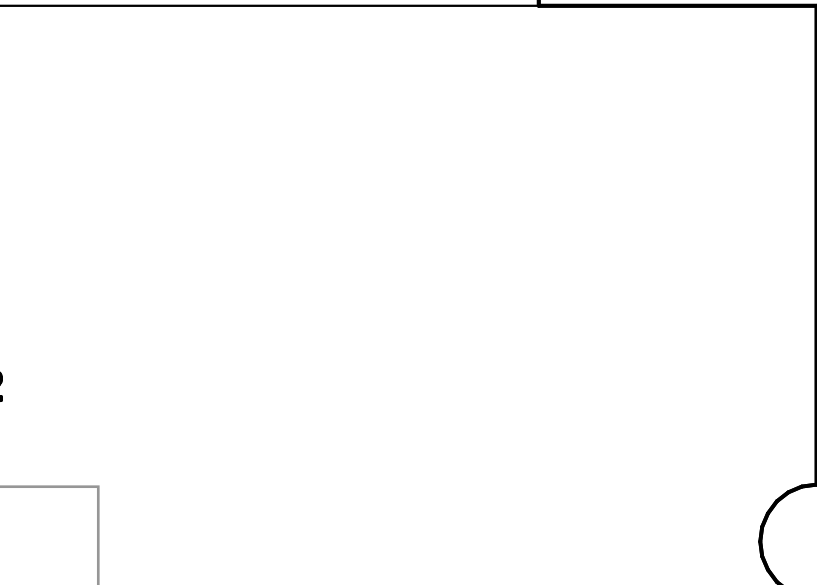



**Motor mount  
box top**



**Motor mount box side  
make 2**



**Mo**



**Rear wing brace  
Make 2 of each**

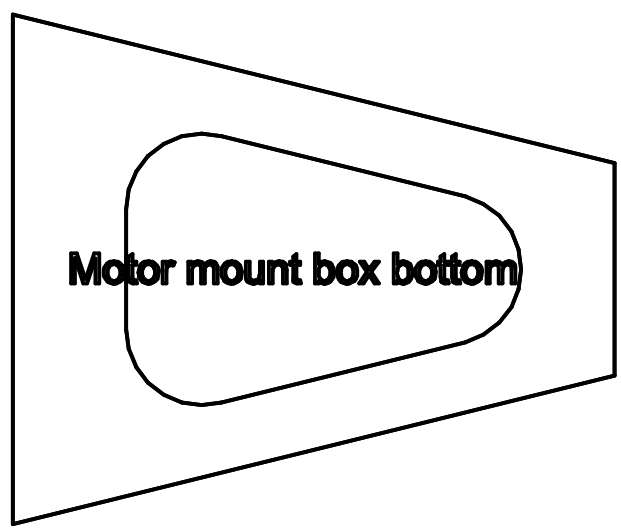
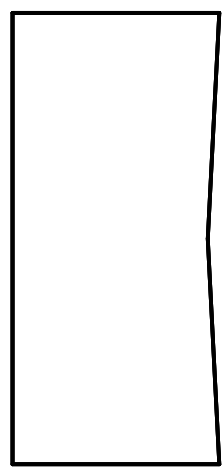

**Motor mount box bottom**

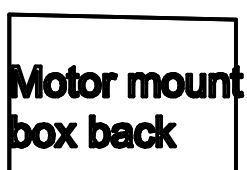

**Motor mount  
box back**

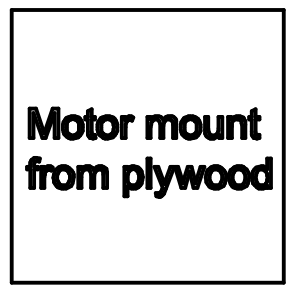

**Motor mount  
from plywood**

**Fuselage side, make 2**

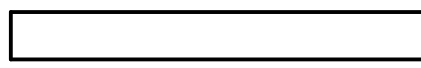
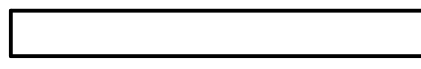

**Front wing braces**  
**Make 2 of each**

**Front wing braces**  
**Make 2 of each**

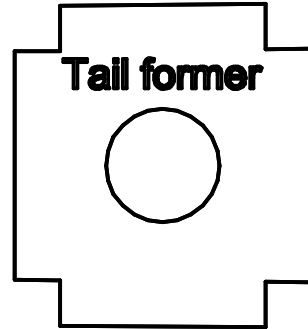
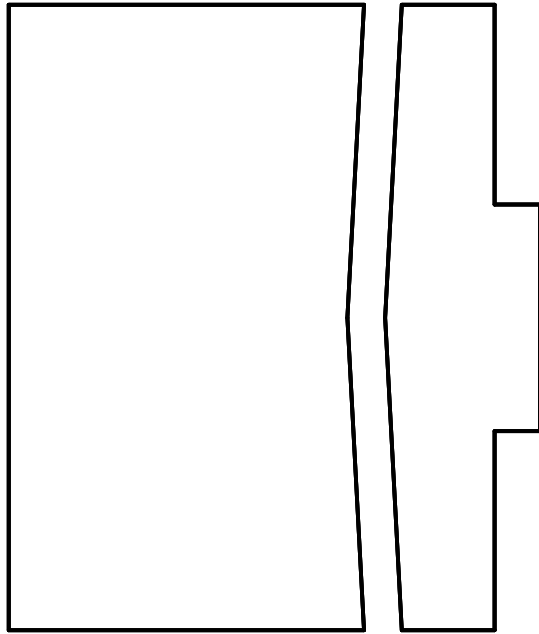
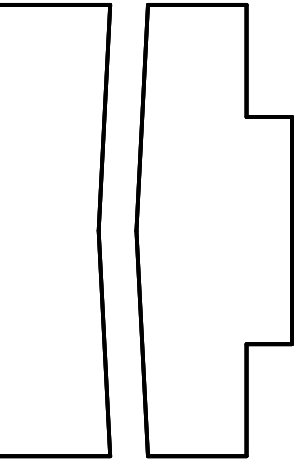

**Tail former**

M  
F

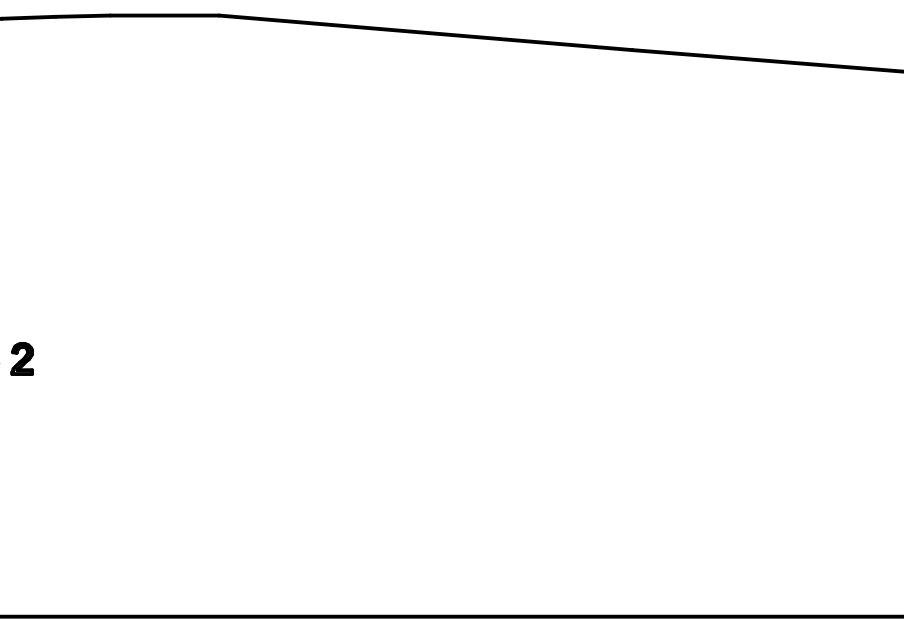

**2**

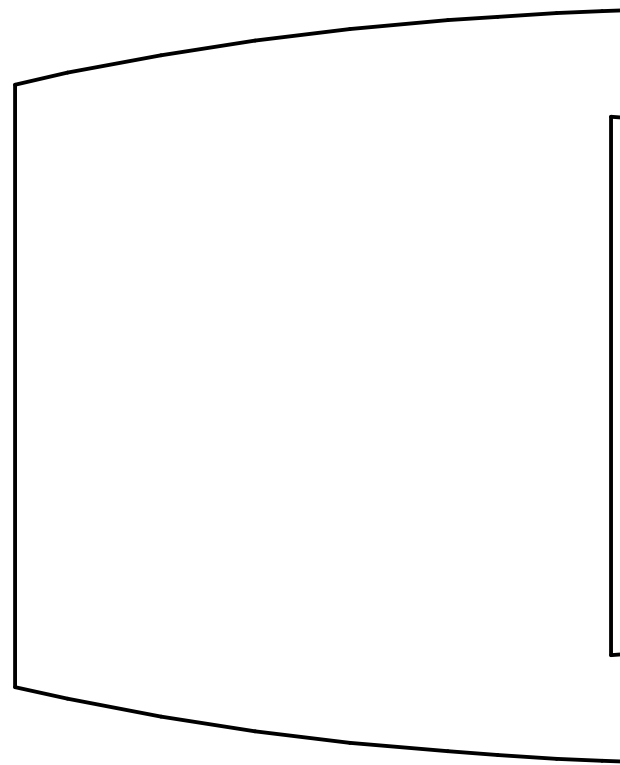

**Size for servo, cut out after assembly**

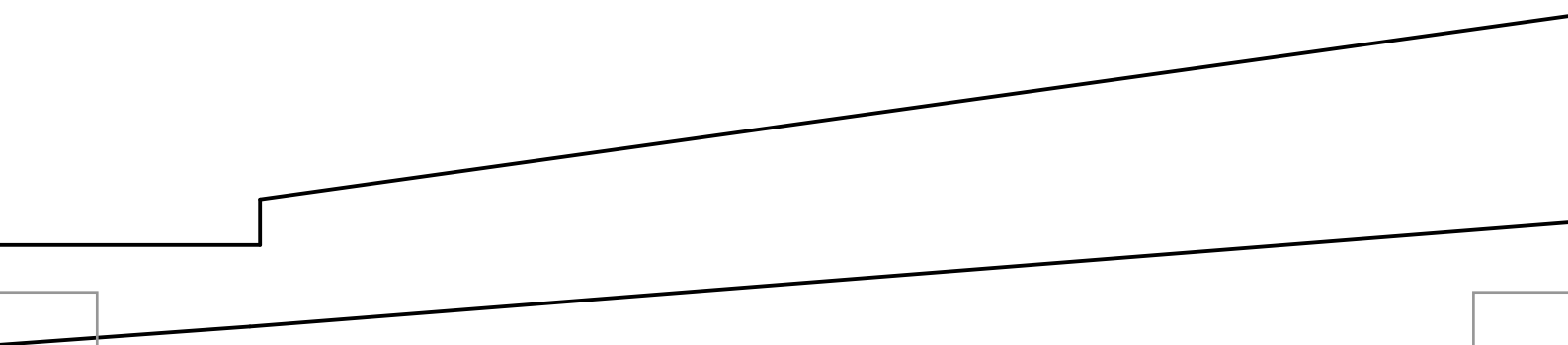
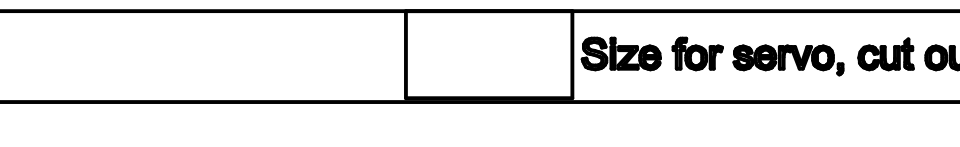

# MERMAID PARTS

Position this corner 15°  
forward of motor mou

Ce

Hatch, cut out after assembly

Fusela

**is corner 15mm  
motor mounting box**

**Canopy marking template**

**Fuselage top**

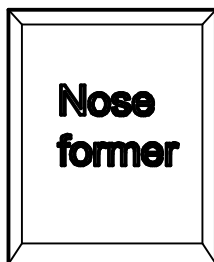





**Front wing braces**  
**Make 2 of each**







21

22

23

24

25

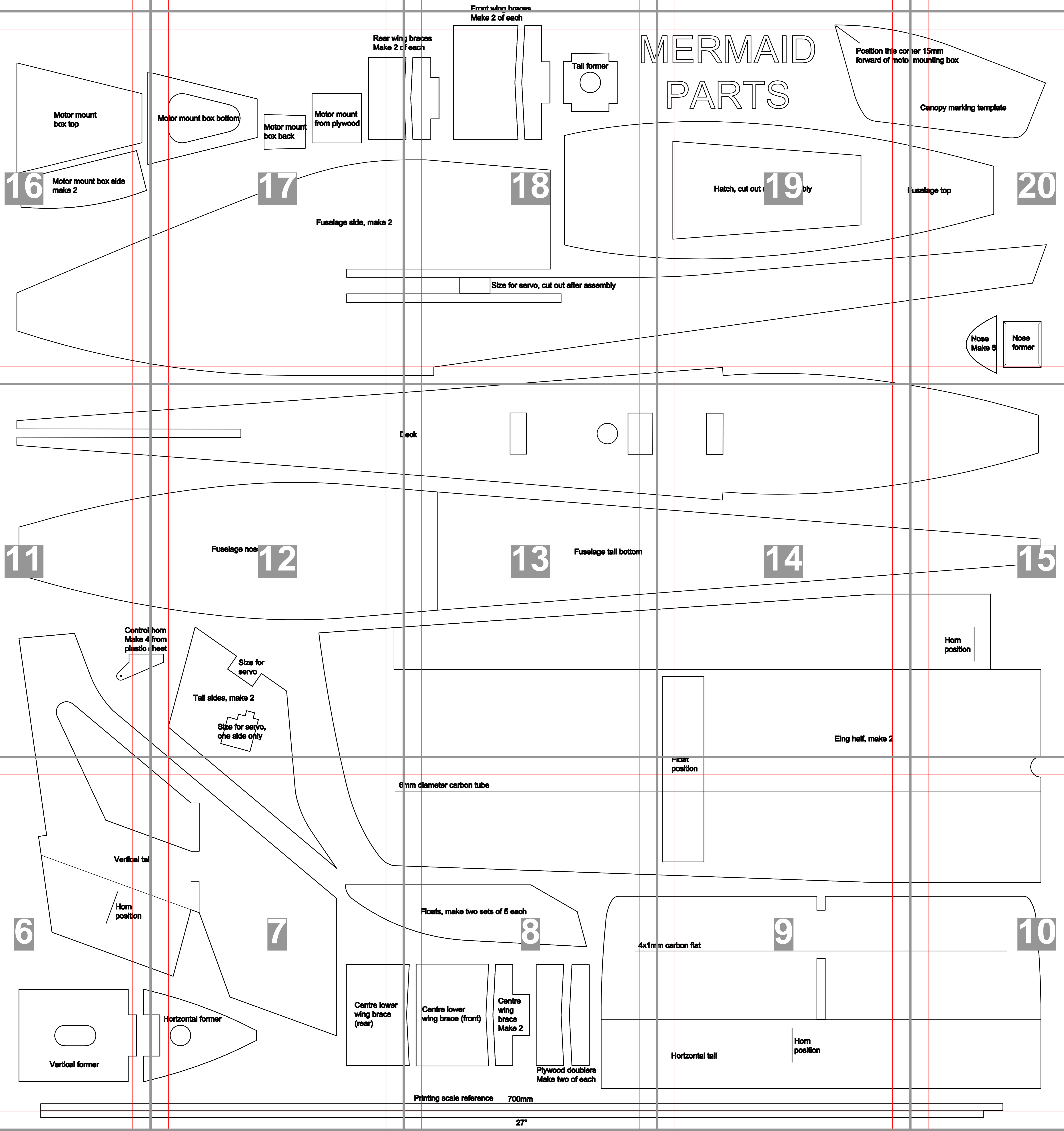

1

2

3

4

5