

### Power supply

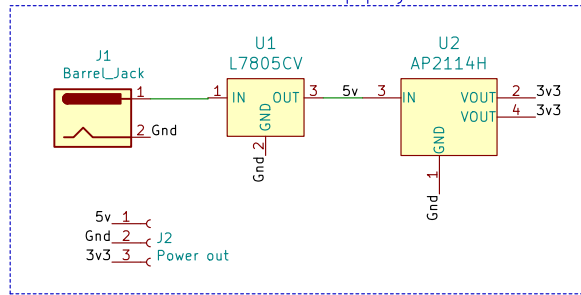

### ESP-32 I/O Ports

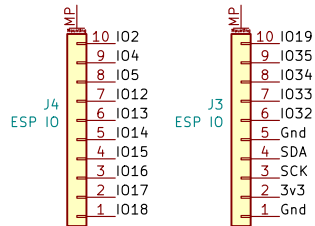

### ESP-32 UART Port

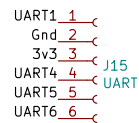

### MOD1 ESP32-WR00M-32

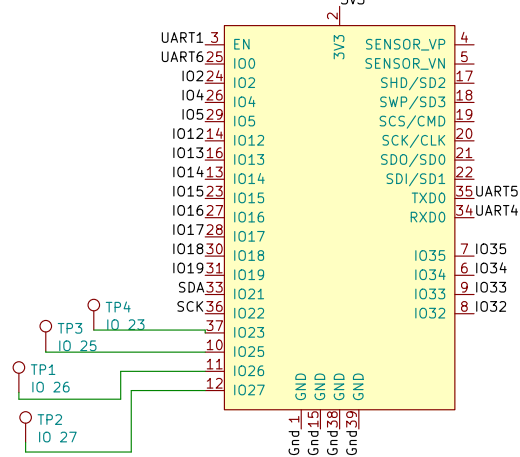

### MCP 1 I/O ports

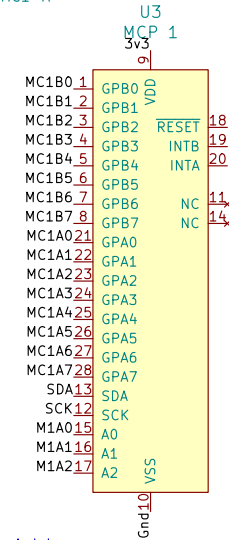
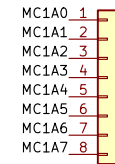
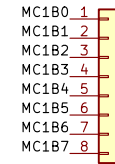

### MCP 1 Address

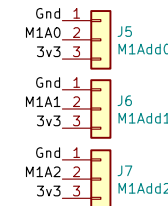

### MCP 2 I/O ports

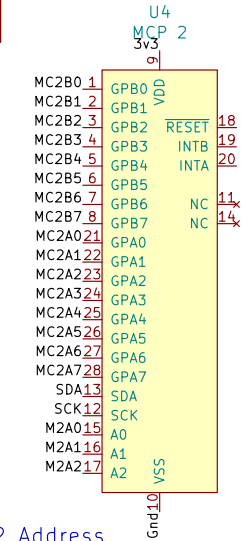
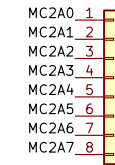
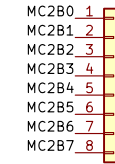

### MCP 2 Address

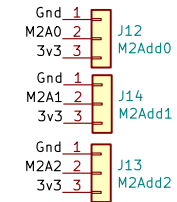

DWM "Sparky Circuits"

Sheet: /  
File: ESP MCP breakout.sch

### Title: Mega ESP-32

Size: A4 Date: 2/15/2020  
KiCad E.D.A. kicad (5.1.2)-2

Rev: A  
Id: 1/1