

From the makers of  
**CHASSIS SAVER™**  
Rust Preventive Truck & Auto Underbody Coating



# Roll-On Truck Bed & Utility Liner

## Installation Guide

Revised 7-10-12

See update on  
page 4 regarding  
tintable Monstaliner  
recoat times

- **Easy D.I.Y. Installation • Professional Results**
- **100% UV Permanent • Over 40 Dry Mills Thick**

**⚠ This product is intended for use in a well ventilated garage.**



- **Easy D.I.Y. Installation**
- **Professional Results**
- **100% UV Permanent**
- **Over 40 Dry Mills Thick**

MONSTALINER™ from Magnet Paints is a unique do-it-yourself coating designed for easy roller installation with no special skills or equipment needed to achieve professional results. Developed for pickup truck owners seeking a high performance alternative to expensive spray-in bed liners, Monstaliner is 100% UV Permanent and is guaranteed never to chalk, fade or discolor. Once installed, Monstaliner requires no maintenance and continues looking great without any topcoats, sealants or protectants.

## The complete MONSTALINER™ Do-It-Yourself Kit includes:

- |   |   |
|---|---|
| <input checked="" type="checkbox"/> 2 gallons bed liner coating | <input checked="" type="checkbox"/> 50 ft Low-tack masking tape   |
| <input checked="" type="checkbox"/> 2 pints extreme catalyst    | <input checked="" type="checkbox"/> 2 abrasive scuffing pads      |
| <input checked="" type="checkbox"/> 1 roller frame/handle       | <input checked="" type="checkbox"/> 8 solvent resistant gloves    |
| <input checked="" type="checkbox"/> 3 foam texture rollers      | <input checked="" type="checkbox"/> 2 wooden mix sticks           |
| <input checked="" type="checkbox"/> 1 paint brush               | <input checked="" type="checkbox"/> 1 drill bit mixing paddle     |
| <input checked="" type="checkbox"/> 2 disposable roller pans    | <input checked="" type="checkbox"/> 1 detailed installation guide |

### Additional supplies needed (not included):

- MEK solvent (1 quart)
- garden hose & spray nozzle
- power drill
- clean rags ○ broom
- scrap cardboard
- protective eye wear
- respirator mask (if working indoors)

### Optional supplies (not included):

- shop vac
- pressure washer
- knee pads
- wire brush
- grinder
- plastic drop cloth
- newspaper

**NOTICE: READ THIS COMPLETE BULLETIN BEFORE STARTING YOUR PROJECT — DO NOT OPEN CANS UNTIL SURFACE PREP IS COMPLETE AND YOU ARE READY TO MIX & APPLY COATING**

## General Handling & Usage Guidelines

**CAUTION: BEFORE YOU START!** It is very important that this product be used only in a well-ventilated area. When applying coating indoors (garage, warehouse, etc.), prevent vapor build-up by opening all windows and doors to achieve cross-ventilation or use other means to ensure positive fresh air entry during application and drying. If good ventilation is not possible, wear an appropriate properly fitted respirator (NIOSH/MSHA TC23C or equivalent) while exposed. Follow respirator manufacturer's directions for respirator use.

**INDIVIDUALS WITH HISTORY OF LUNG OR BREATHING PROBLEMS OR PRIOR REACTION TO ISOCYANATES SHOULD NOT USE OR BE EXPOSED TO THIS PRODUCT.**

**Do not permit anyone without protection in the painting area.**

**NOTICE:** Reports have associated repeated and prolonged occupational overexposure to solvents with permanent brain and nervous system damage. Eye watering, headaches, nausea, dizziness and loss of coordination are signs that solvent levels are too high. Intentional misuse by deliberately concentrating and inhaling the contents can be harmful or fatal.

- Always wear protective gloves (provided) and protective eyewear while preparing, mixing and applying coating. Keep away from heat, sparks and flame. Turn off stoves, heaters and other sources of ignition during use and until all vapors are gone. Do not operate vehicle while preparing, mixing and applying Monstaliner Truck Bed Liner. Do not smoke while using this or any solvent containing coating.

- If working outdoors, avoid coating in windy conditions to prevent leaves, bugs and debris from blowing into wet coating. If temporary indoor space is available, apply coating outdoors and move vehicle indoors to dry.

- Mix coating (Part A) before use and blend thoroughly with the catalyst component (Part B) only at the time of use. Scrape sides and bottom of can well during mixing to ensure uniformity and complete incorporation of catalyst. Once Part A and Part B have been mixed, coating remains usable for 6 to 10 hours depending on temp and humidity. **(See Steps 8 & 9)**

- Never add thinners or reducers to Monstaliner.

- Store coating components at room temperature for 12 hours before use.

- Do not apply in the rain. If rain is forecasted, park vehicle indoors and keep vehicle dry prior to surface preparation and coating installation. After coating installation, do not expose to rain for a minimum of 12 hours.

- If working in an unheated garage or warehouse space, do not apply if temperature is expected to drop below 50°F. After the coating had been installed, do not expose to temperatures below 50°F for the first 12 hours after application.

## Tips & Techniques For Correct Results & Texture Appearance

► MONSTALINER™ has a unique surface texture created exclusively by the installation rollers. Texture is pulled from the wet coating by the roller and cures as a raised, uniform surface. It takes 2 full coats to complete the texture effect and final appearance is only visible after the second coat.

► For correct results, use only the rollers provided in the kit. Pour coating into supplied roller pans. Load roller with as much liquid as it will hold and roll slowly and evenly until roller feels like it needs more material but is not dry. Apply coating generously using a firm, medium pressure while rolling. Avoid spreading coating too thin before re-loading roller. Finish up each area rolling in one direction only. See caution below. 



**Treat foam rollers carefully to avoid damage to the foam. Avoid rolling aggressively against sharp corners or edges in the bed. Excessive pressure applied to the roller can cause foam pieces to break free and get mixed with the coating. If this should occur, carefully pick out pieces of broken foam and replace roller before continuing. Inspect roller often for damage or loose foam.**

- Be careful not to apply too much coating in one area, especially on vertical surfaces which can cause running/sagging. Stop often to inspect for runs, drips or puddles.
- Monstaliner Truck Bed & Utility Liner is formulated using a high performance, UV permanent, dual cure urethane polymer system. Over 4 years of extensive laboratory testing and field evaluations have proven Monstaliner to outlast and outperform all other do-it-yourself coatings compared. Unlike epoxies and UV sensitive urethanes, Monstaliner will never chalk, fade or discolor and requires no additional surface protection, dressings or topcoats to maintain or restore its appearance.
- Cleaning your new Monstaliner truck bed is as easy as sweeping and hosing out dirt and debris. With minimal care, Monstaliner will look great for many years.

## Surface Preparation & Installation

### 1) SURFACE PREPARATION - CLEANING TRUCK BED:

- Sweep or vacuum out debris from truck bed.
- Wire brush, sand or grind any lightly rusted areas to completely remove any loose, bubbling or flaking rust and paint. (*See Step 5 for heavy rust*)
- Power wash or scrub truck bed and tailgate surfaces using a household detergent or TSP (Trisodium Phosphate) and hot water. Be sure to thoroughly remove all dirt including oil spots and any petroleum products residue. Rinse surfaces well and allow to dry thoroughly.
- Remove tailgate (optional but highly recommended) and place on a stable work surface that won't scratch your paint.
- Remove any tailgate or tiedown hardware if it's in an area that you are going to coat.

### 2) SOLVENT WIPE/WAX REMOVAL: IMPORTANT! Solvents are flammable. Make sure you are working in a well-ventilated area, are wearing protective equipment and have read all cautionary information and procedures described on the labels or material safety data sheet of the solvents being used.

- Saturate a clean rag with MEK Solvent and wipe down all bed and tailgate surfaces that will be coated. Periodically rotate and replace rags and always use a clean section of the cloth.
- Give special attention to waxed areas; be sure to remove all wax. Monstaliner will not adhere to waxy surfaces.

### 3) DEGLOSSING & ROUGHING UP SURFACE:

- Using the supplied coarse scuffing pads, scour the entire area that will be coated. Proper surface preparation is evidenced by removal of gloss and generation of a light powder on the surface. 120 to 180 grit sandpaper may also be used if desired.
- Sweep or vacuum out all sanding dust and debris.

### 4) FINAL SOLVENT WIPE:

- Repeat the solvent wipe to remove any remaining fine dust or debris and to clean any oils from your hands touching the bed.

### 5) TREATING RUSTED AREAS (Optional):

- If your bed has minor rusted areas, Monstaliner can be applied directly over rust. Proceed with taping/masking in Step 6. If extensive rust is present, it is advisable to first coat these areas using Magnet Chassis Saver #934 Aluminum Rust Preventive Truck & Auto Underbody Coating. Apply 2 coats of #934 and allow to dry overnight before applying Monstaliner. Contact your dealer or Magnet Paints technical services with rust related questions or for further information.

### 6) TAPING/MASKING:

- Mask off all areas that will not be coated. Take your time to plan where you will end the coating. The neater your taping job, the nicer your final results. Look at other trucks with bed liners to get ideas. Drape newspaper and/or plastic over adjacent surfaces to prevent coating splash or roller spatter.
- Cover any open drain plugs and/or latch bolts with tape.

### 7) APPLYING BED LINER:

- **PROTECT YOUR SKIN!** Wear supplied gloves, painting clothes and protective eye wear. Skin contact is not harmful but should be avoided. Product may stain skin or take time to remove.
- **IMPORTANT! Never coat the bed of a vehicle that has been sitting in the sun. Surfaces must be at ambient temperature or cool to the touch. Park vehicle indoors or in a shaded area prior to coating and allow surfaces to cool. A hot bed surface will cause solvents to flash off (evaporate) too quickly making application difficult.**

**DO NOT BEGIN COATING THE BED FLOOR UNTIL YOU HAVE COMPLETED AT LEAST ONE COAT ALL AROUND THE SIDE WALLS.**

- **IMPORTANT! Monstaliner cures by reacting with atmospheric moisture. While the risk of spoiling an opened can during use is minimal, a few handling precautions should be observed. While working on your truck bed, you will periodically pour more coating into the roller pan. Be sure to place the lid loosely back on the can after pouring each time. This will minimize the normal thickening that occurs by the materials exposure to moisture. If you are working on a hot day and beads of sweat form on your forehead, be careful not to drip sweat in the open can as any added moisture will accelerate the curing process in the can.**

## Coating Application - 1st Coat

### 8) MIXING CATALYST WITH BED LINER:

- Shake your first gallon of Monstaliner (Part A) vigorously for 30 seconds. Gently pry the lid off the can. Contents may be under slight pressure. Note that can is short filled to allow the addition of (Part B) catalyst. Shake catalyst vigorously for 10 seconds. Open catalyst and dump entire contents into the part filled can of Monstaliner. Scrape excess catalyst from can using supplied wooden mixing stick. Attach supplied drill bit mixing paddle to your drill and power mix components for 3 full minutes. While power mixing, stop periodically and scrape sides and bottom of can using wooden stick. Shake excess liquid from drill mixing paddle and store for later use. To mix less than 1 full gallon, carefully measure 7 parts bed liner to 1 part catalyst by volume.

### 9) MIXED POT LIFE:

- Pot life of mixed material is 6 to 10 hours depending on temperature and humidity.

### 10) STARTING TO COAT:

- Pour a small amount of coating into one of the supplied roller trays. Using the supplied paint brush; begin coating all corners, seams and hard-to-reach areas. Dab Monstaliner on rather than brushing it like paint.
- When all corners, seams and hard-to-reach areas have been covered (cut-in), begin rolling your first coat onto the side walls of the bed. (*See Figure 1*) Roll coating generously. Do not spread too thin.
- Pour additional liquid into tray as needed and load roller with as much material as it will hold. Roll slowly and evenly using firm, medium pressure on the roller. Continue rolling until the roller needs more material but is not empty or dry. Finish up each side wall area rolling in one direction only.



**NEVER USE LACQUER THINNER OR ALCOHOLS ON SURFACES TO BE COATED**

## Surface Preparation & Installation (continued)

**HELPFUL HINT:** When coating the side walls of the bed, it is sometimes easier to stand outside the truck on a short step stool and reach into the bed with the roller. Leave your roller pan inside the bed on a piece of scrap cardboard.

- When side walls are complete, begin rolling the floor of the bed. (See Figure 2)

- Refill roller pan as needed. Apply coating generously. Roll first in the direction of the ribs then across ribs to even out the coating. (See Figure 3) Continue to spread until heavy spots are even and no puddles remain. Finish rolling with the direction of the ribs while angling roller into the grooves. (See Figure 4) Step back occasionally to look for uneven or heavy spots that may need further rolling. Complete first coat on tailgate as the last step.

- Using a glove or rag, carefully pull used roller cover off frame and discard. (Do not whack roller handle to remove refill) Discard used roller pan. Clean paint brush with a small amount of MEK solvent. Store brush for later use.

### DRY TIME TO RECOAT:

Coating must be dry to touch with little or no tack under your fingers.

UNDER NORMAL CONDITIONS – 50 to 60% Relative Humidity and 70 to 75°F – **FIRST COAT OF BLACK WILL DRY TO RECOAT IN 3 to 5 HOURS** – Warmer temperature and higher humidity will speed dry (shorten recoat time to as little as 1.5 to 2 hours). Colder temp and low humidity will slow dry (lengthen recoat time). 1st coat of **BLACK Monstaliner** may also be left to dry overnight as long as 2nd coat is installed within 24 hours. **FIRST COAT OF TINTABLE WILL DRY TO RECOAT IN 2 to 4 HOURS (in as little as 1 to 2 hours in high heat)** **NOTE: Tintable Monstaliner must be recoated within 8 hours or individual coating layers will not adhere properly to each other. If tintable coating cures for more than 8 hours before next coat is applied, leave it to dry for 24 hours and then lightly scuff surface using brown scuff pad, 220 grit sandpaper or fine Scotchbrite pad. Scuffing should dull surface and create a very small amount of dust. (Scuff lightly, not aggressively!) Remove scuffing dust with a water dampened sponge and allow to dry thoroughly before installation of next coat.**

## Coating Application - 2nd Coat

- Confirm that coating is dry for recoat. Since surface may not yet be walkable, apply 2nd coat by leaning into bed over sides of truck. A short screw tip roller extension pole may be helpful.

- Slide new roller cover onto roller frame and mix catalyst into your second gallon of Monstaliner coating.

- Repeat rolling process beginning with the side walls and then with the floor and tailgate. Apply coating generously. Final texture is created by finish rolling slowly, in one direction, using firm pressure. Try to use all remaining coating on the floor of the bed.

### 11) CLEAN-UP/TAPE REMOVAL:

- After 2nd coat is complete, immediately remove all masking tape, pulling slowly at a 90 degree angle to surfaces to avoid disturbing the edges of the coating. Handle with care when removing; tape may have wet coating sticking to it. The earlier the tape is removed, the cleaner your tape lines will be and tape will come off easier.

- If any coating gets on painted surfaces of vehicle, remove promptly using a small amount of MEK on a clean rag. Re-wax areas wiped with solvent.

### 12) PLACING TRUCK BED BACK IN SERVICE:

- Spray a light water mist over coated surfaces 8 to 10 hours after final coat is installed.
- Allow 24 to 48 hours after coating has dried for light duty use. Do not throw or drag heavy or sharp items in truck bed until coating has fully cured which will take 7 days.

**Figure 1**  
Start here and coat side walls first

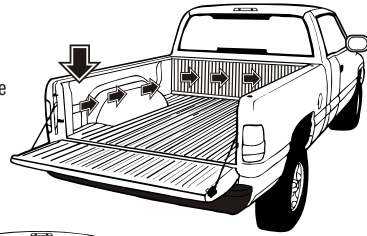

**Figure 2**  
Coat bed surface from front area towards rear

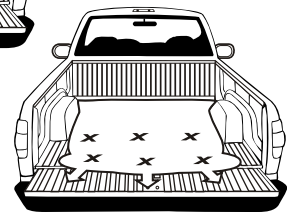
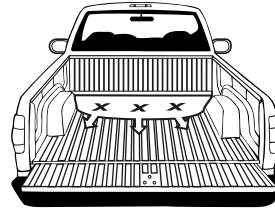

**Figure 3**  
Roll across ribs first to spread material

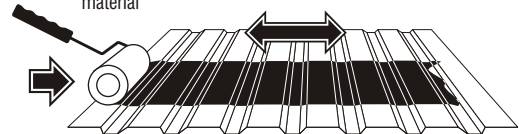

**Figure 4**  
Roll with ribs, angle roller, finish in one direction

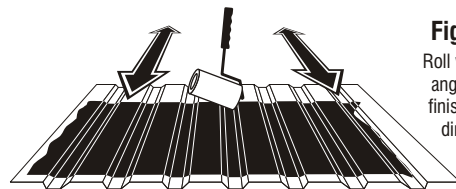

## Spray Installation

MONSTALINER™ can be sprayed using a simple “Shutz” style undercoating gun and a compressed air source. By regulating pressure between 50 and 100 PSI at the gun, a variety of surface textures can be achieved. Prepare surfaces as per previous instructions. Reduce coating with 4oz of MEK or Acetone per catalyzed gallon. Spray 2 to 3 light - medium wet coats allowing 1 hour cure time between coats.

For any questions, comments or assistance before using, call Magnet Paints Technical Services, Mon - Fri from 9AM to 4PM EST at 1.800.922.9981 or send an email to [info@magnetpaints.com](mailto:info@magnetpaints.com)

**NBS**  
High Performance Coatings

**MAGNET PAINTS**  
336 Bayview Avenue • Amityville, NY 11701 • 631-842-7700  
[www.magnetpaints.com](http://www.magnetpaints.com)

# HOT WEATHER HANDLING NOTES

Depending on temperature, recoat times may be shortened to as little as 1.0 - 1.5 hours. Between coats, use a small scrap of cardboard to scrape down the inside walls of the can so that no heavy buildup remains. To prevent skinning over of catalyzed material in the can, pour a small amount of your cleaning solvent (MEK, Acetone or MEK Substitute) over the surface of the remaining coating. **Use only a few ounces of solvent so you can see a shallow puddle.** When beginning your second coat, mix the solvent into the coating and proceed with application. **IMPORTANT:** 1 gallon kits do not include a roller pan - When purchasing this item at paint stores get only a narrow roller pan.

## MONSTALINER™ 1 Gallon Kit Directions (Black)

*(Supplement to 4 Page Installation Guide)*

If you've purchased a 1 gallon kit for a jeep tub or small project, the standard 4 page installation guide still applies except that you will only be mixing 1 full gallon and working within a 10 hour pot life to complete 2 coats from the same can. When you begin your 2nd coat, the remaining mixed/catalyzed material in the can will be slightly thicker than when you started but will still be 100% usable. If desired, a small amount of MEK solvent (2 to 3 ounces) may be mixed with remaining coating to facilitate easier rolling and gain additional coverage. Do not over-thin. You can always add more but not take it out.

If working in cold temperatures (40 to 50 deg F), the coating will take longer to dry (5 to 6 hours) before recoat is possible. **Avoid application of your 2<sup>nd</sup> coat if the coating is still sticky. Recoat should only proceed when the surface of your 1<sup>st</sup> coat is getting firm to touch with only a very slight or no tack when pressed lightly with your fingertips.** If possible, apply coating in heated garage or use a space heater to raise air temperature prior to application.

**AVOID WASTING THE COATING:** Do not pour too much material into your roller tray at one time. When nearing the end of your first coat, pour only small amounts of coating into tray as you will need to conserve as much as possible for your 2<sup>nd</sup> coat. Keep the lid on the can when not adding more to the tray. (You don't need to slam the lid down – just sit it on the can to keep air out). Close can tightly between coats.

### Tips for a Superior Job:

- Don't rush! Roll Slowly!
- If you are tired after surface prep just wait until the next day to install the coating.
- Avoid application of coating on rainy days or if humidity is above 80%.
- Work with good lighting (Very important)
- Keep coating materials indoors for 24 hours @ 70 deg F before use
- Mix gallon well before adding catalyst.
- Scrape all catalyst from the pint can into the gallon can.
- Mix components very well with drill mix blade (5 minutes)

Treat foam rollers with care. When rolling out the first coat, stress on the roller is the greatest. Be cautious of any sharp edges in the vehicle that could tear the foam.

Inspect the wet first coat carefully and pick out any small pieces of foam that may have broken off the roller. There will be less stress on the roller during the second coat but the same precautions should apply.

Work the roller with gentle force during the 2nd coat to see the texture created. Roll slowly.

Look over the wet job carefully and frequently from different angles to find any heavy spots that should be evened out with the roller. Also look for any debris that can be picked out.

**Use all the material.**

[www.monstaliner.com](http://www.monstaliner.com)

# Mixing MONSTASHADES™ with Tintable MONSTALINER™

(Clean 2 gallon plastic pail required)



## Mix color with Tintable MONSTALINER™

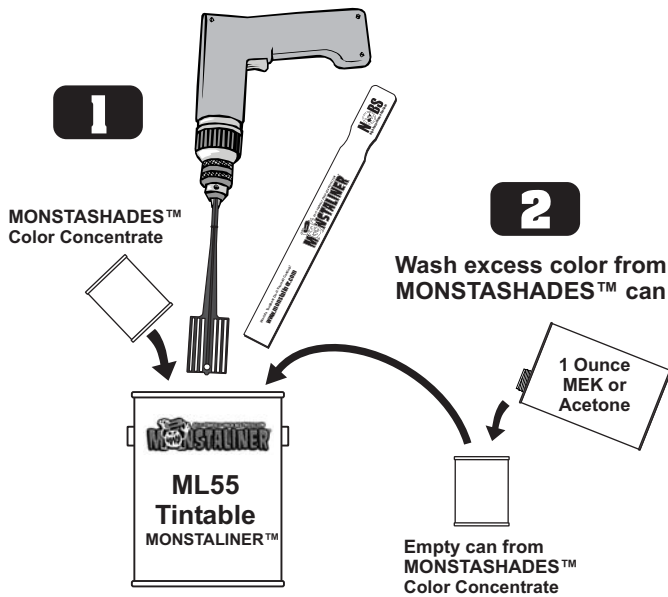

**Power mix contents of tintable coating for 3 full minutes before adding color.** Dump Monstashades Color Concentrate into gallon and add 1 oz (2 tablespoons) of MEK or Acetone to the empty color can. Seal can and shake before dumping wash liquid into gallon. Power mix gallon with color for 4 to 5 minutes stopping at least 2 times to scrape sides and bottom of can with wooden mix stick.

## Mix tinted coating together with Extreme Performance Catalyst in a clean 2 gallon plastic pail

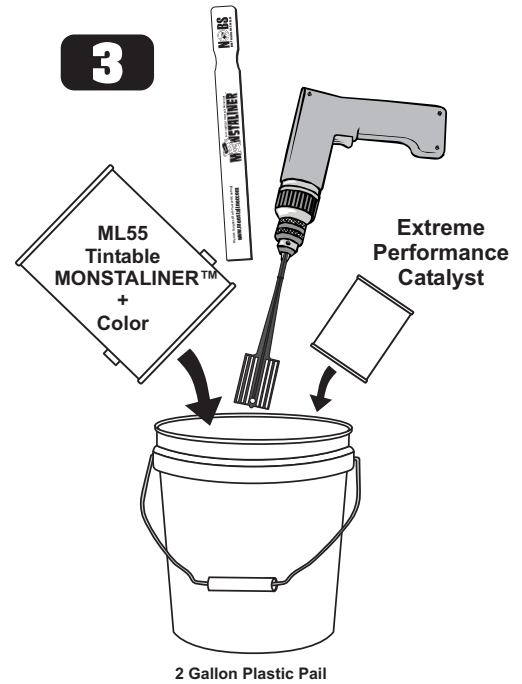

- Dump contents of color mixed gallon into a clean 2 gallon plastic pail and scrape remaining material from gallon into pail.
- Shake Catalyst for 30 seconds and pour contents into color mixed material. Scrape remaining material from catalyst can.
- Power mix catalyst into Monstalinier/Monstashades mixture for 4 full minutes stopping occasionally to scrape container sides and bottom.

**Pour mixed components back into original gallon can and stop ½ inch from top. Close lid tight.**

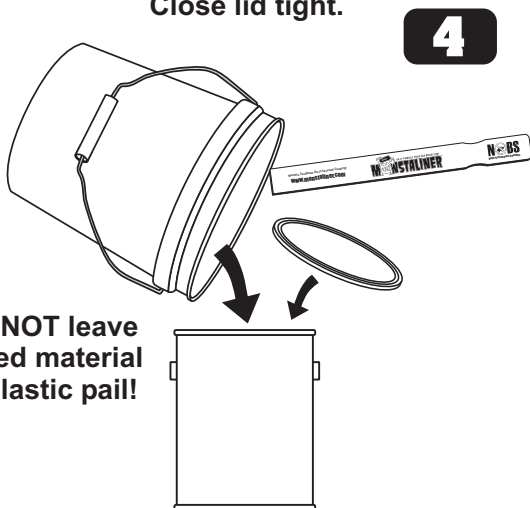

**DO NOT leave mixed material in plastic pail!**

**Use extra coating in mixing pail to start brushing corners & edges of your project then reopen gallon can to continue by pouring into roller pan**

During installation of Colored Monstalinier, initial re-thickening will occur as a result of viscosity control agents used to create texture. This is normal and re-power mixing at any time in the first few hours will thin down material.

**Never work directly from an open can.** Pour sparingly into the roller pan. When first coat is complete pour 2 - 3 oz (4 - 6 tablespoons) of MEK or Acetone over surface of remaining coating in can. Seal lid tightly. Re-power mix when beginning 2nd coat.

