

LEGO DIGITAL DESIGNER 4.2

Model Name:
Lego Technic Bowling machine

Number of Bricks: **709**

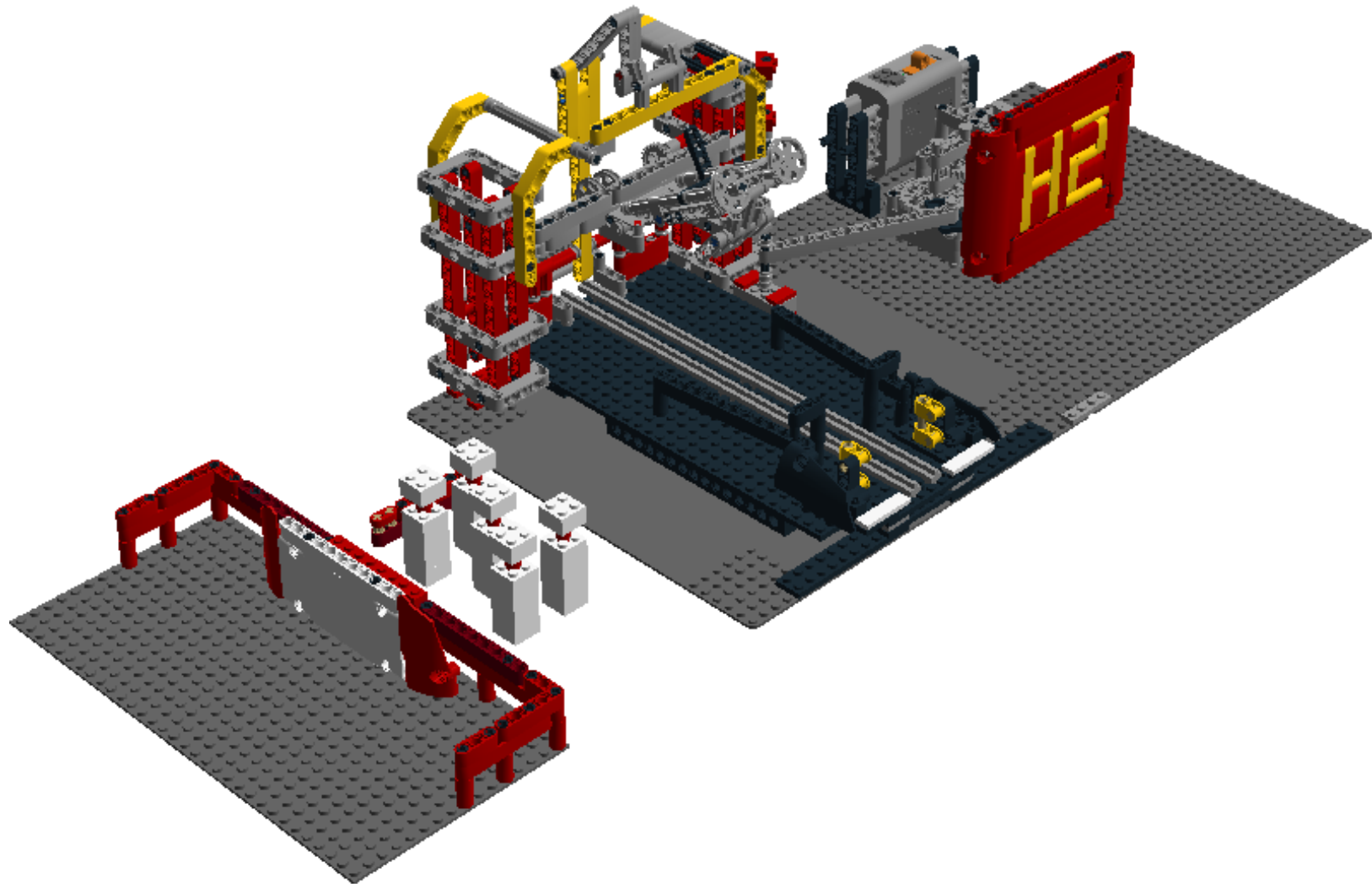

Step 1 of 278



Step 2 of 278

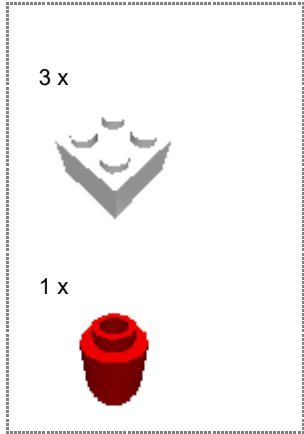

Step 3 of 278



Step 4 of 278



Step 5 of 278

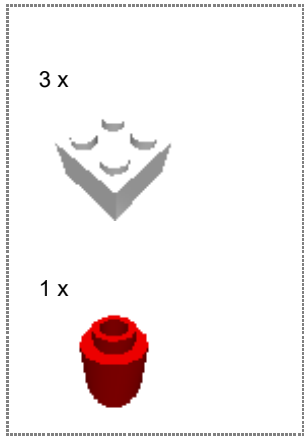

Step 6 of 278



Step 7 of 278



Step 8 of 278

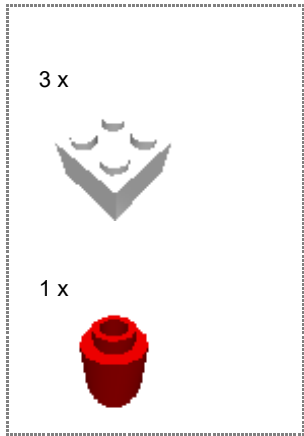

Step 9 of 278



Step 10 of 278



Step 11 of 278

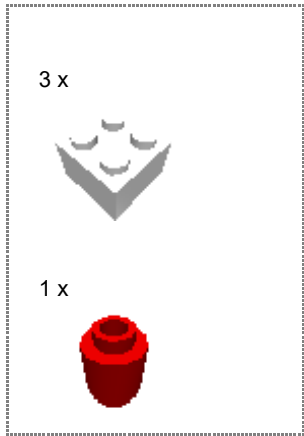

Step 12 of 278



Step 13 of 278



Step 14 of 278

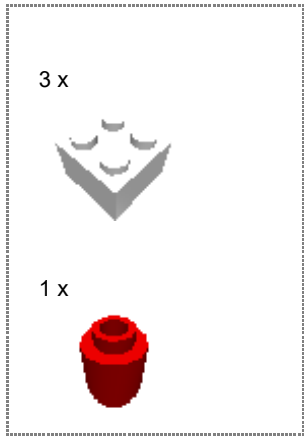

Step 15 of 278



Step 16 of 278

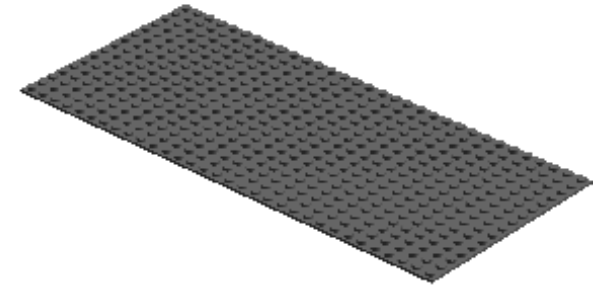
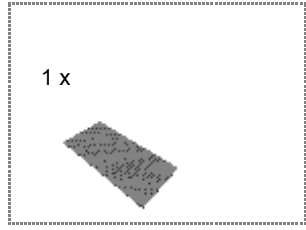

Step 17 of 278

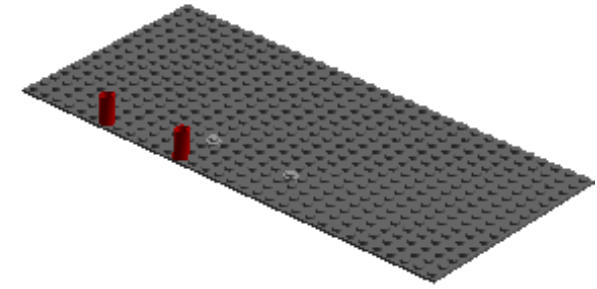
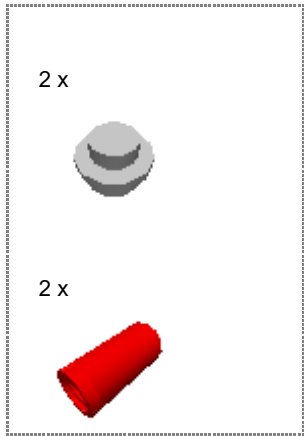

Step 18 of 278

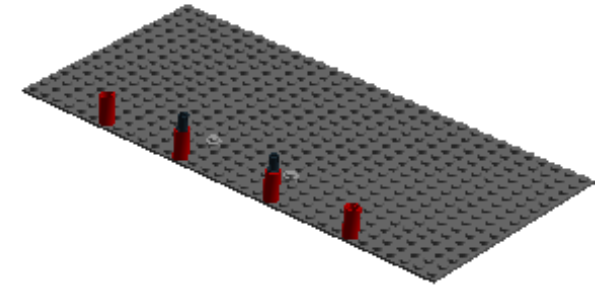
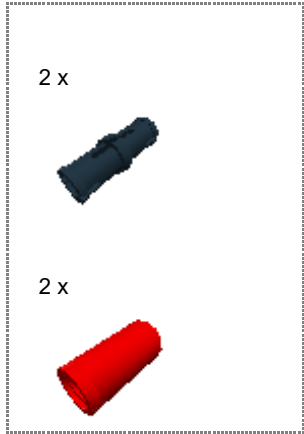

Step 19 of 278

1 x



1 x



1 x



1 x

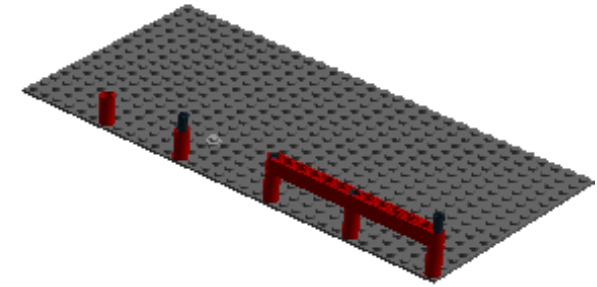

Step 20 of 278

2 x



1 x



1 x

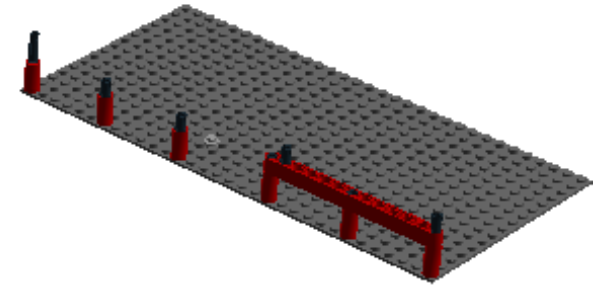

Step 21 of 278

1 x



1 x



2 x

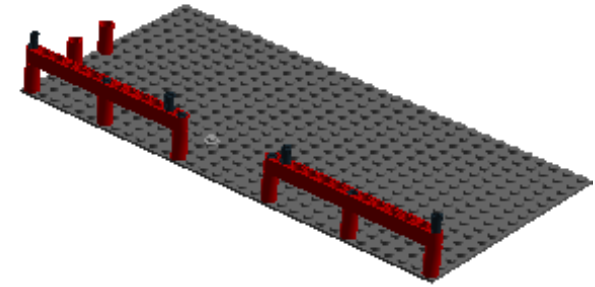

Step 22 of 278

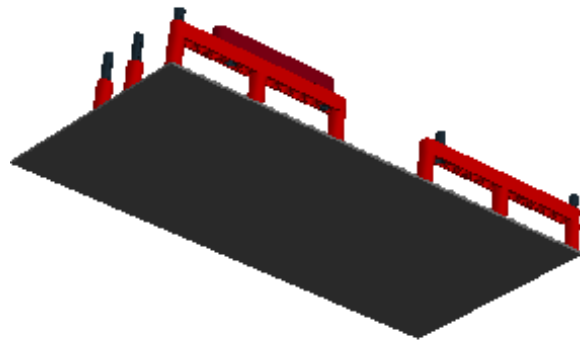
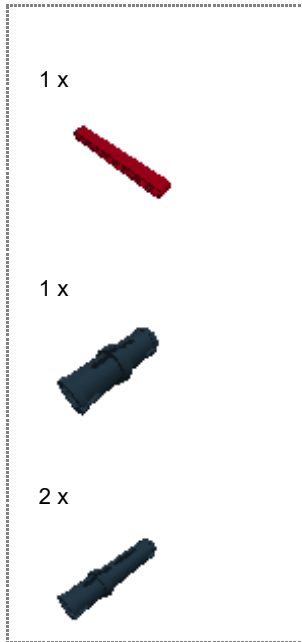

Step 23 of 278

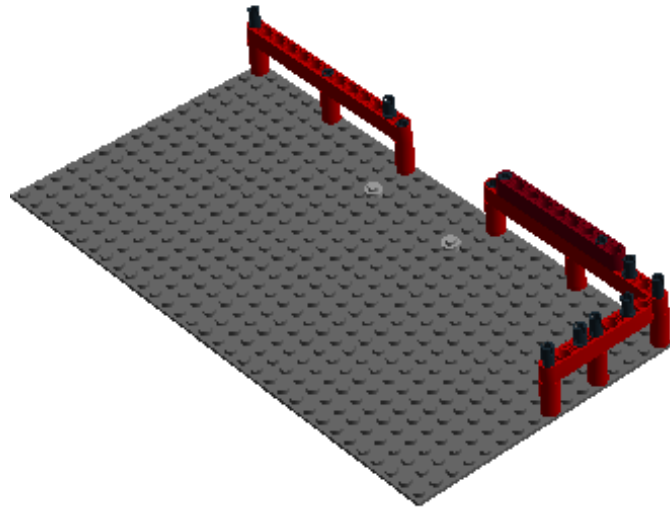
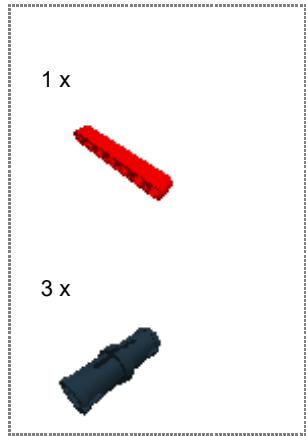

Step 24 of 278

1 x



1 x



2 x

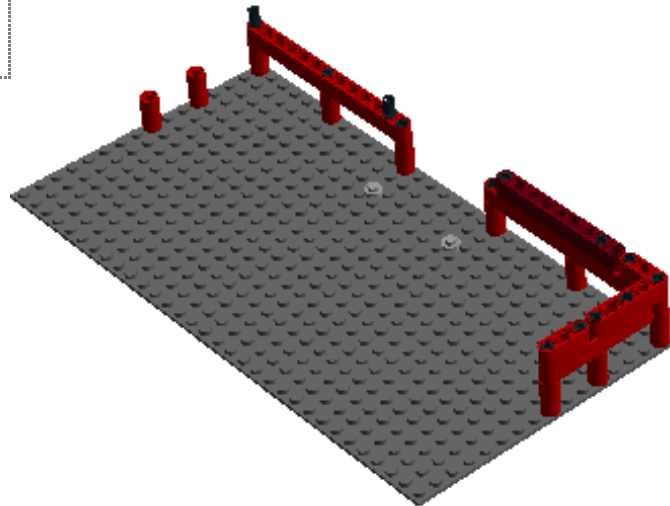

Step 25 of 278

1 x



1 x



2 x

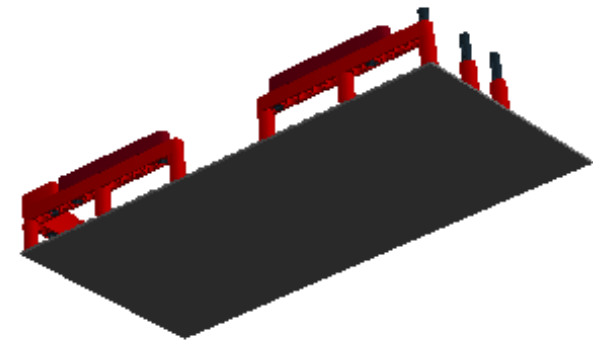

Step 26 of 278

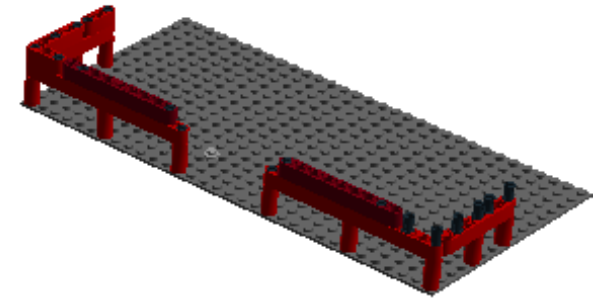
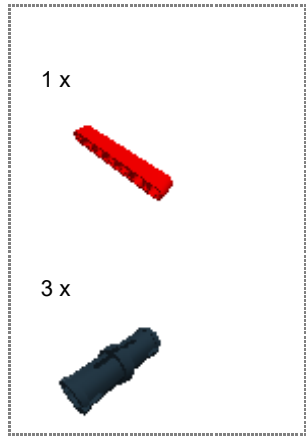

Step 27 of 278

1 x

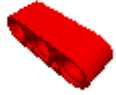

1 x

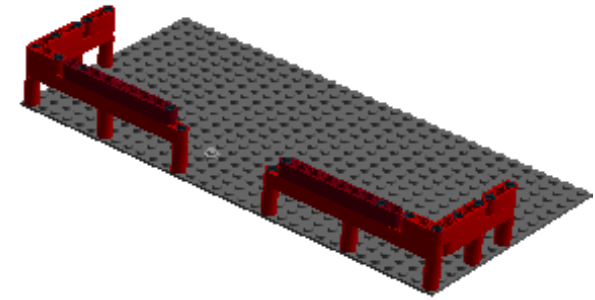

Step 28 of 278

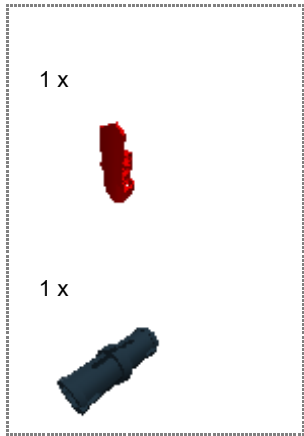

Step 29 of 278

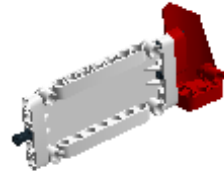
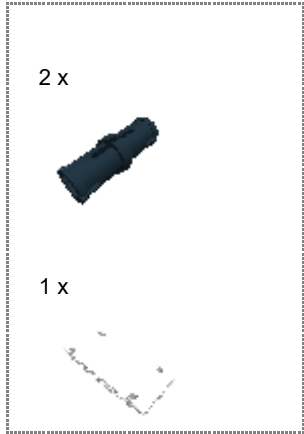

Step 30 of 278

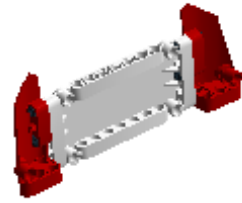
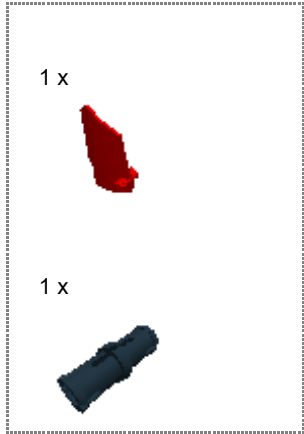

Step 31 of 278

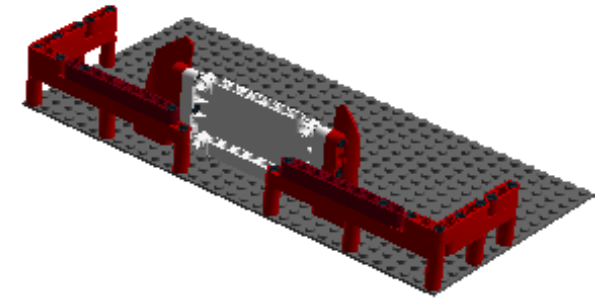

Step 32 of 278

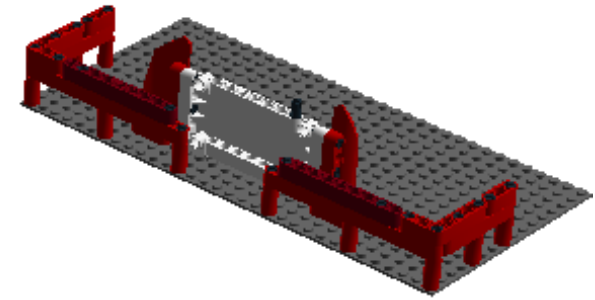

Step 33 of 278

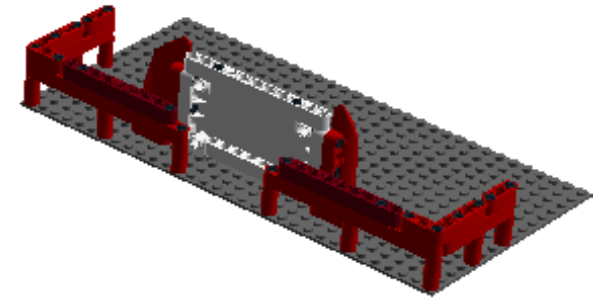
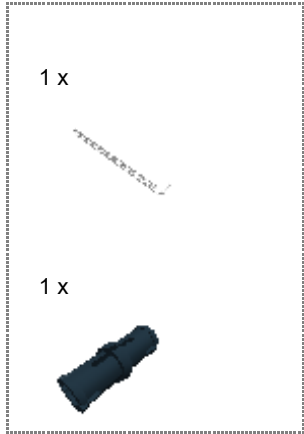

Step 34 of 278

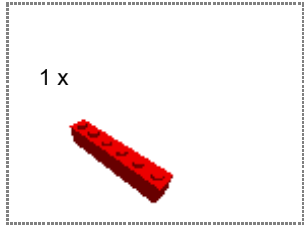

Step 35 of 278

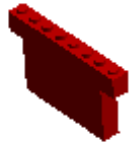
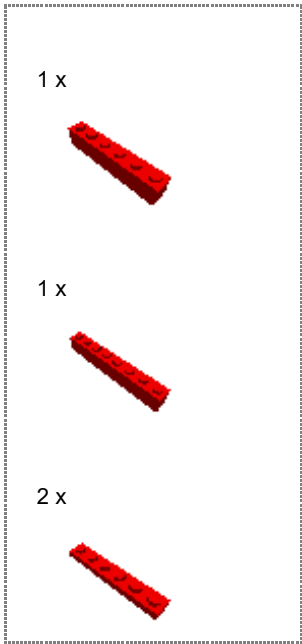

Step 36 of 278

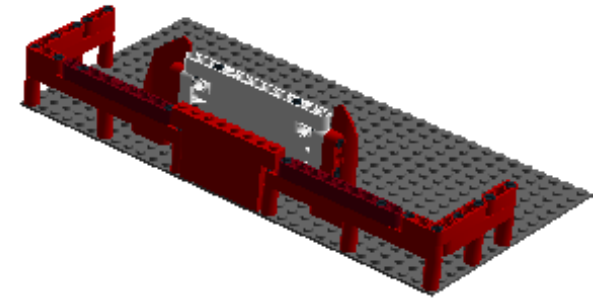

Step 37 of 278

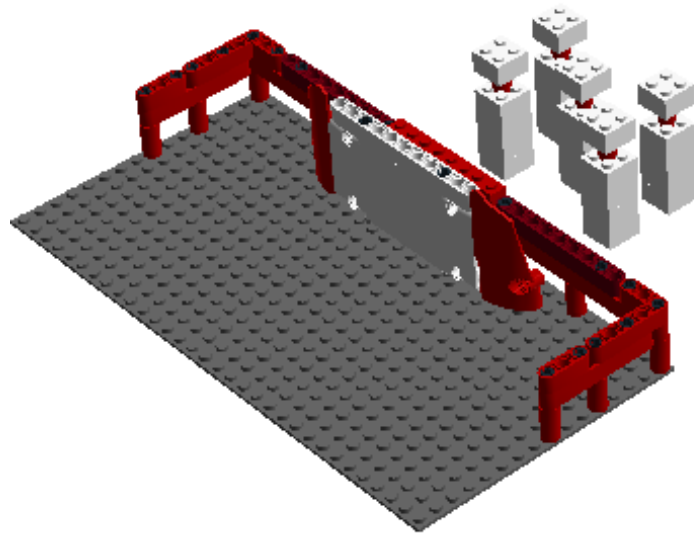

Step 38 of 278

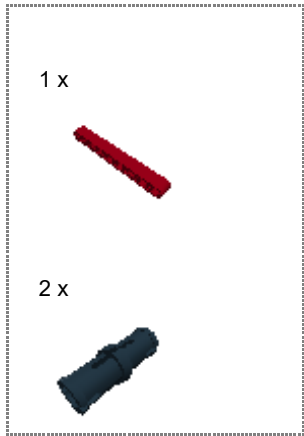

Step 39 of 278

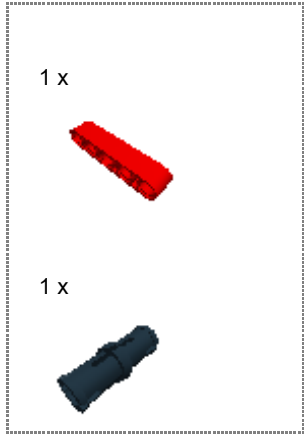

Step 40 of 278

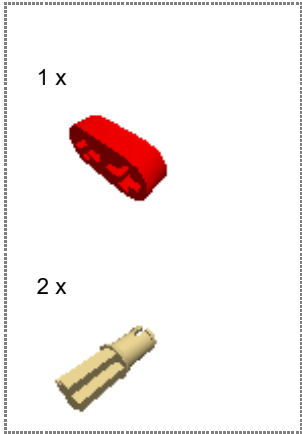

Step 41 of 278



Step 42 of 278

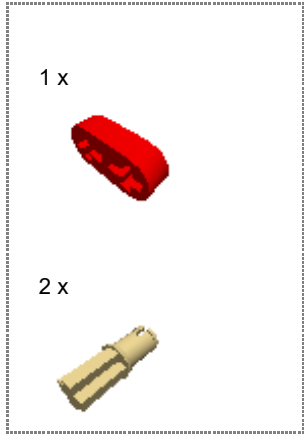

Step 43 of 278



Step 44 of 278

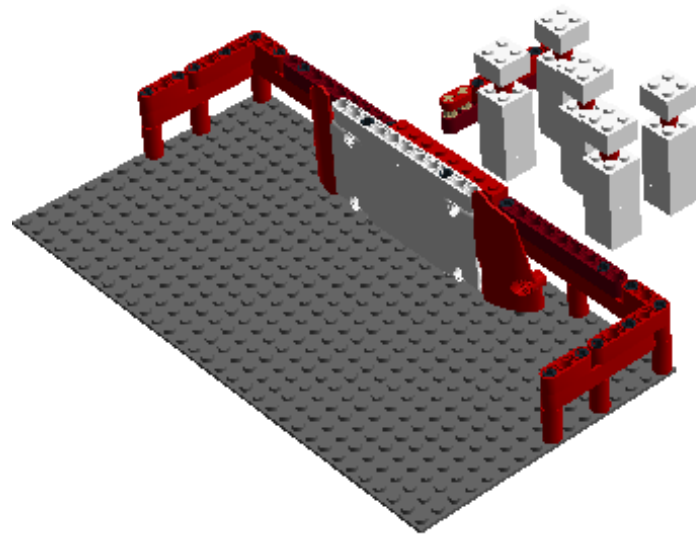

Step 45 of 278

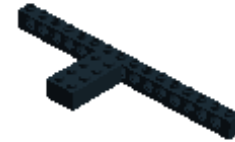
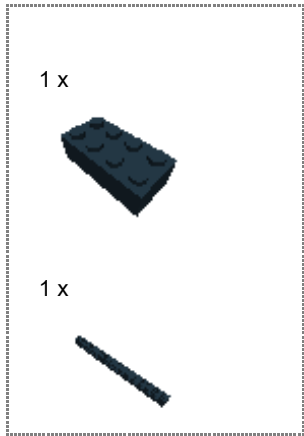

Step 46 of 278

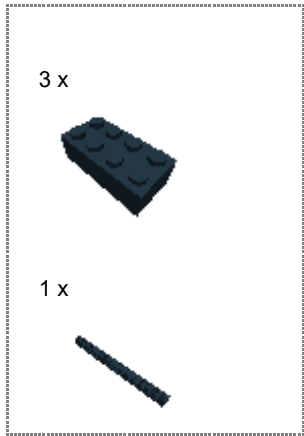

Step 47 of 278

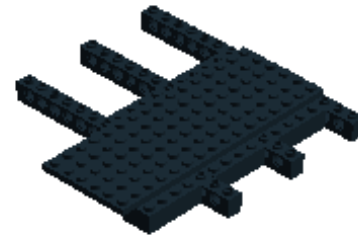

Step 48 of 278

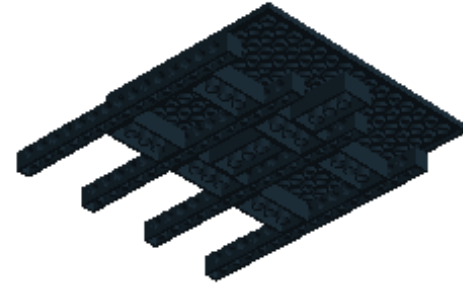

Step 49 of 278

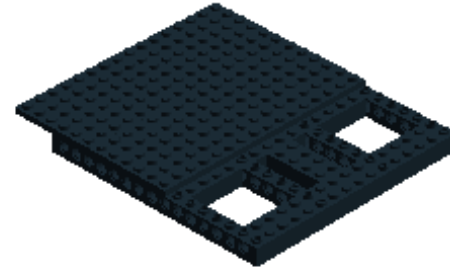

Step 50 of 278

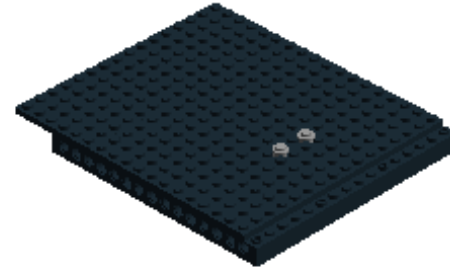
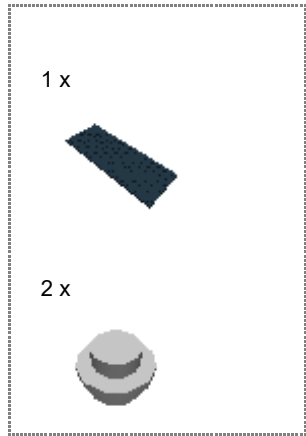

Step 51 of 278

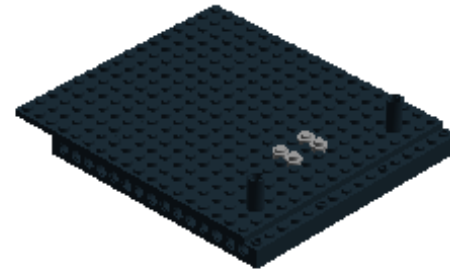

Step 52 of 278

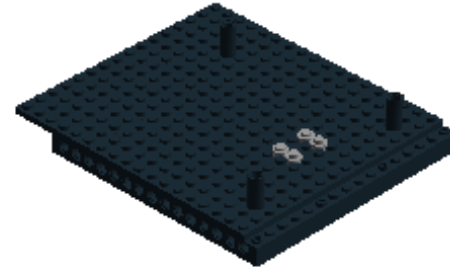

Step 53 of 278

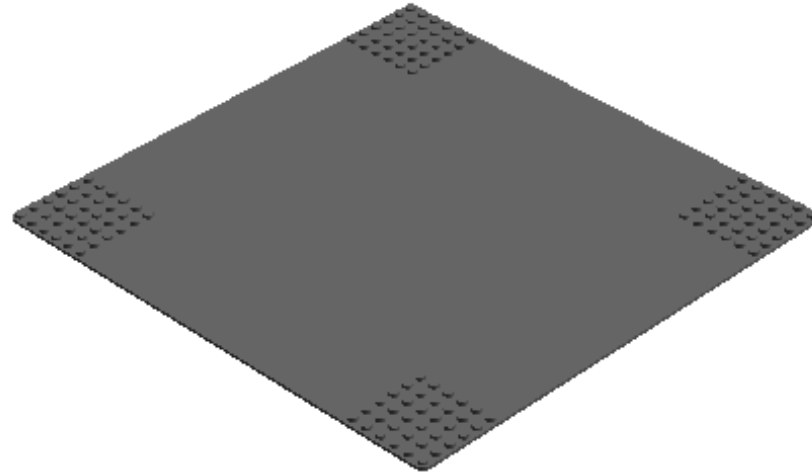
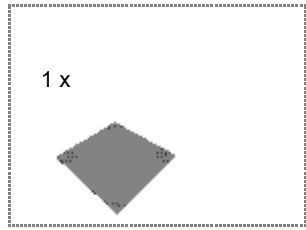

Step 54 of 278

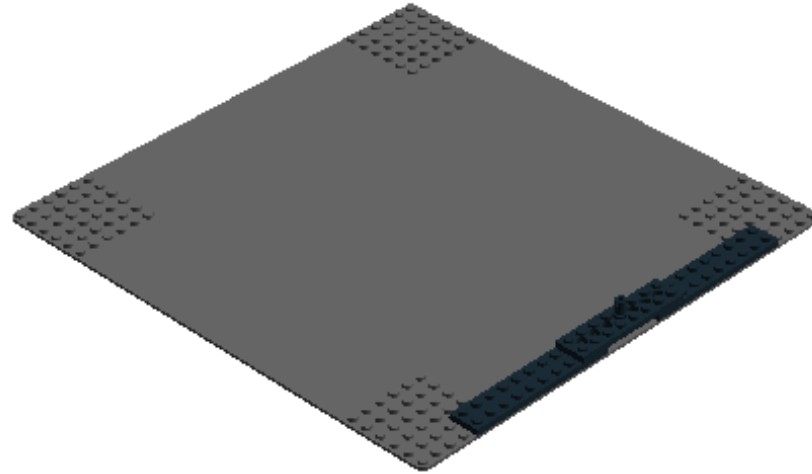
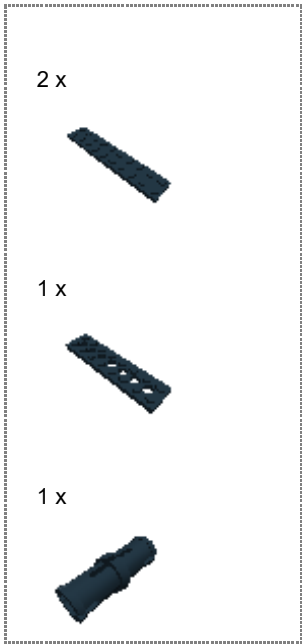

Step 55 of 278

1 x



2 x



1 x

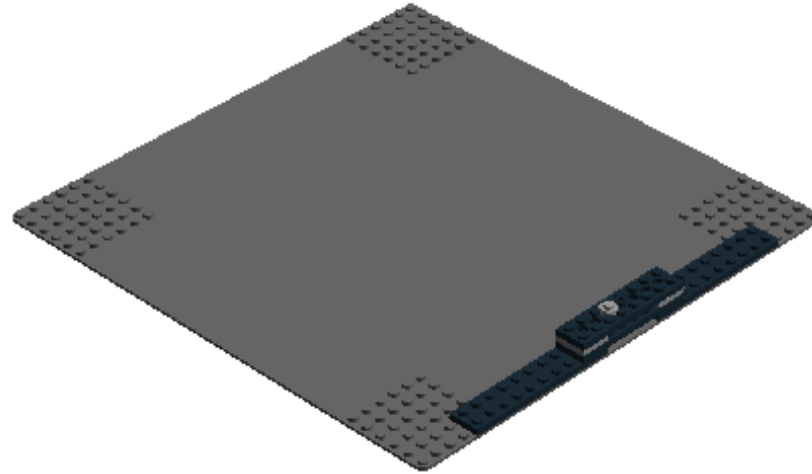

Step 56 of 278

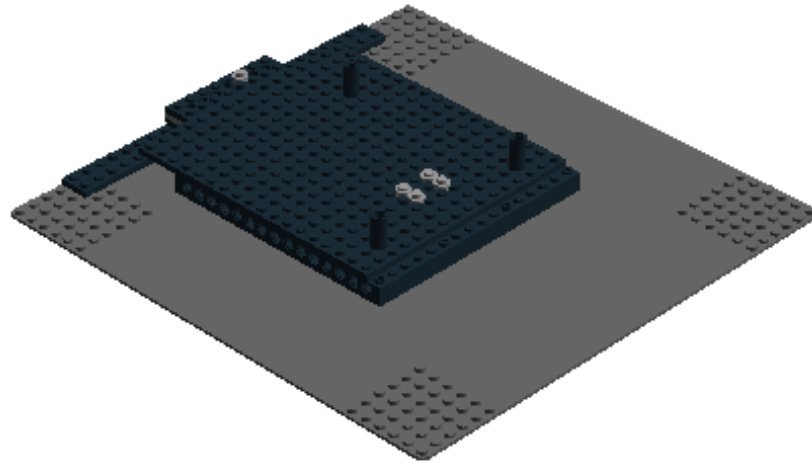

Step 57 of 278

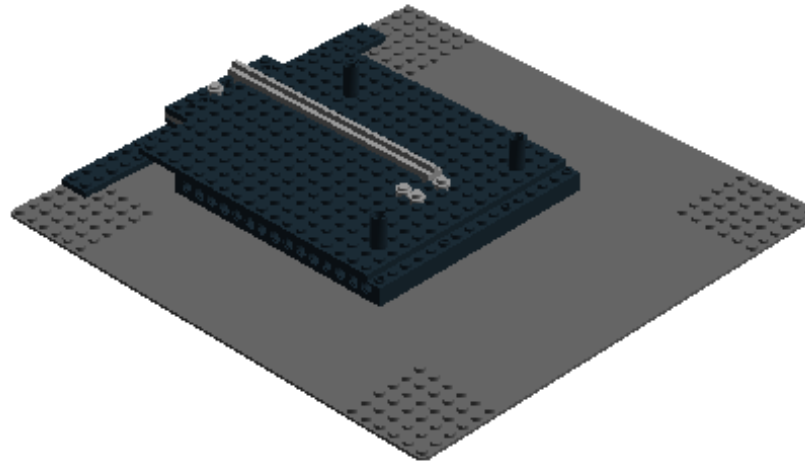
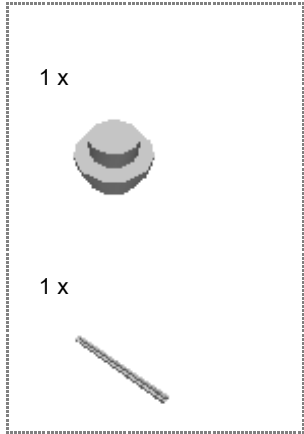

Step 58 of 278

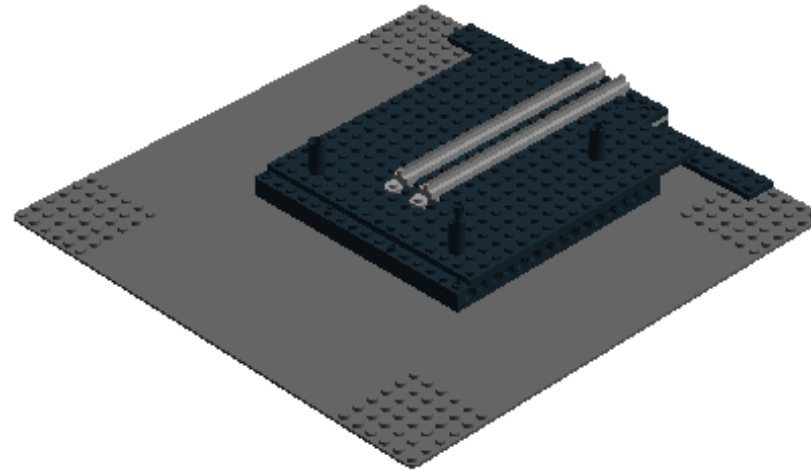
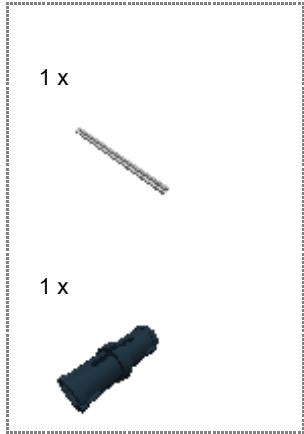

Step 59 of 278

1 x



2 x



1 x

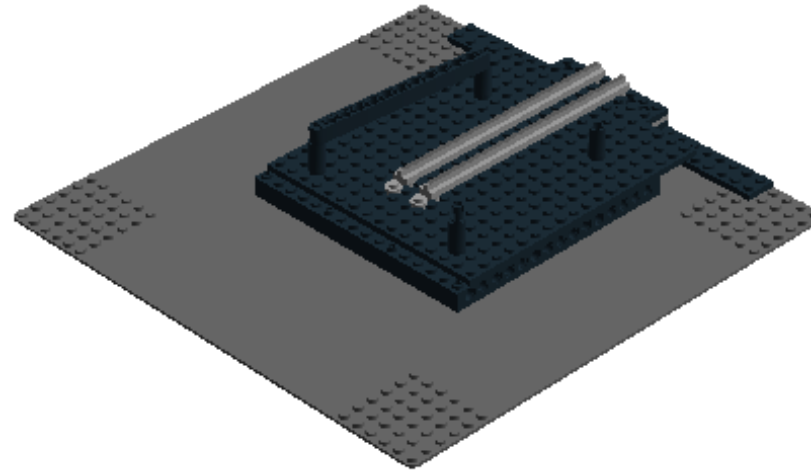
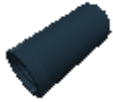

Step 60 of 278

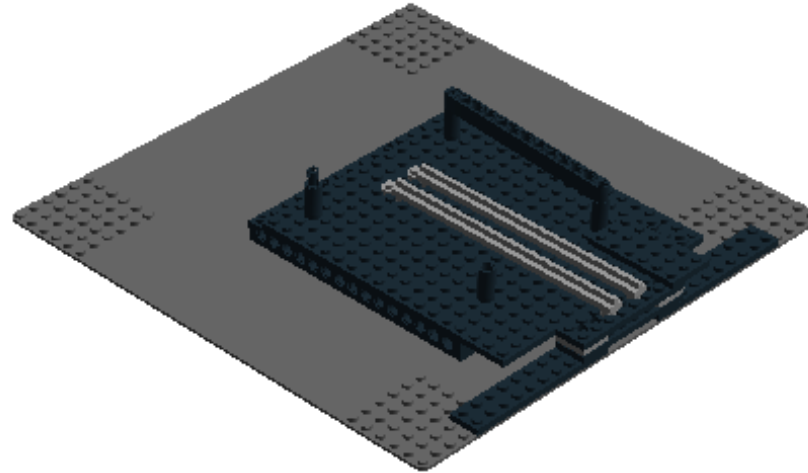
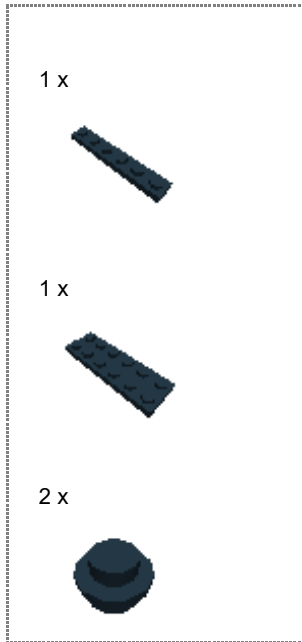

Step 61 of 278

1 x

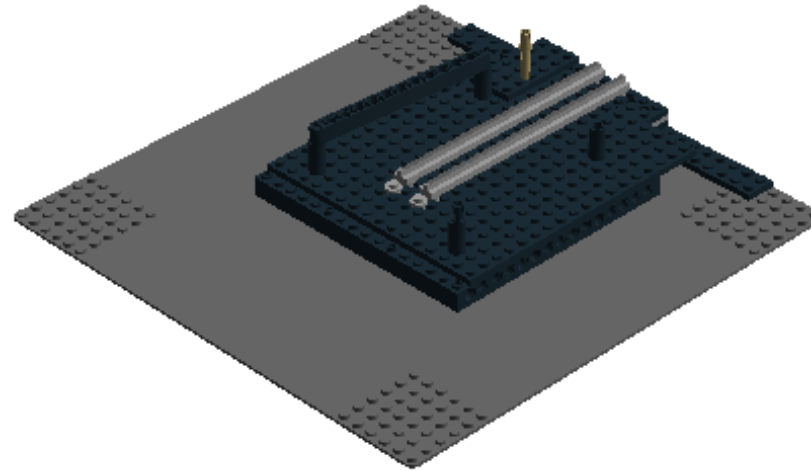

Step 62 of 278

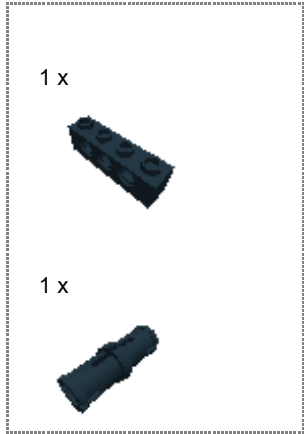

Step 63 of 278

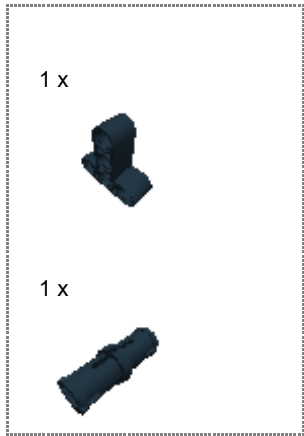

Step 64 of 278

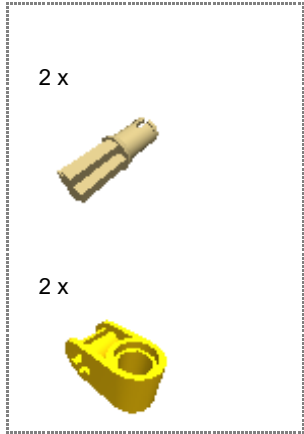

Step 65 of 278

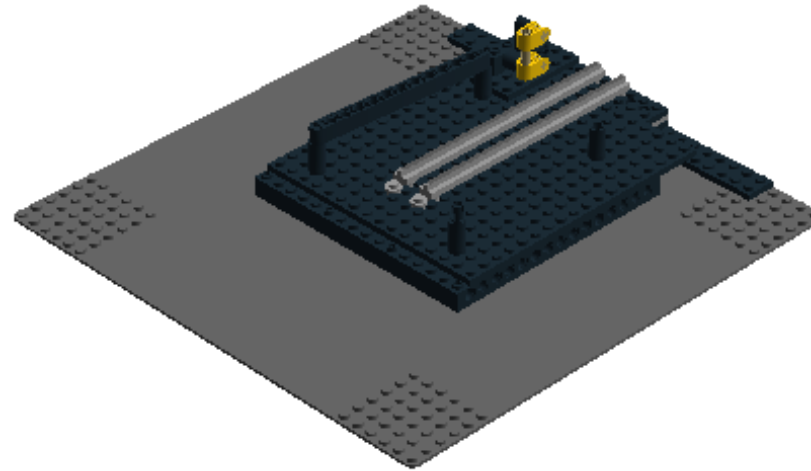

Step 66 of 278

1 x



1 x



1 x

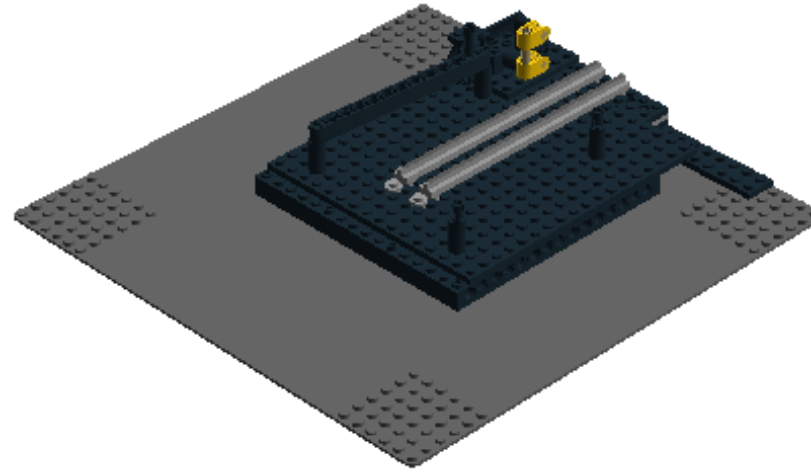

Step 67 of 278

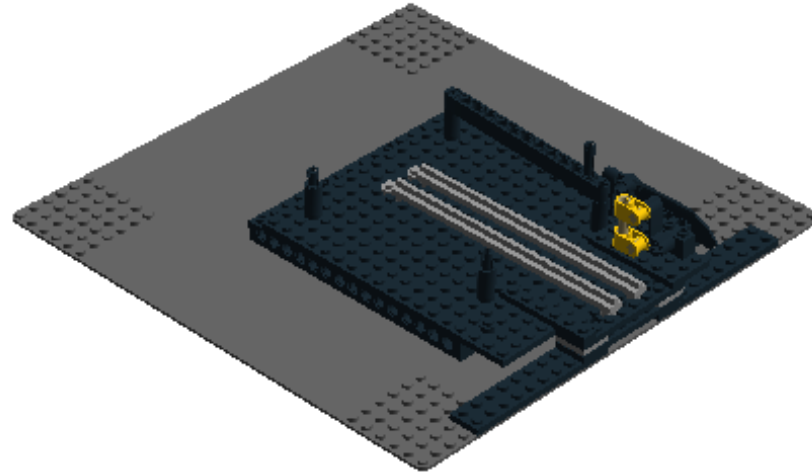
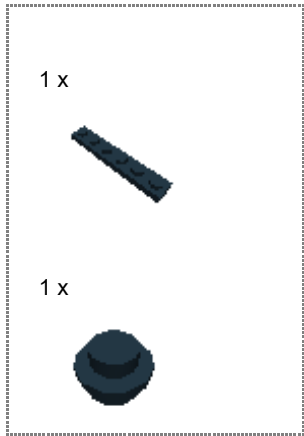

Step 68 of 278

1 x



1 x



1 x

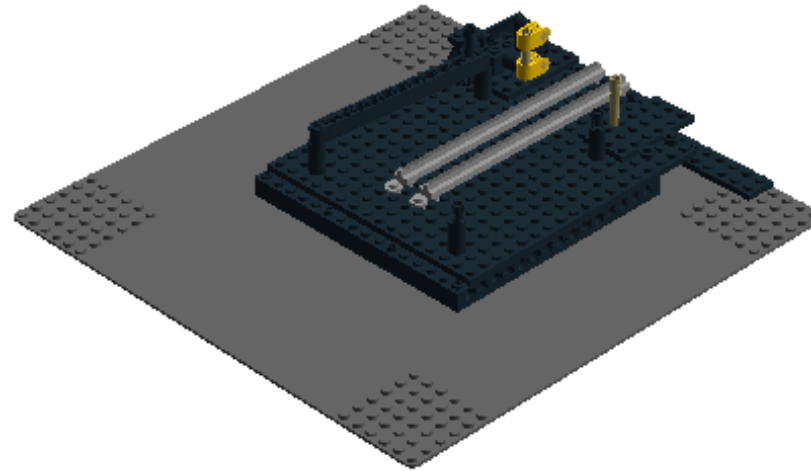

Step 69 of 278

1 x



1 x



2 x



Step 70 of 278

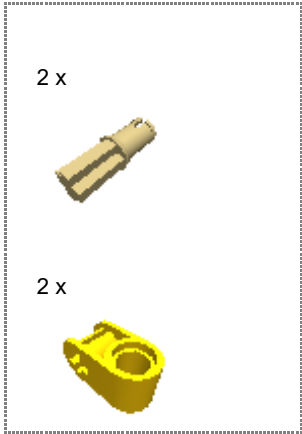

Step 71 of 278

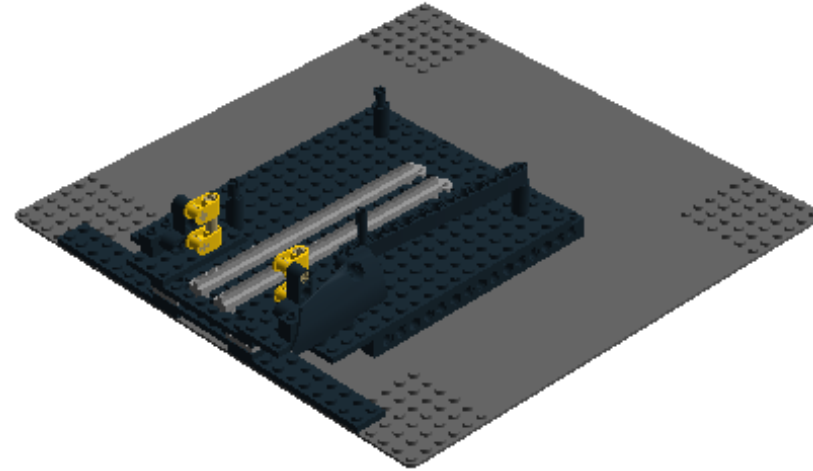

Step 72 of 278

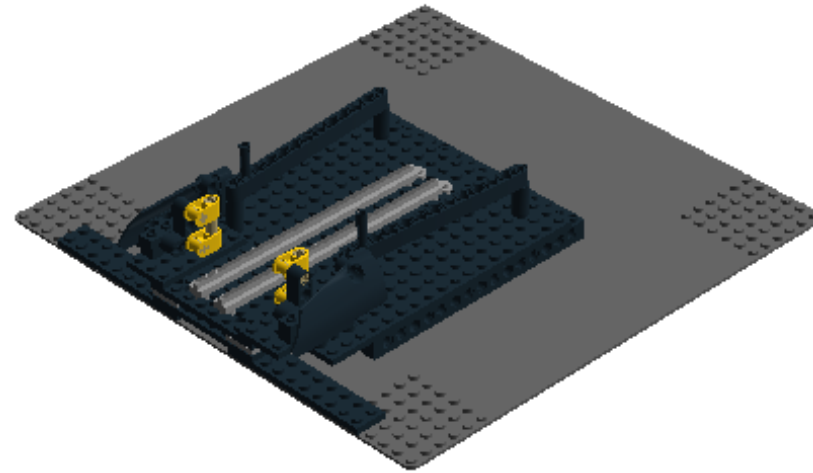
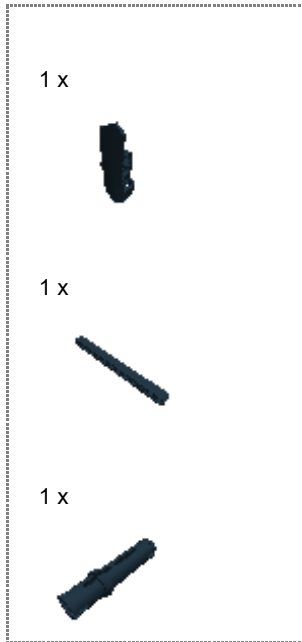

Step 73 of 278

2 x



1 x



1 x

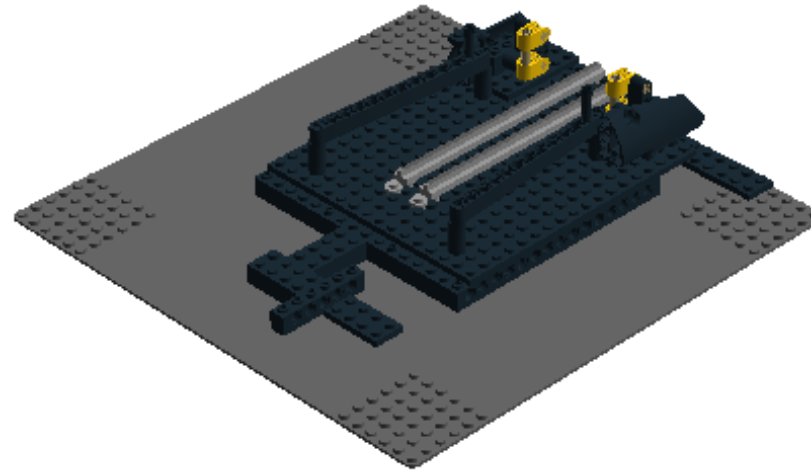

Step 74 of 278

1 x



2 x



1 x

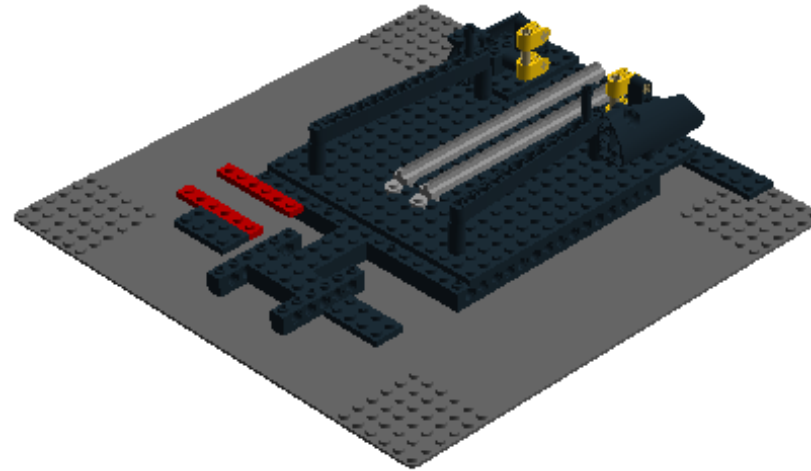

Step 75 of 278

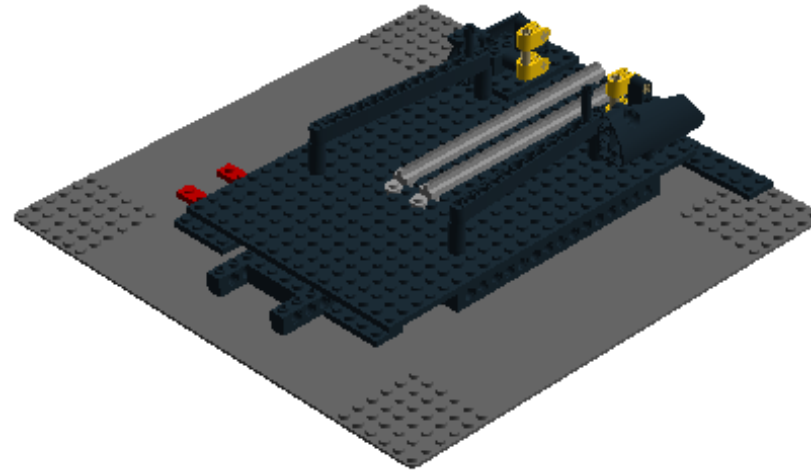
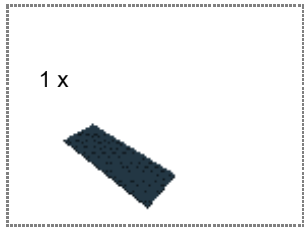

Step 76 of 278

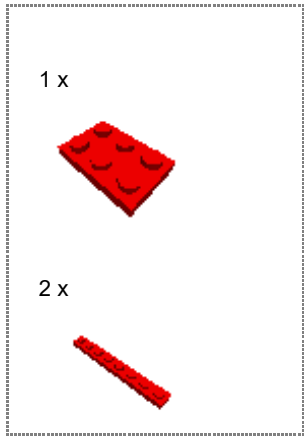

Step 77 of 278

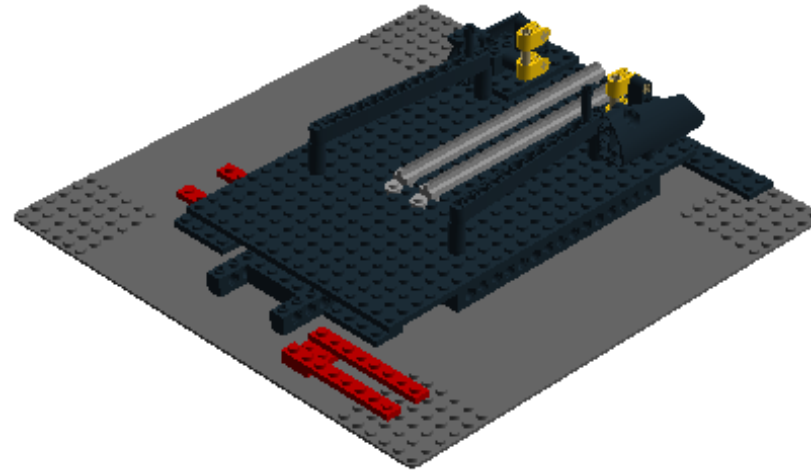

Step 78 of 278

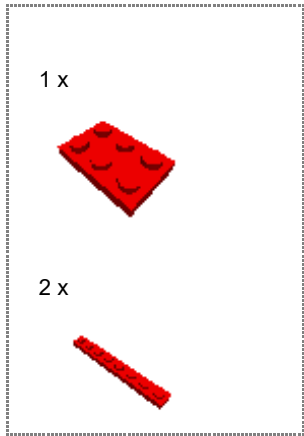

Step 79 of 278

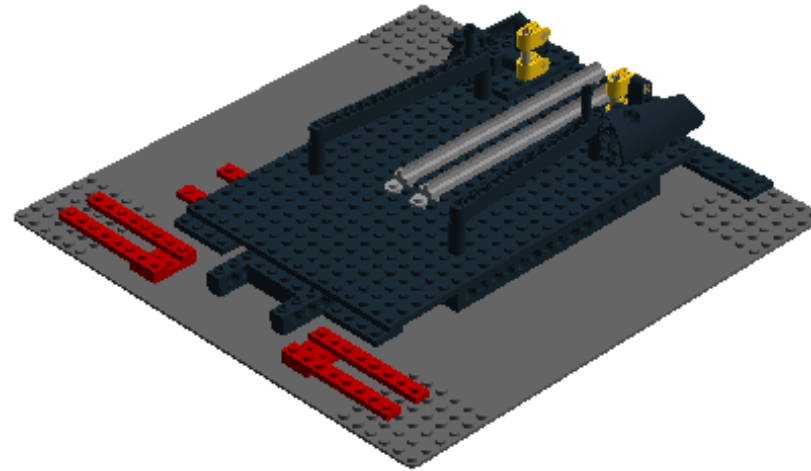

Step 80 of 278

1 x

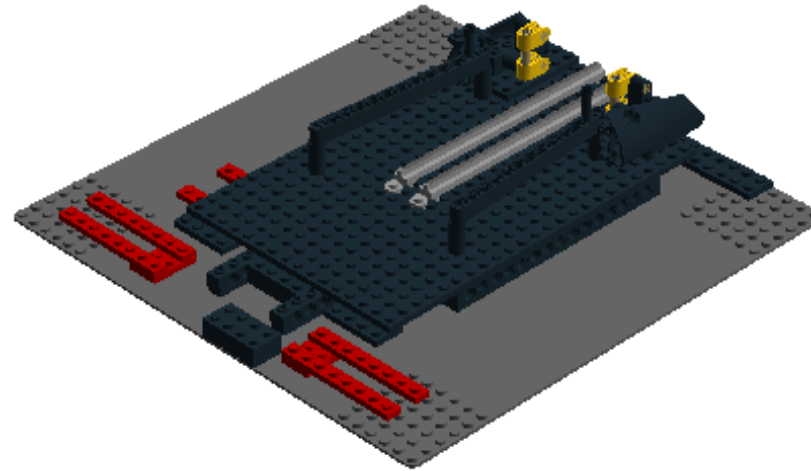
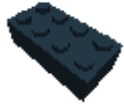

Step 81 of 278

1 x



1 x

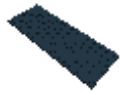

1 x



1 x

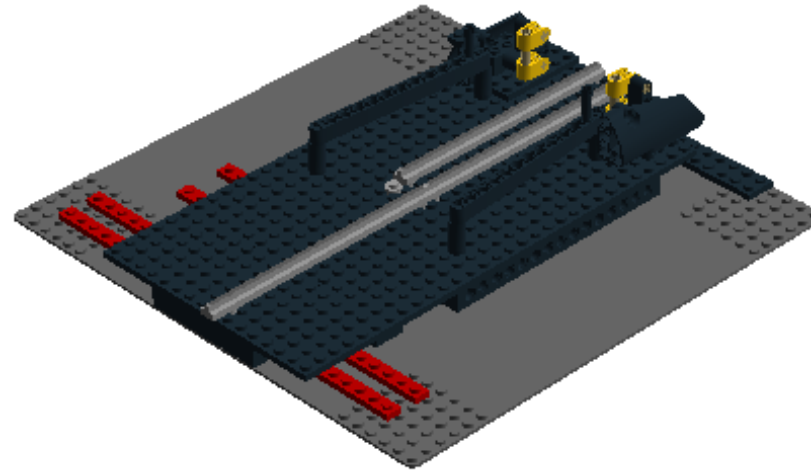

Step 82 of 278

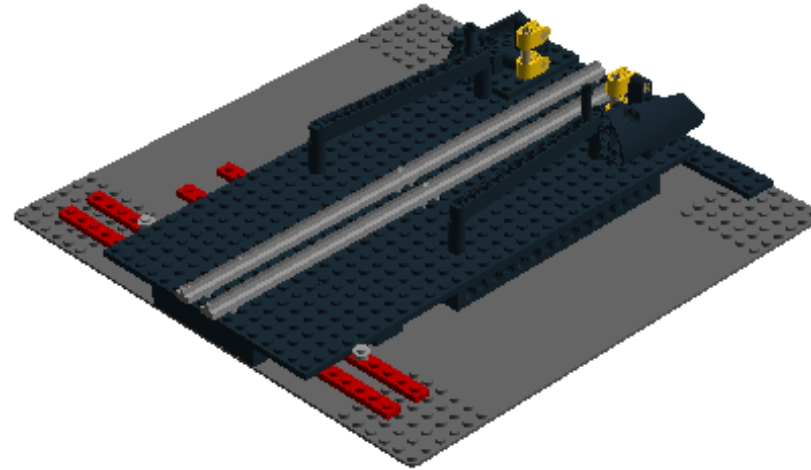
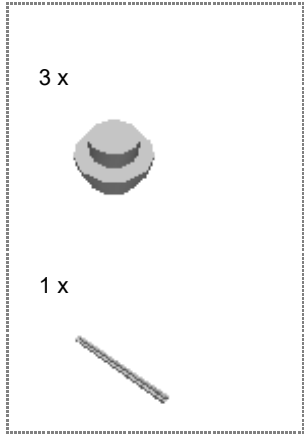

Step 83 of 278

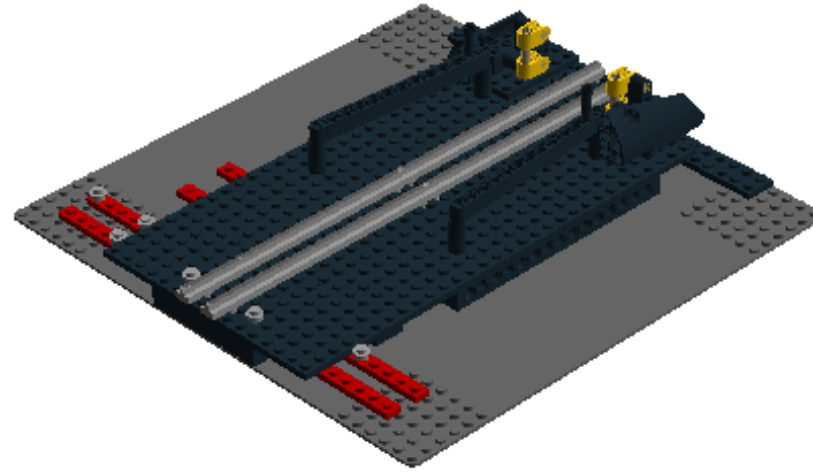
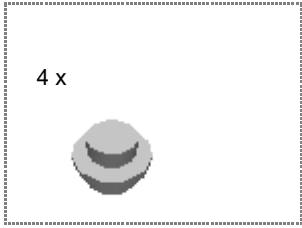

Step 84 of 278

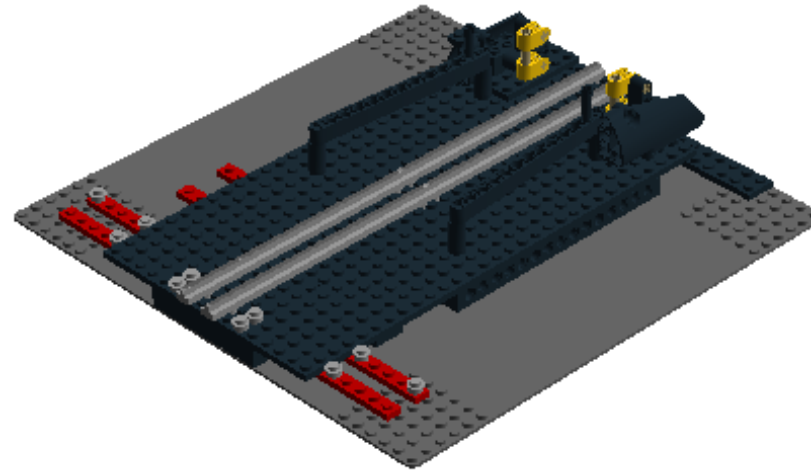
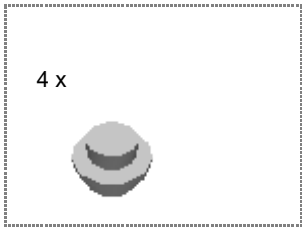

Step 85 of 278

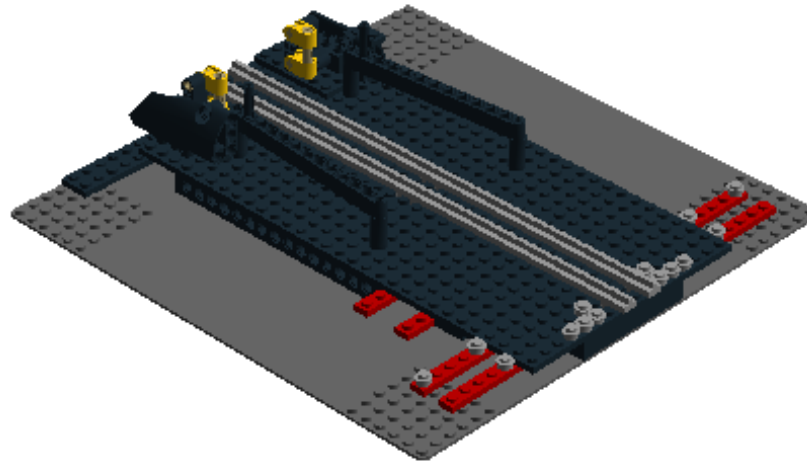
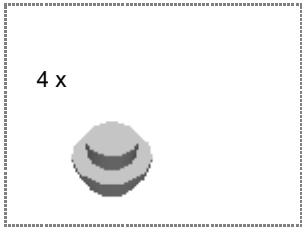

Step 86 of 278

2 x



1 x

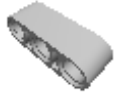

1 x

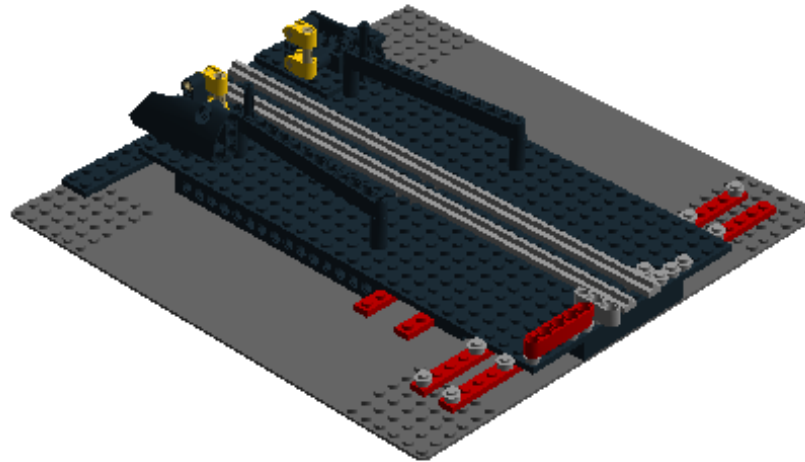

Step 87 of 278

2 x

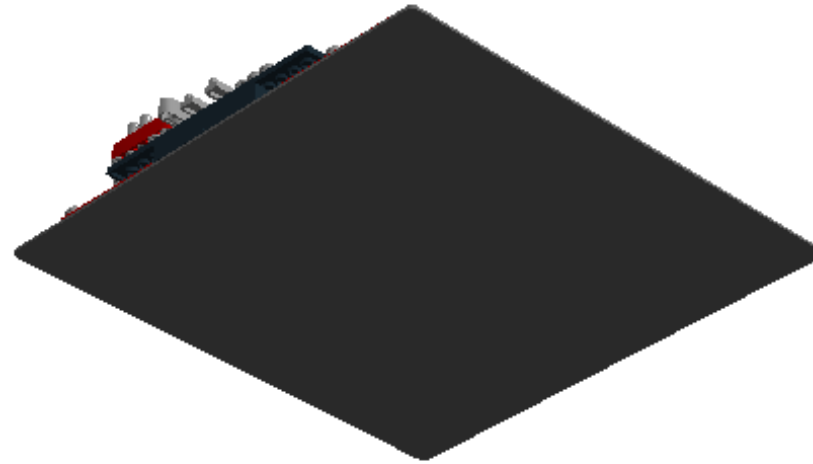

Step 88 of 278

1 x



1 x

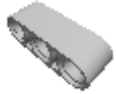

1 x

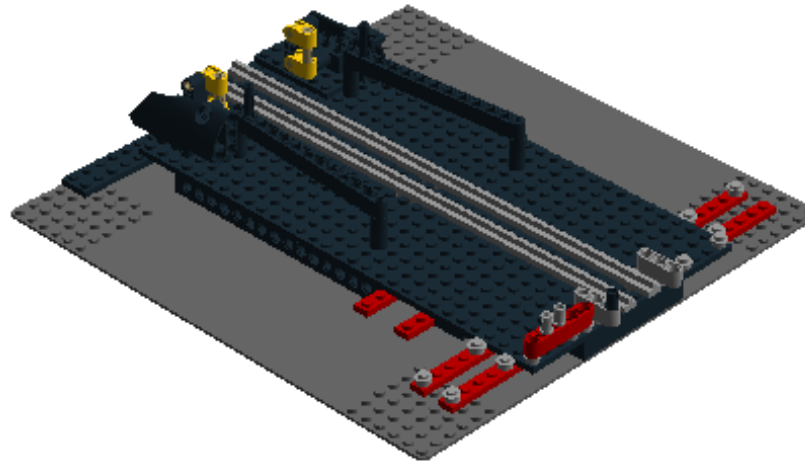

Step 89 of 278

1 x



1 x

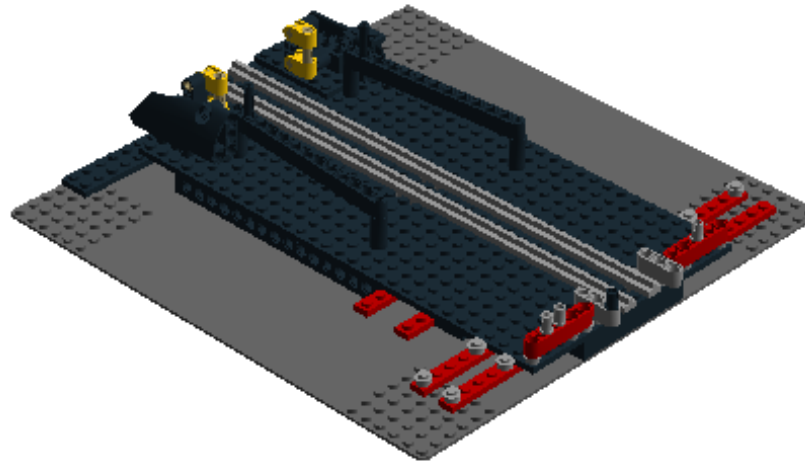

Step 90 of 278

1 x



1 x



1 x



1 x

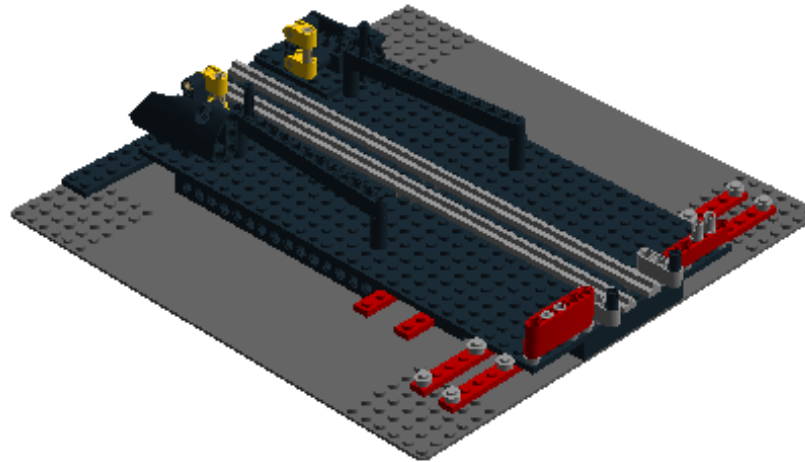

Step 91 of 278

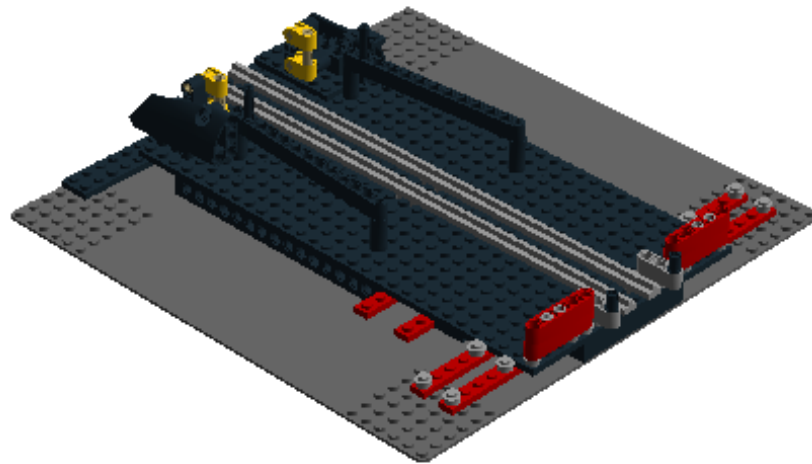
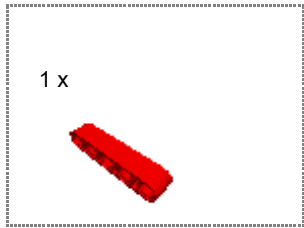

Step 92 of 278

1 x



1 x



1 x



Step 93 of 278

1 x



1 x



1 x

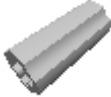

1 x



Step 94 of 278

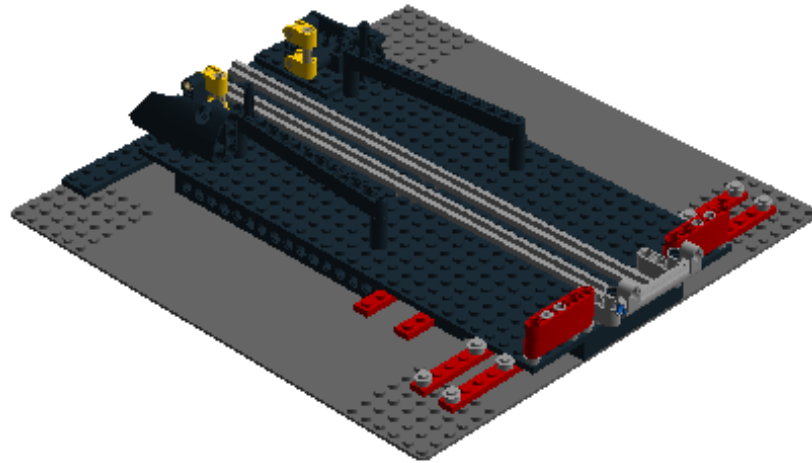

Step 95 of 278

2 x

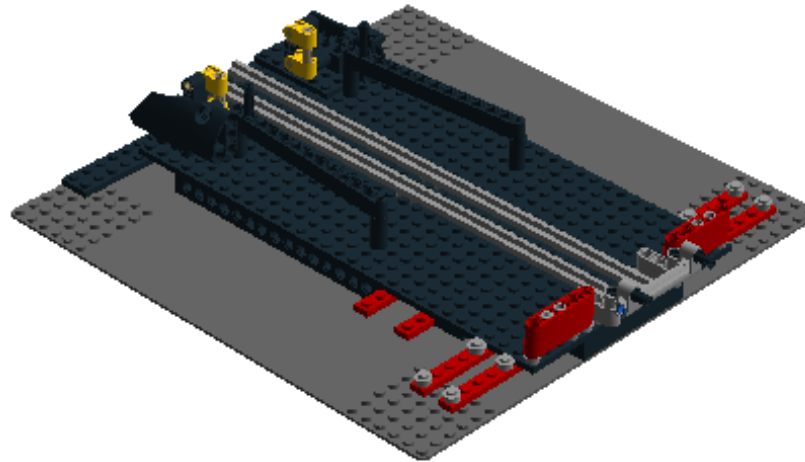

Step 96 of 278

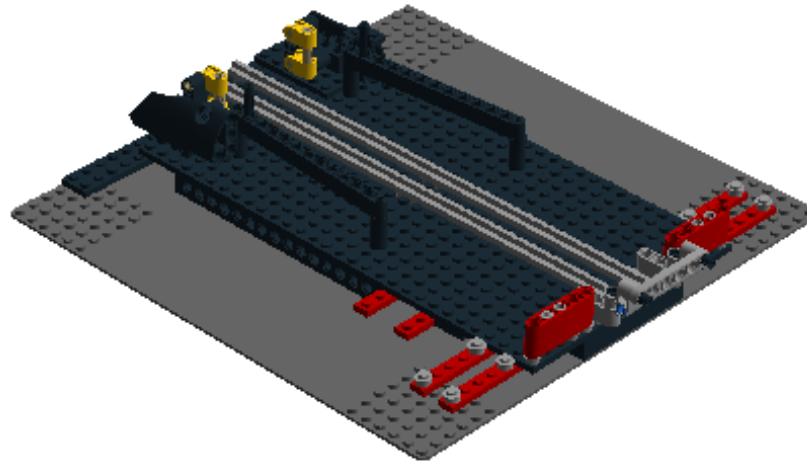
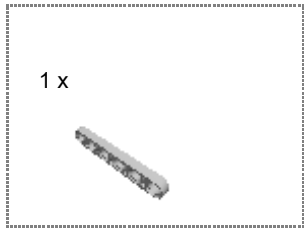

Step 97 of 278

1 x



1 x



1 x



Step 98 of 278

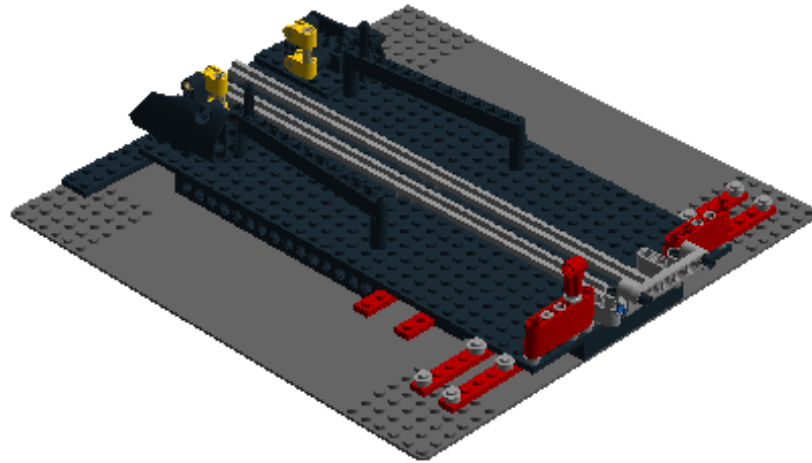

Step 99 of 278

1 x



1 x



1 x



Step 100 of 278

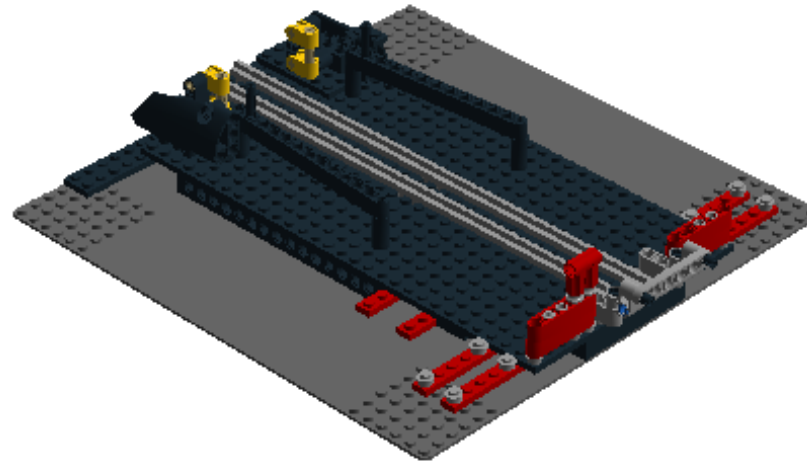

Step 101 of 278

1 x

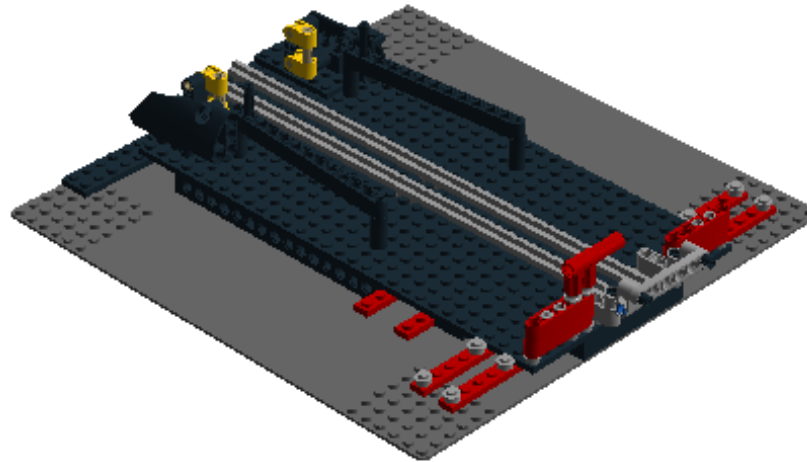
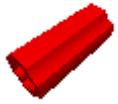

Step 102 of 278

2 x



1 x



1 x

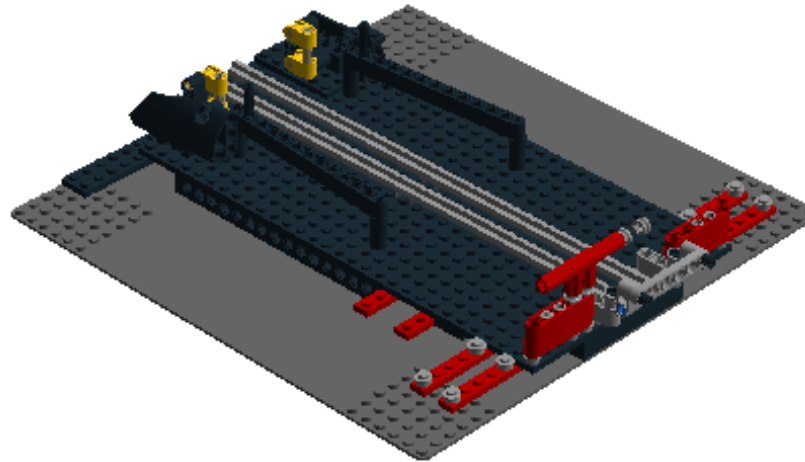
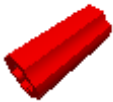

Step 103 of 278

1 x



1 x



1 x

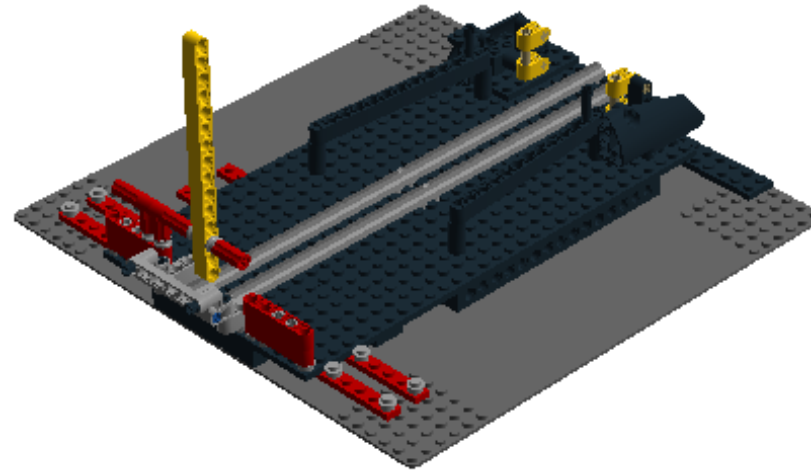

Step 104 of 278

1 x



1 x



1 x



Step 105 of 278

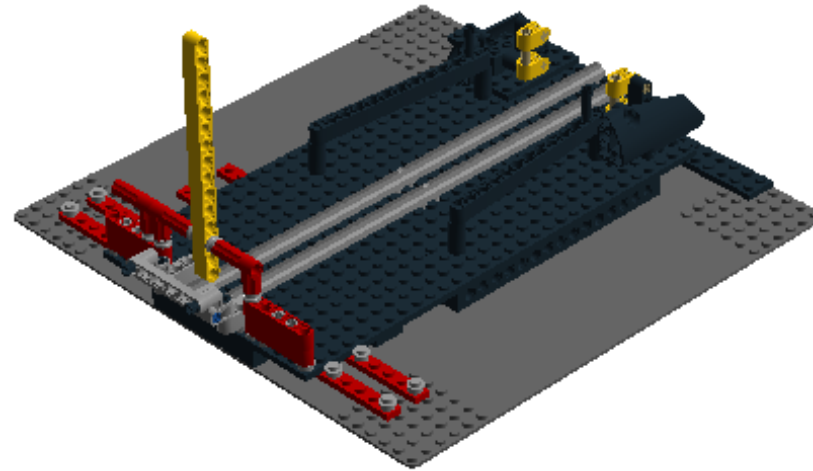

Step 106 of 278

1 x



1 x



1 x



Step 107 of 278

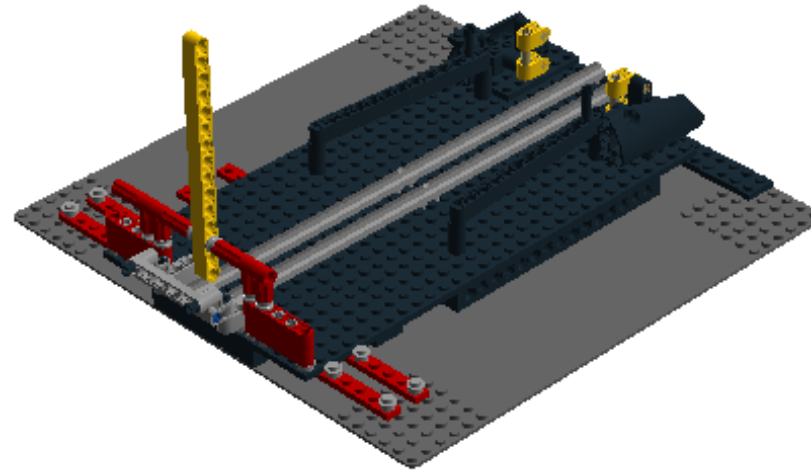

Step 108 of 278

1 x



1 x



1 x

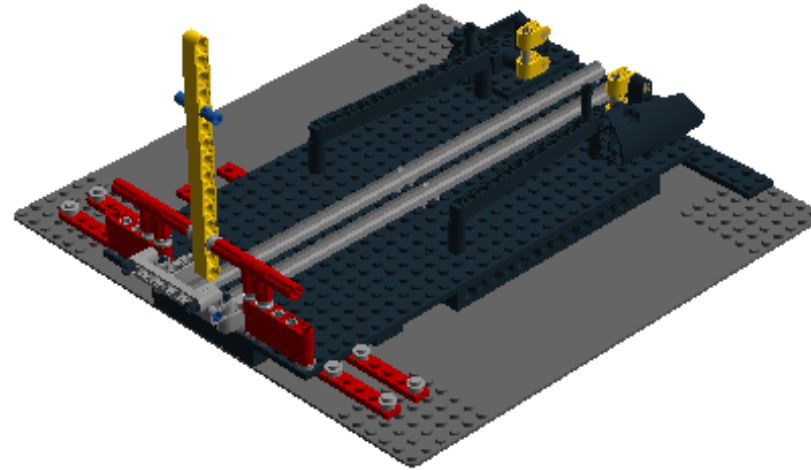
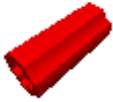

Step 109 of 278

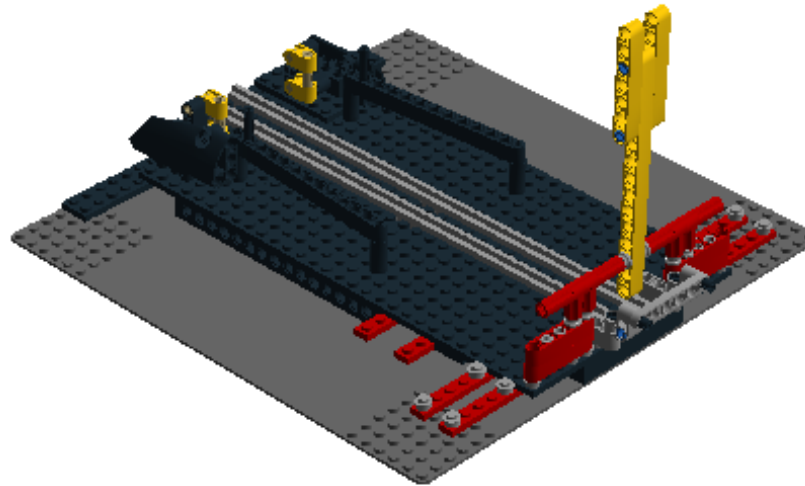
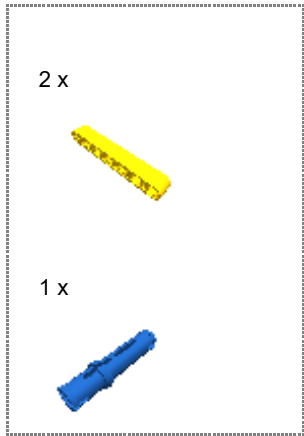

Step 110 of 278

1 x



1 x



1 x



Step 111 of 278

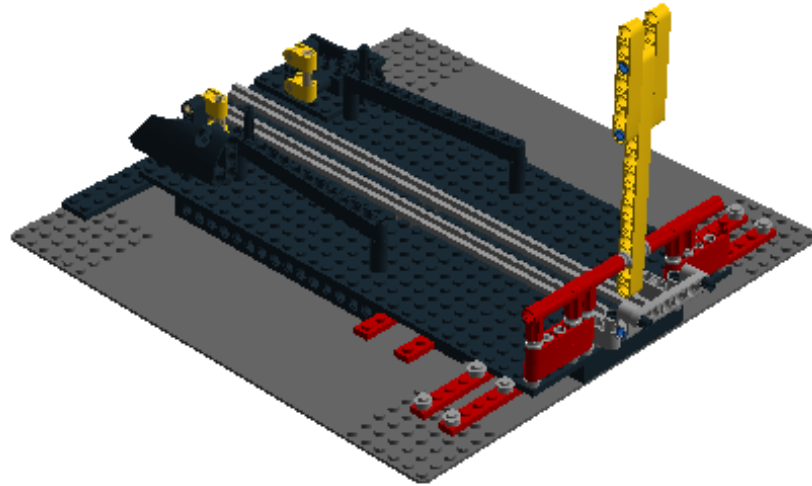

Step 112 of 278

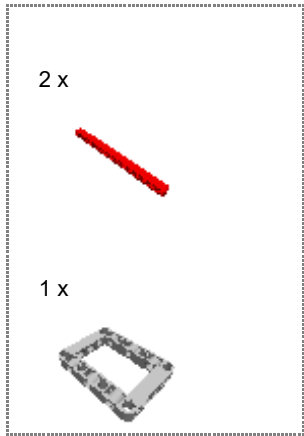

Step 113 of 278

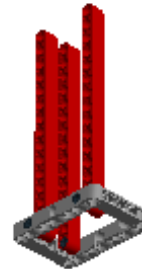
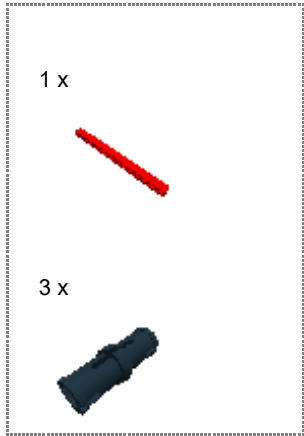

Step 114 of 278

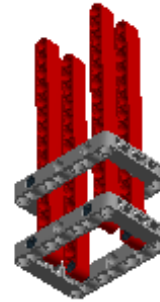
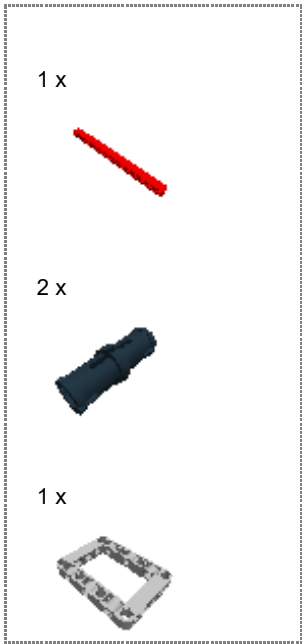

Step 115 of 278

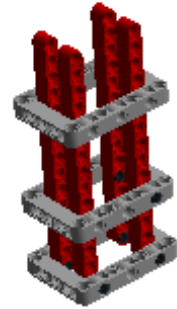
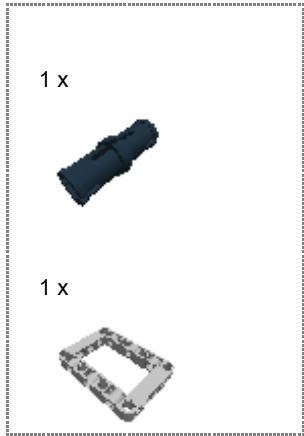

Step 116 of 278

1 x

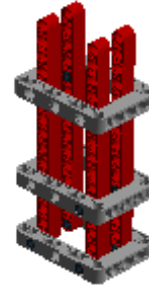

Step 117 of 278

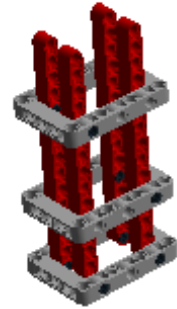

Step 118 of 278

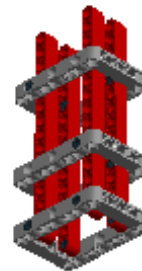

Step 119 of 278

3 x

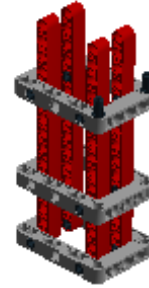

Step 120 of 278

1 x



2 x



1 x



Step 121 of 278

1 x

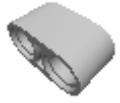

3 x

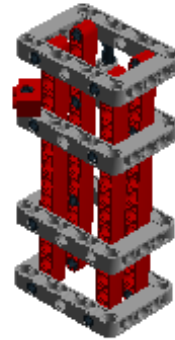

Step 122 of 278

1 x



1 x



2 x



Step 123 of 278

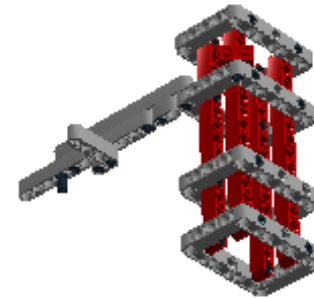
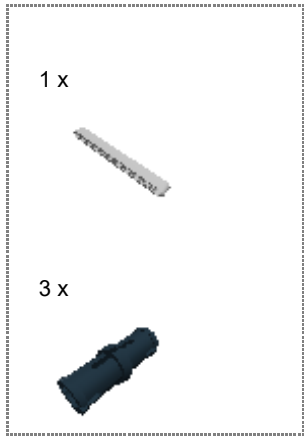

Step 124 of 278

1 x



3 x

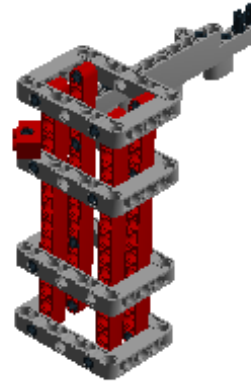

Step 125 of 278

1 x

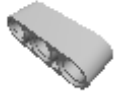

1 x



1 x

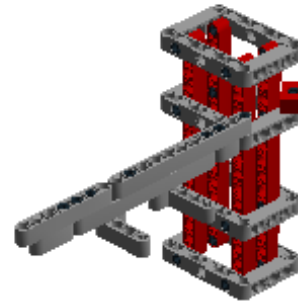

Step 126 of 278

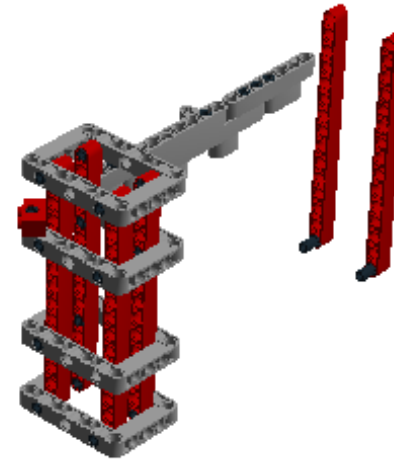
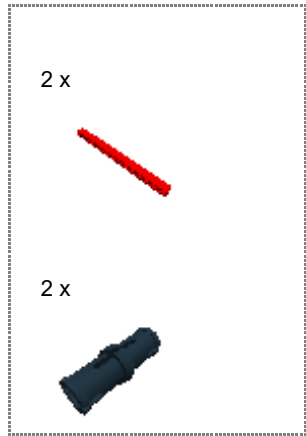

Step 127 of 278

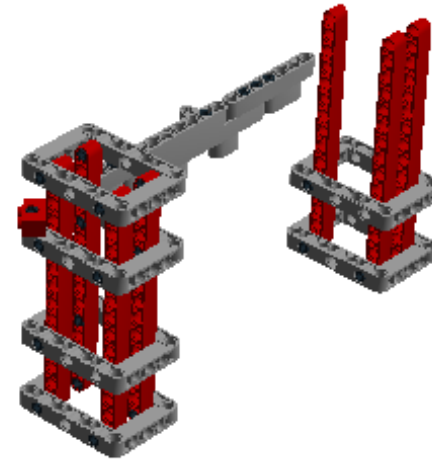
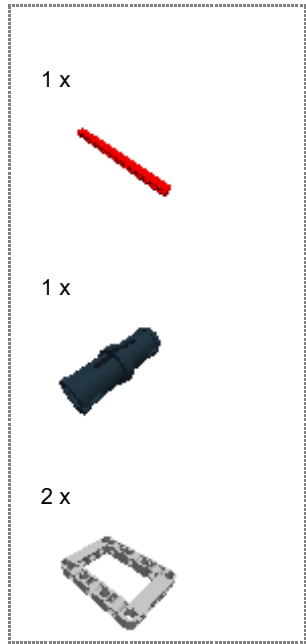

Step 128 of 278

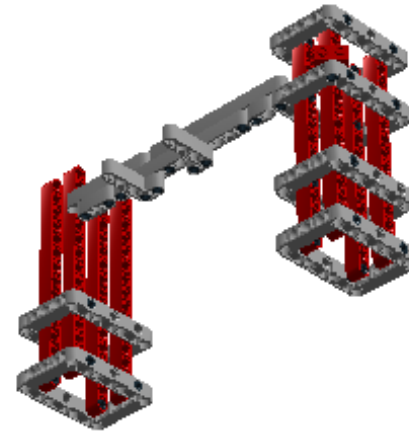
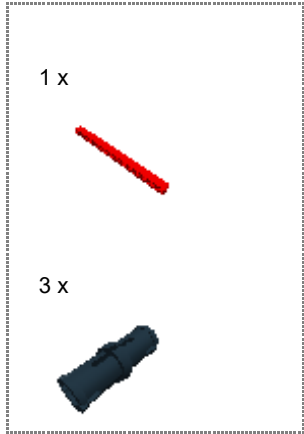

Step 129 of 278

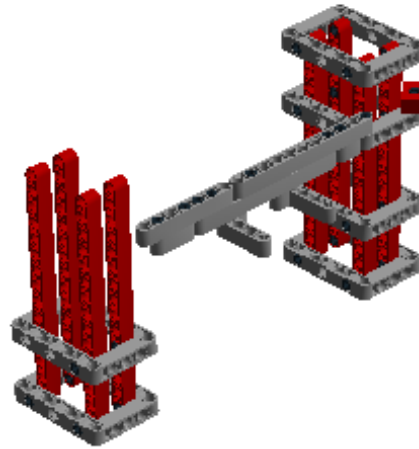

Step 130 of 278

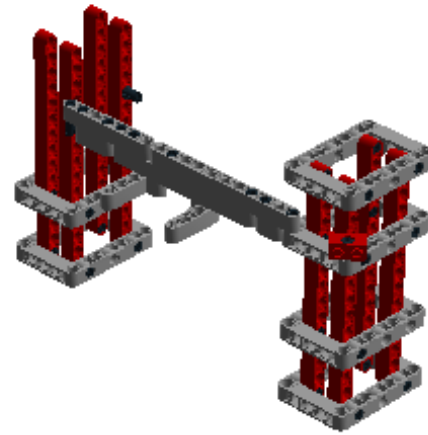

Step 131 of 278

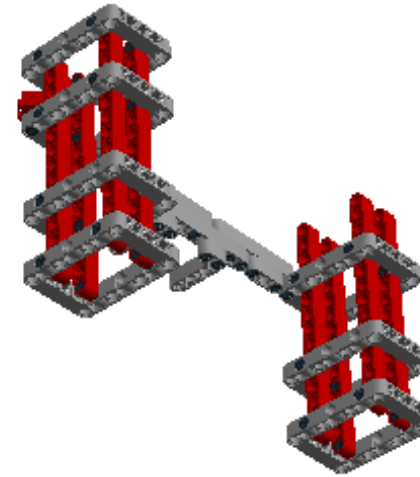
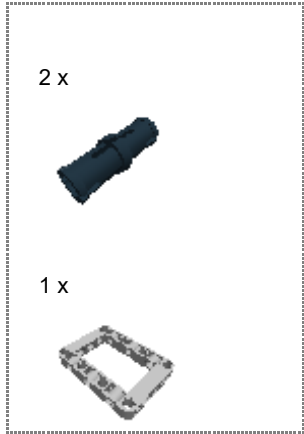

Step 132 of 278

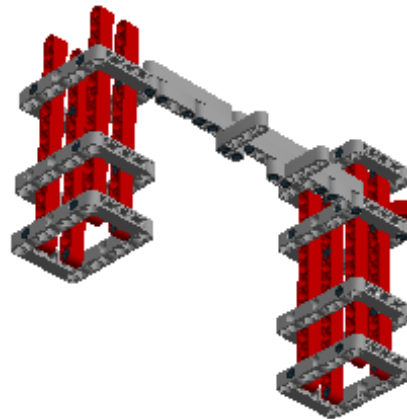

Step 133 of 278

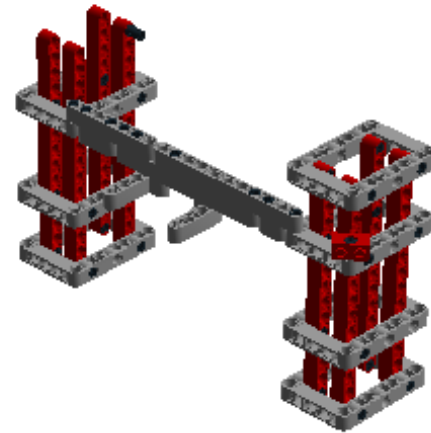

Step 134 of 278

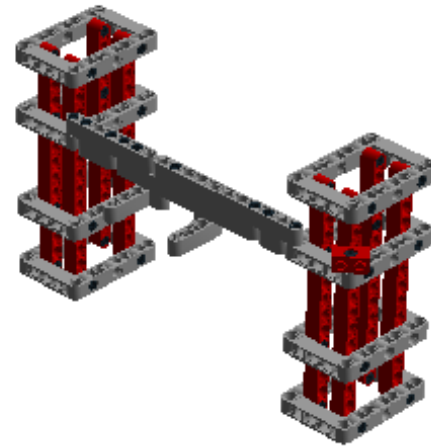
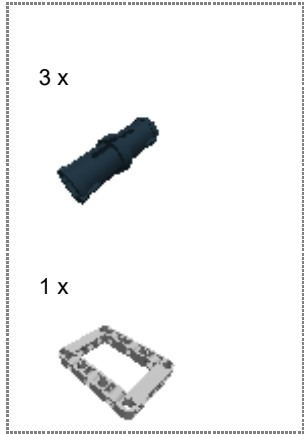

Step 135 of 278

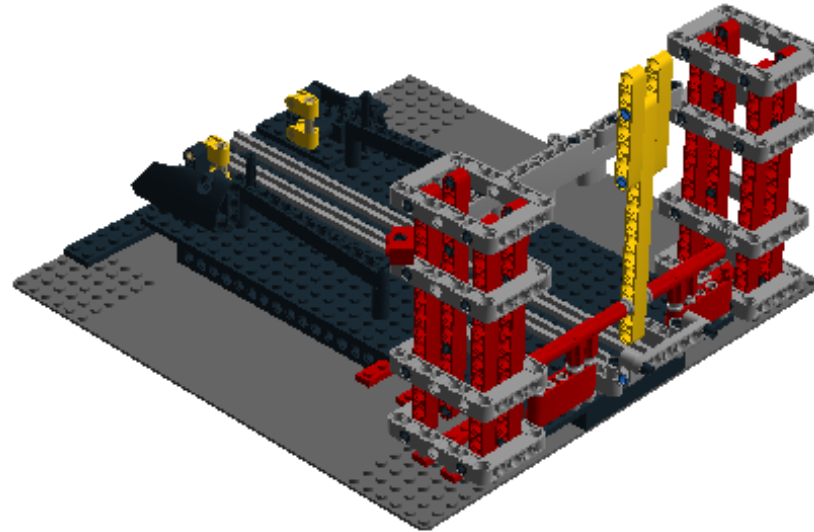

Step 136 of 278

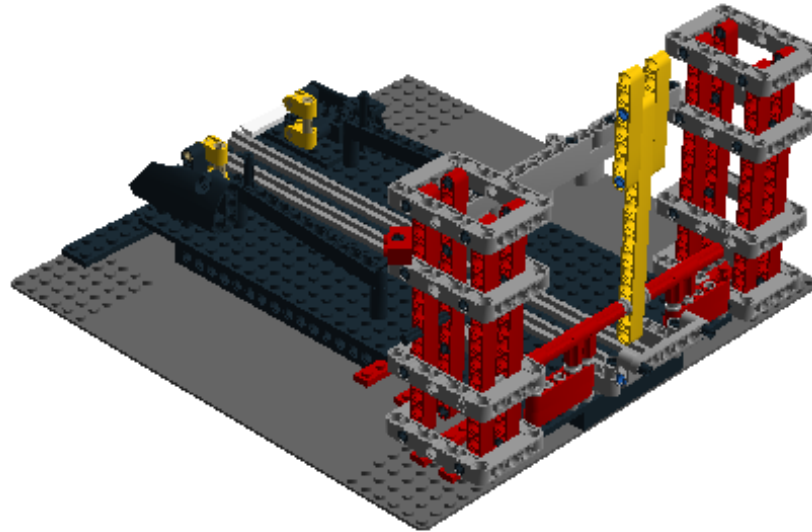
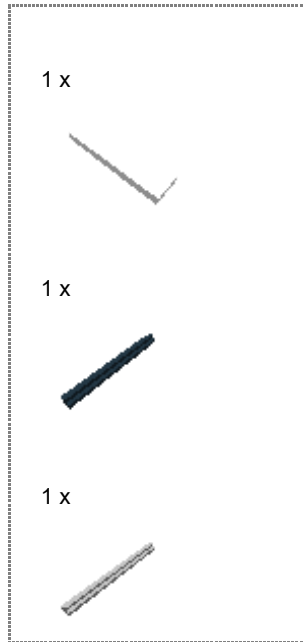

Step 137 of 278

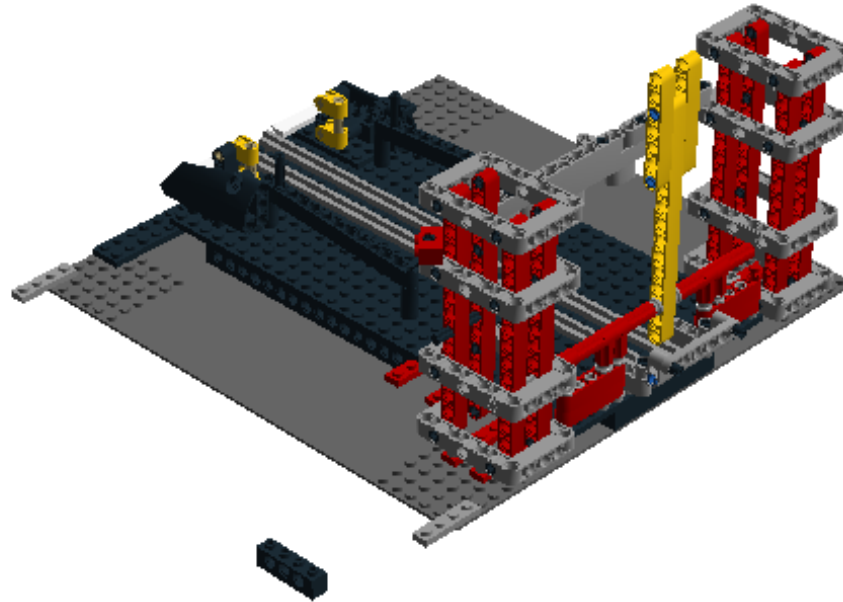
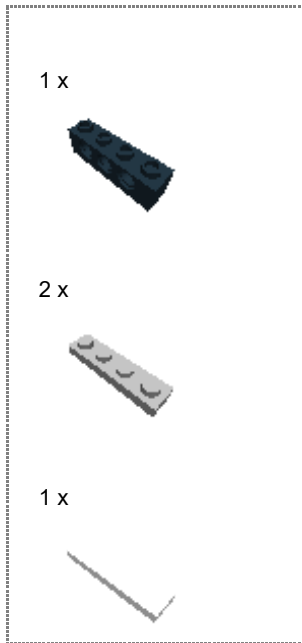

Step 138 of 278

1 x

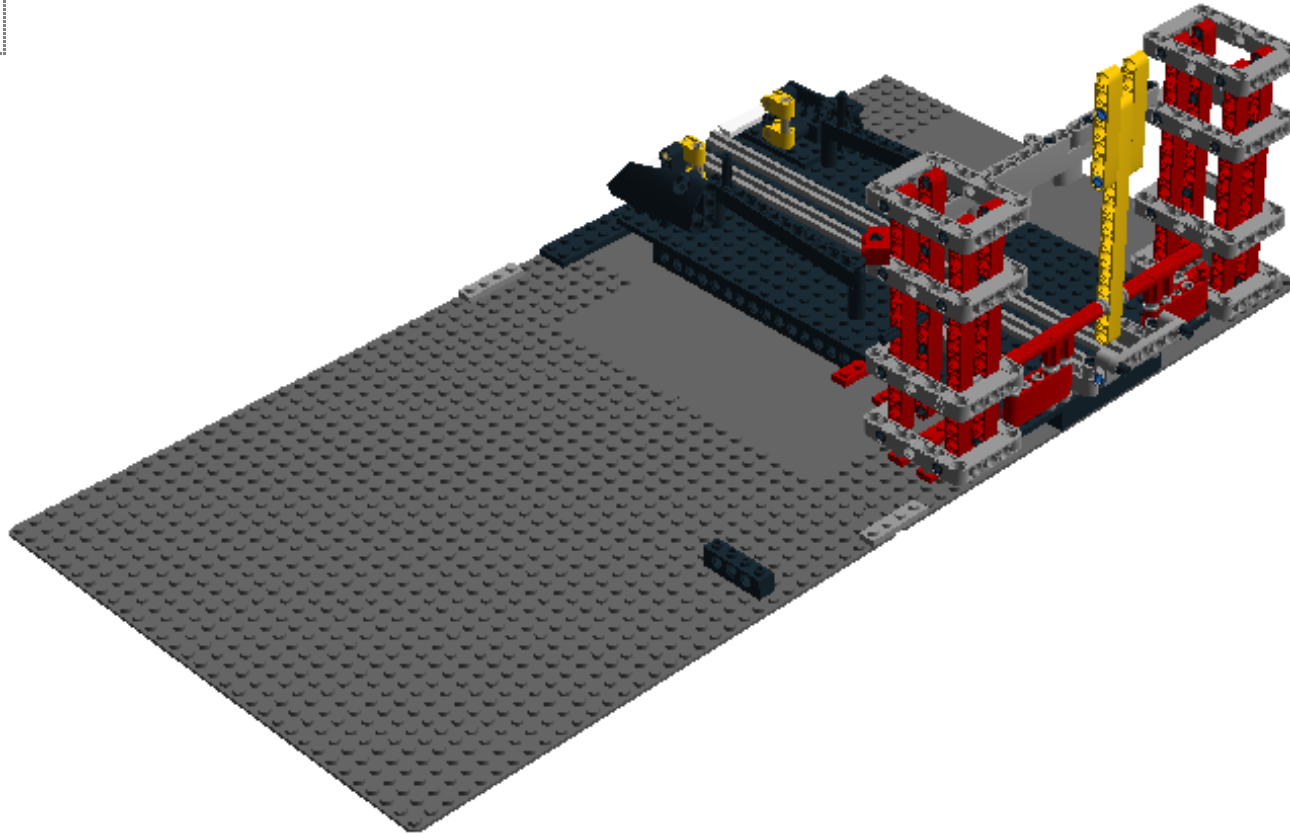

Step 139 of 278

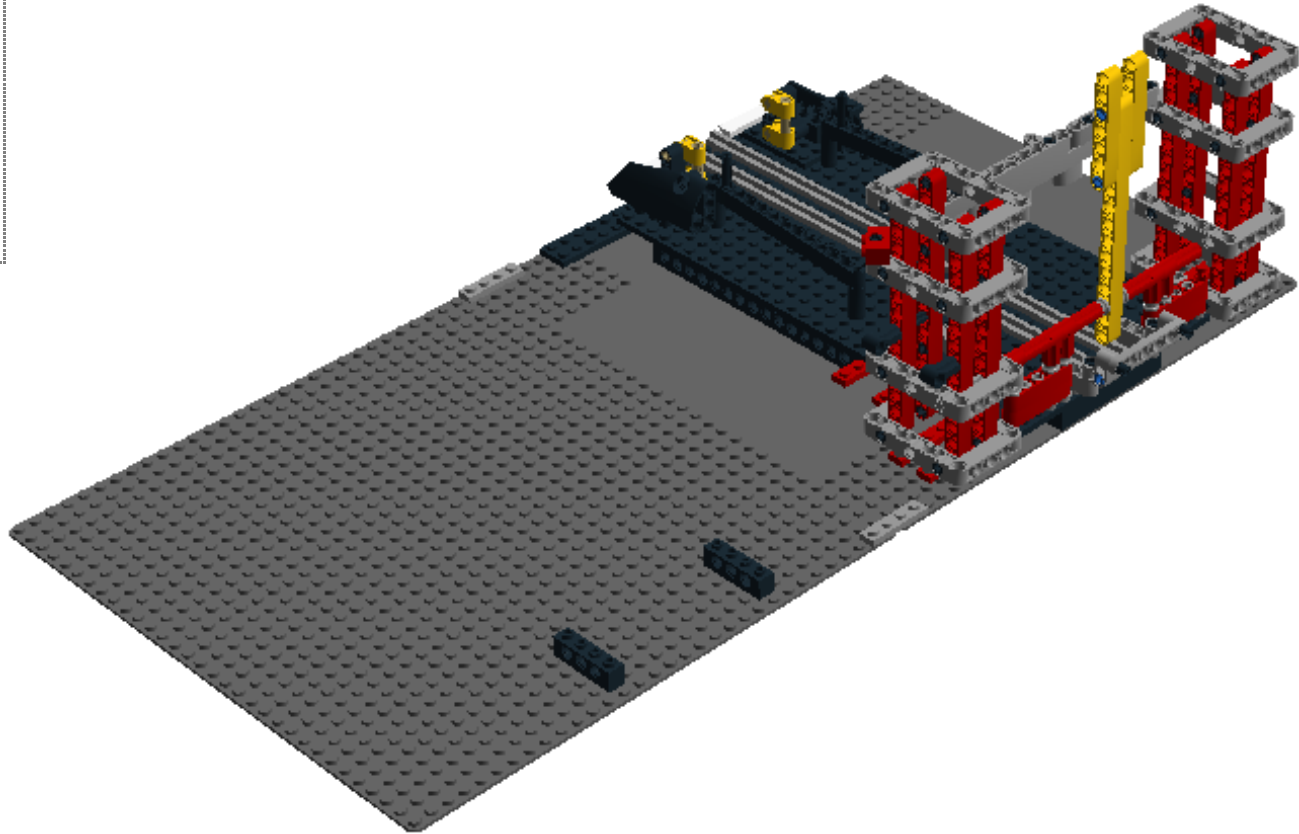
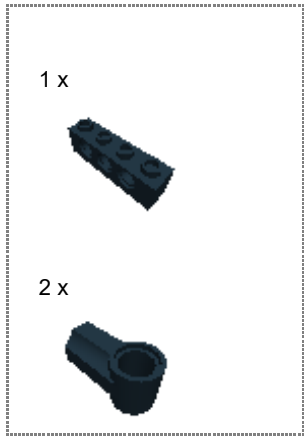

Step 140 of 278

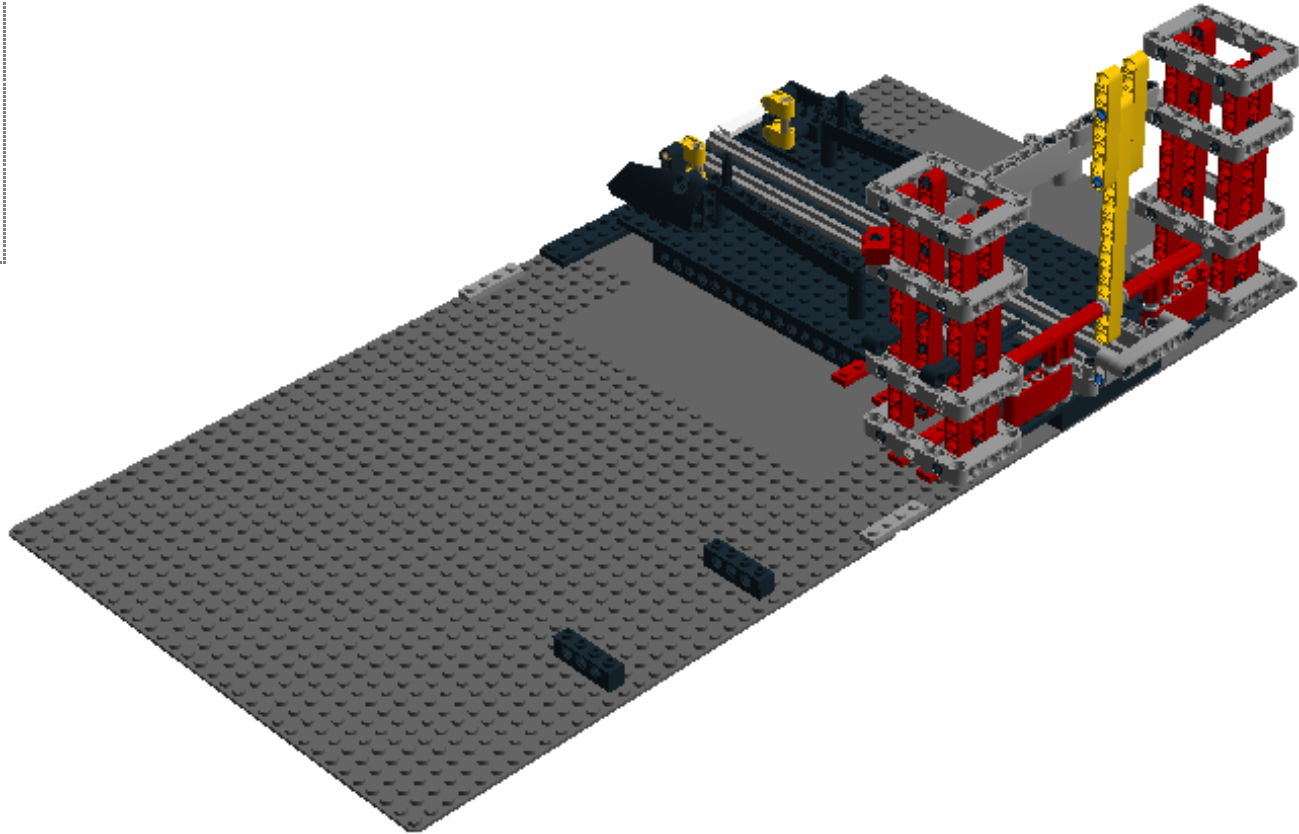
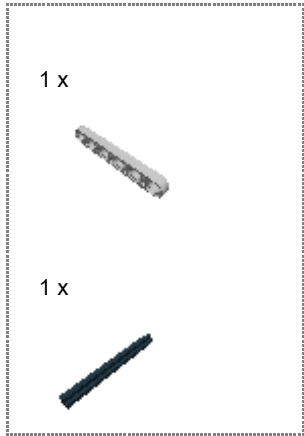

Step 141 of 278

1 x



1 x

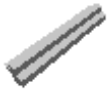

1 x



Step 142 of 278

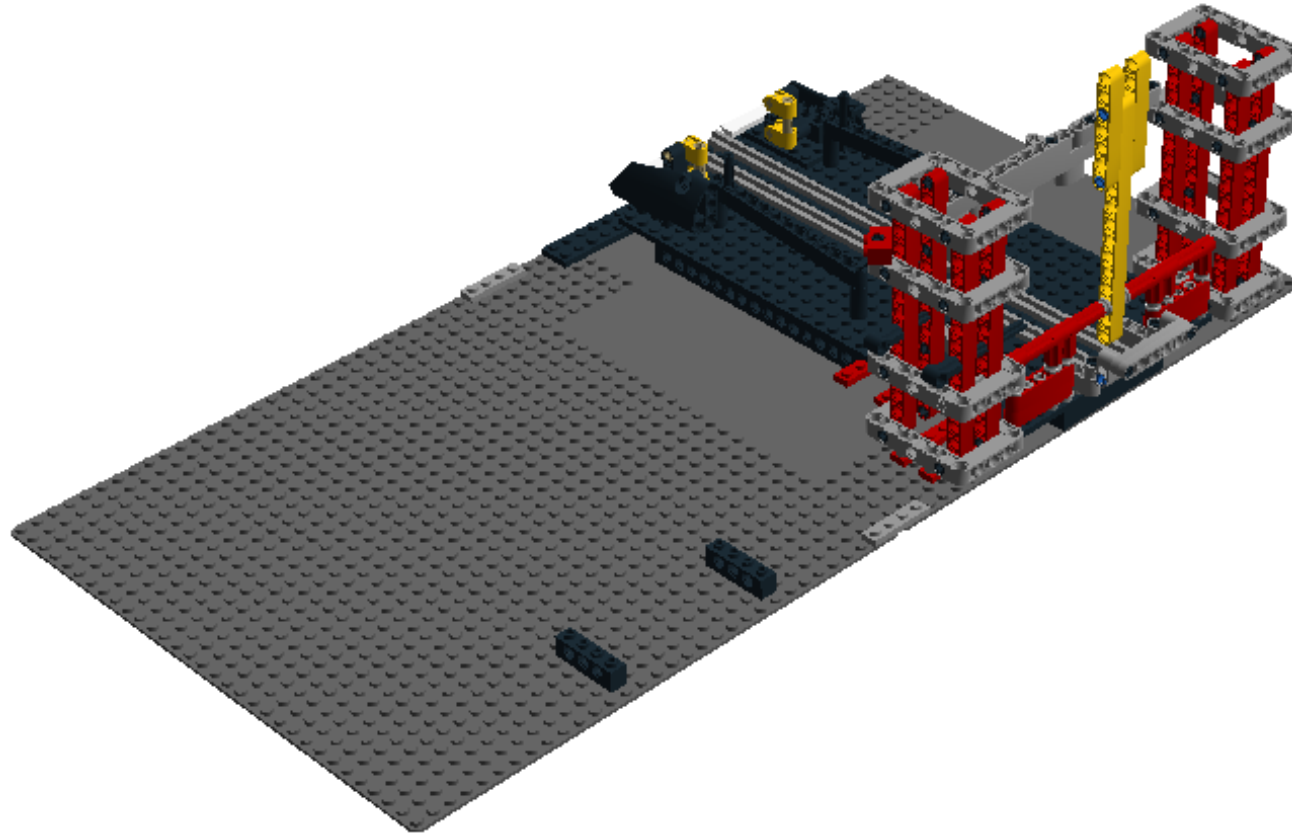

Step 143 of 278

1 x

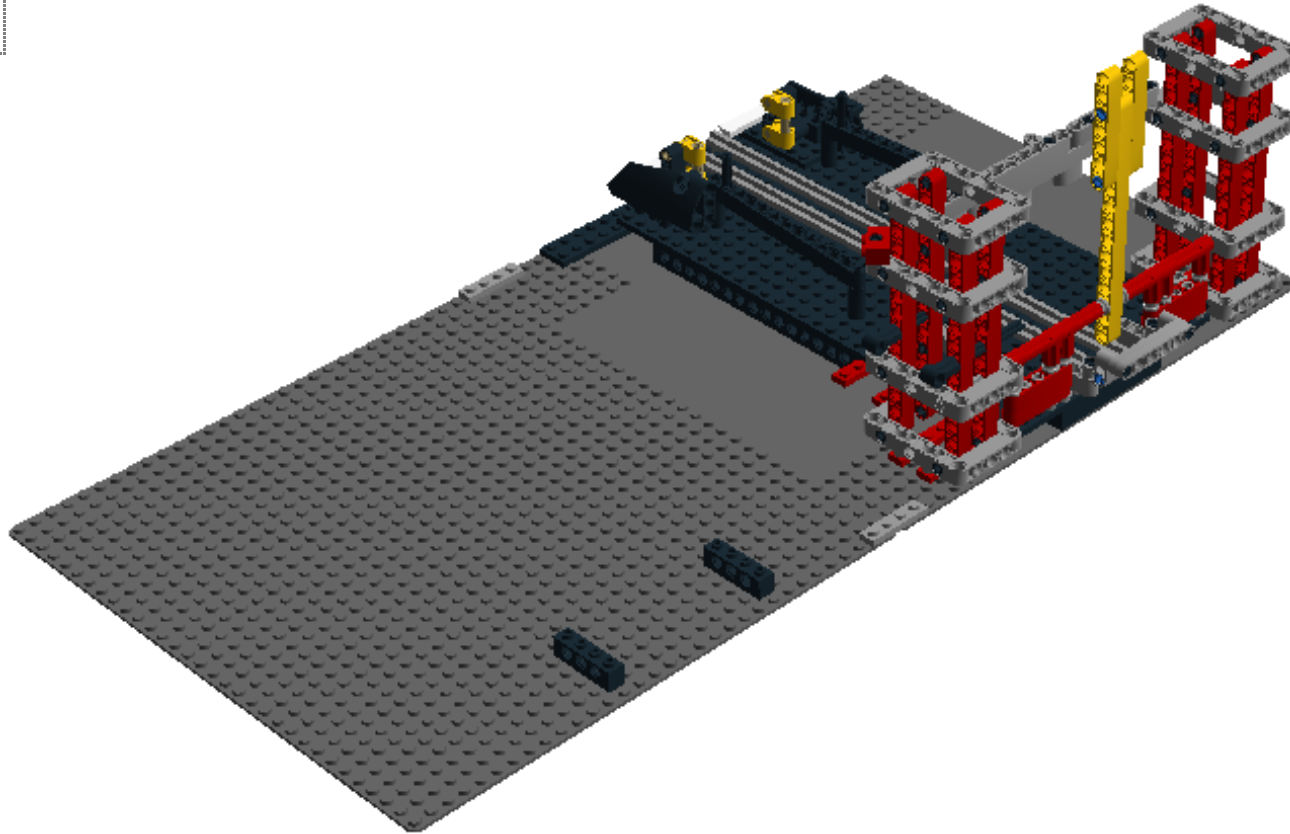

Step 144 of 278

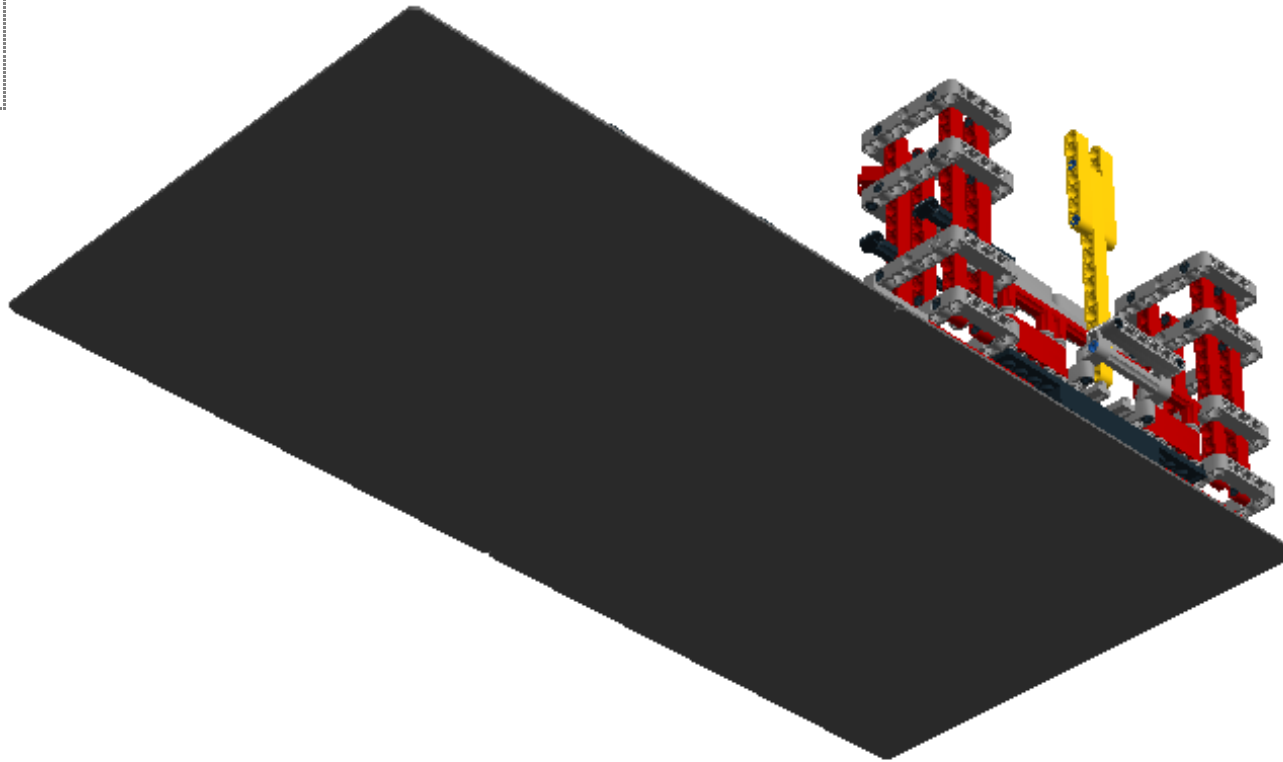
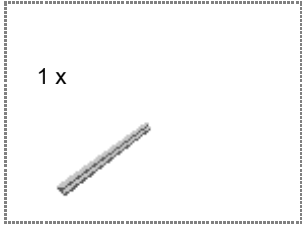

Step 145 of 278

2 x



1 x



1 x



Step 146 of 278

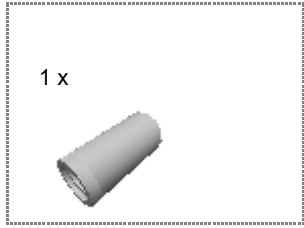

Step 147 of 278

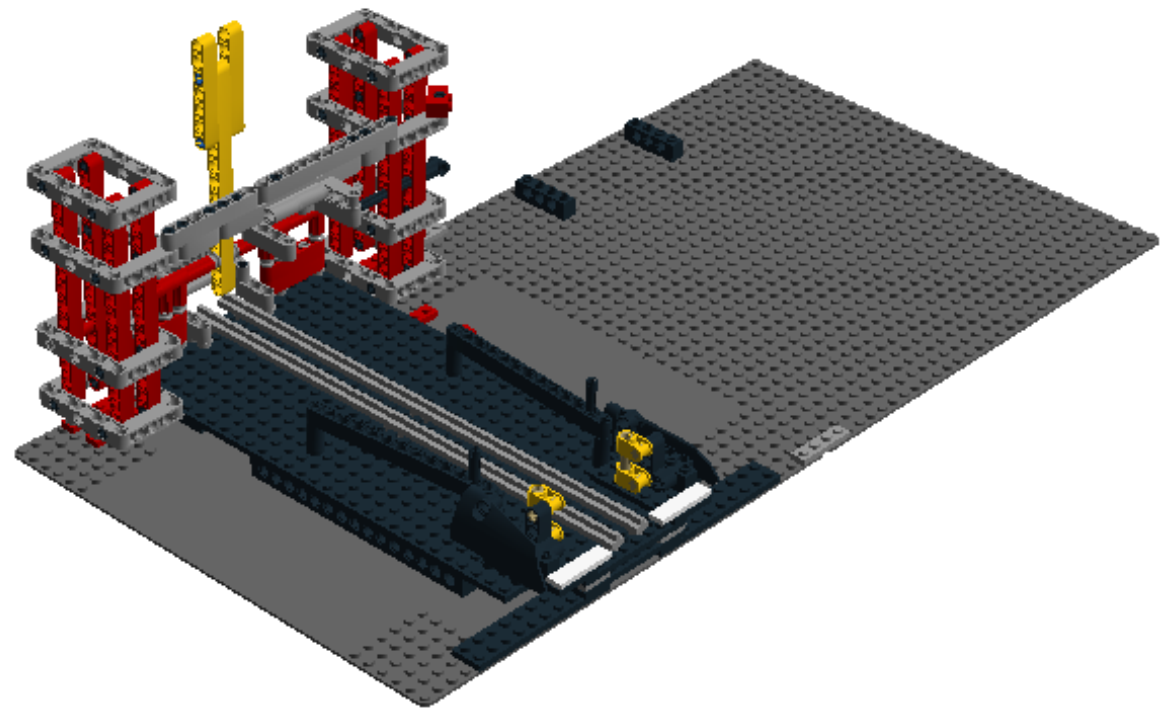

Step 148 of 278

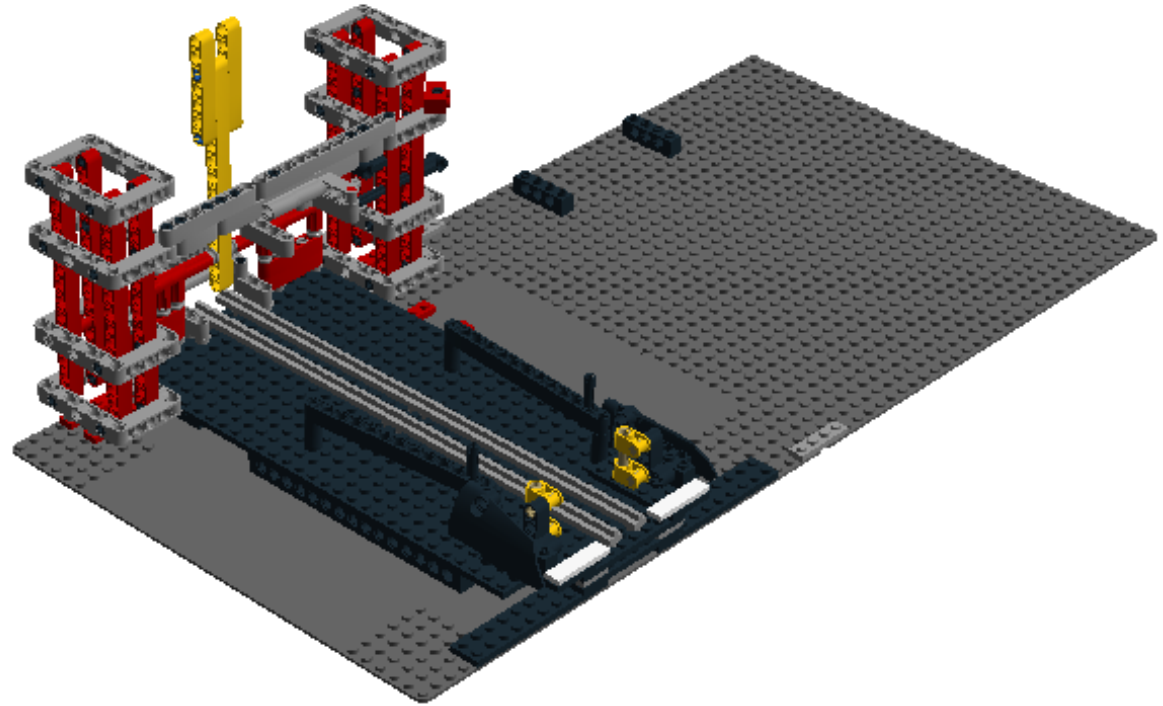
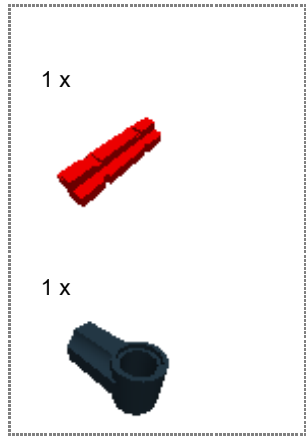

Step 149 of 278

1 x



1 x



2 x

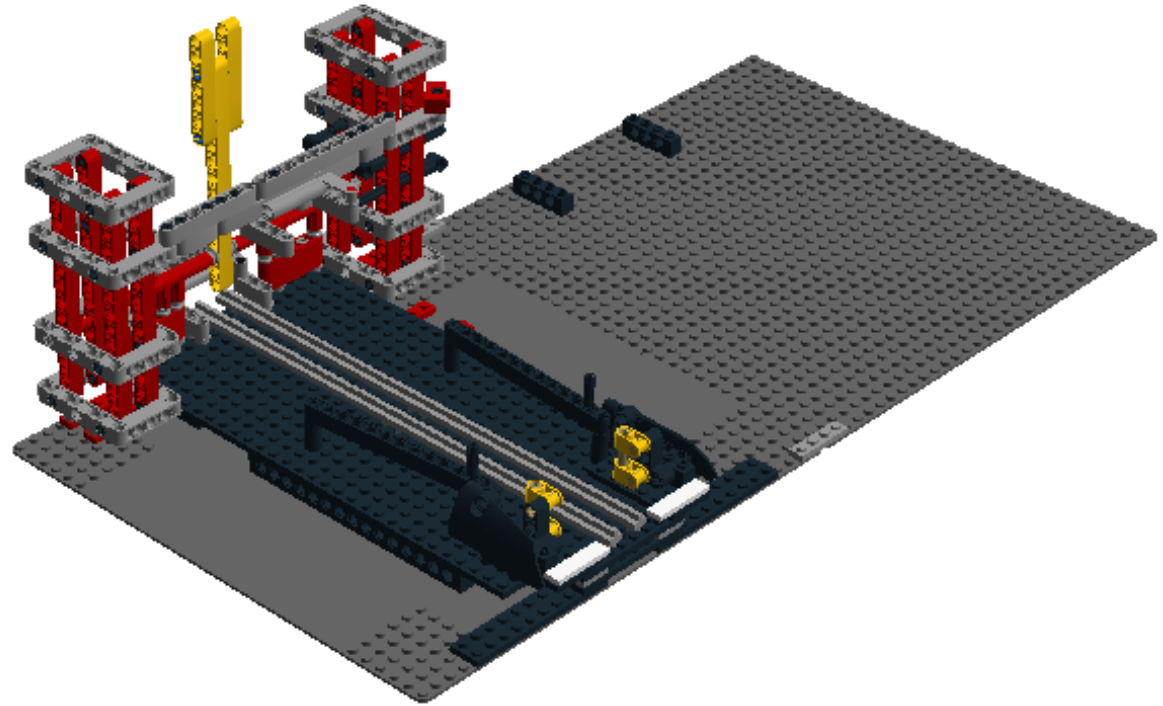

Step 150 of 278

1 x



1 x



1 x



1 x

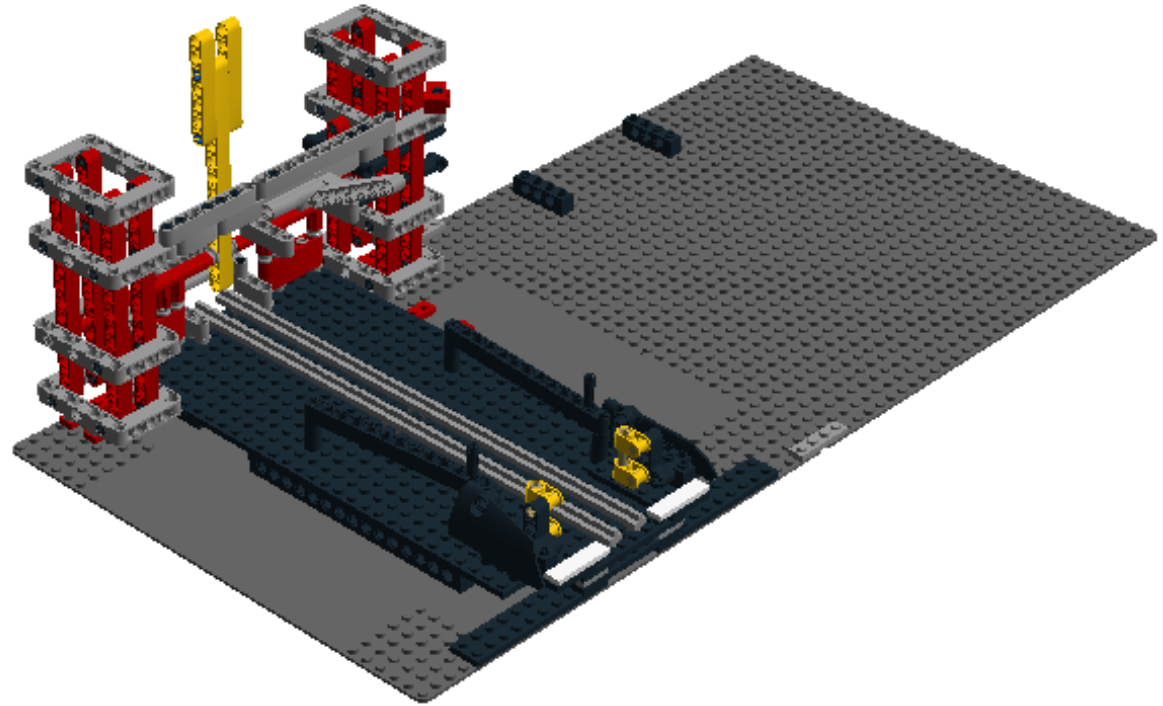

Step 151 of 278

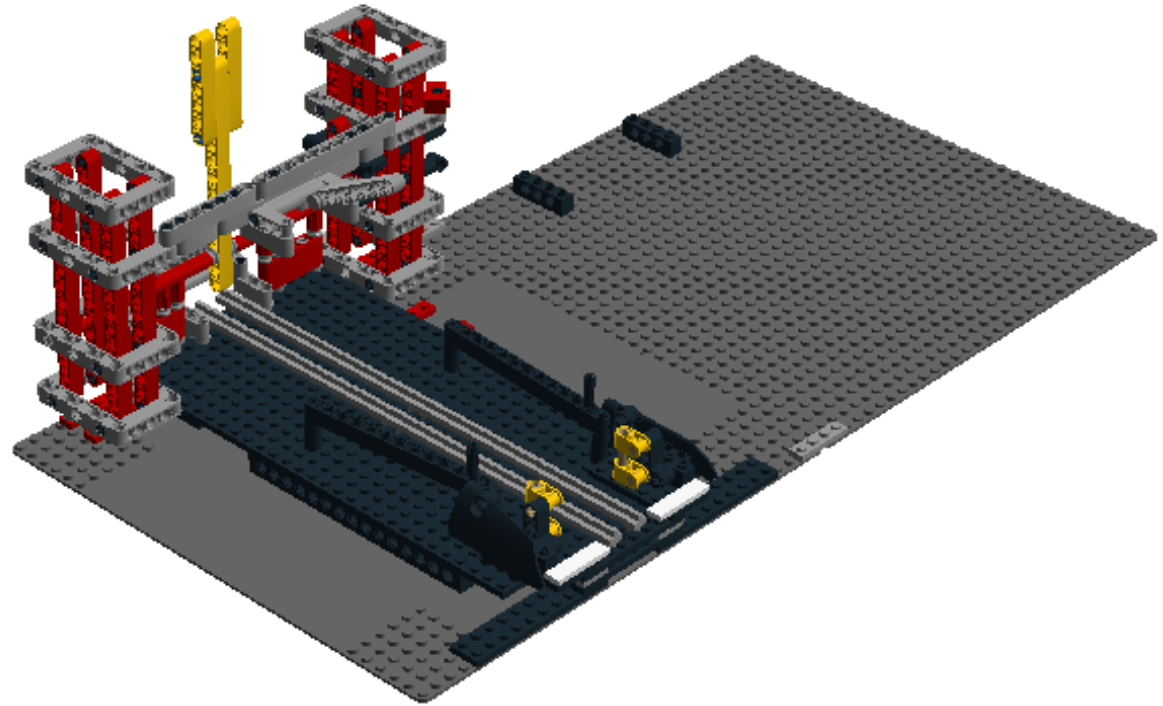
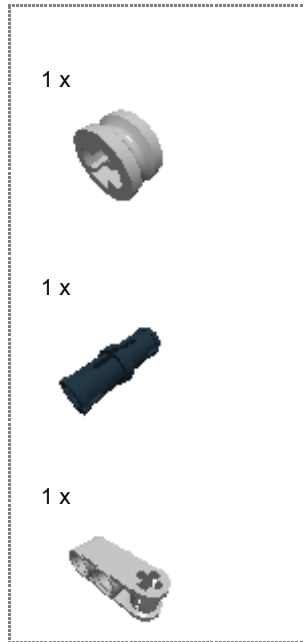

Step 152 of 278

1 x

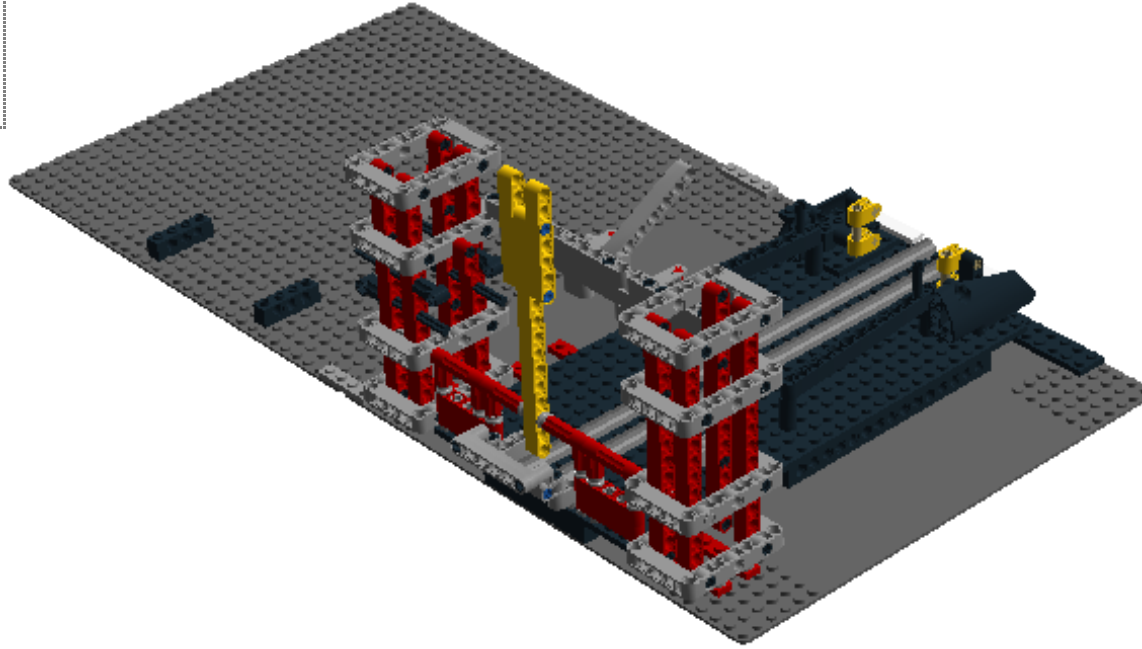

Step 153 of 278

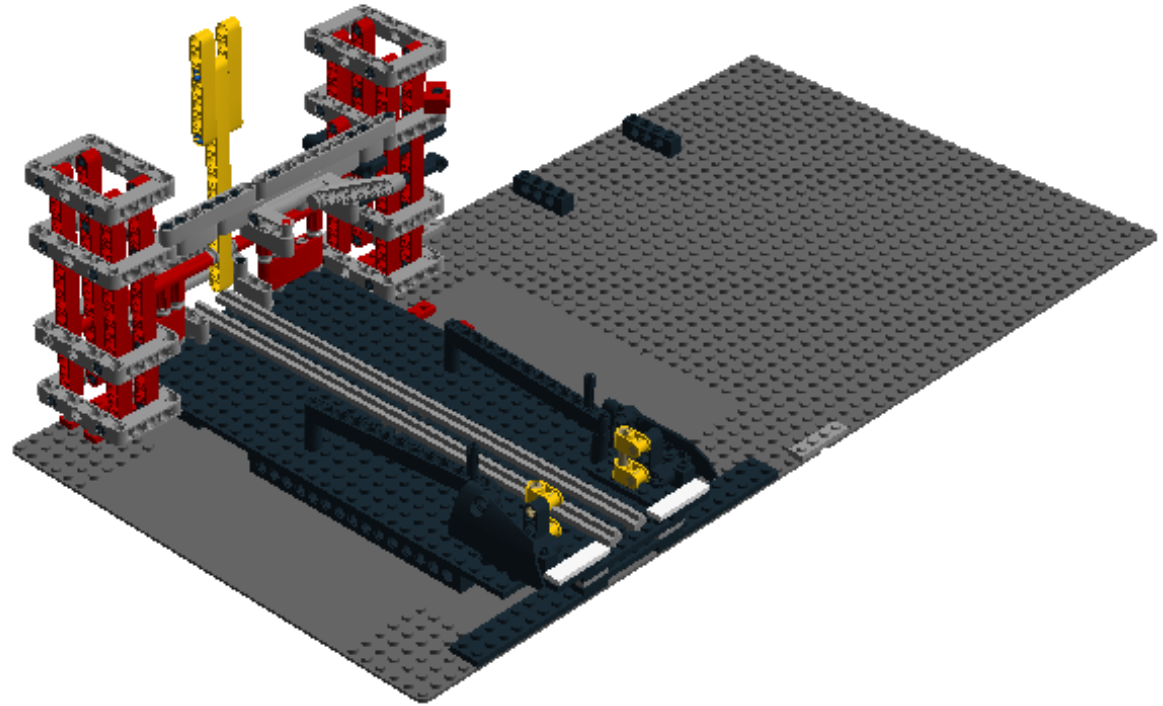
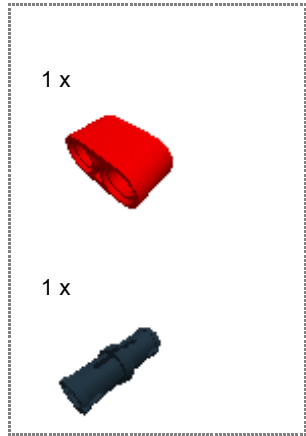

Step 154 of 278

1 x



Step 155 of 278

1 x



1 x



1 x



1 x



Step 156 of 278

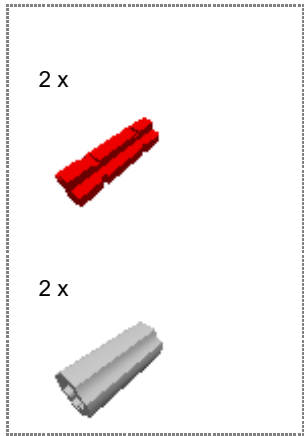

Step 157 of 278

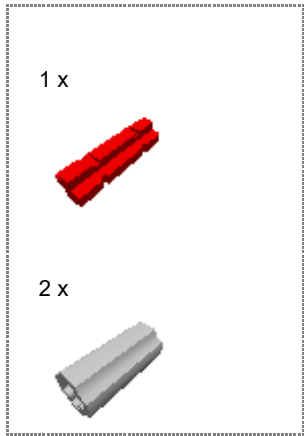

Step 158 of 278

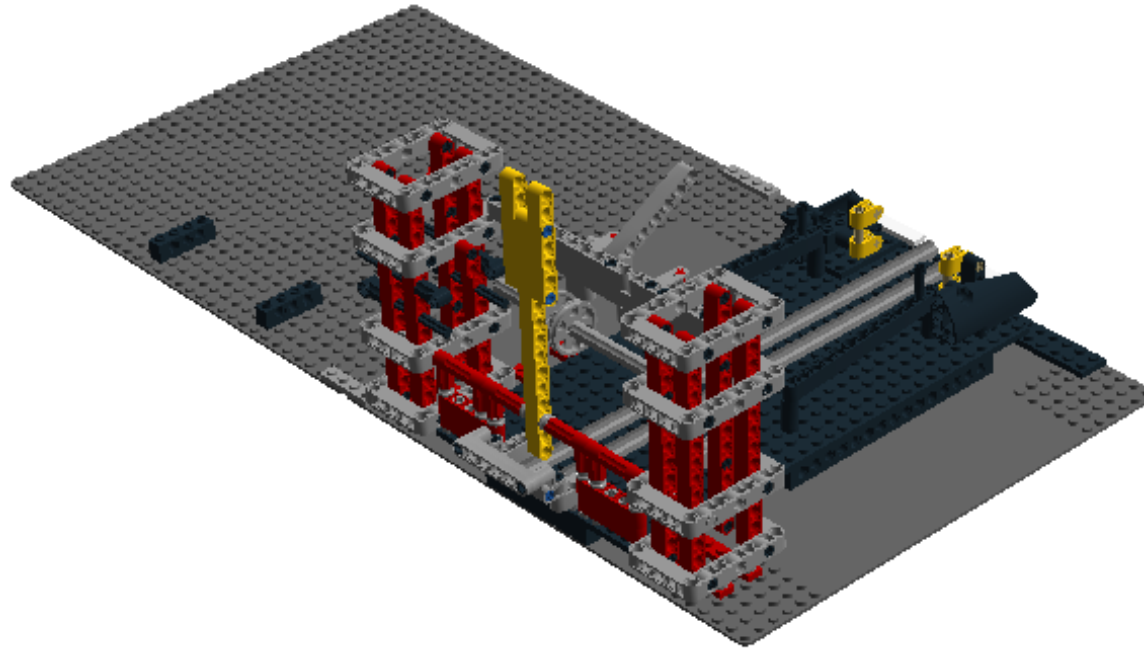

Step 159 of 278

1 x



1 x



1 x



Step 160 of 278

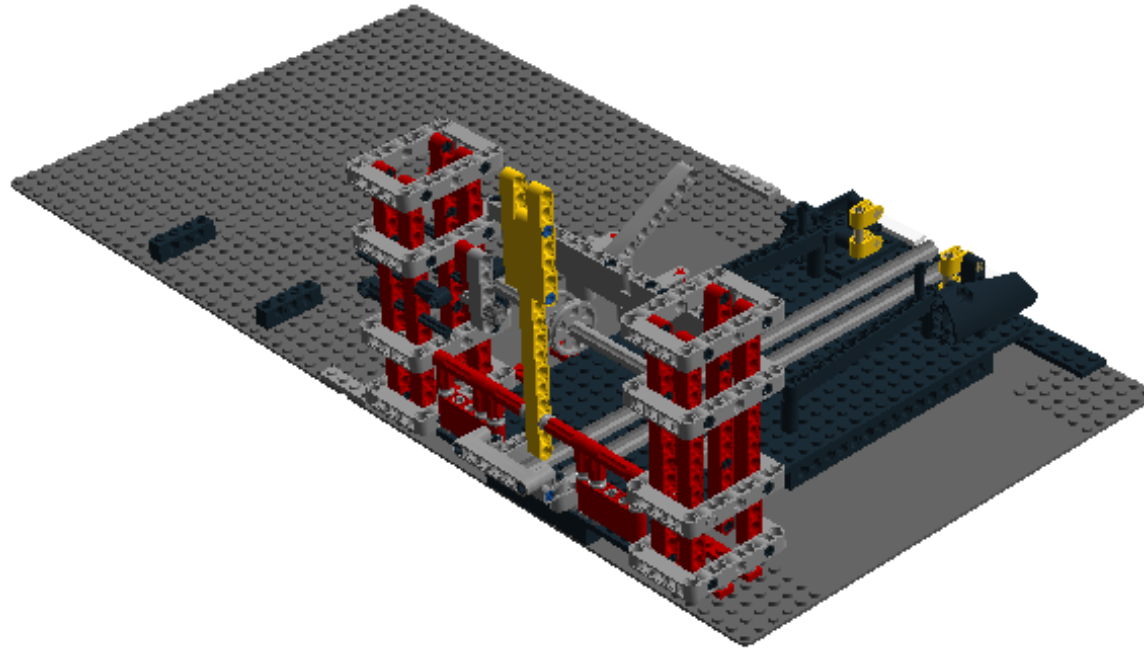

Step 161 of 278

1 x

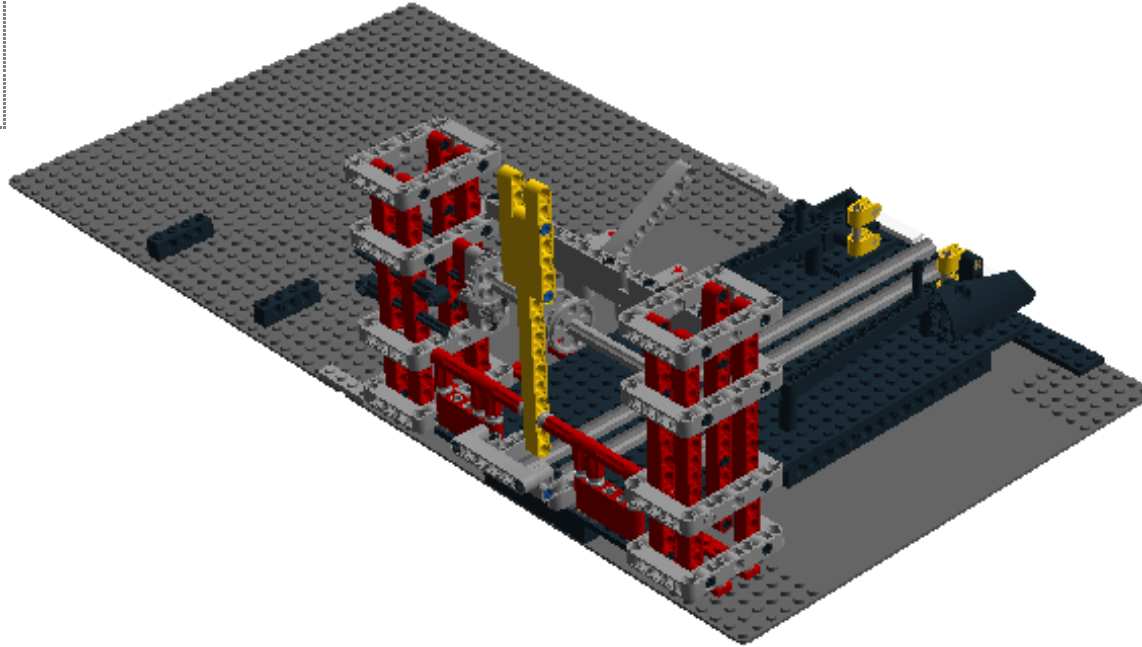

Step 162 of 278

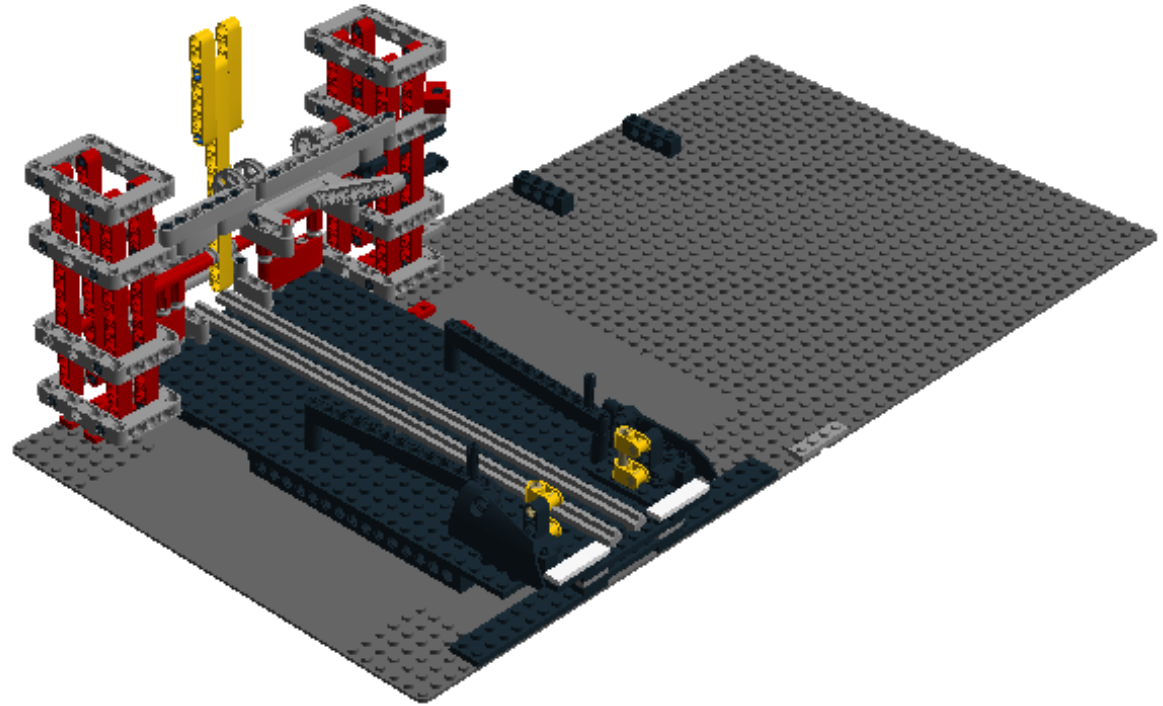
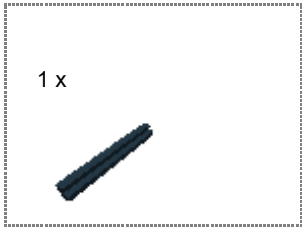

Step 163 of 278

1 x

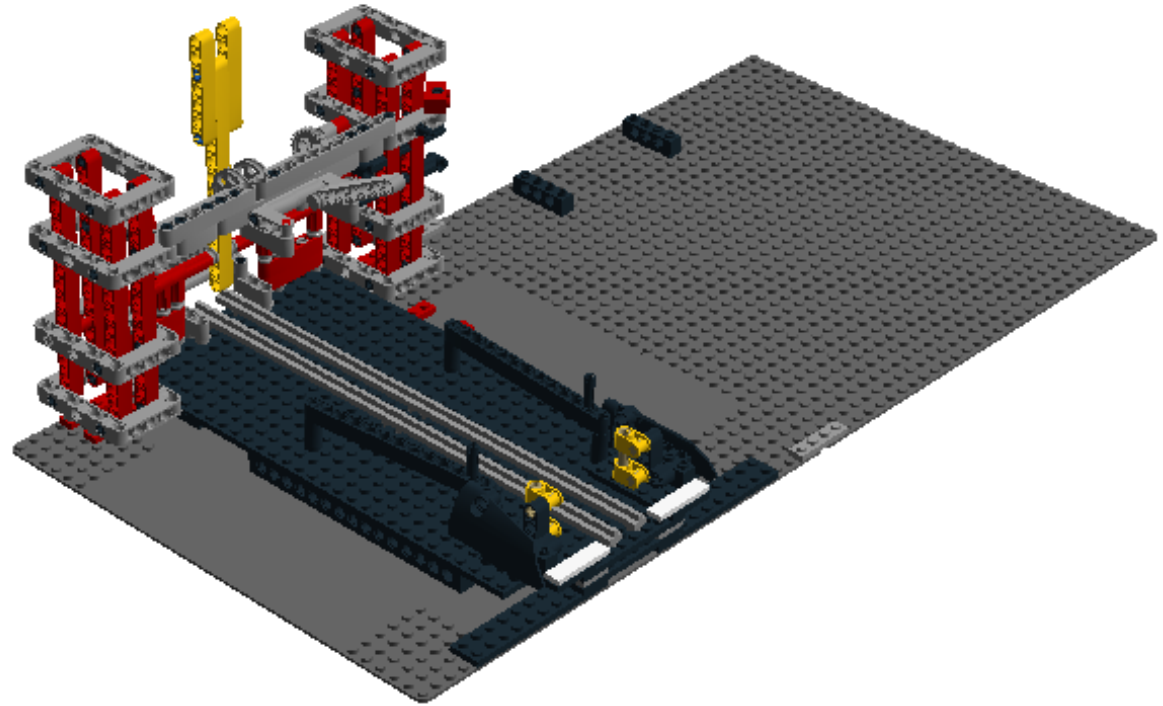

Step 164 of 278

1 x



3 x

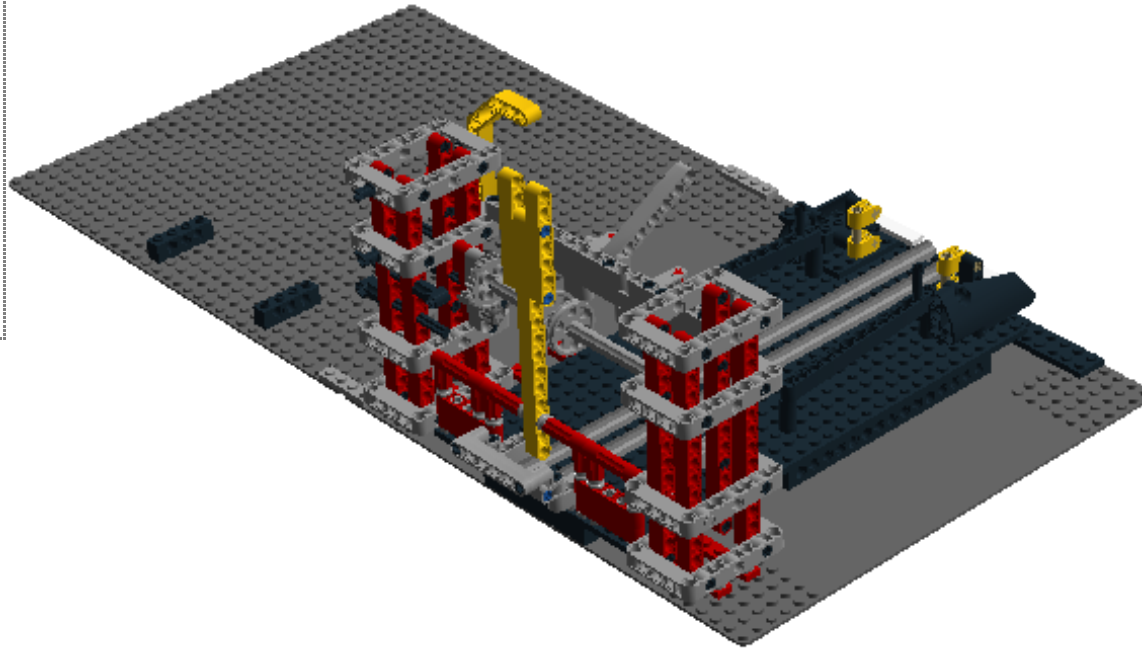

Step 165 of 278

1 x



1 x



1 x

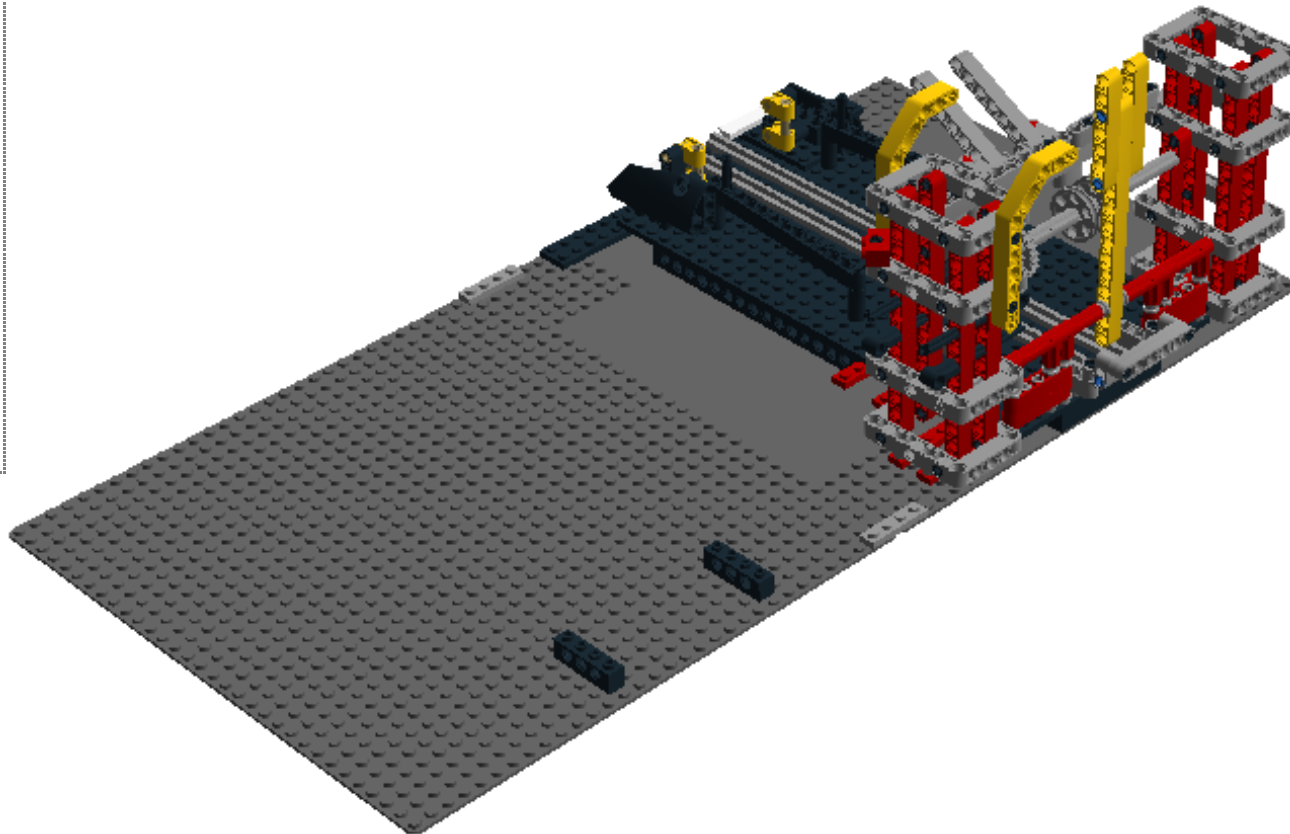

Step 166 of 278

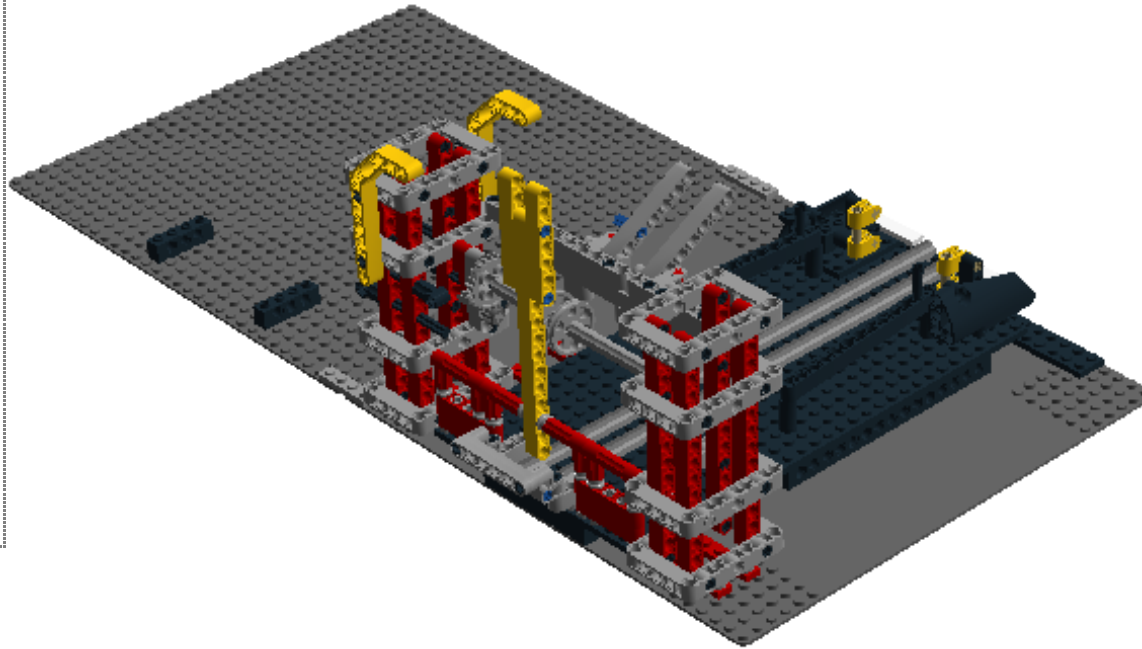
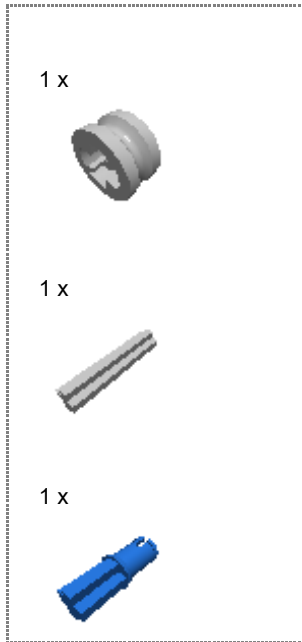

Step 167 of 278

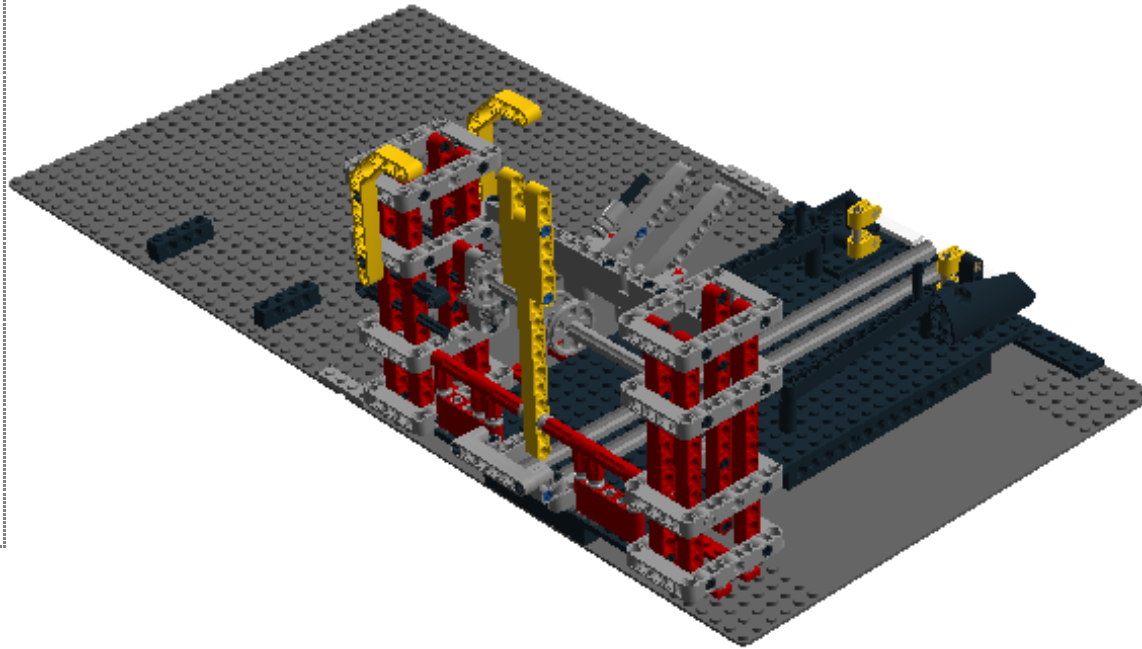
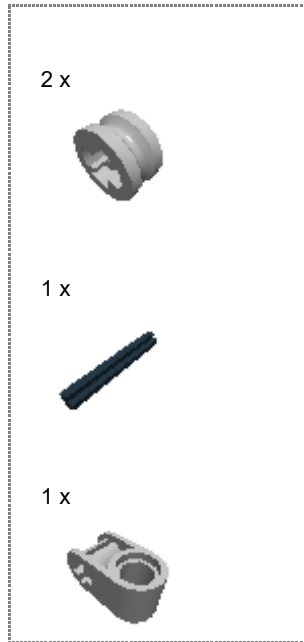

Step 168 of 278

1 x



1 x



2 x

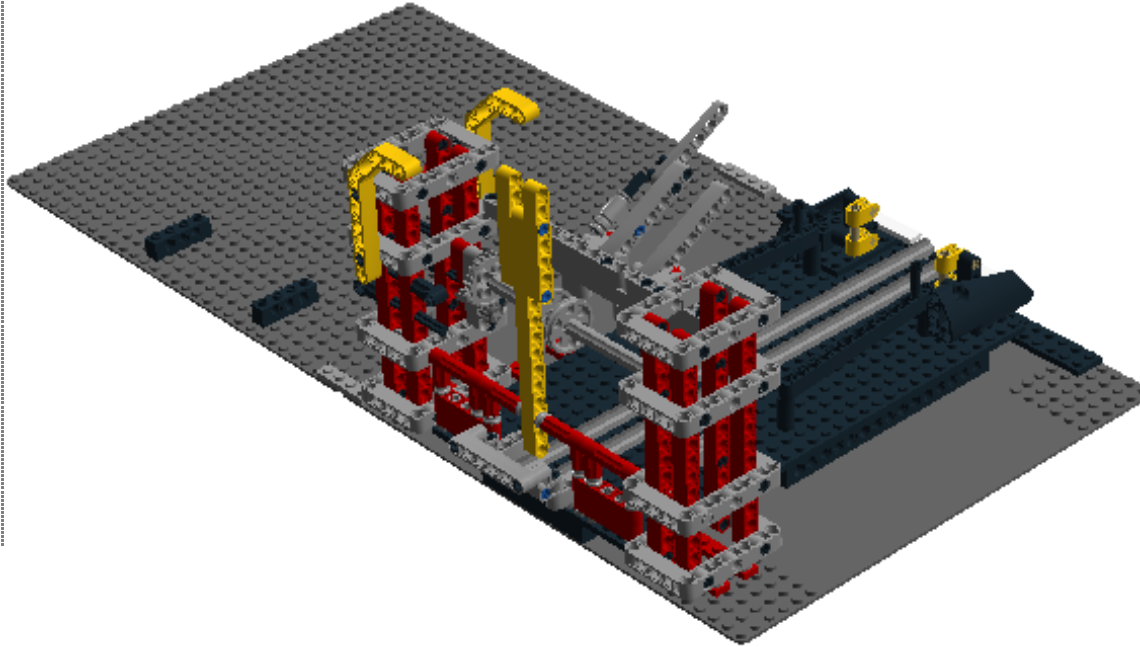

Step 169 of 278

1 x



1 x



1 x



1 x

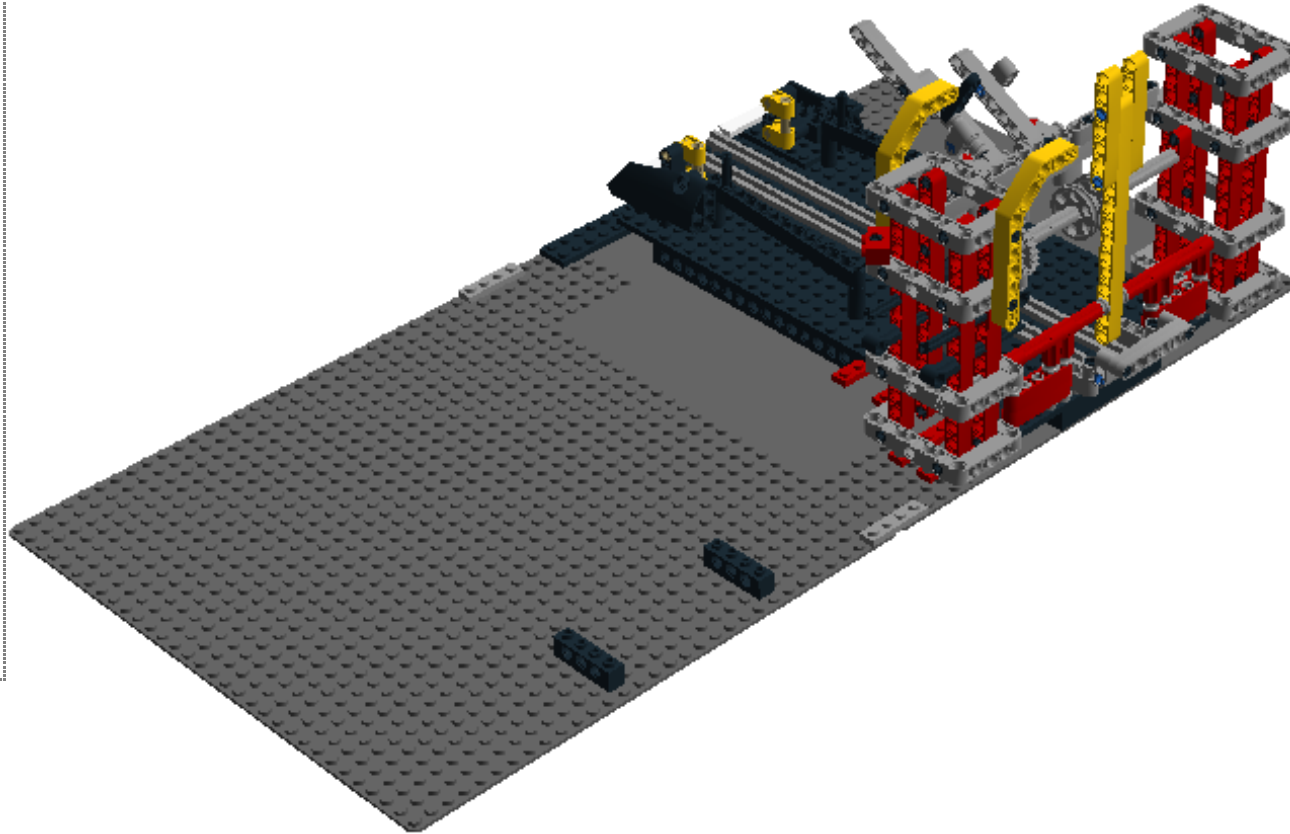

Step 170 of 278

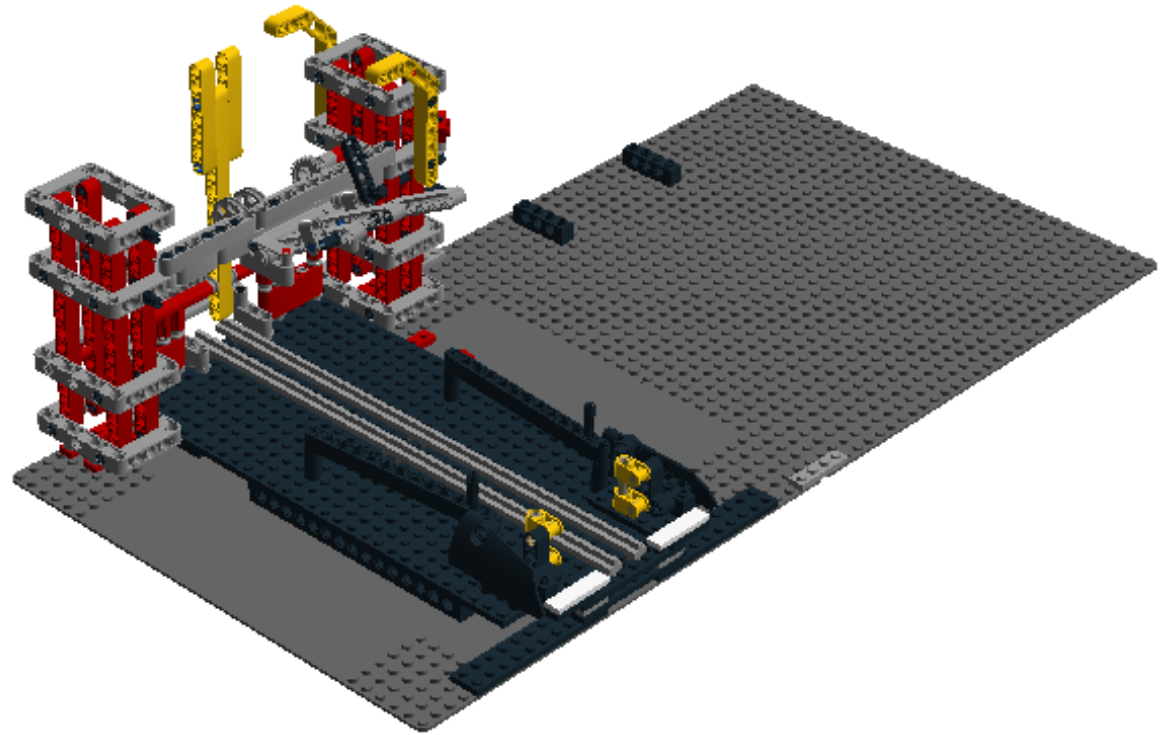
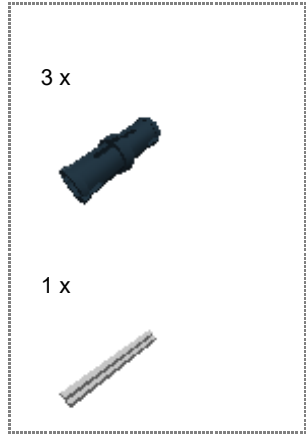

Step 171 of 278

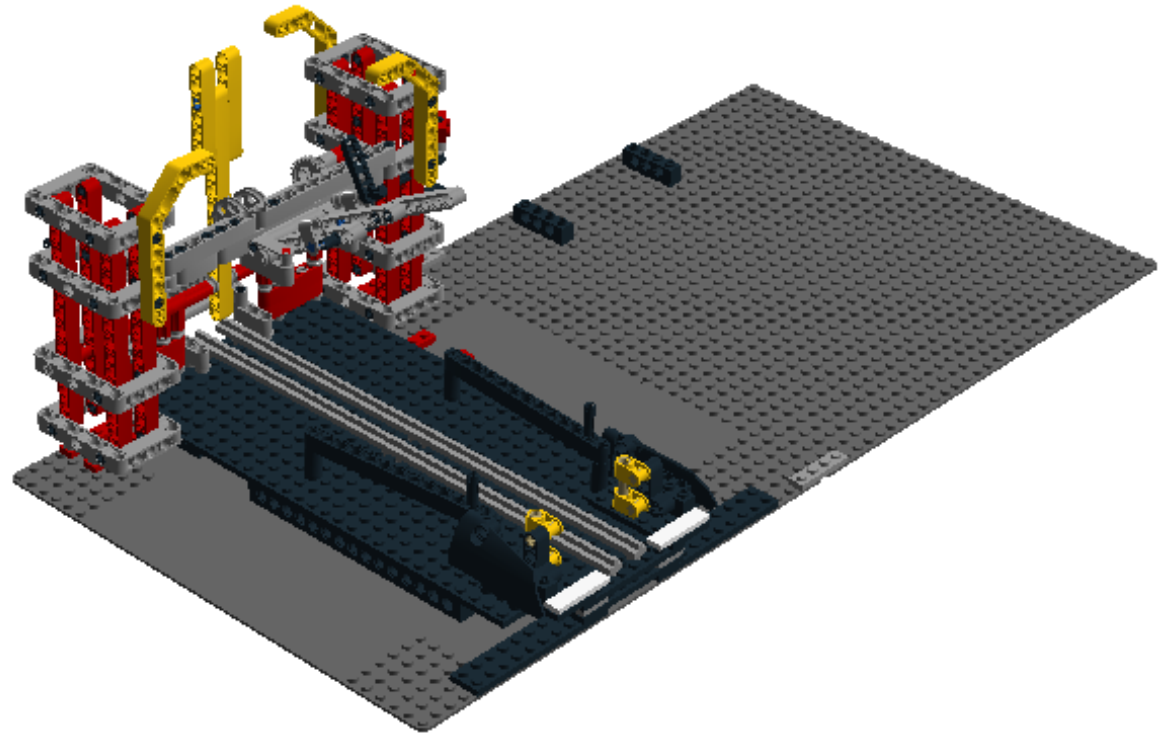
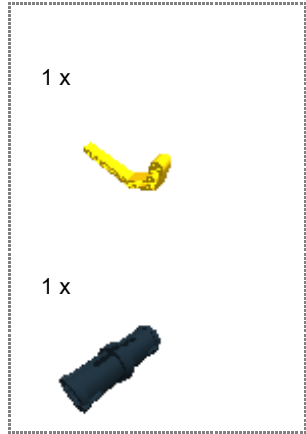

Step 172 of 278

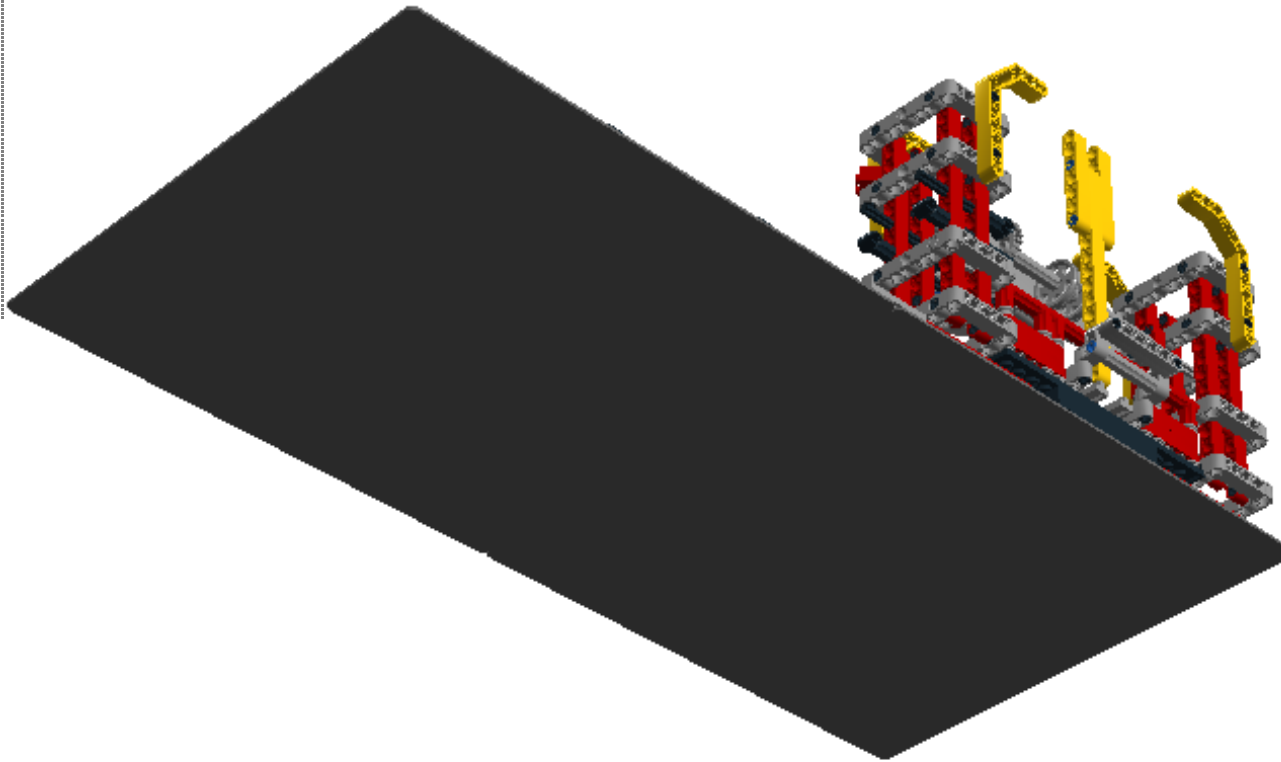
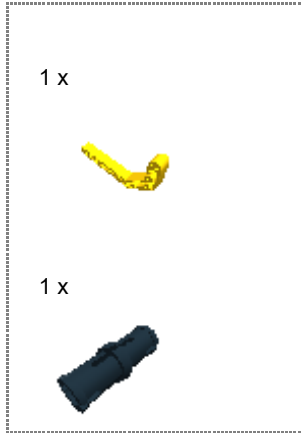

Step 173 of 278

2 x



1 x



1 x

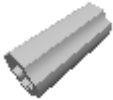

Step 174 of 278

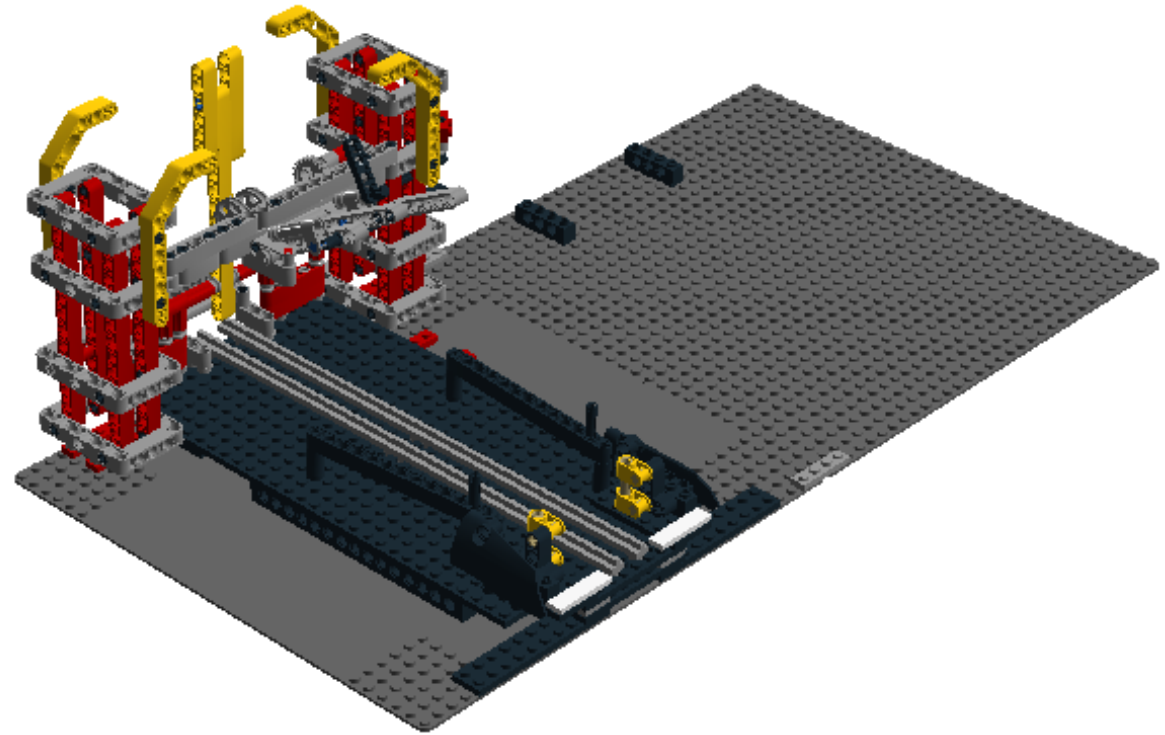

Step 175 of 278

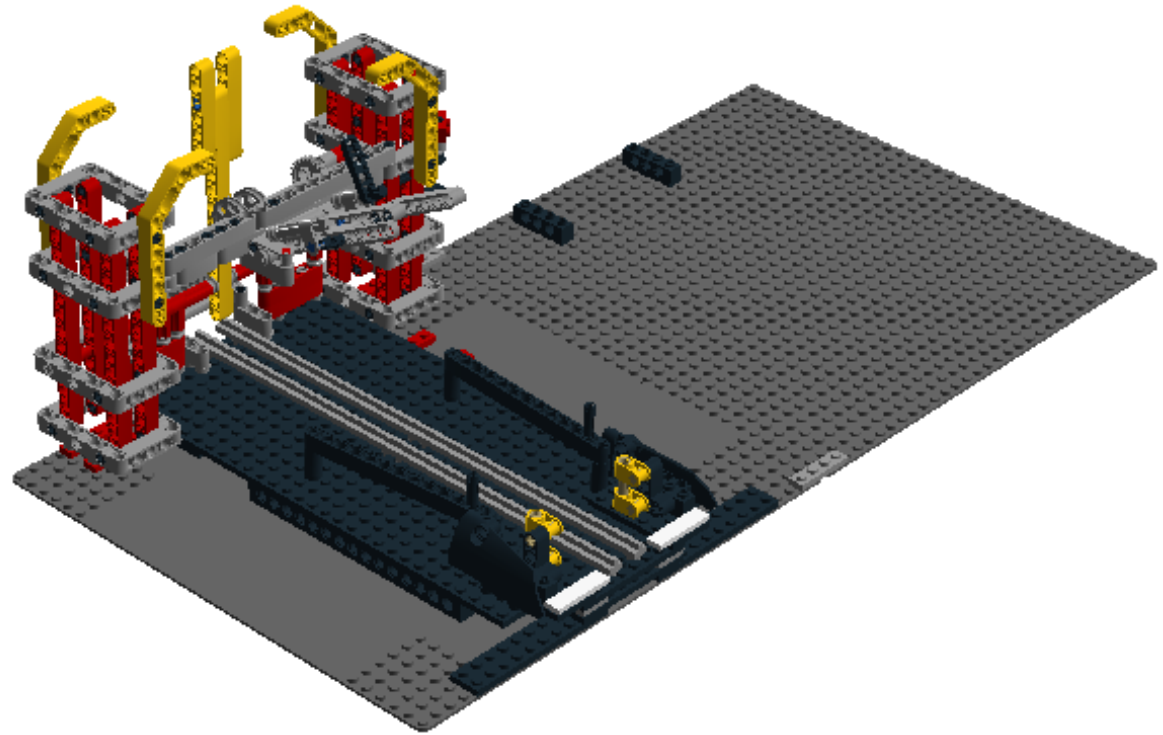

Step 176 of 278

1 x



1 x



1 x



1 x

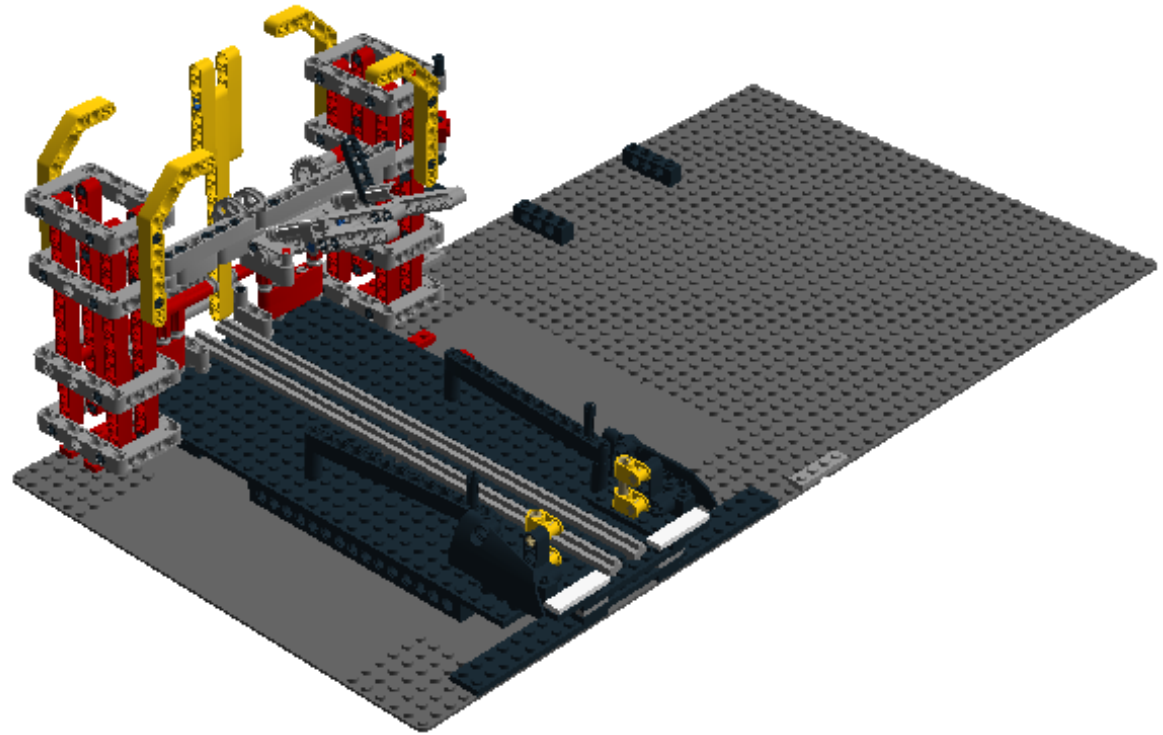

Step 177 of 278

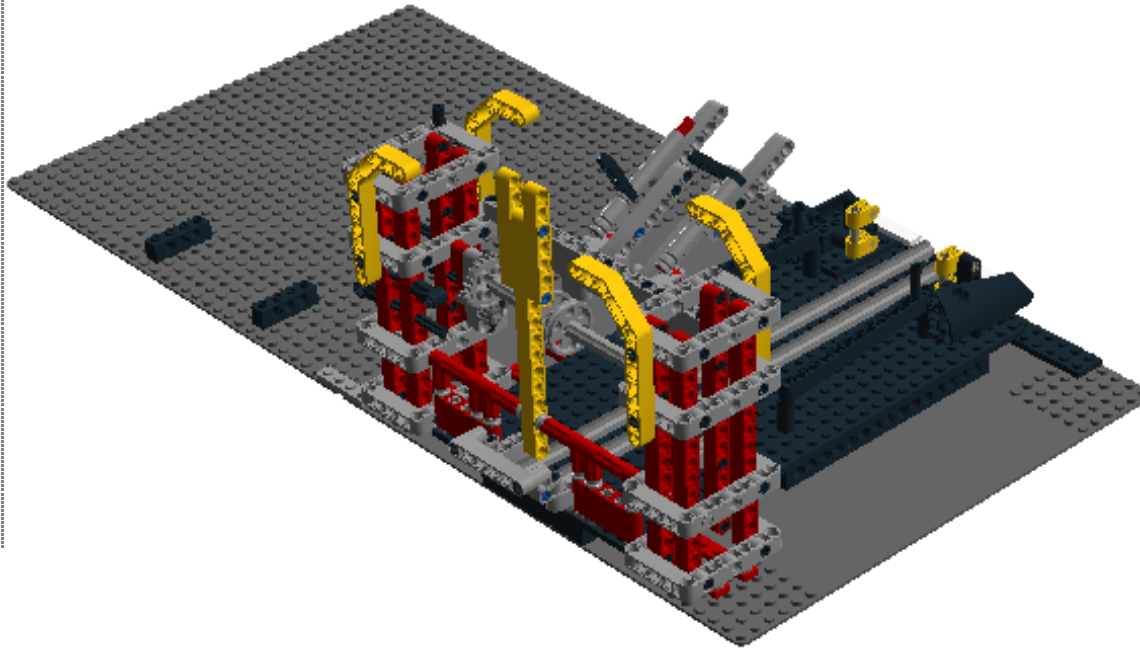
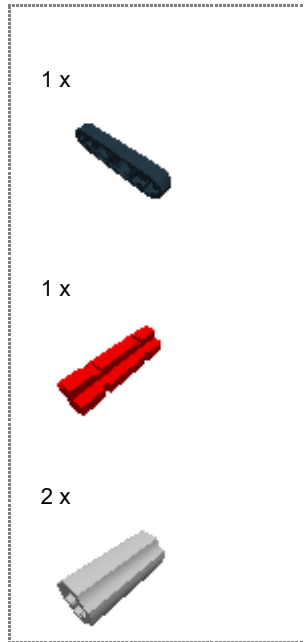

Step 178 of 278

1 x



1 x

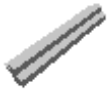

2 x

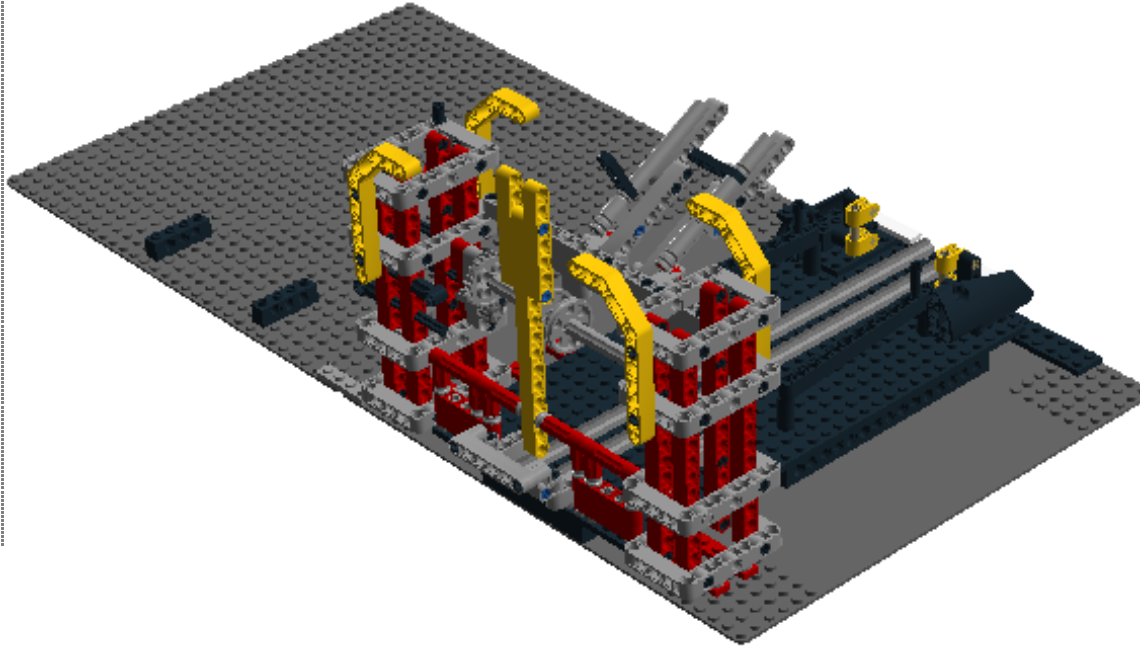

Step 179 of 278

1 x

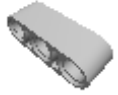

3 x



Step 180 of 278

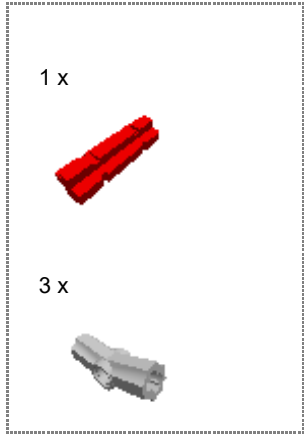

Step 181 of 278

1 x



Step 182 of 278

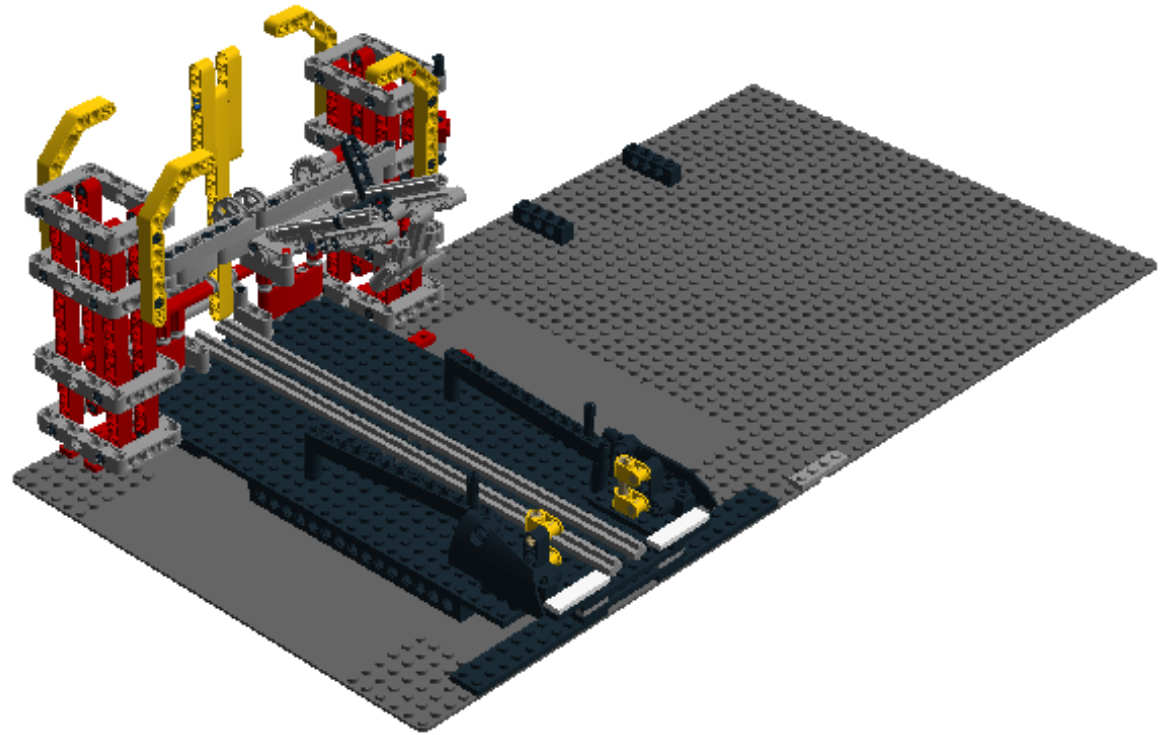

Step 183 of 278

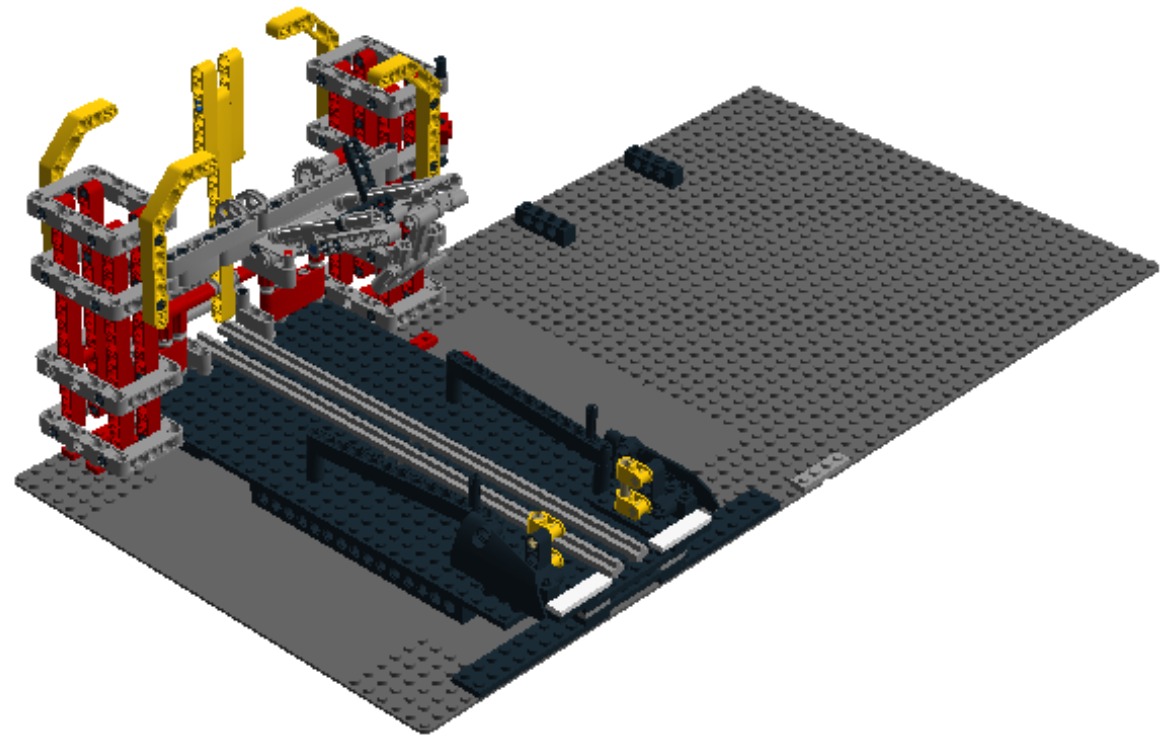
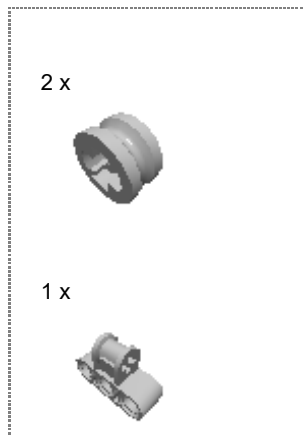

Step 184 of 278

1 x



1 x



1 x



1 x

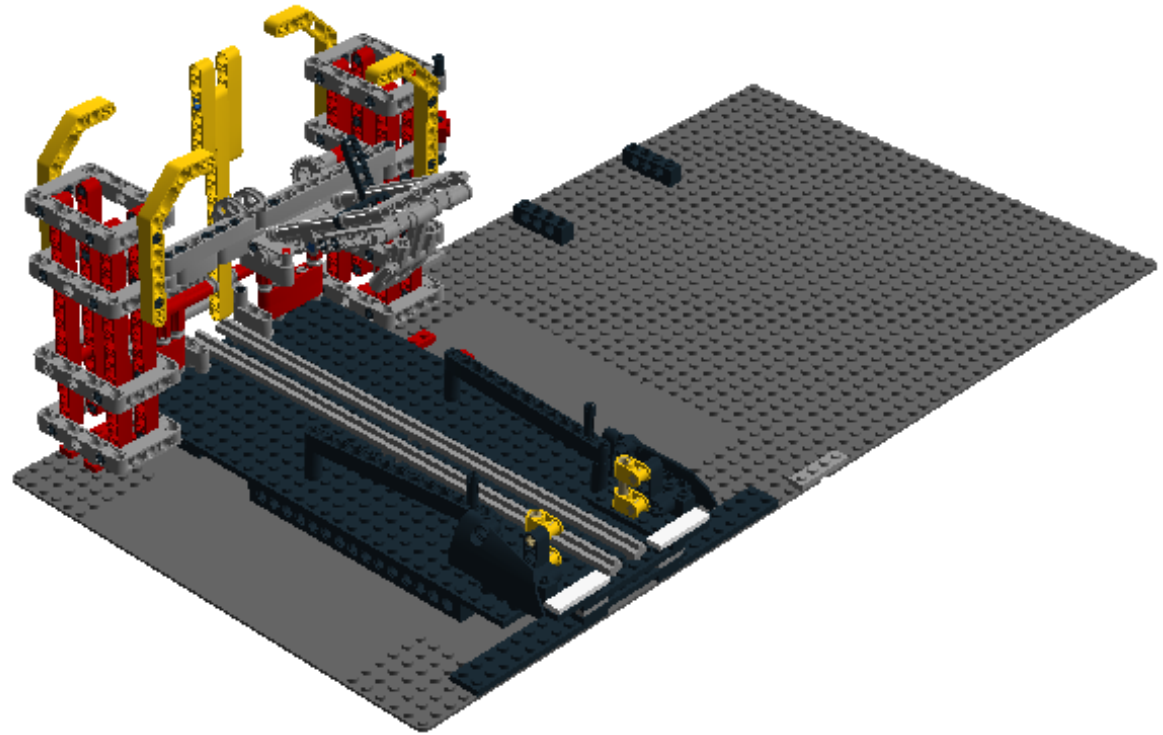

Step 185 of 278

2 x



1 x



1 x

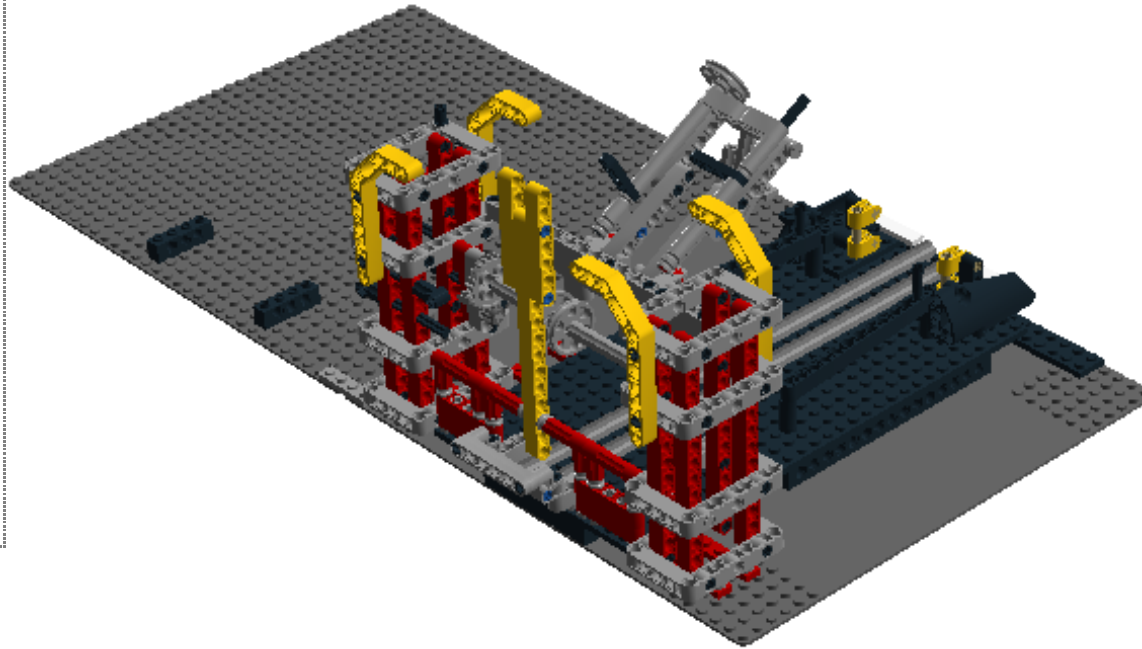

Step 186 of 278

1 x



1 x

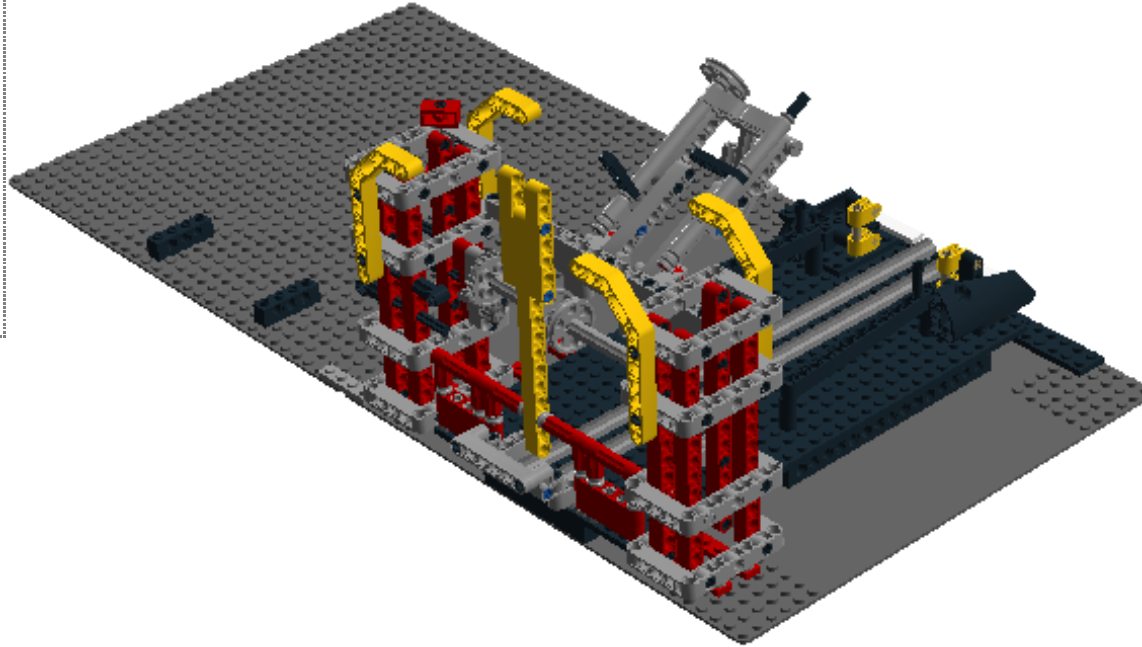

Step 187 of 278

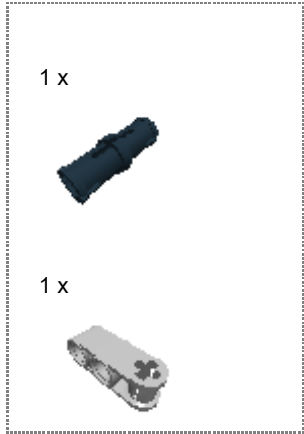

Step 188 of 278

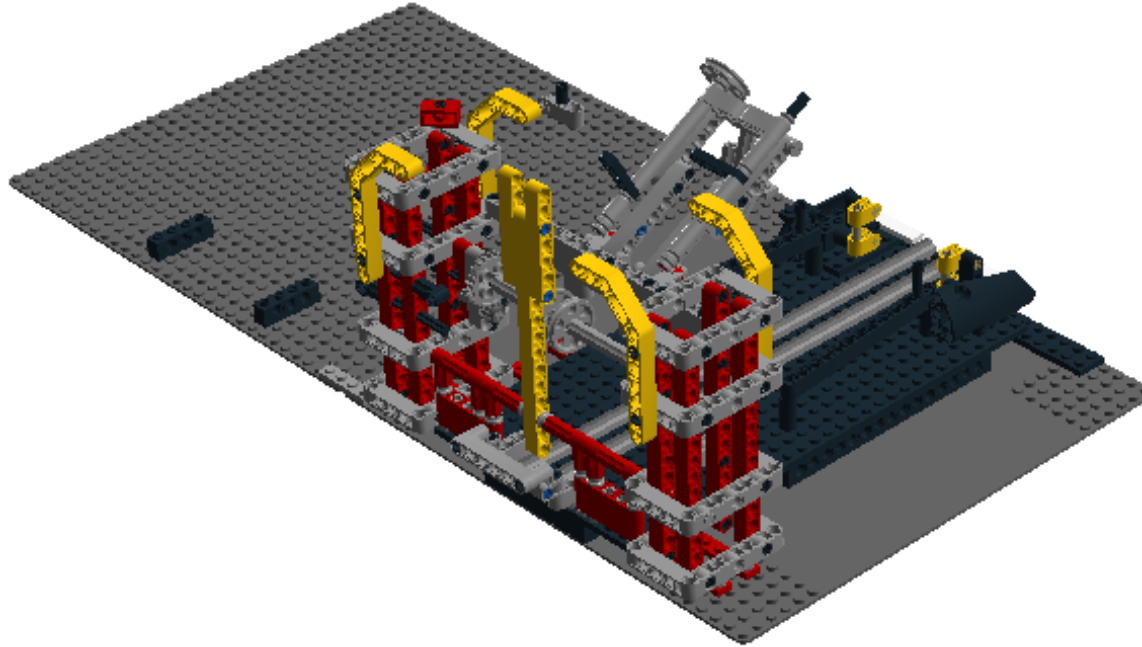

Step 189 of 278

1 x

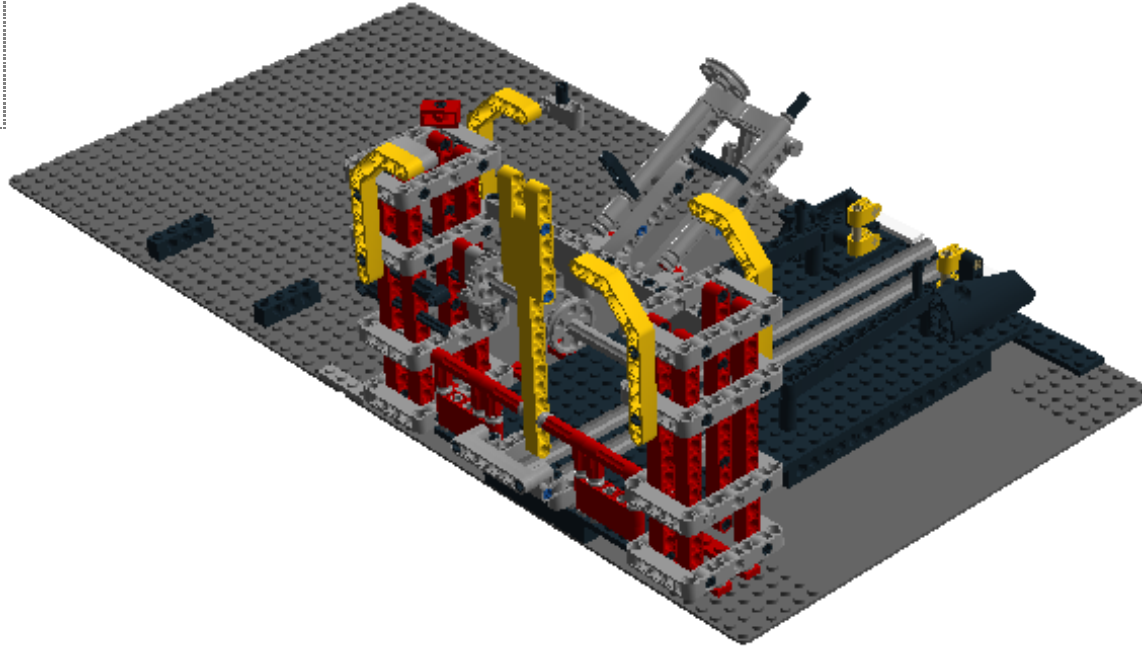
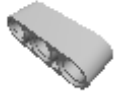

Step 190 of 278

3 x

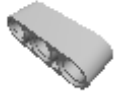

1 x

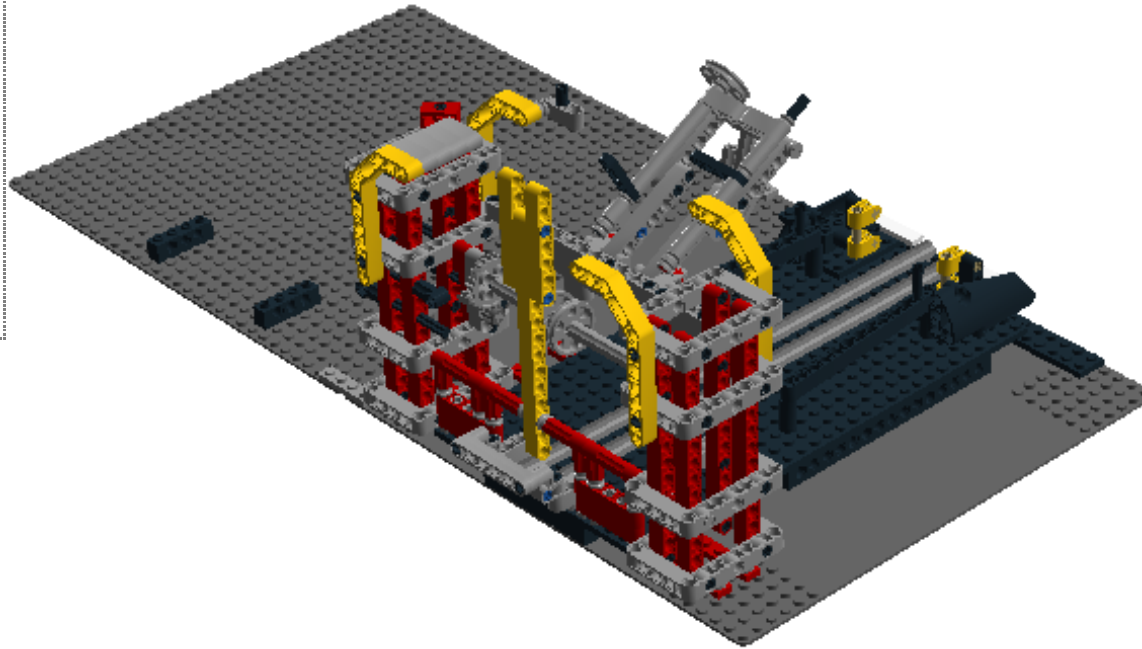

Step 191 of 278

1 x



1 x



2 x

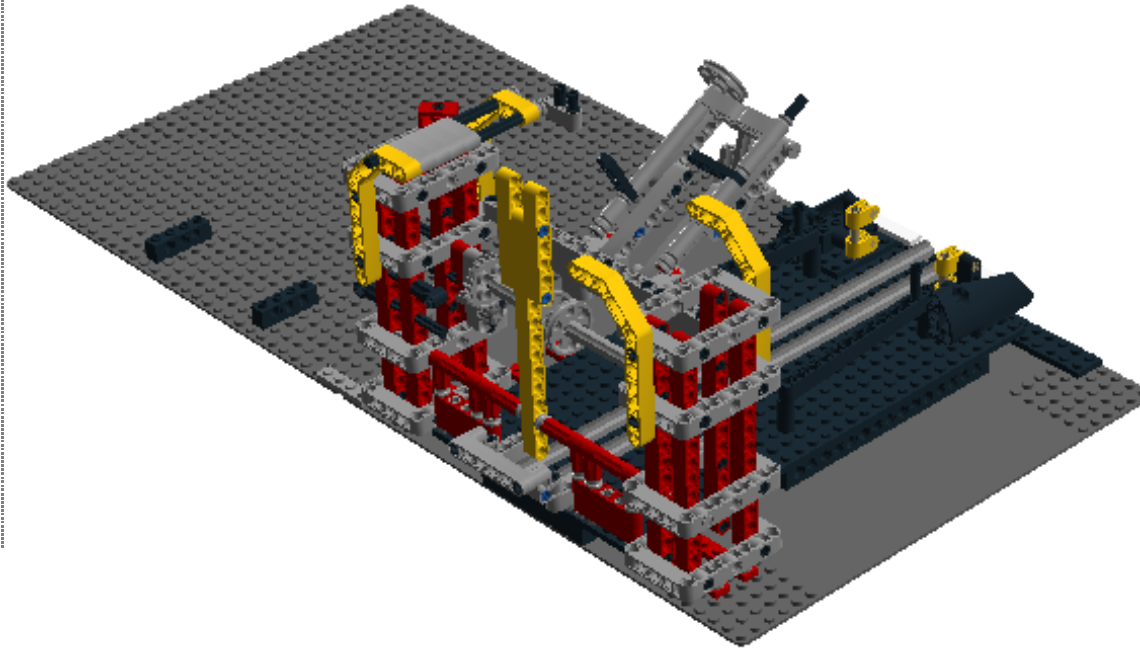

Step 192 of 278

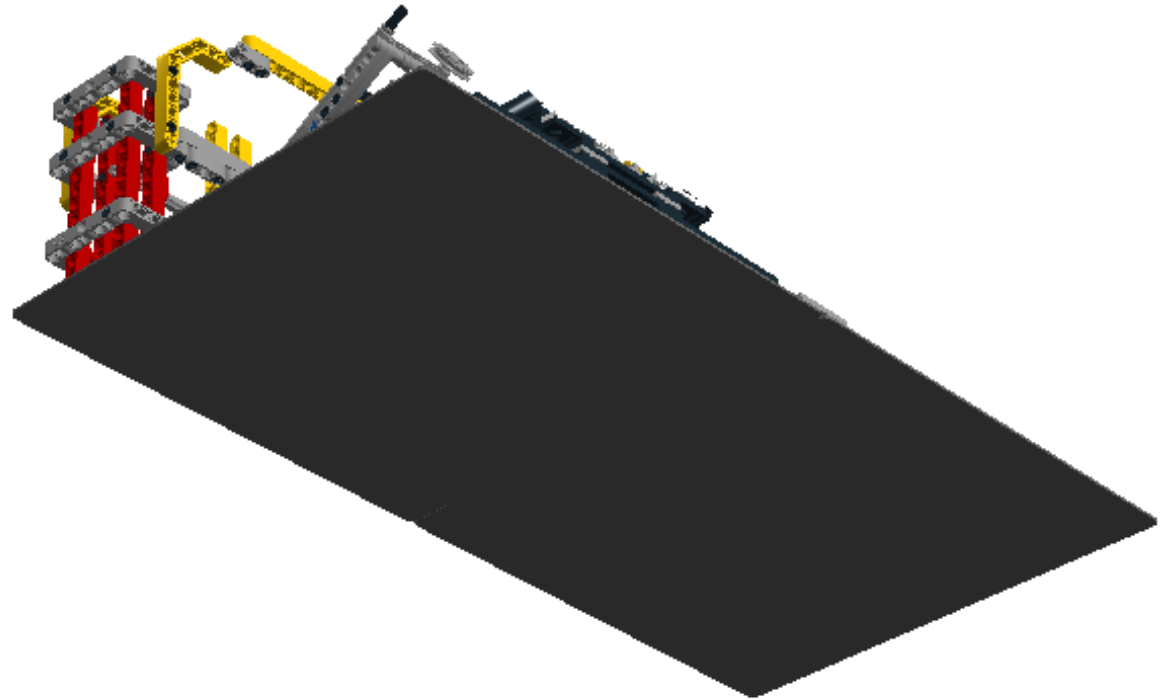
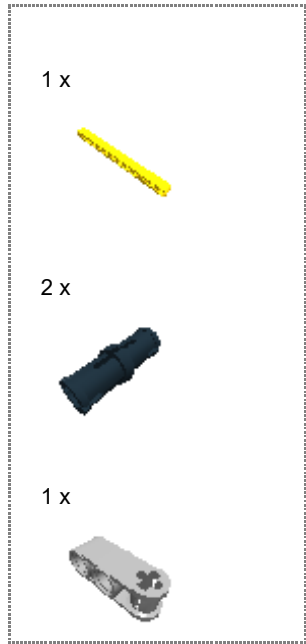

Step 193 of 278

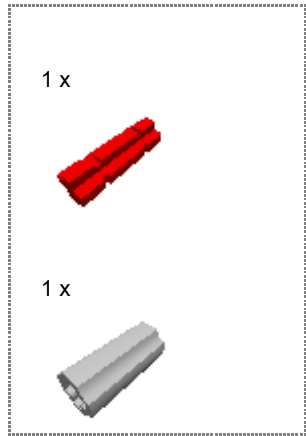

Step 194 of 278

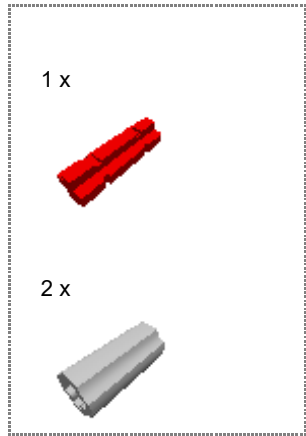

Step 195 of 278

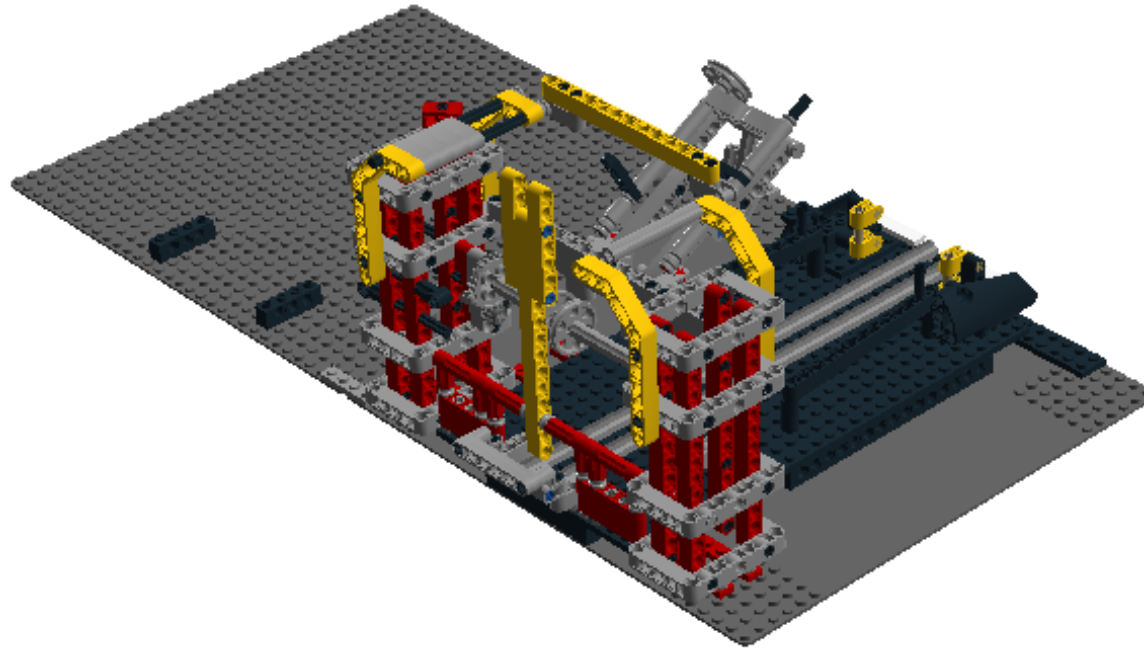

Step 196 of 278

1 x



1 x



1 x

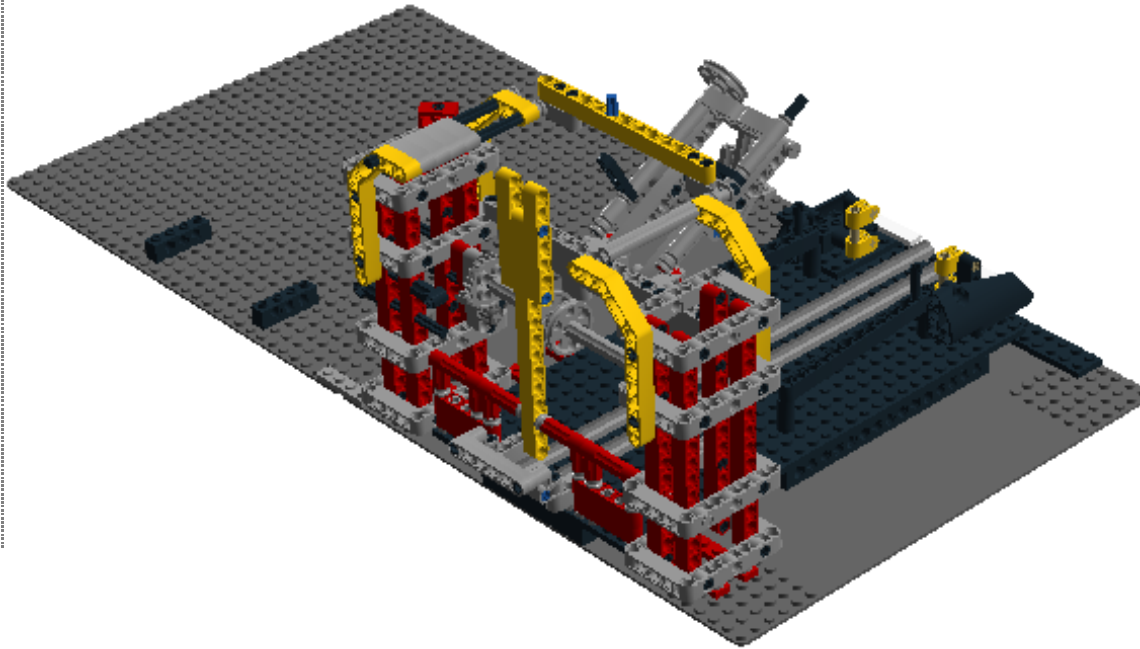

Step 197 of 278

1 x



1 x

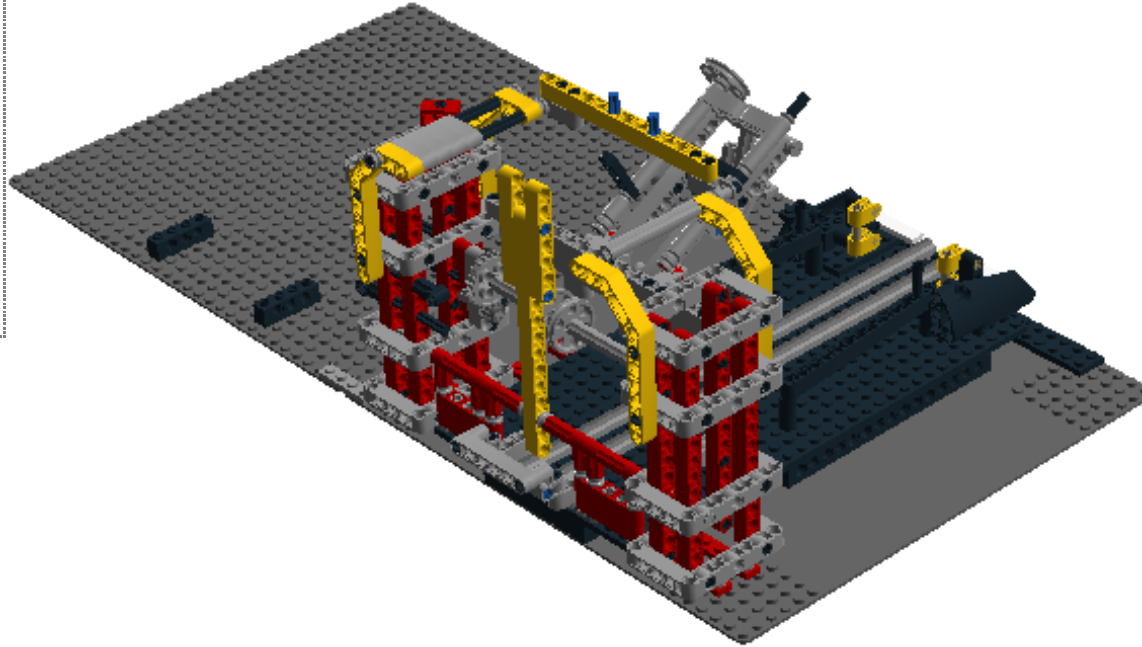

Step 198 of 278

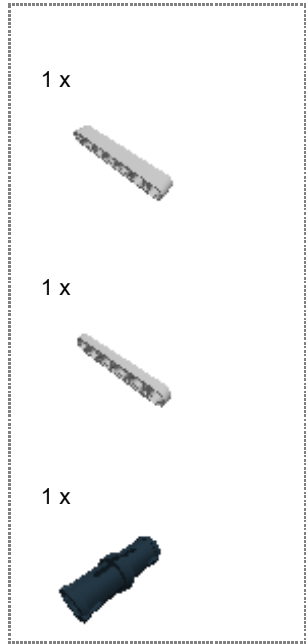

Step 199 of 278

2 x



1 x



1 x



Step 200 of 278

1 x



Step 201 of 278

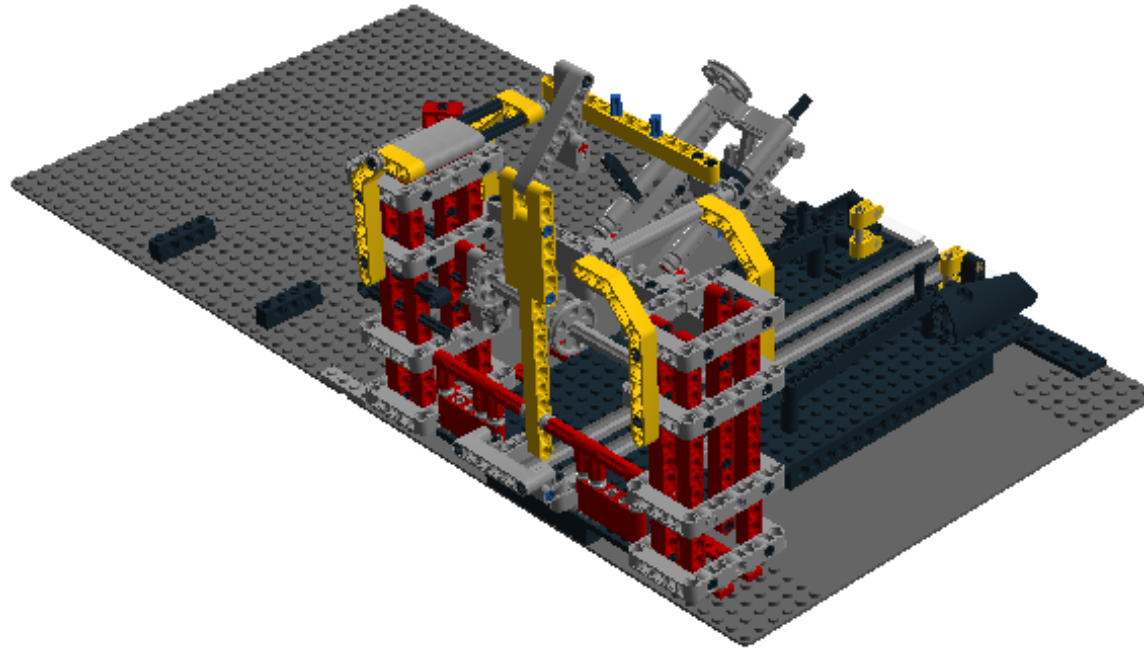

Step 202 of 278

1 x

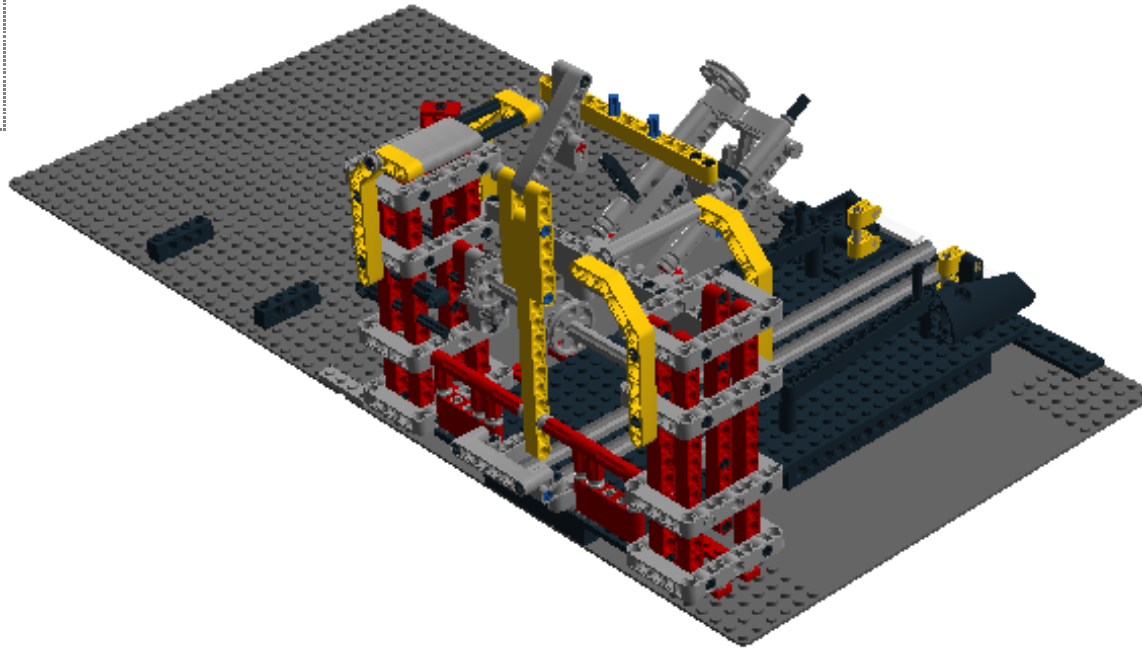

Step 203 of 278

1 x

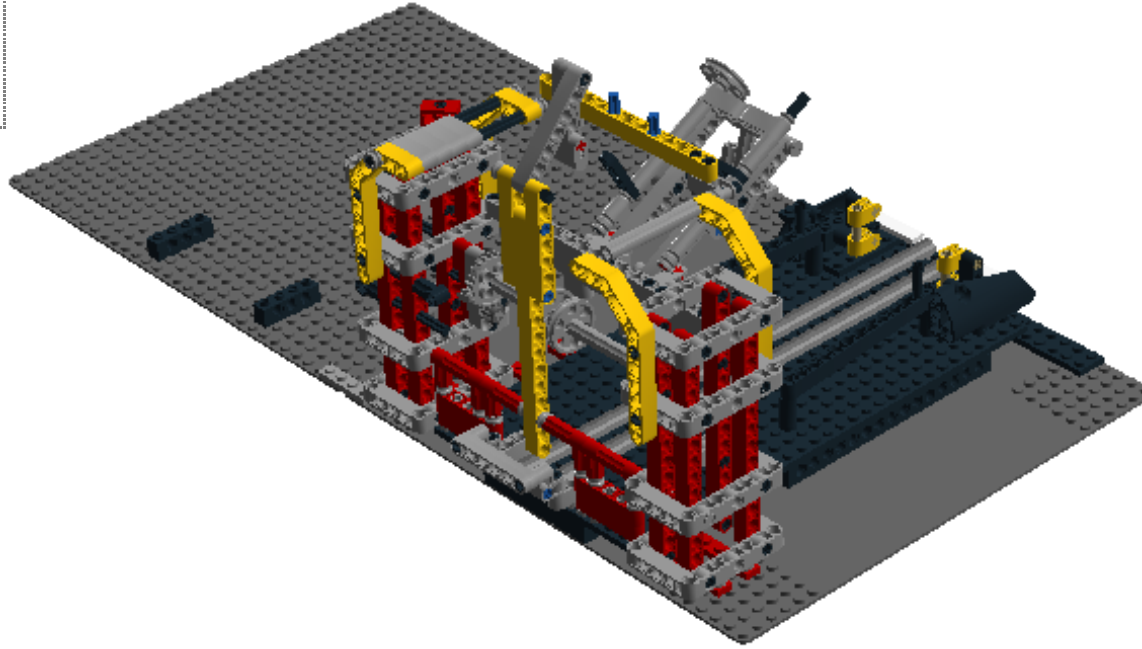

Step 204 of 278

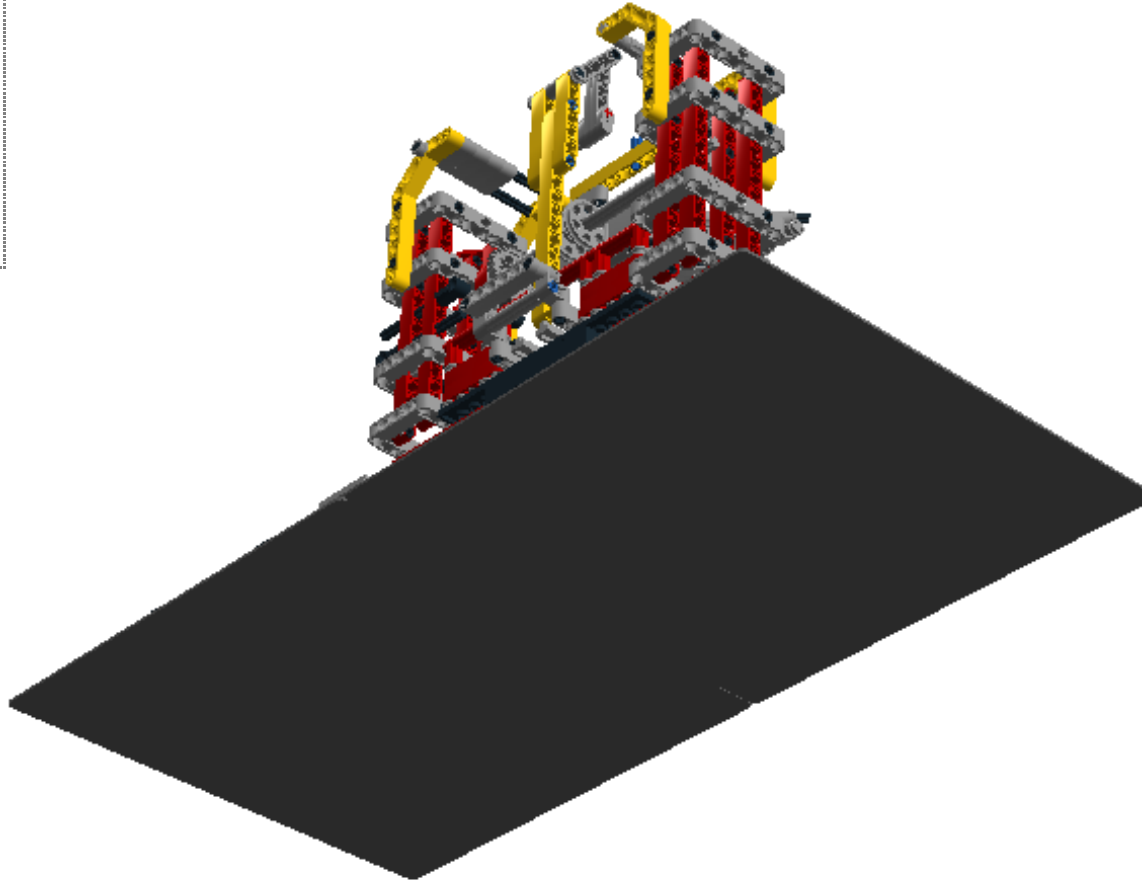
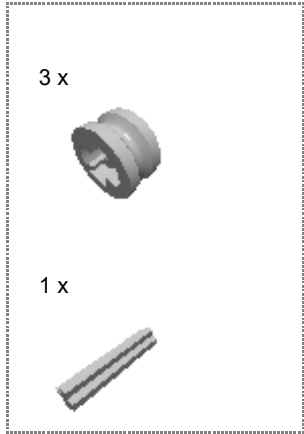

Step 205 of 278

1 x



1 x



1 x

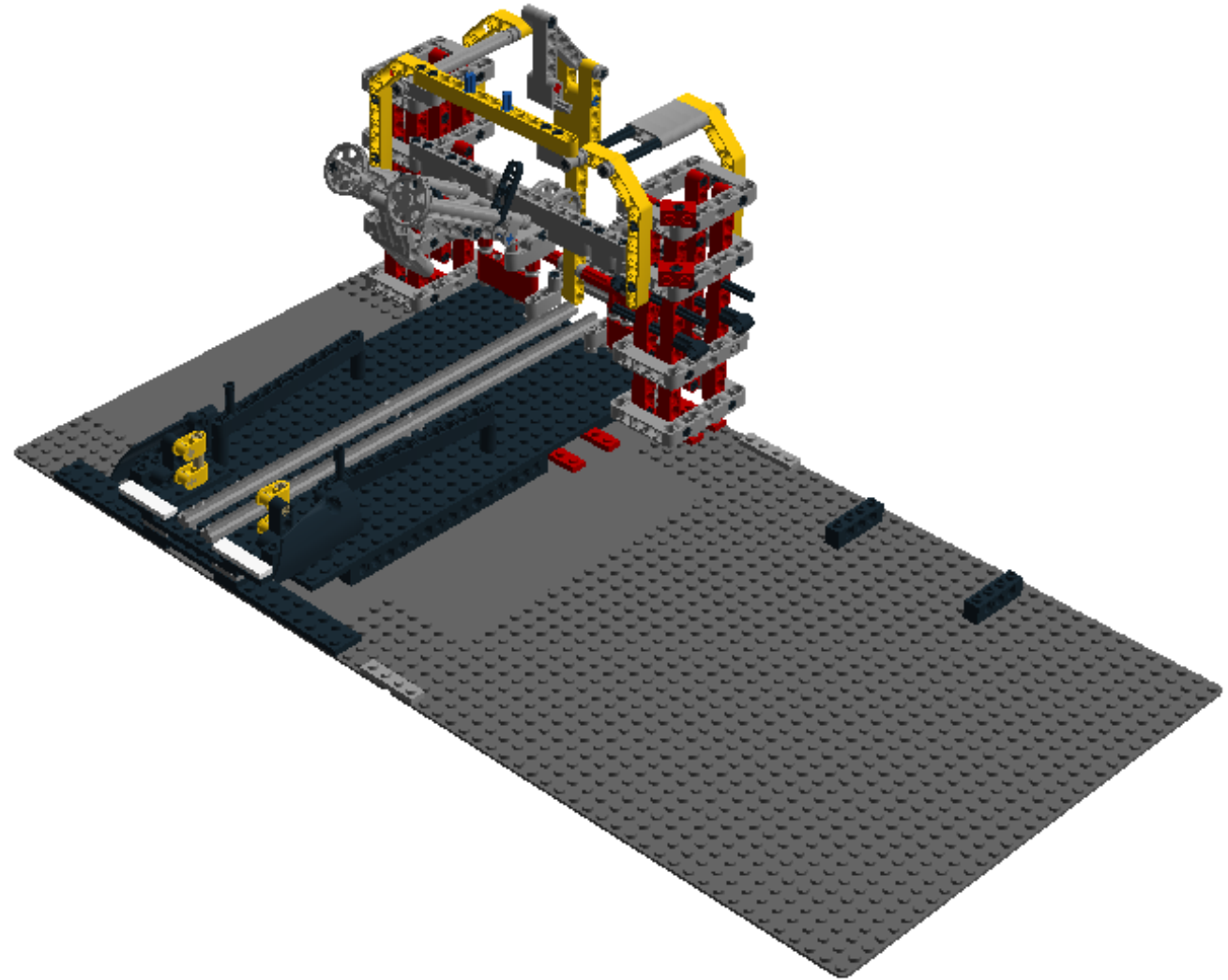

Step 206 of 278

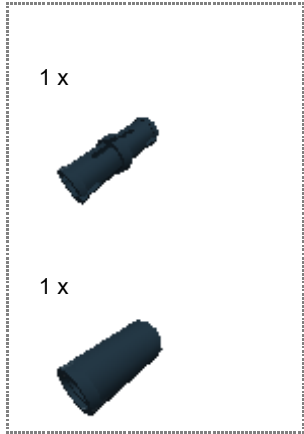

Step 207 of 278

1 x

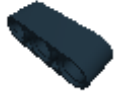

1 x



1 x

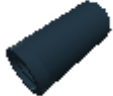

Step 208 of 278

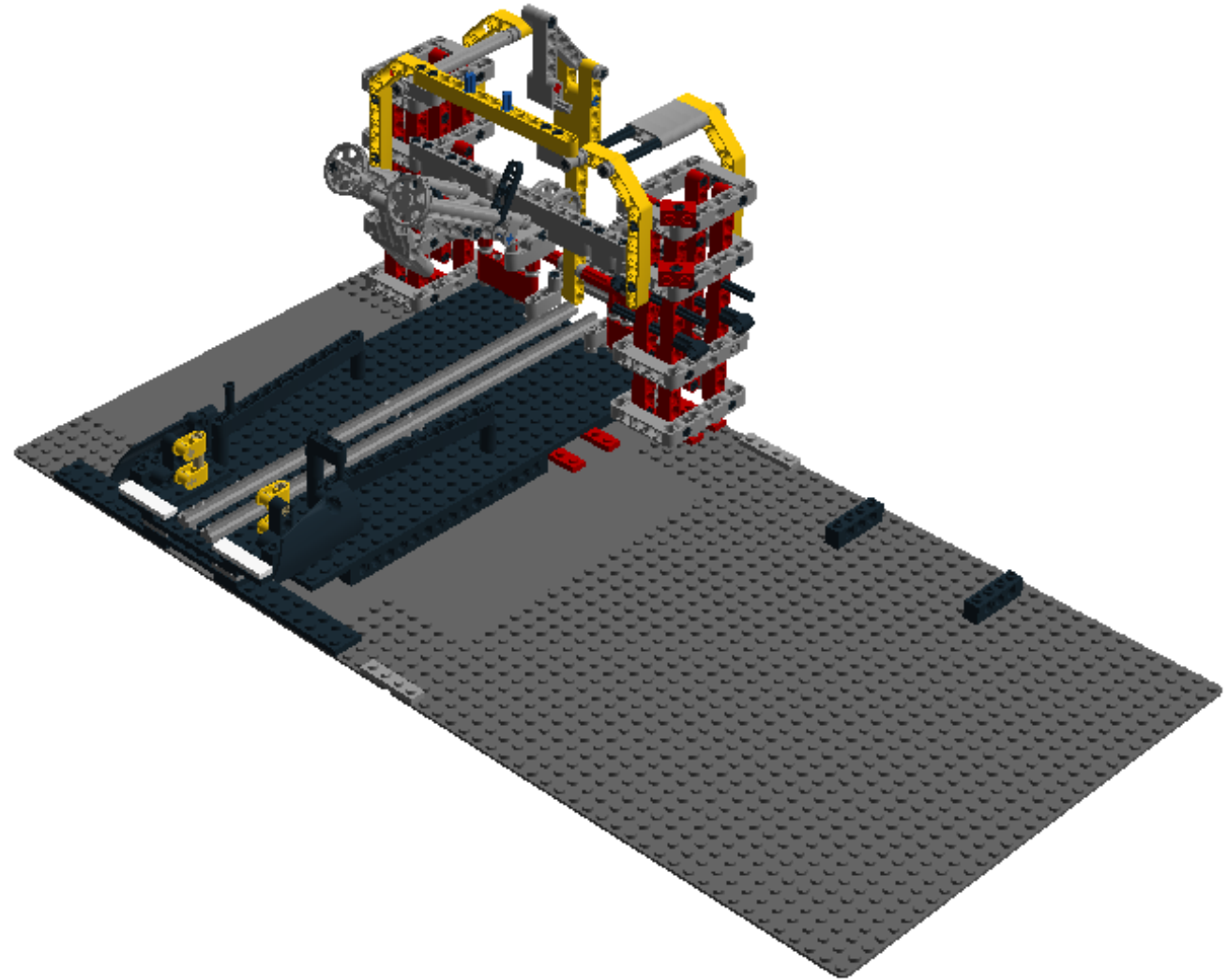

Step 209 of 278

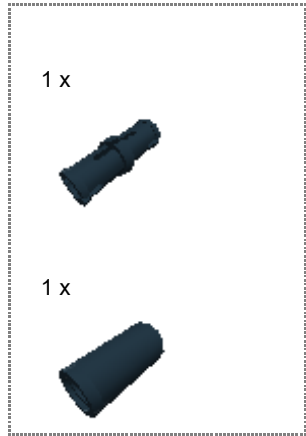

Step 210 of 278

1 x

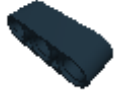

1 x



1 x

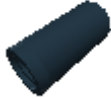

Step 211 of 278

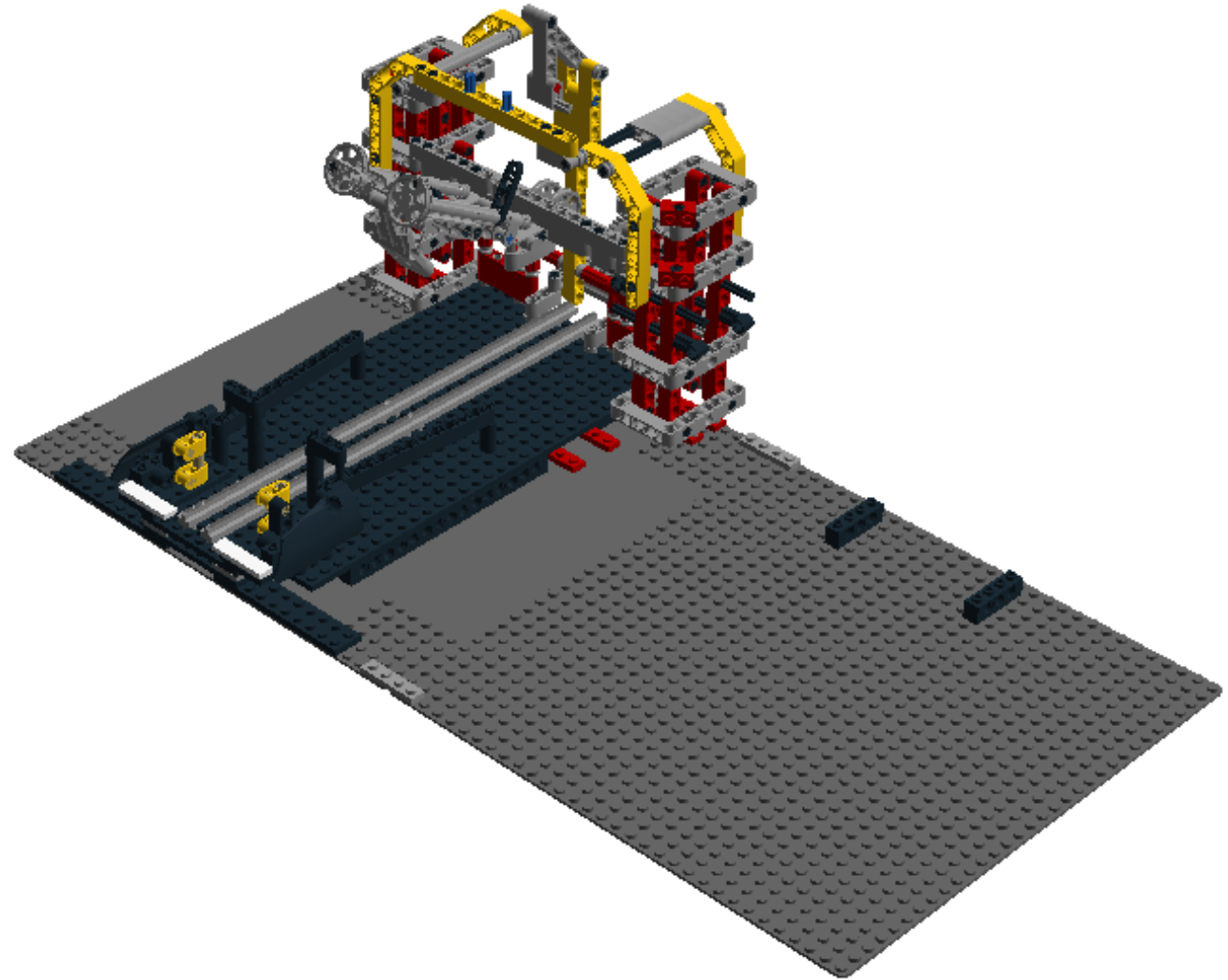

Step 212 of 278

1 x



1 x



1 x



Step 213 of 278

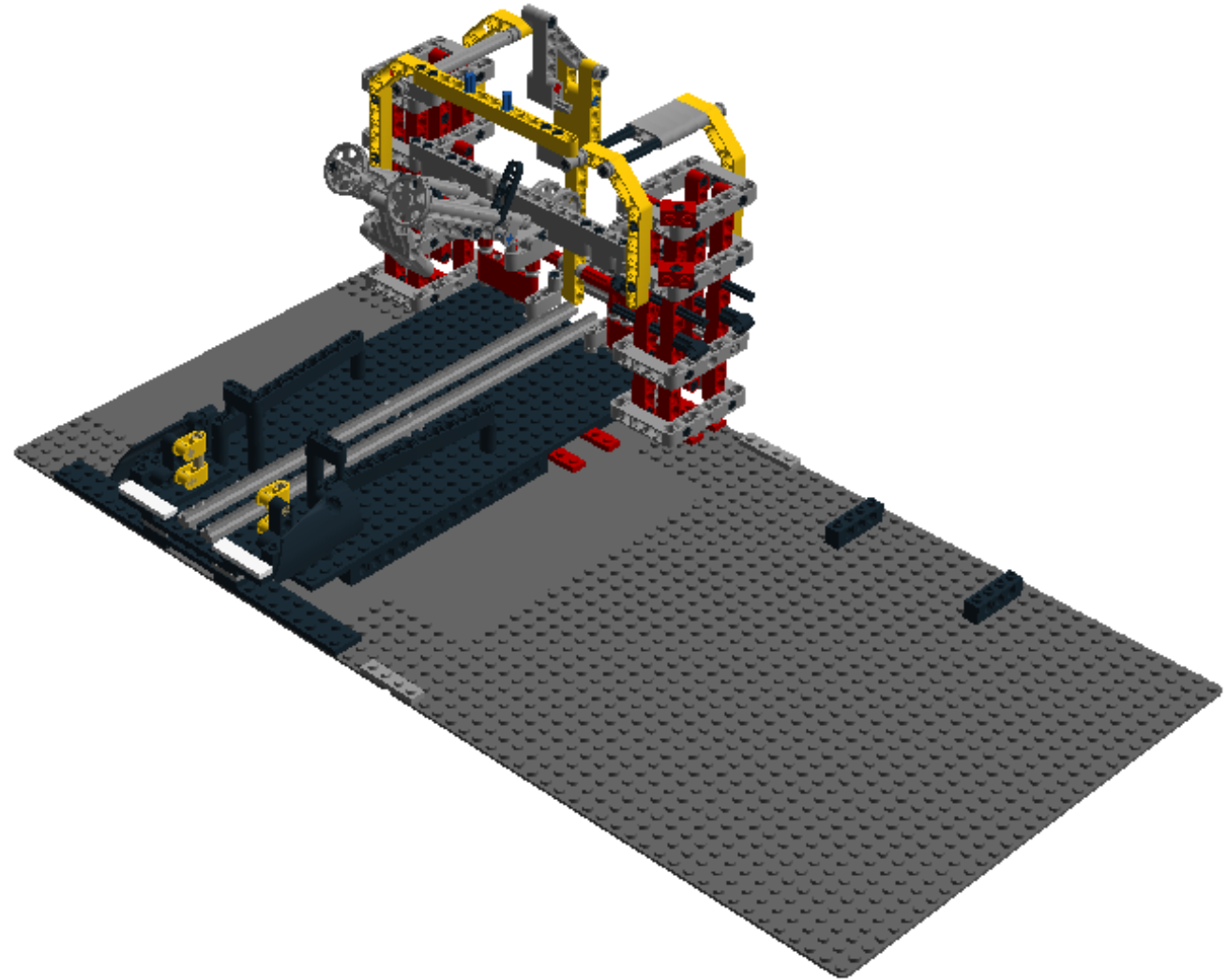

Step 214 of 278

1 x



1 x



1 x



Step 215 of 278

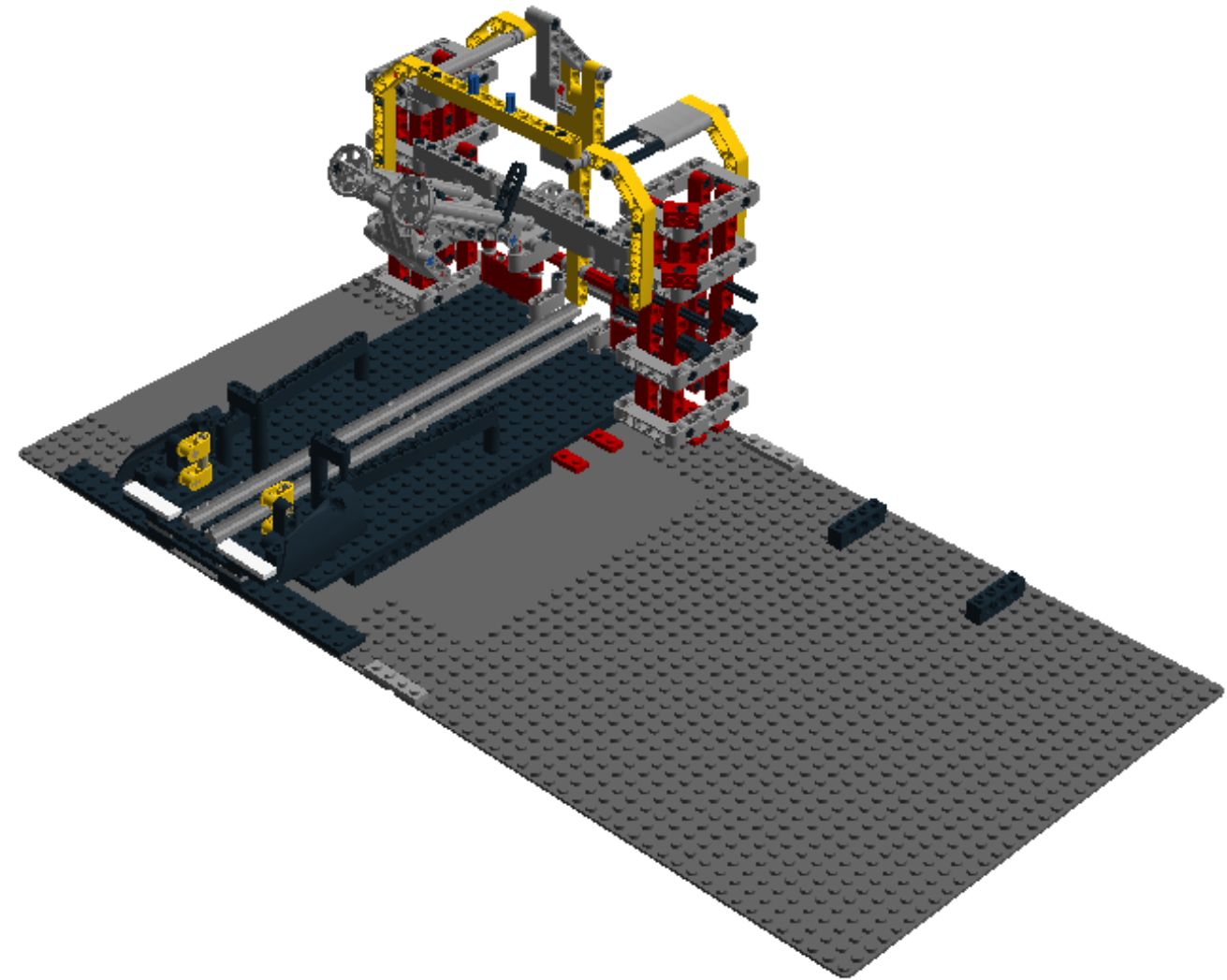

Step 216 of 278

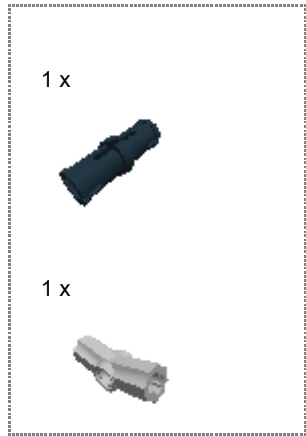

Step 217 of 278

1 x



1 x



1 x



Step 218 of 278

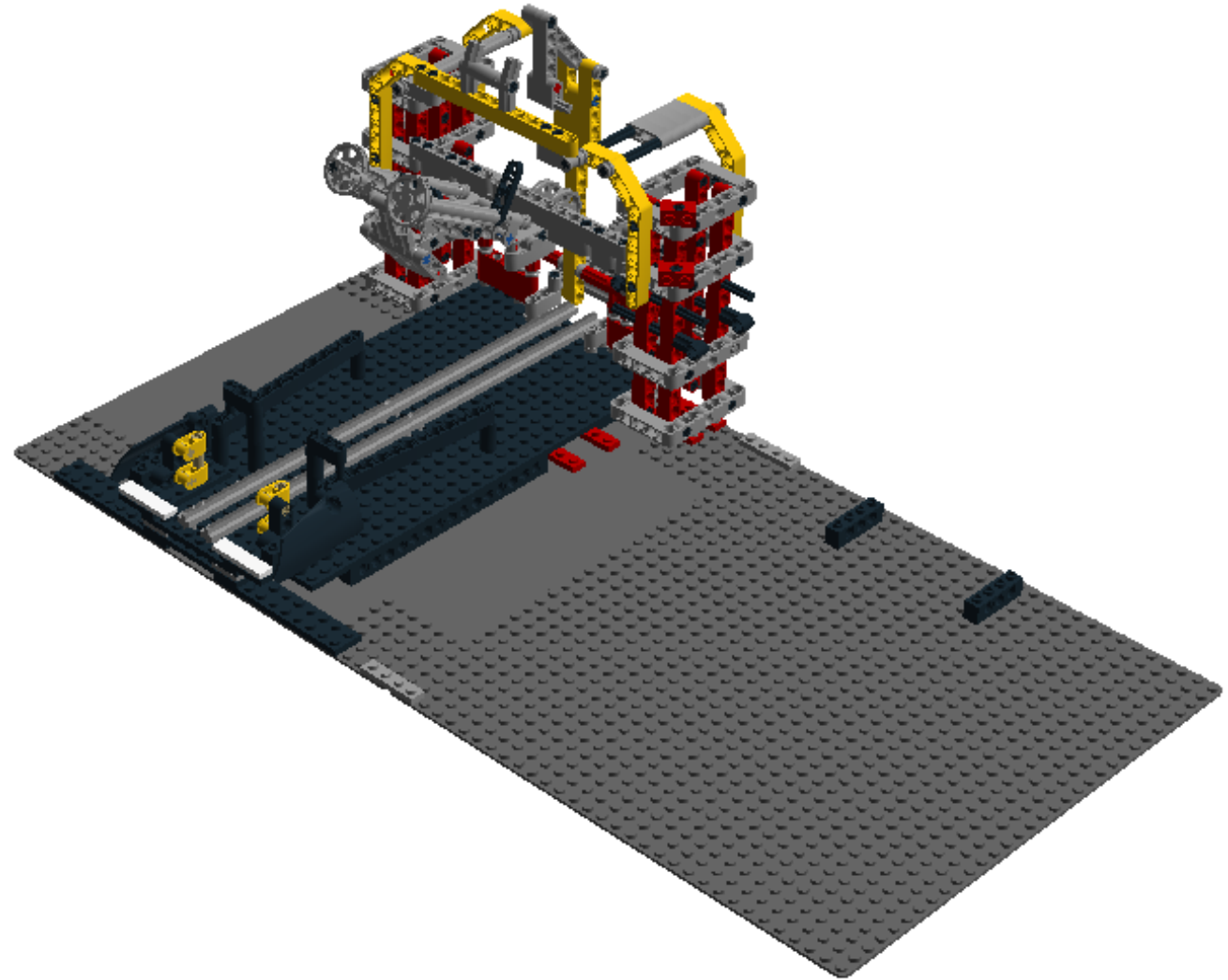

Step 219 of 278

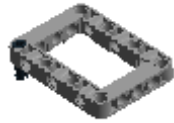
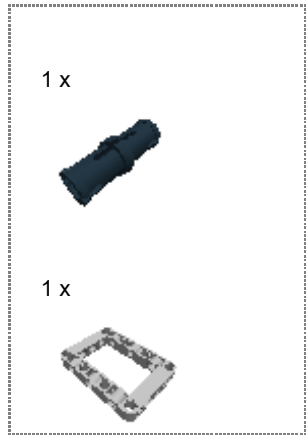

Step 220 of 278

1 x



1 x



1 x

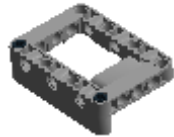

Step 221 of 278

1 x



1 x

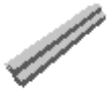

2 x



Step 222 of 278

1 x



1 x

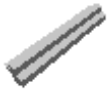

1 x



1 x

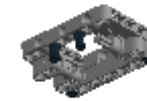

Step 223 of 278

1 x



2 x



1 x



Step 224 of 278

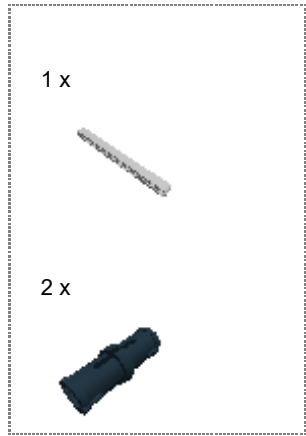

Step 225 of 278

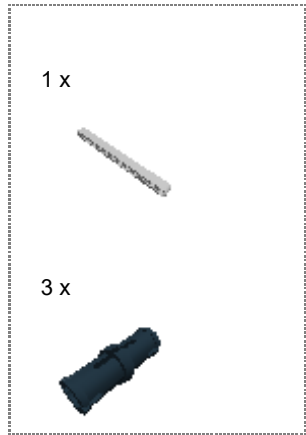

Step 226 of 278

1 x



2 x



1 x

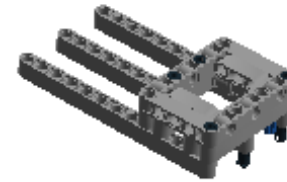

Step 227 of 278

1 x



1 x



1 x

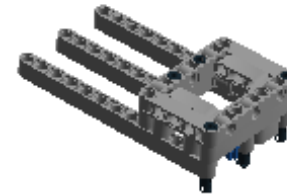
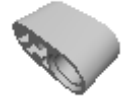

Step 228 of 278

1 x



2 x



1 x

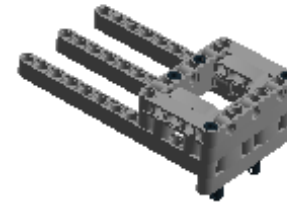
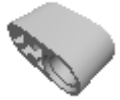

Step 229 of 278

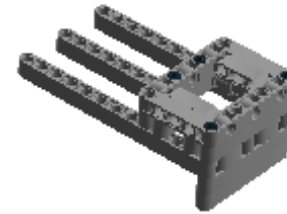
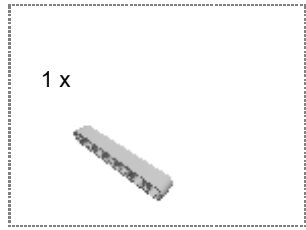

Step 230 of 278

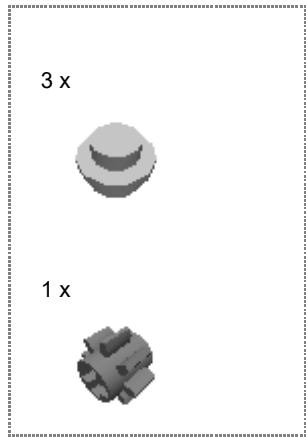

Step 231 of 278

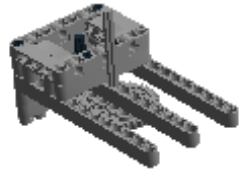
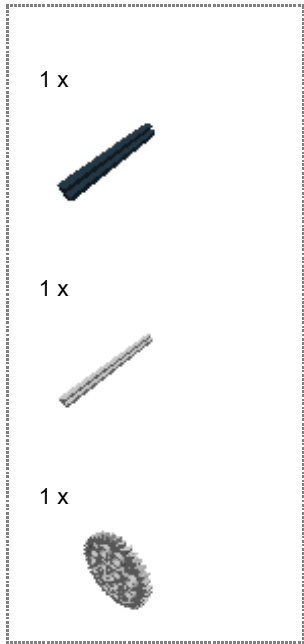

Step 232 of 278

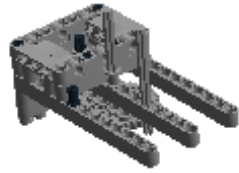
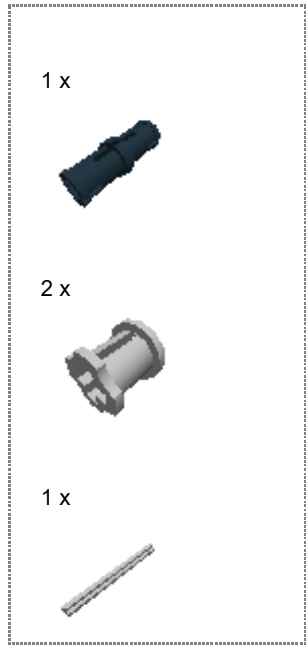

Step 233 of 278

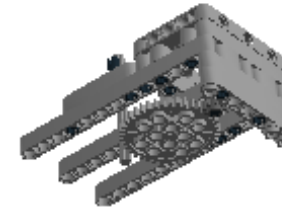
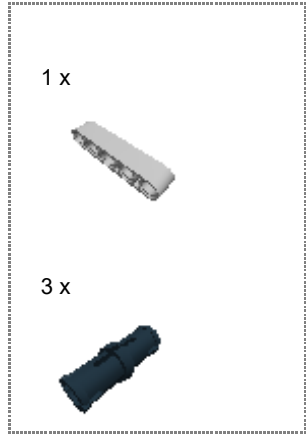

Step 234 of 278

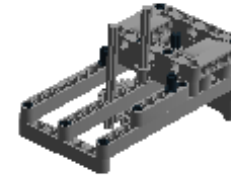
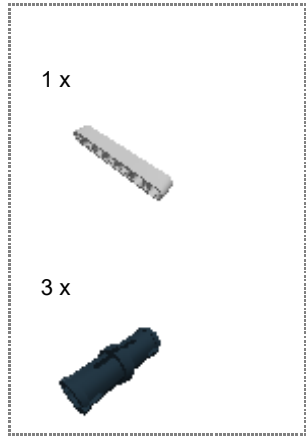

Step 235 of 278

1 x



1 x



2 x

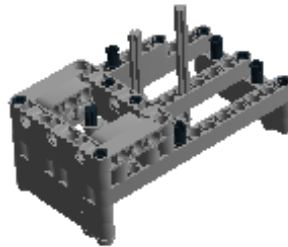

Step 236 of 278

1 x



1 x



1 x



1 x

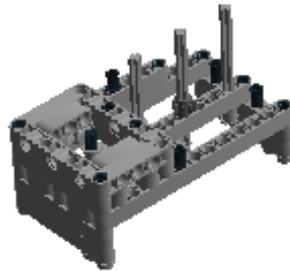

Step 237 of 278

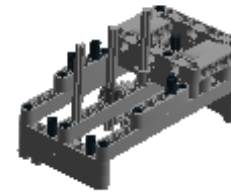
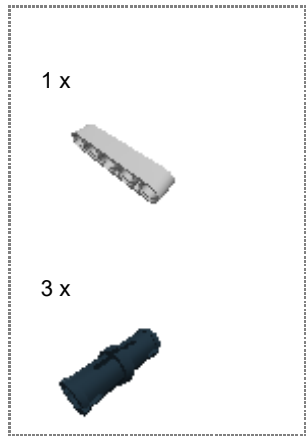

Step 238 of 278

1 x



1 x



1 x



1 x

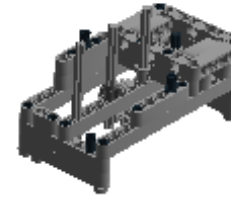
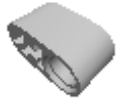

Step 239 of 278

1 x



1 x



1 x

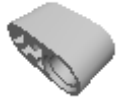

1 x

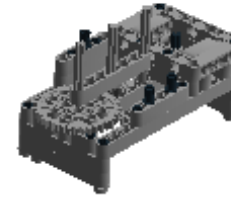

Step 240 of 278

1 x



1 x



1 x



1 x

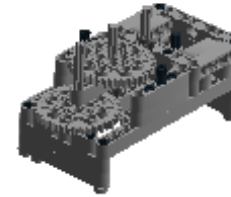

Step 241 of 278

2 x



1 x



1 x

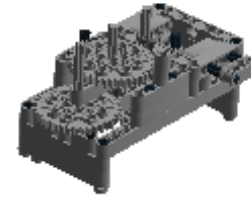

Step 242 of 278

2 x



1 x



1 x

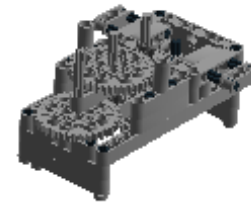

Step 243 of 278

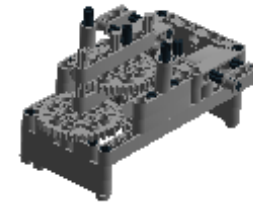
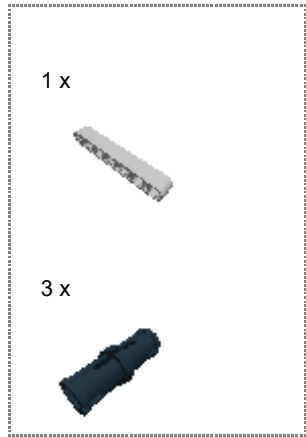

Step 244 of 278

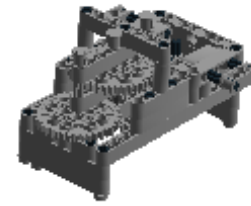
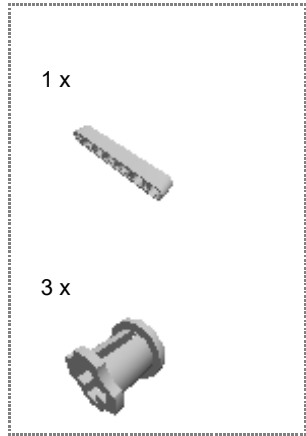

Step 245 of 278

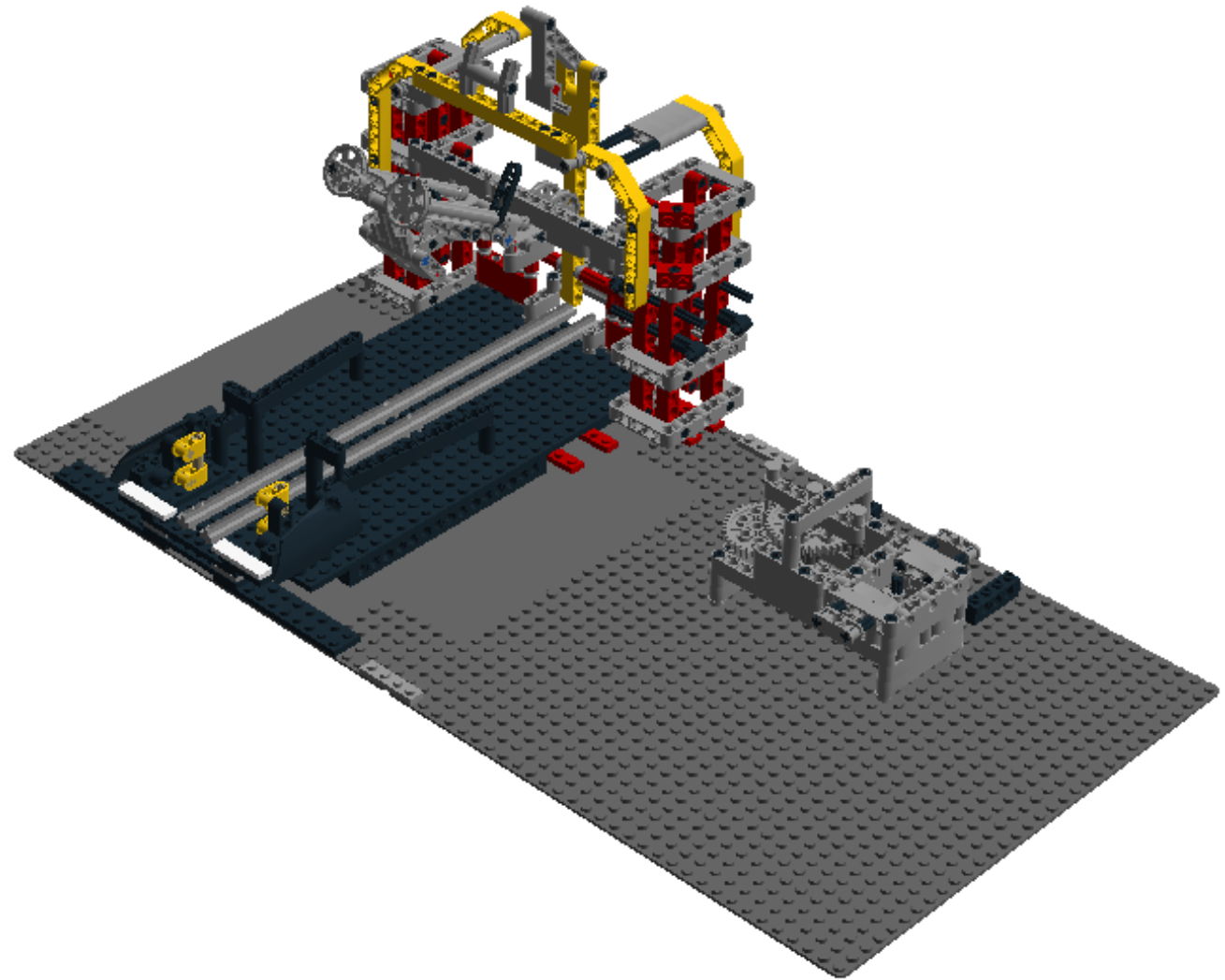

Step 246 of 278

3 x



1 x



Step 247 of 278

1 x



2 x



1 x



Step 248 of 278

1 x



1 x



2 x

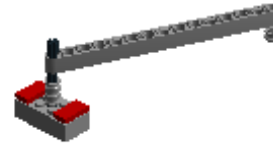

Step 249 of 278

1 x



2 x



1 x

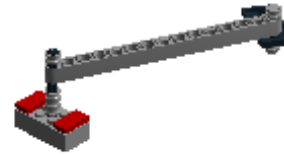

Step 250 of 278

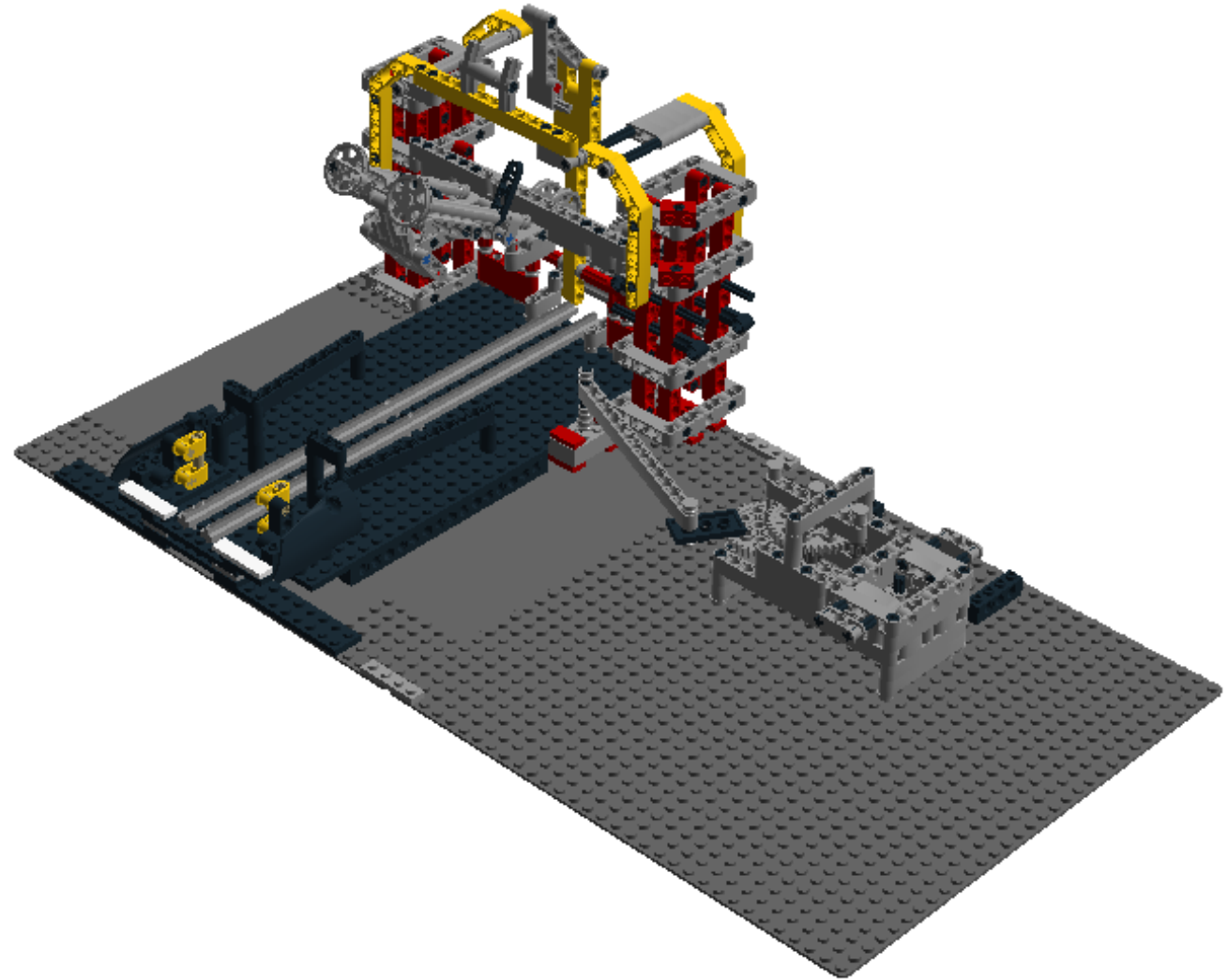

Step 251 of 278

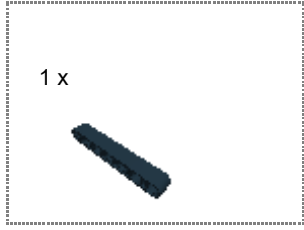

Step 252 of 278

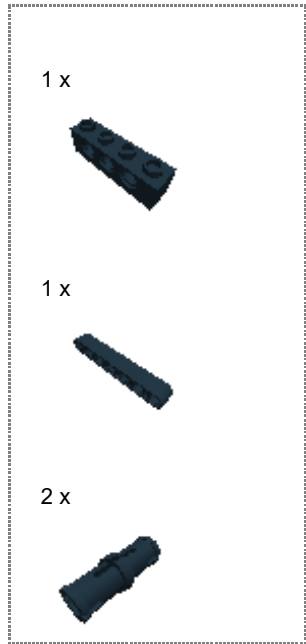

Step 253 of 278



Step 254 of 278

1 x



1 x



2 x



Step 255 of 278

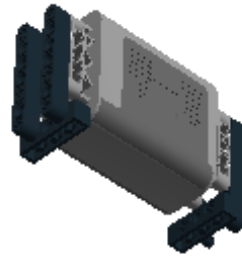
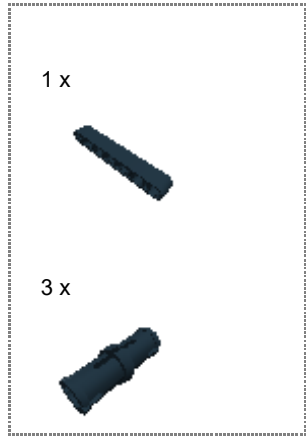

Step 256 of 278

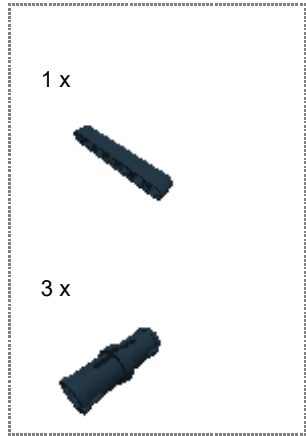

Step 257 of 278

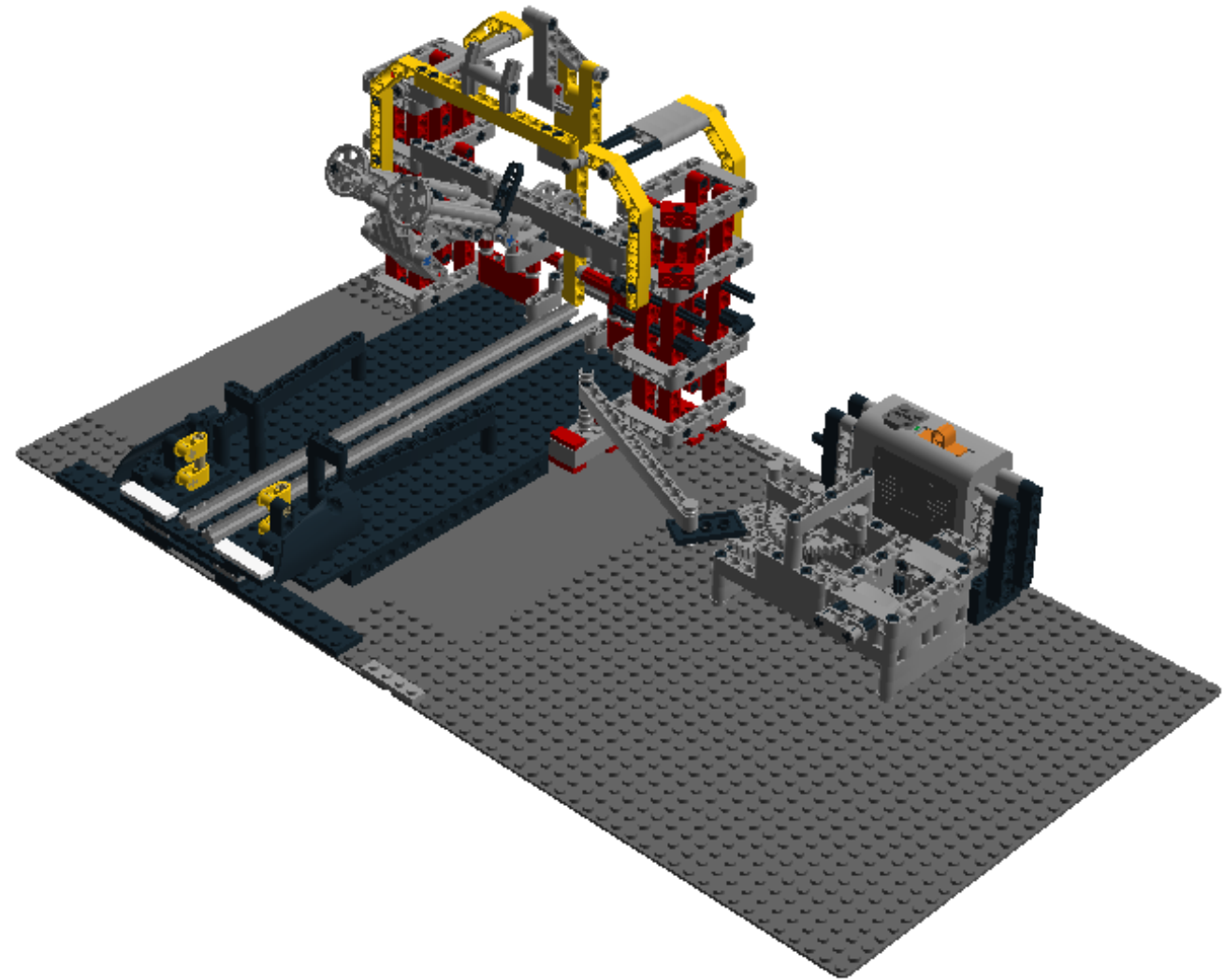

Step 258 of 278

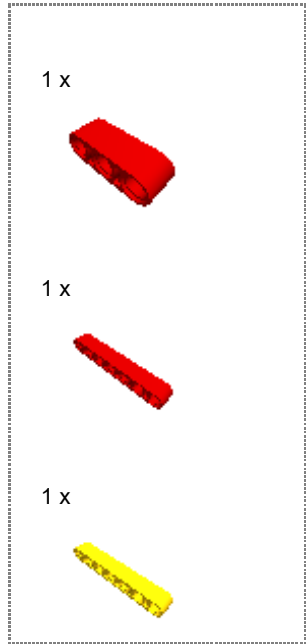

Step 259 of 278

1 x

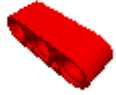

1 x



1 x



1 x

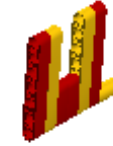

Step 260 of 278

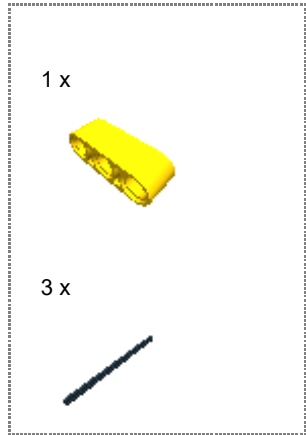

Step 261 of 278

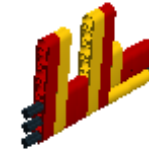
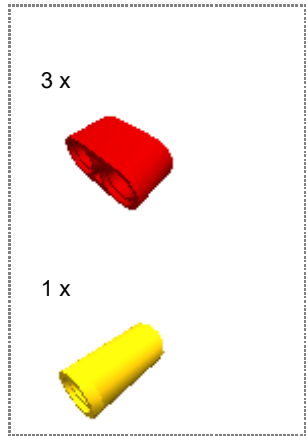

Step 262 of 278

1 x

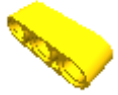

1 x



2 x



Step 263 of 278

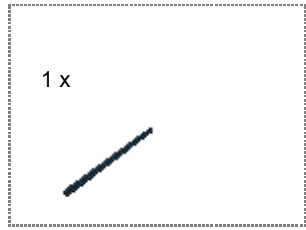

Step 264 of 278

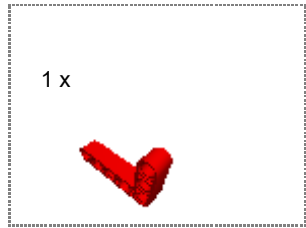

Step 265 of 278

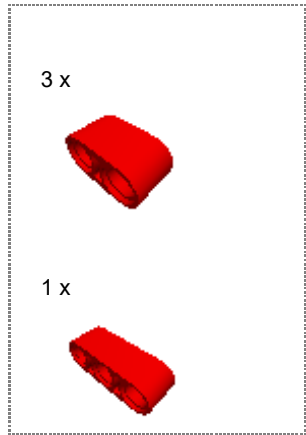

Step 266 of 278

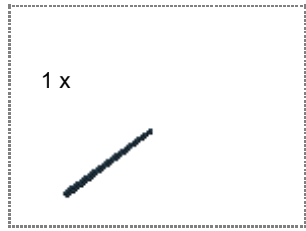

Step 267 of 278

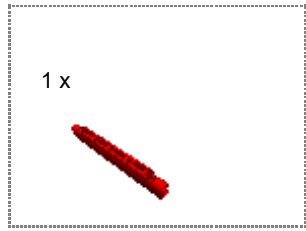

Step 268 of 278

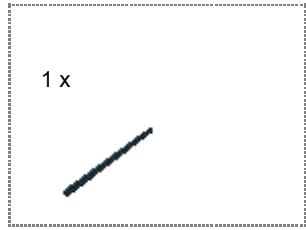

Step 269 of 278

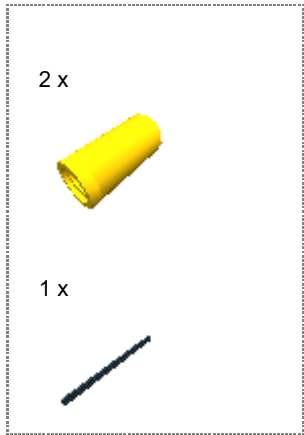

Step 270 of 278

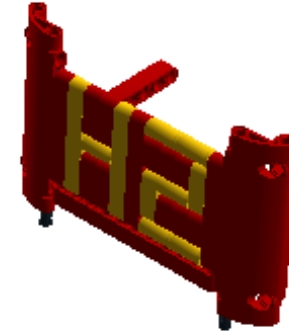
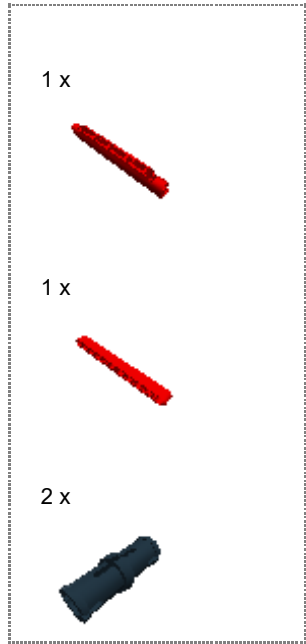

Step 271 of 278

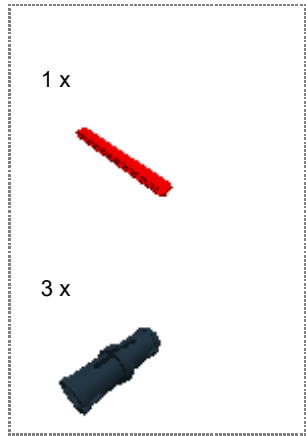

Step 272 of 278

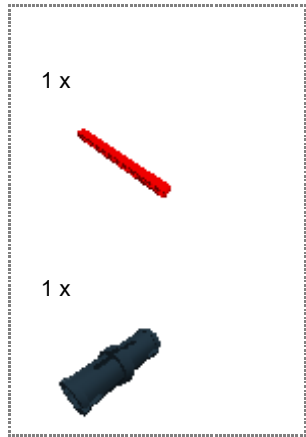

Step 273 of 278

2 x



1 x



1 x



Step 274 of 278

1 x



2 x



1 x



Step 275 of 278

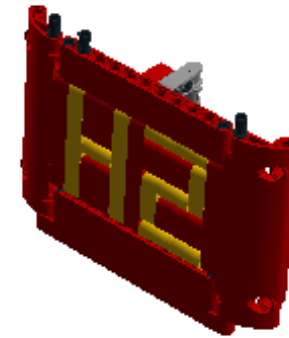
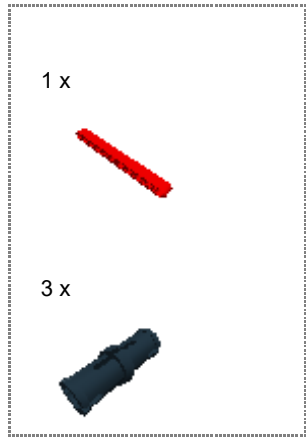

Step 276 of 278

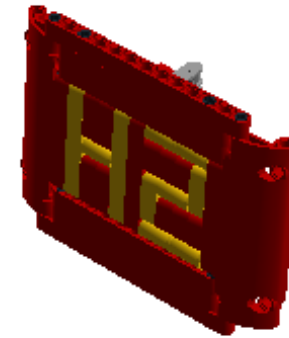
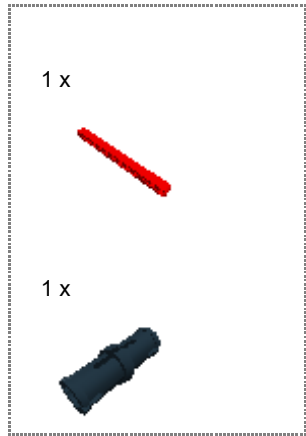



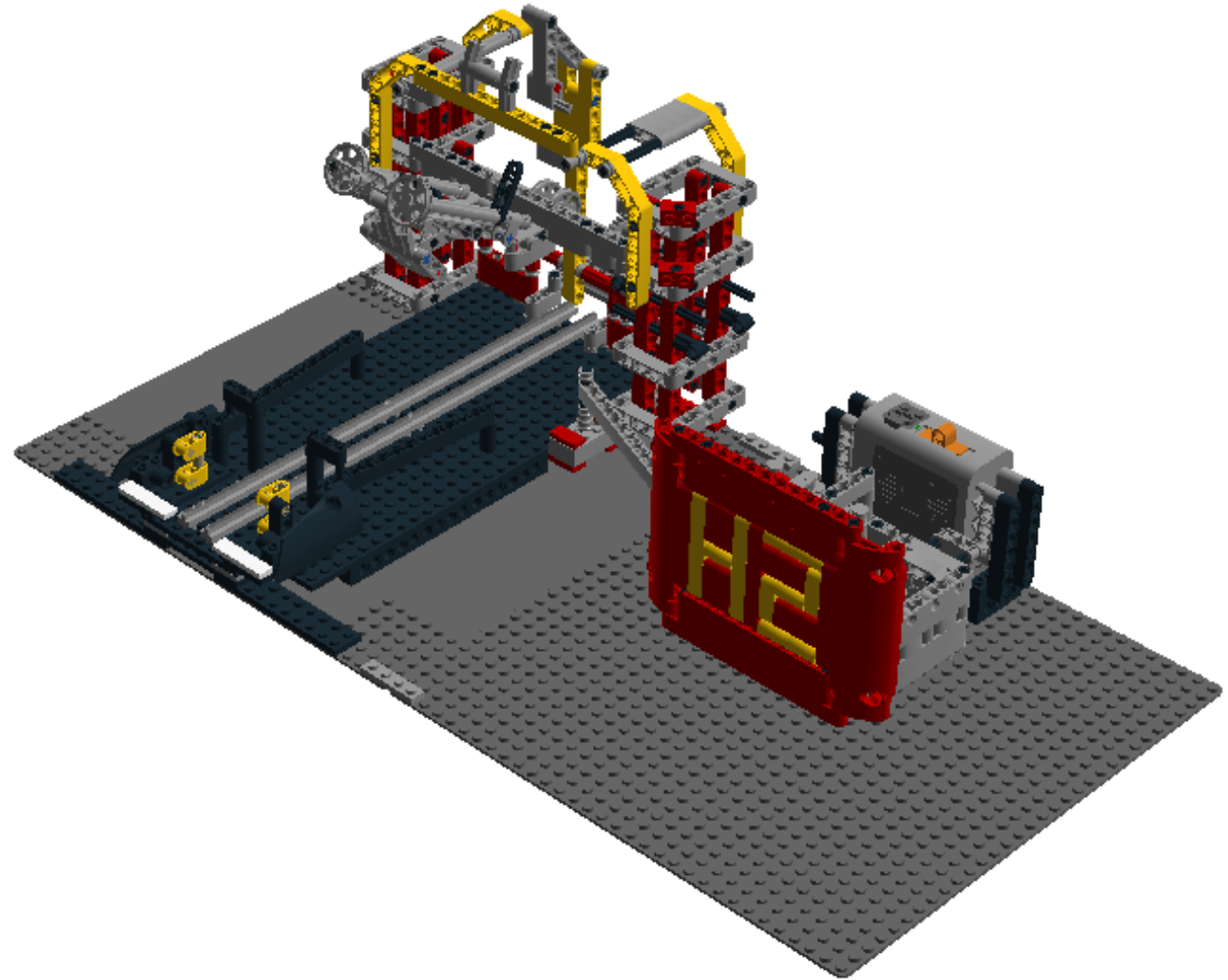



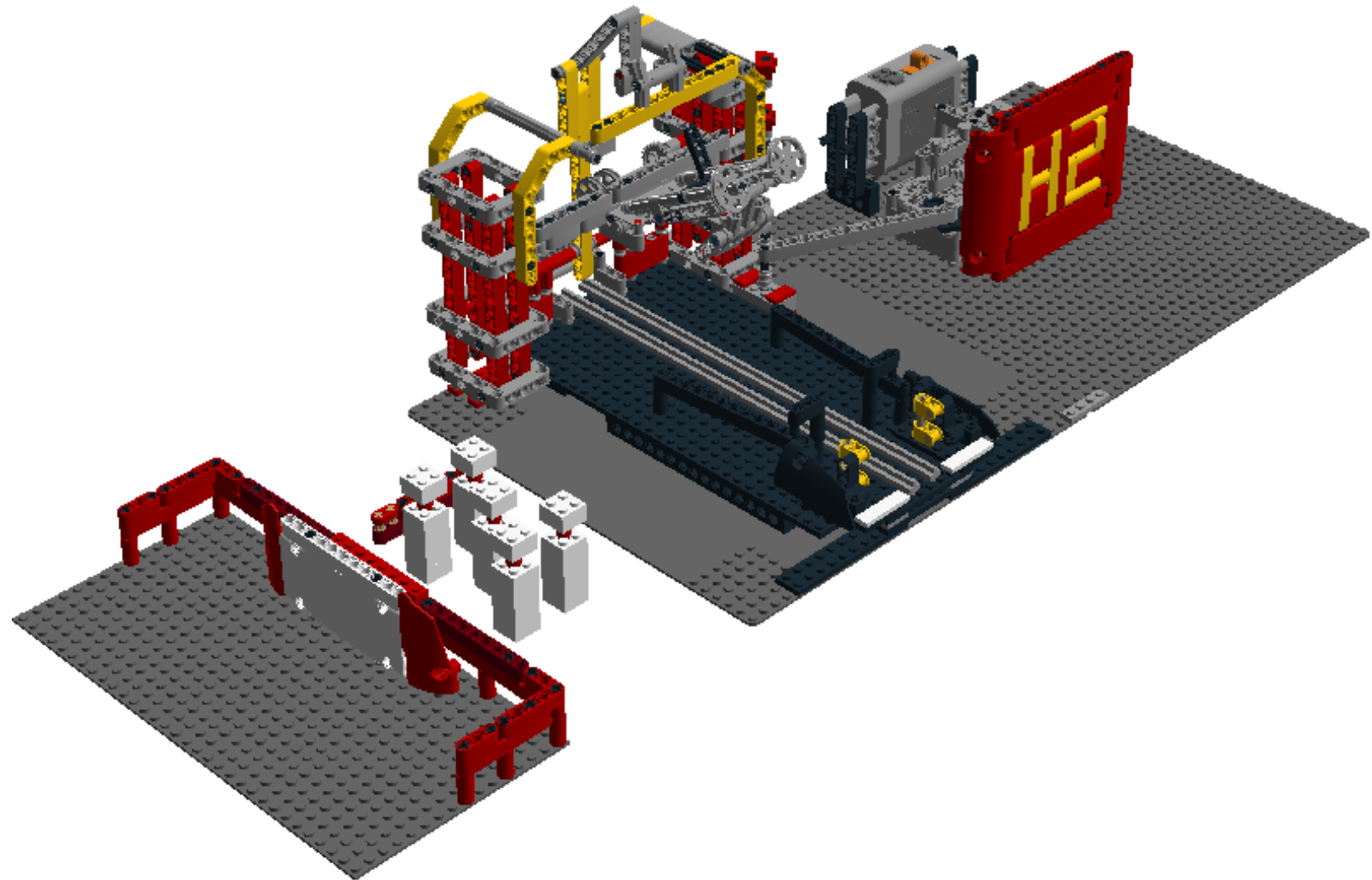

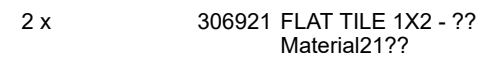
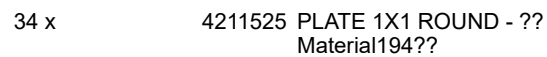
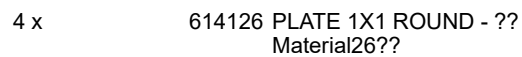
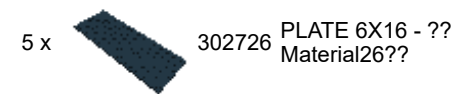
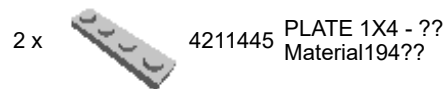
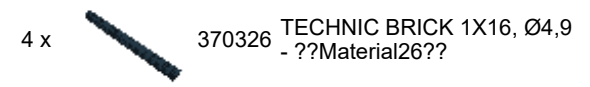
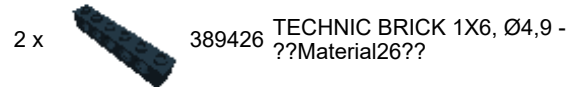
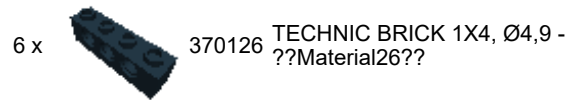
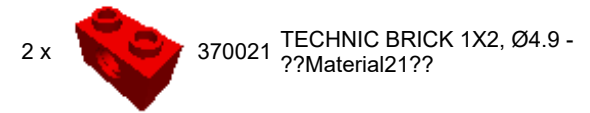
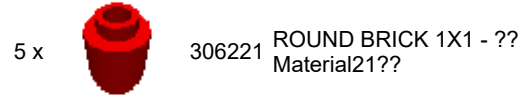
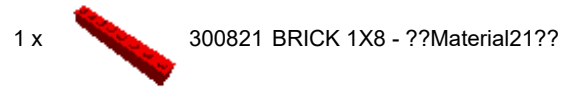
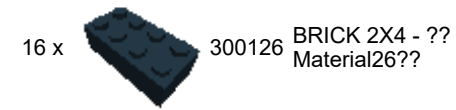
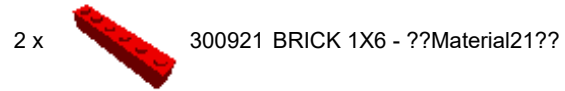
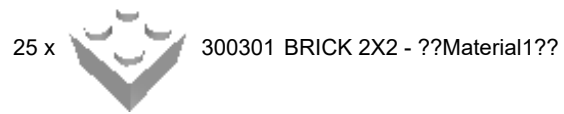









Step 277 of 278



Step 278 of 278





								
2 x		243101 FLAT TILE 1X4 - ?? Material1??	2 x		4211413 FLAT TILE 2X2 - ?? Material194??	1 x		370926 PLATE 2X4, 3XØ4.9 - ?? Material26??
3 x		4211444 PLATE 2X4, 3XØ4.9 - ?? Material194??	2 x		373826 PLATE 2X8 W. HOLES - ?? Material26??	4 x		4211742 STRAIGHT RAIL - ?? Material194??
1 x		4541325 RIGHT PANEL 3X7 - ?? Material26??	1 x		4540798 RIGHT PANEL 3X7 - ?? Material21??	1 x		4541924 LEFT PANEL 3X7 - ?? Material26??
1 x		4540801 LEFT PANEL 3X7 - ?? Material21??	2 x		4525727 Shell 3x11x2 Ø 4.85 08 - ?? Material21??	1 x		Batterybox 4X11X7 - ?? Material28??,?? Material106??,?? Material194??,?? Material199??
1 x		4211862 TECHNIC 2M BEAM - ?? Material194??	8 x		4185664 TECHNIC 2M BEAM - ?? Material21??	2 x		4142822 TECHNIC 3M BEAM - ?? Material26??
8 x		4211655 TECHNIC 3M BEAM - ?? Material194??	5 x		4153718 TECHNIC 3M BEAM - ?? Material21??	2 x		4153707 TECHNIC 3M BEAM - ?? Material24??

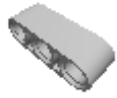

5 x

4211651

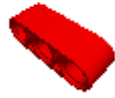
TECHNIC 5M BEAM - ??
Material194??

5 x

4128589

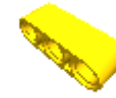
TECHNIC 5M BEAM - ??
Material21??

4 x

3252426

TECHNIC 7M BEAM - ??
Material26??

13 x

4211665

TECHNIC 7M BEAM - ??
Material194??

5 x

4162098

TECHNIC 7M BEAM - ??
Material21??

4 x

4187082

TECHNIC 7M BEAM - ??
Material24??

2 x

4211610

TECHNIC ANG. BEAM 4X2
90 DEG - ??Material194??

3 x

4539283

TECHNIC 9M BEAM - ??
Material154??

2 x

4535771

T-BEAM 3X3 W/HOLE Ø4.8
- ??Material26??

2 x

4156151

TECHNIC 11M BEAM - ??
Material194??

1 x

3252501

TECHNIC 11M BEAM - ??
Material1??

4 x

4205035

TECHNIC 11M BEAM - ??
Material21??

2 x

4164422

TECHNIC 13M BEAM - ??
Material26??

3 x

4156299

TECHNIC 13M BEAM - ??
Material194??

4 x

4262082

TECHNIC 13M BEAM - ??
Material21??

1 x

4237328

TECHNIC 13M BEAM - ??
Material24??

1 x

4211770

TECHNIC 15M BEAM - ??
Material194??

8 x

3227821

TECHNIC 15M BEAM - ??
Material21??

											
1 x		3227824	TECHNIC 15M BEAM - ?? Material24??	3 x		4143154	TECHNIC ANG. BEAM 3X5 90 DEG. - ??Material21??	4 x		4107079	DOUBLE ANGULAR BEAM 3X7 45° - ??Material24??
2 x		4211741	TECHNIC LEVER 2M - ?? Material194??	2 x		4186678	TECHNIC LEVER 2M - ?? Material21??	2 x		4211566	TECHNIC LEVER 3M - ?? Material194??
2 x		4142236	LEVER 1X4, WITHOUT NOTCH - ??Material26??	8 x		4211586	TECHNIC 6M HALF BEAM - ??Material194??	42 x		4211573	1/2 BUSH - ?? Material194??
13 x		4142865	2M CROSS AXLE W. GROOVE - ??Material21??	165 x		278026	CONNECTOR PEG W. FRICTION - ?? Material26??	4 x		4211807	CONNECTOR PEG - ?? Material194??
18 x		4211815	CROSS AXLE 3M - ?? Material194??	8 x		4186017	CONNECTOR PEG/CROSS AXLE - ??Material5??	11 x		4225927	CONNECTOR PEG/CROSS AXLE - ?? Material23??
8 x		4211622	BUSH FOR CROSS AXLE - ??Material194??	1 x		4227155	BUSH FOR CROSS AXLE - ??Material21??	2 x		4189110	CONN.BUSH W.FRIC./CROSSALE - ?? Material23??





14 x  370526 CROSS AXLE 4M - ??
Material26??

12 x  655826 CONNECTOR PEG W.
FRICTION 3M - ??
Material26??

2 x  4514553 CONNECTOR PEG W.
FRICTION 3M - ??
Material23??

2 x  4514554 3M CONNECTOR PEG - ??
Material5??

16 x  4512360 CROSS AXLE,
EXTENSION, 2M - ??
Material194??

4 x  4513174 CROSS AXLE,
EXTENSION, 2M - ??
Material21??

1 x  4211639 CROSS AXLE 5M - ??
Material194??

6 x  4211775 CROSS BLOCK 90° - ??
Material194??

4 x  4107078 CROSS BLOCK 90° - ??
Material24??

4 x  4107085 ANGLE ELEMENT, 0
DEGREES [1] - ??
Material26??

1 x  4211550 ANGLE ELEMENT, 0
DEGREES [1] - ??
Material194??

6 x  4119033 ANGLE ELEMENT, 0
DEGREES [1] - ??
Material21??

4 x  4515184 BEAM 1X2 W/CROSS AND
HOLE - ??Material194??

8 x  75619 TUBE Ø7,84 2M - ??
Material26??

5 x  4212355 TUBE Ø7,84 2M - ??
Material194??

10 x 75854 TUBE Ø7,84 2M - ??
Material21??

6 x 75644 TUBE Ø7,84 2M - ??
Material24??

5 x 370626 CROSS AXLE 6M - ??
Material26??

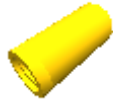

6 x

4211805 CROSS AXLE 7M - ??
Material194??

2 x

4211621 DOUBLE CROSS BLOCK -
??Material194??

5 x

4211779 CROSS BLOCK 3M - ??
Material194??

2 x

373726 CROSS AXLE 10M - ??
Material26??

2 x

4211880 HTO V BEAM 90 DEGR. -
??Material194??

7 x

370826 CROSS AXLE 12M - ??
Material26??

5 x

4211552 ANGLE ELEMENT, 157,5
DEGR. [3] - ??
Material194??

1 x

4211688 2X1X3 STEERING
KNUCKLE ARM - ??
Material194??

4 x

4538007 CROSS BLOCK 3X2 - ??
Material194??

9 x

4539880 BEAM FRAME 5X7 Ø 4.85 -
??Material194??

1 x

4580019 FLAT PANEL - ??
Material1??

4 x

4514559 GEAR WHEEL T=8, M=1 -
??Material199??

4 x

4211544 WEDGE-BELT WHEEL Ø24
- ??Material194??

1 x

4211565 GEAR WHEEL Z24 - ??
Material194??

3 x

4211433 GEAR WHEEL 40T - ??
Material194??

1 x

4269651 BASE PLATE 16X32 - ??
Material199??

1 x

4560729 BASE PLATE 32X32 - ??
Material199??

1 x

4580334 LEGO-TF,32X32
CROSSING NEW - ??
Material199??



© 2012 The LEGO Group. All rights reserved.
Use of the LEGO Digital Designer html print tool, signifies your agreement to the terms of use.