

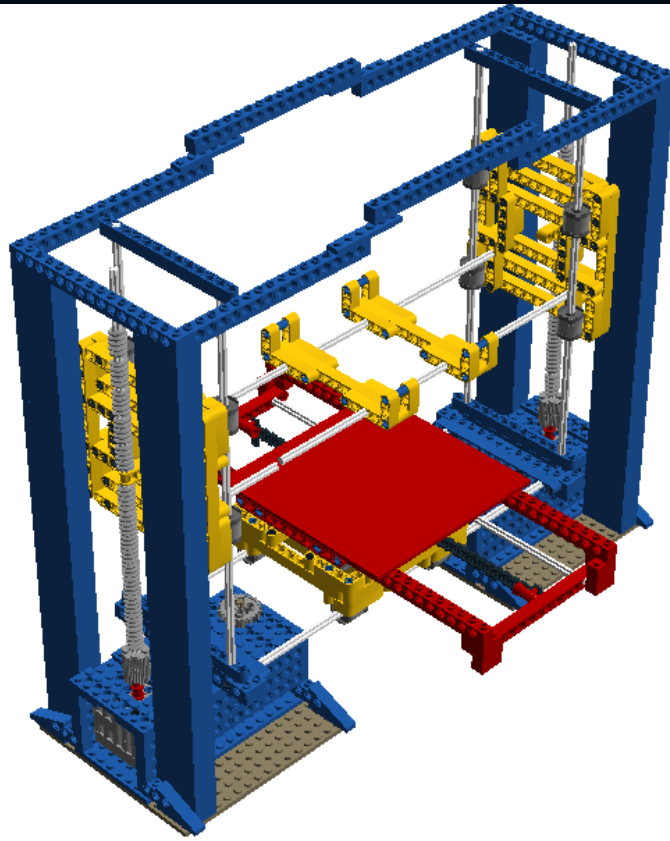

Model Name:
LEGO printer V2

Number of Bricks: 740



Step 1 of 275

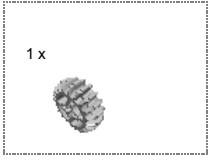

Step 2 of 275

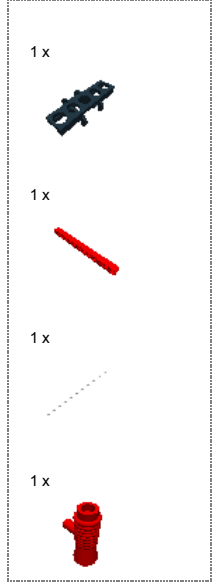

Step 3 of 275

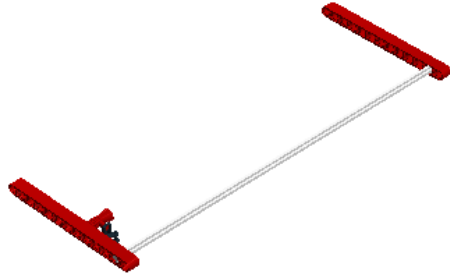
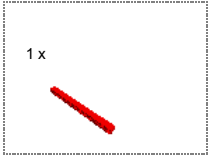

Step 4 of 275

2 x



1 x



Step 5 of 275



1

Step 6 of 275

3 x



1 x



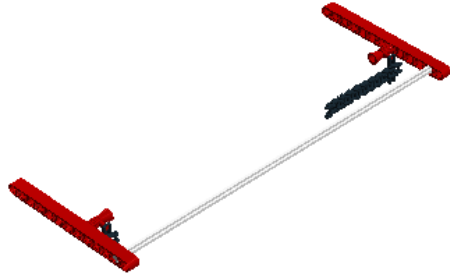

Step 8 of 275

2 x

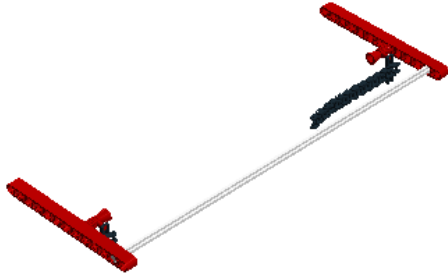

Step 9 of 275

1 x



2 x



1 x

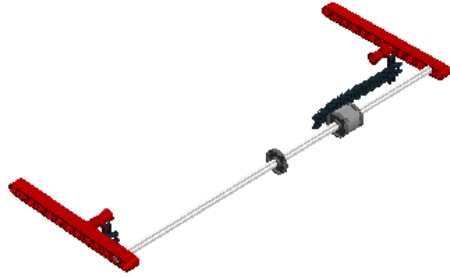

Step 10 of 275

1 x



1 x



2 x

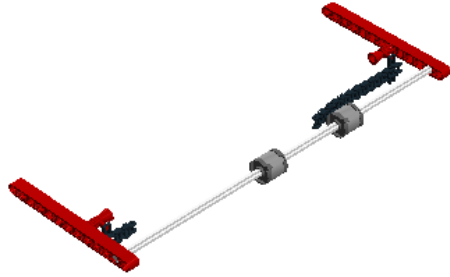

Step 11 of 275

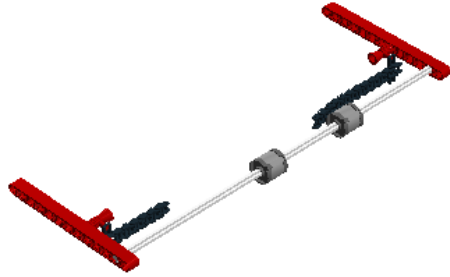

Step 12 of 275

4 x

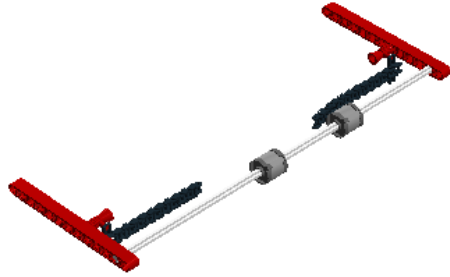

Step 13 of 275

1 x



1 x

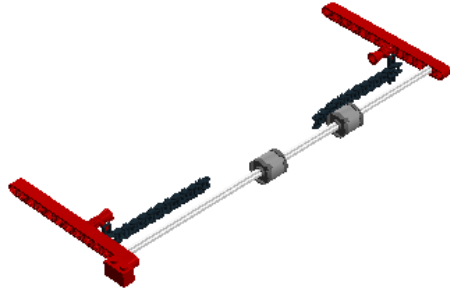

Step 14 of 275

1 x



1 x



1 x



Step 15 of 275

1 x



1 x



1 x



1 x

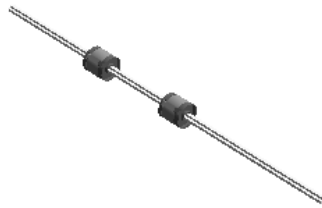

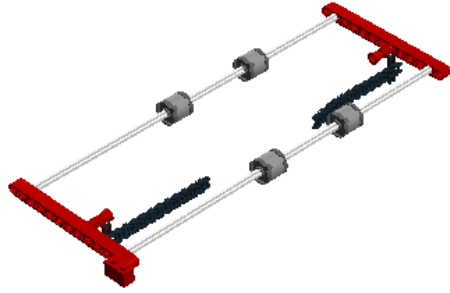

Step 17 of 275

1 x

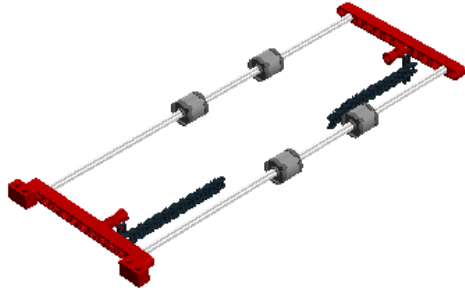

Step 18 of 275

2 x

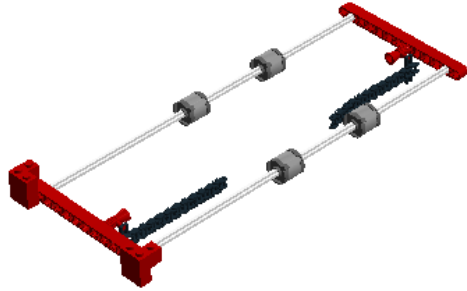

Step 19 of 275

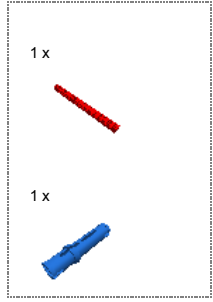

Step 20 of 275

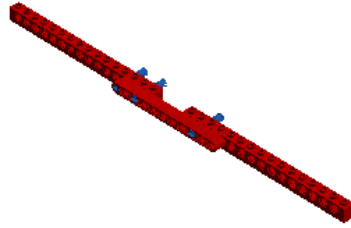
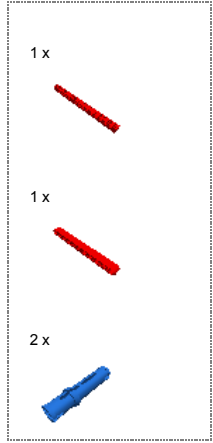

Step 21 of 275

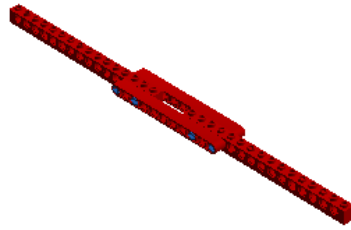
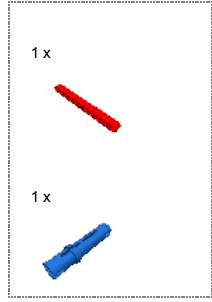

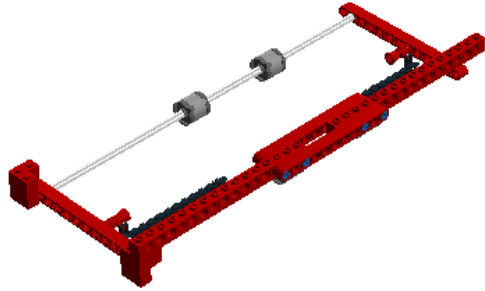

Step 23 of 275

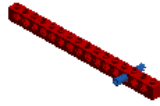
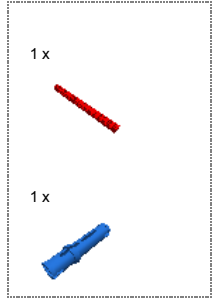

Step 24 of 275

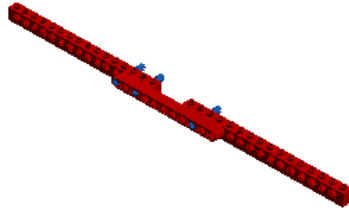
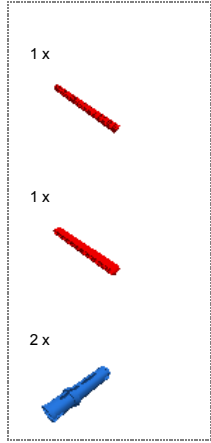

Step 25 of 275

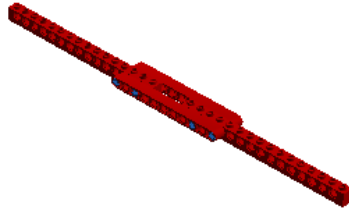
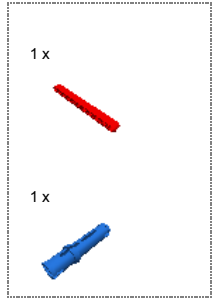

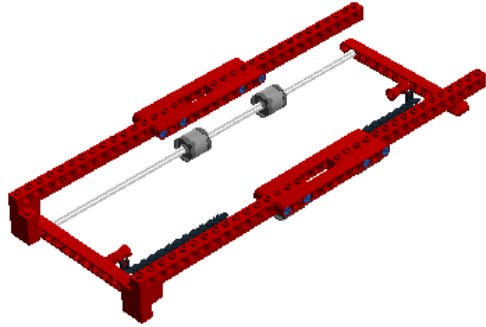

Step 27 of 275

2 x

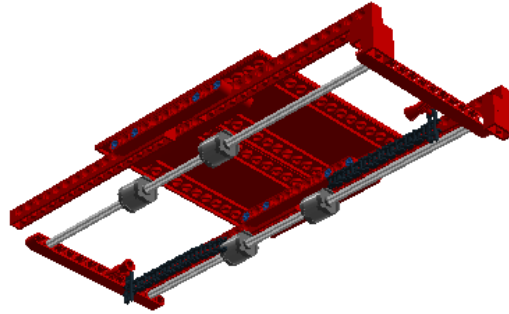

Step 28 of 275



1

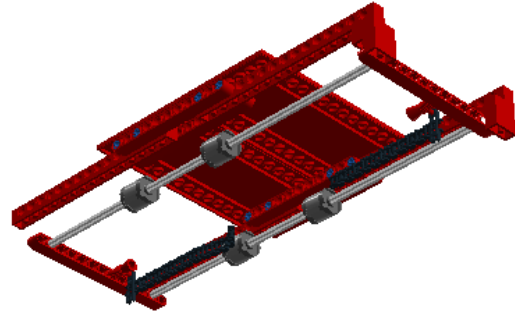

Step 30 of 275



2

Step 31 of 275



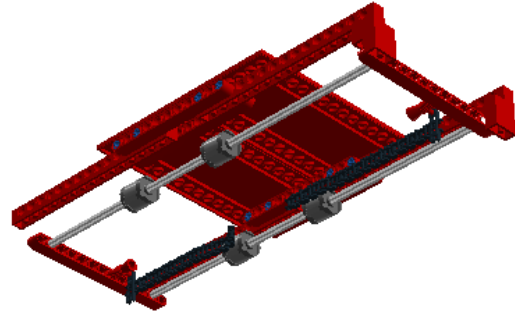

Step 33 of 275



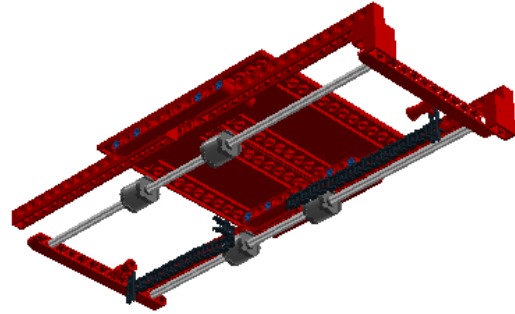

Step 35 of 275

1 x



1 x



2 x



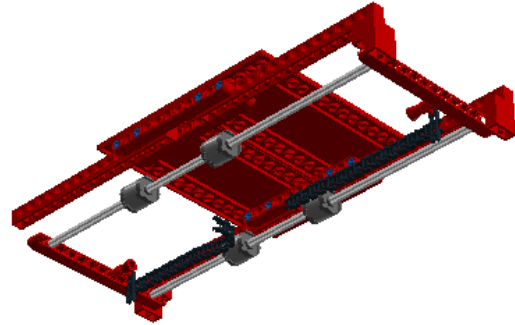

Step 37 of 275

1 x



1 x



2 x



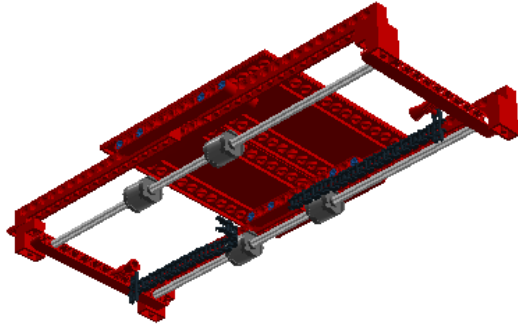

Step 39 of 275



Step 40 of 275



Step 41 of 275

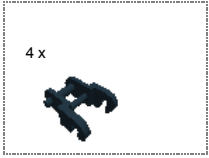

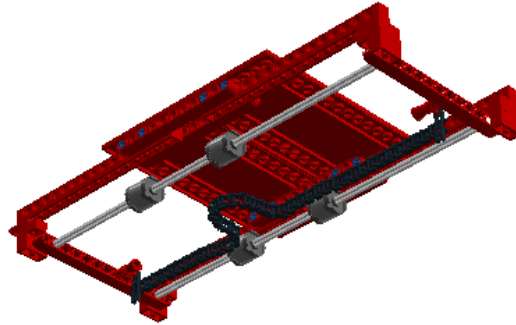

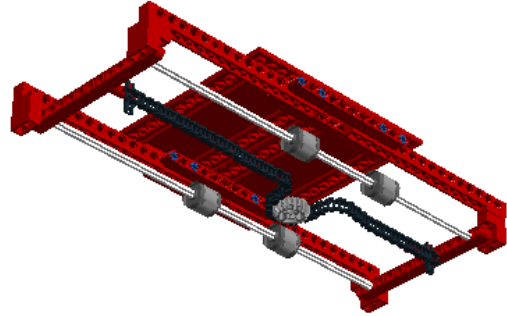

Step 44 of 275

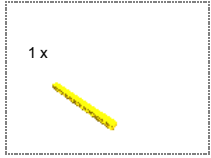

Step 45 of 275

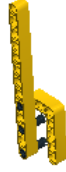
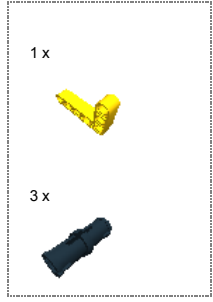

Step 46 of 275

1 x



1 x



2 x

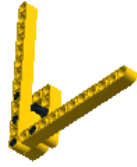

Step 47 of 275

1 x



1 x



2 x

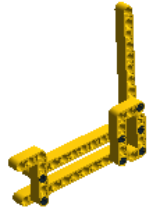

Step 48 of 275

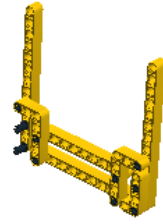
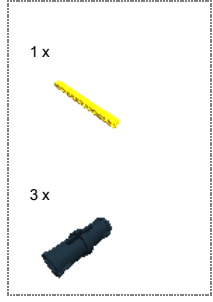

Step 49 of 275

1 x



3 x



Step 50 of 275

1 x



2 x



1 x

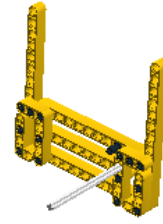

Step 51 of 275

1 x



2 x



1 x

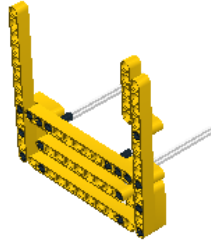

Step 52 of 275

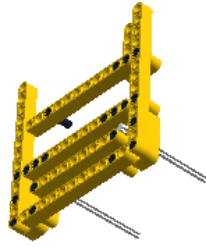
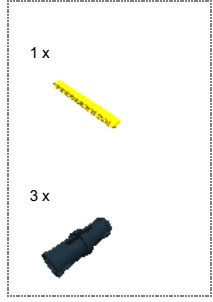

Step 53 of 275

1 x



3 x

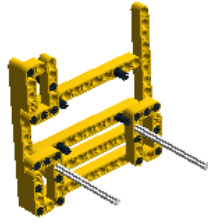

Step 54 of 275

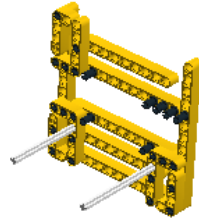
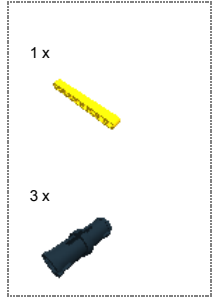

Step 55 of 275

1 x



2 x

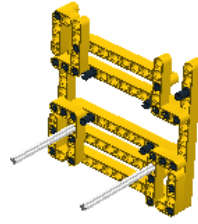

Step 56 of 275

1 x



3 x

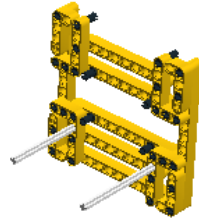

Step 57 of 275

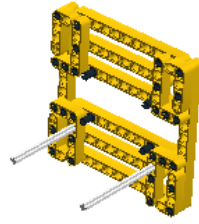
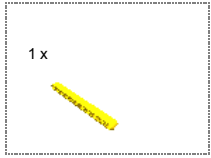

Step 58 of 275

1 x



2 x



Step 59 of 275

1 x



1 x



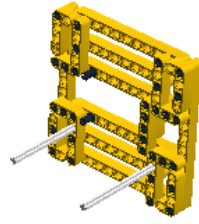

Step 61 of 275

1 x



2 x



Step 62 of 275

1 x



1 x



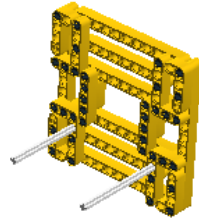

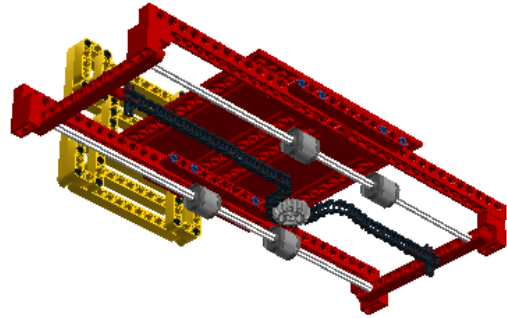

Step 65 of 275

1 x



Step 66 of 275

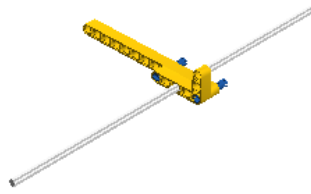
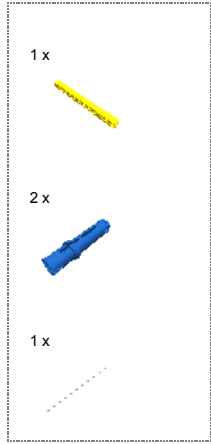

Step 67 of 275

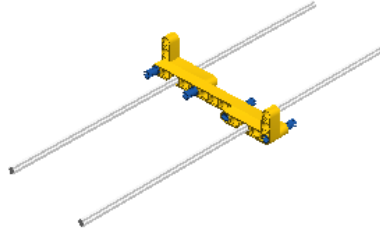
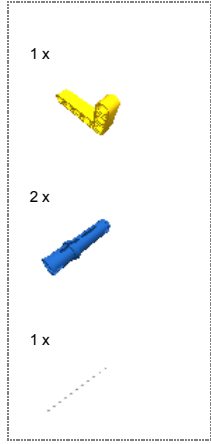

Step 68 of 275

3 x



1 x

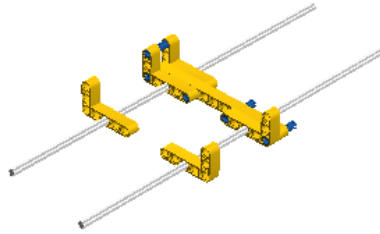

Step 69 of 275

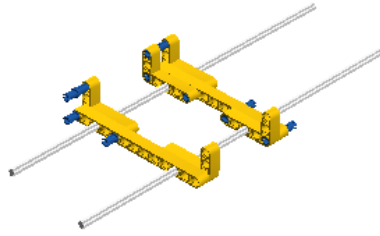
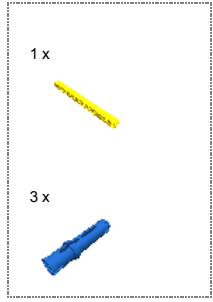

Step 70 of 275

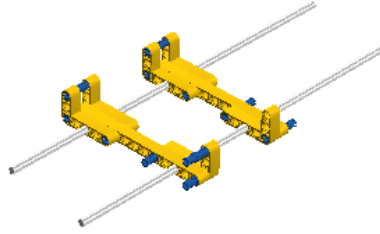
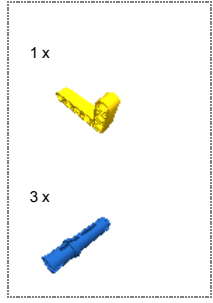

Step 71 of 275

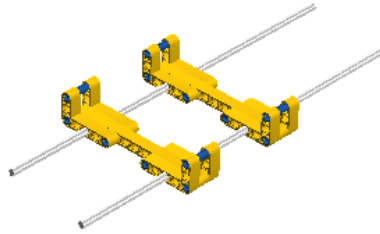
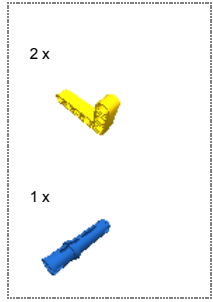

Step 72 of 275

1 x



1 x



2 x



Step 73 of 275

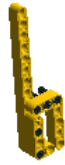
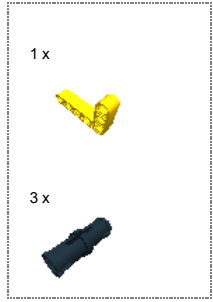

Step 74 of 275

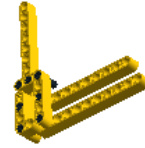
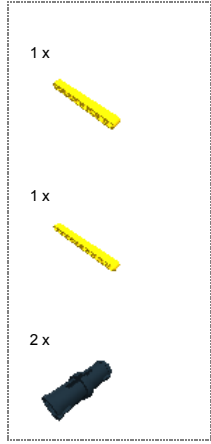

Step 75 of 275

1 x



3 x

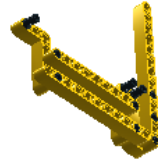

Step 76 of 275

1 x



1 x



2 x

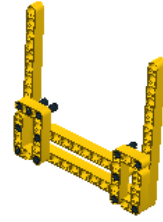

Step 77 of 275

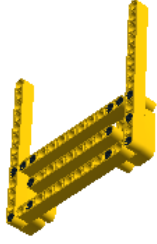
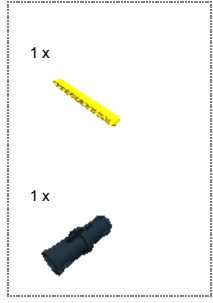

Step 78 of 275

1 x



3 x

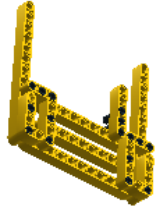

Step 79 of 275

1 x



1 x

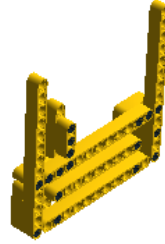

Step 80 of 275

1 x



3 x

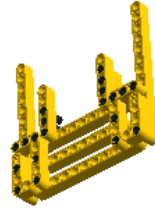

Step 81 of 275

1 x



2 x

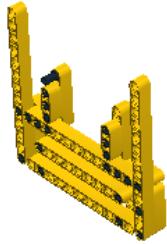

Step 82 of 275

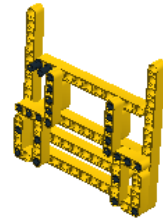
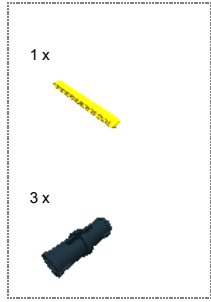

Step 83 of 275

1 x



1 x

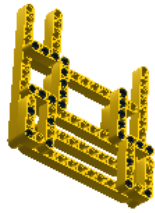

Step 84 of 275

1 x



3 x

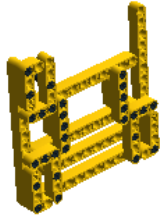

Step 85 of 275

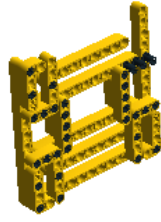
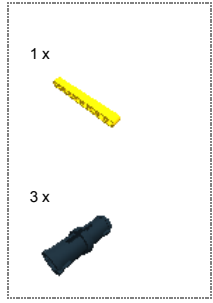

Step 86 of 275

1 x



3 x

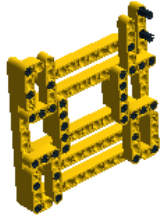

Step 87 of 275

1 x



1 x



2 x

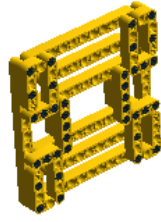

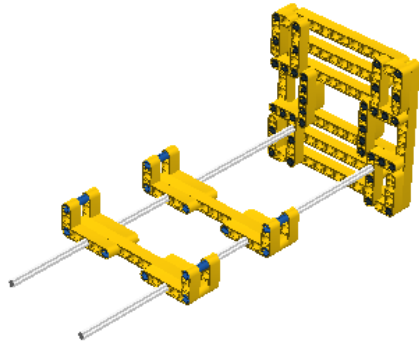

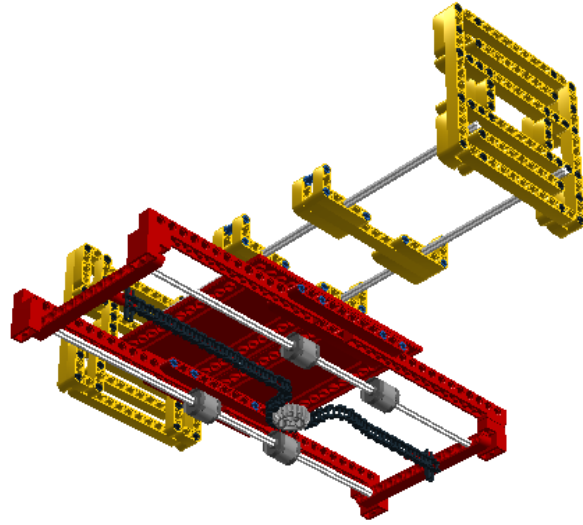

Step 90 of 275

1 x

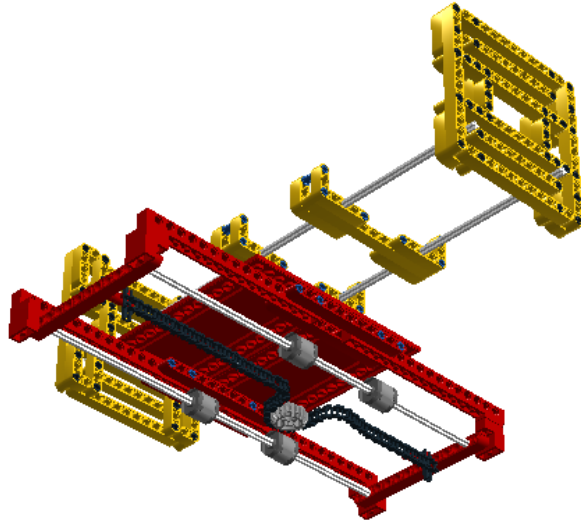

Step 91 of 275

1 x

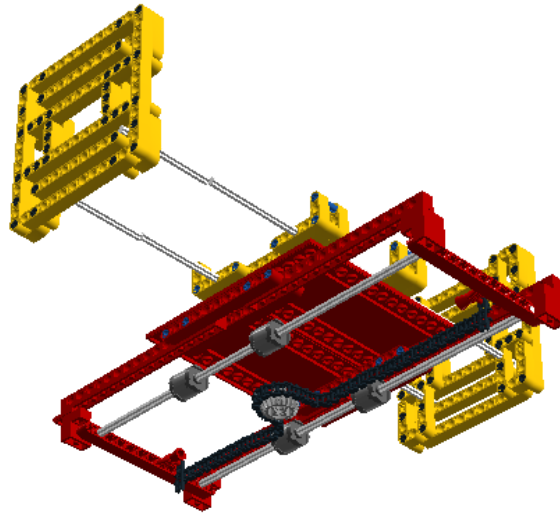

Step 92 of 275

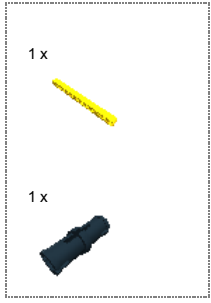

Step 93 of 275

1 x



1 x



1 x



1 x

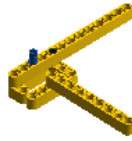

Step 94 of 275

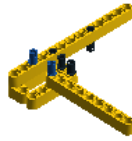
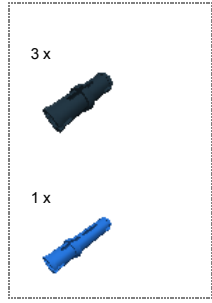

Step 95 of 275

1 x



1 x



2 x

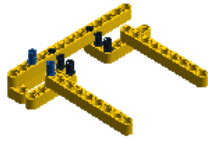

Step 96 of 275

1 x



3 x

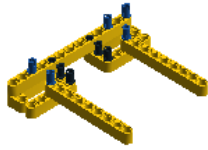

Step 97 of 275

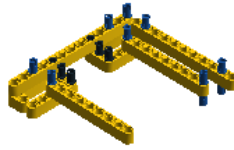
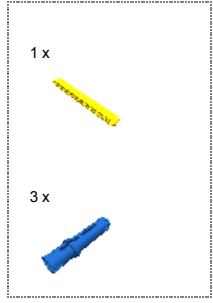

Step 98 of 275

1 x



3 x

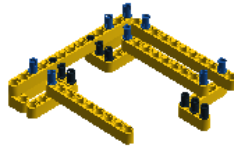

Step 99 of 275

1 x



1 x



1 x

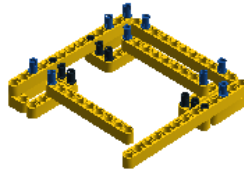

Step 100 of 275

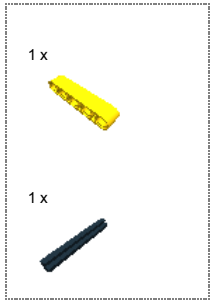

Step 101 of 275



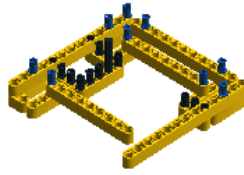

Step 103 of 275

1 x



1 x



Step 104 of 275

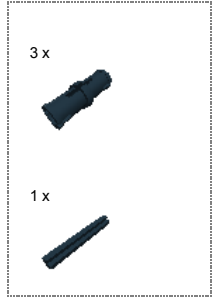

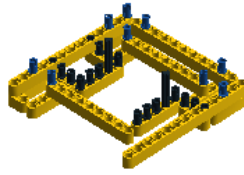

Step 106 of 275

1 x



1 x



1 x

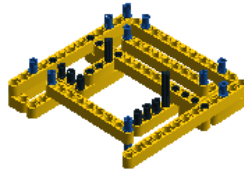

Step 107 of 275

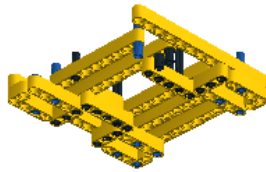
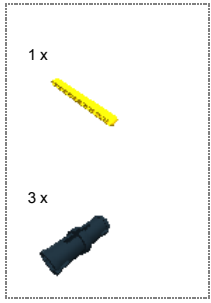

Step 108 of 275

1 x



3 x

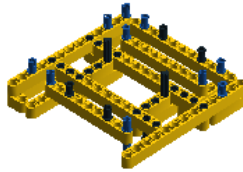

Step 109 of 275

1 x



1 x



2 x

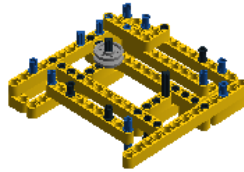

Step 110 of 275

1 x



1 x



2 x

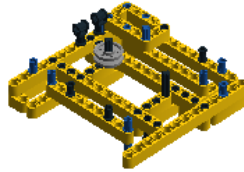

Step 111 of 275

1 x



1 x



1 x



1 x

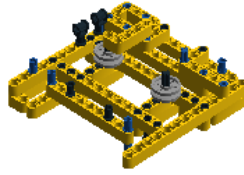

Step 112 of 275

1 x



1 x



2 x

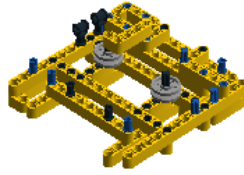

Step 113 of 275

1 x



1 x



2 x

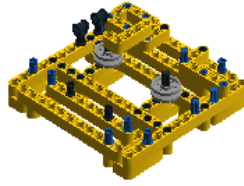

Step 114 of 275

2 x



2 x

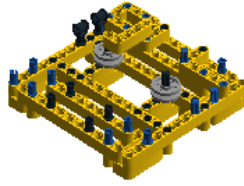

Step 115 of 275

1 x



1 x

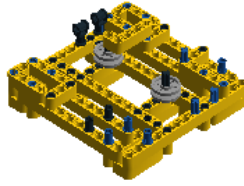

Step 116 of 275

1 x



1 x



2 x

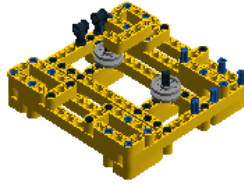

Step 117 of 275

2 x



2 x

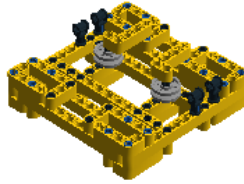

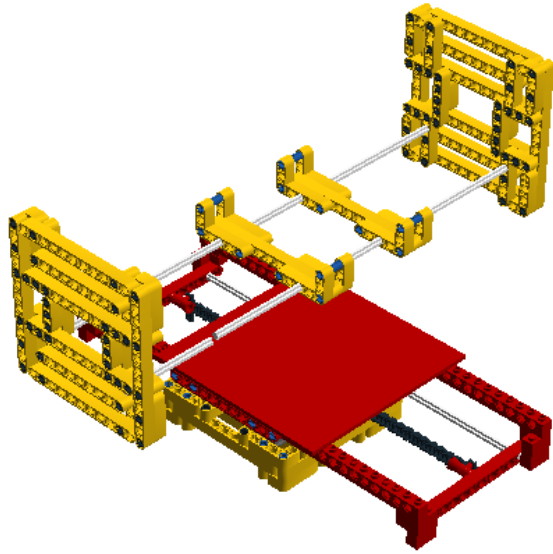

Step 119 of 275

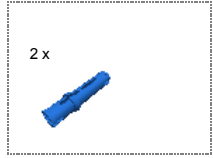

Step 120 of 275

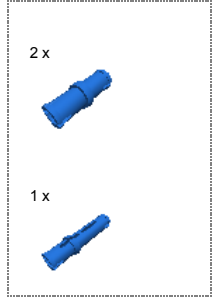

Step 121 of 275

1 x



1 x



Step 122 of 275

1 x



2 x



Step 123 of 275

2 x



1 x



1 x





Step 125 of 275

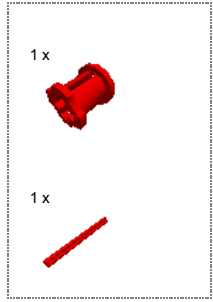

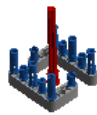

Step 127 of 275

2 x

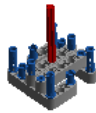

Step 128 of 275

1 x

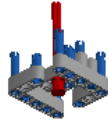

Step 129 of 275

1 x



1 x



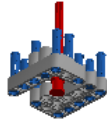

Step 131 of 275

1 x



1 x

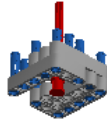

Step 132 of 275

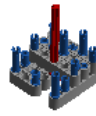
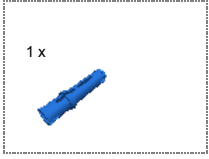

Step 133 of 275

2 x

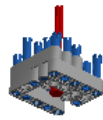

Step 134 of 275

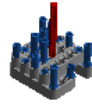
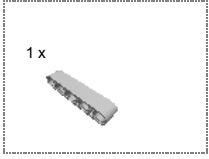

Step 135 of 275

2 x

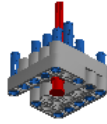

Step 136 of 275

1 x

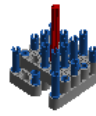

Step 137 of 275

1 x



1 x



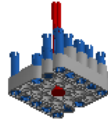

Step 139 of 275

1 x



1 x

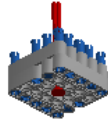

Step 140 of 275

1 x

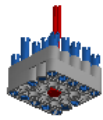

Step 141 of 275

1 x



2 x



1 x



Step 142 of 275

2 x

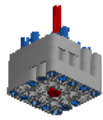

Step 143 of 275

1 x

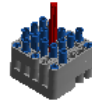

Step 144 of 275

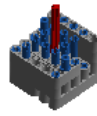
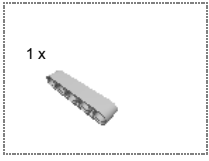

Step 145 of 275

1 x



1 x



1 x



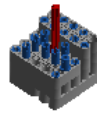

Step 147 of 275

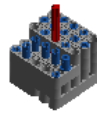
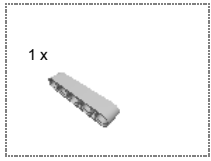

Step 148 of 275

1 x

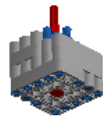

Step 149 of 275

1 x



1 x



1 x

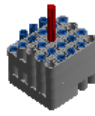

Step 150 of 275

1 x



1 x

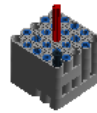

Step 151 of 275

1 x



1 x

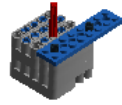

Step 152 of 275

1 x



1 x



2 x

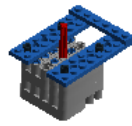

Step 153 of 275

2 x

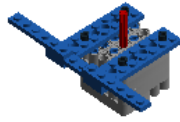

Step 154 of 275

1 x



1 x



Step 155 of 275

1 x



1 x



2 x

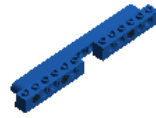

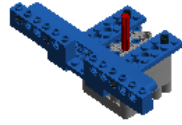

Step 157 of 275

3 x



1 x

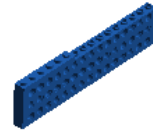

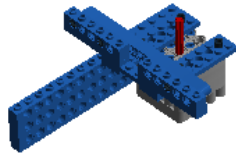

Step 159 of 275

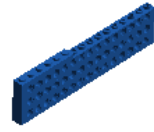
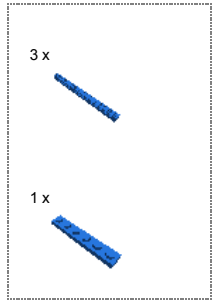

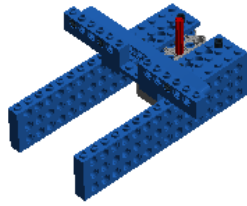

Step 161 of 275

2 x



1 x

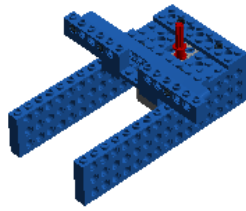

Step 162 of 275

2 x



1 x



1 x

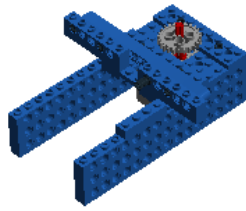

Step 163 of 275

1 x



1 x



2 x

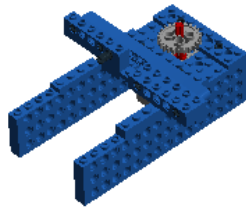

Step 164 of 275

1 x



1 x



1 x



1 x

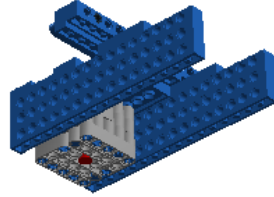

Step 165 of 275

2 x

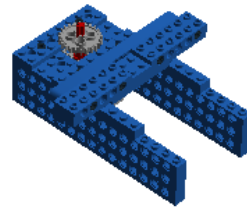

Step 166 of 275

1 x



1 x

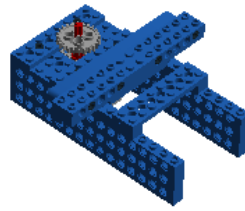

Step 167 of 275

3 x



1 x

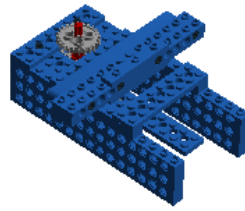

Step 168 of 275

3 x



1 x

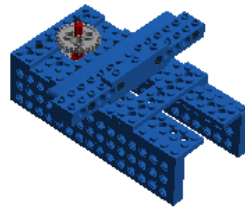

Step 169 of 275

2 x



1 x



1 x

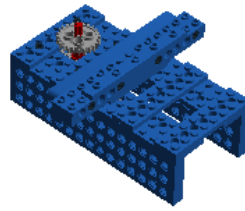

Step 170 of 275

1 x



1 x



1 x



Step 171 of 275

1 x



1 x



1 x



1 x

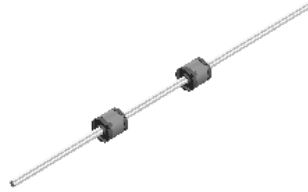

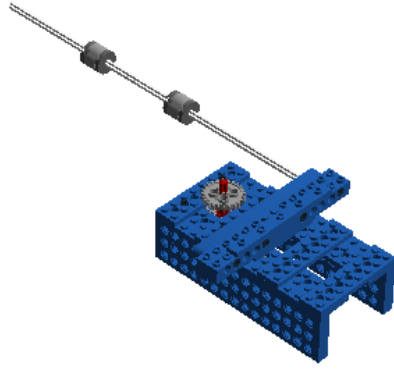

Step 173 of 275

1 x



1 x



1 x



Step 174 of 275

1 x



1 x



1 x



1 x



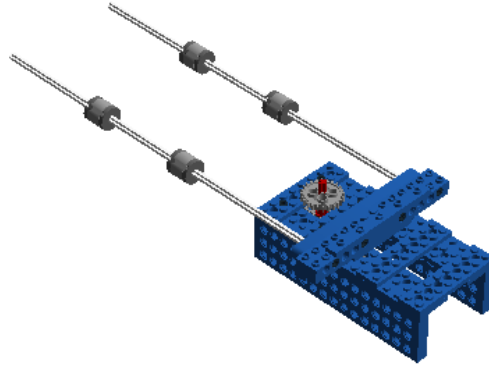

Step 176 of 275

1 x



1 x



1 x



Step 177 of 275

1 x



1 x



Step 178 of 275

1 x



1 x



1 x



1 x



Step 179 of 275

1 x



Step 180 of 275

2 x



1 x



1 x



Step 181 of 275

1 x



1 x



2 x



Step 182 of 275

2 x



1 x



1 x



Step 183 of 275

1 x



3 x

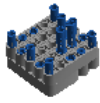

Step 184 of 275

4 x

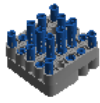

Step 185 of 275

1 x



1 x



2 x

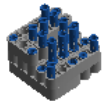

Step 186 of 275

1 x



1 x



1 x



1 x

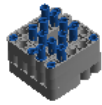

Step 187 of 275

1 x



1 x



2 x

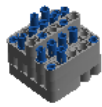

Step 188 of 275

2 x



2 x

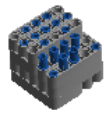

Step 189 of 275

2 x



2 x



Step 190 of 275



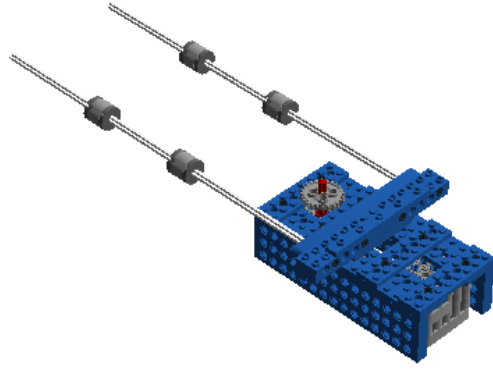

Step 192 of 275

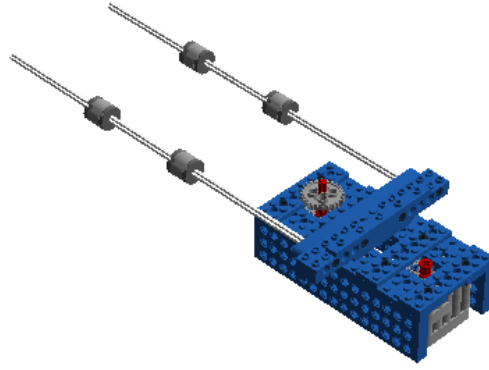
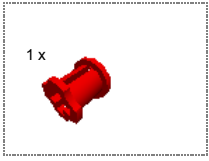

Step 193 of 275

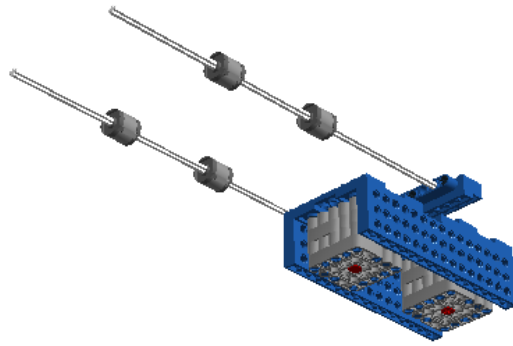
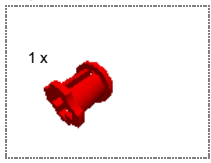

Step 194 of 275

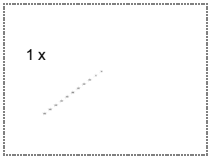

Step 195 of 275

2 x



Step 196 of 275

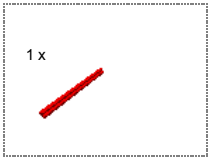

Step 197 of 275

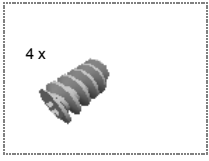

Step 198 of 275

1 x



3 x



Step 199 of 275

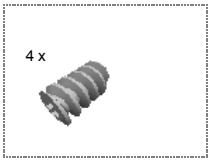

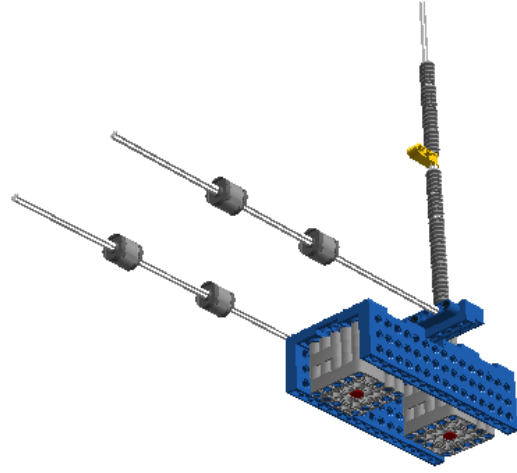

Step 201 of 275

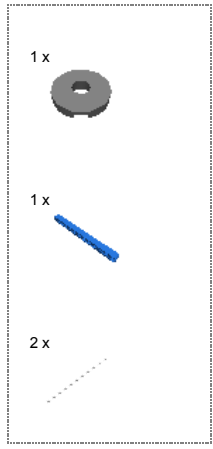

Step 202 of 275

2 x



1 x



1 x



Step 203 of 275

1 x



1 x



2 x



Step 204 of 275

1 x



1 x



1 x



1 x



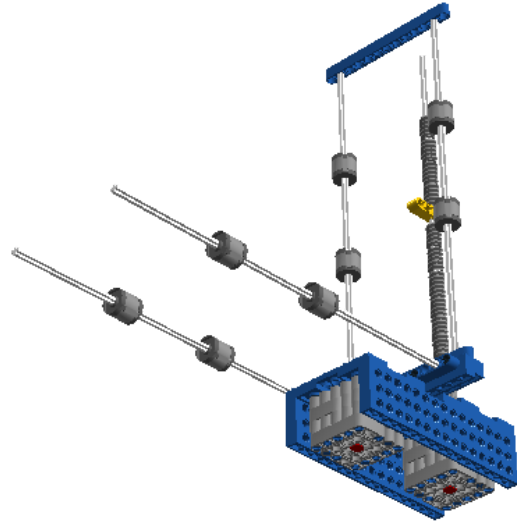

Step 206 of 275

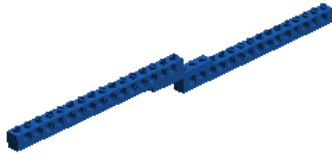
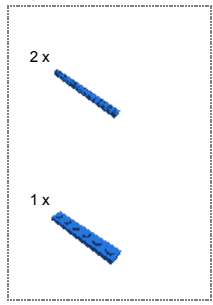

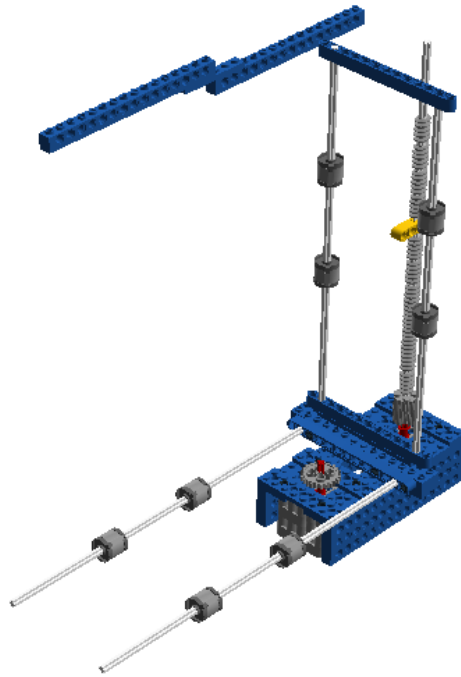

Step 208 of 275

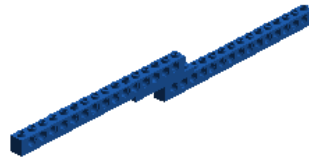
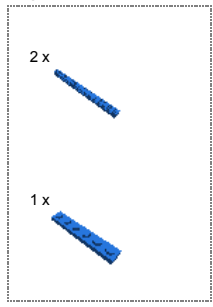

Step 209 of 275

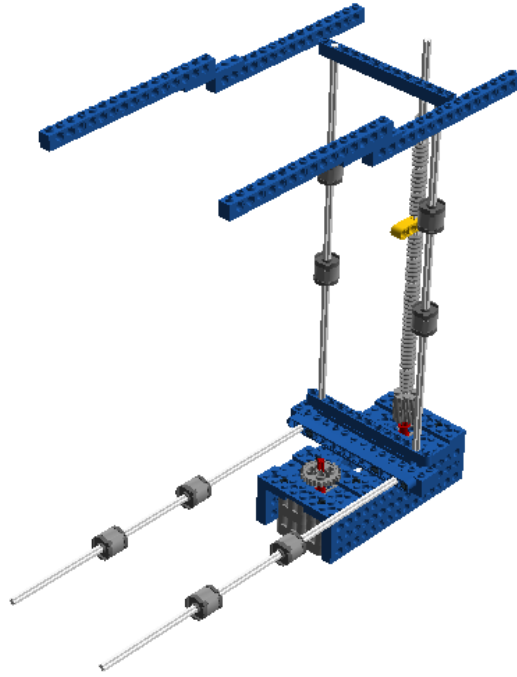

Step 210 of 275

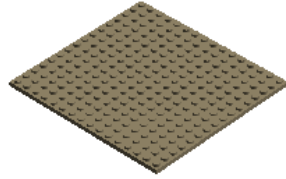
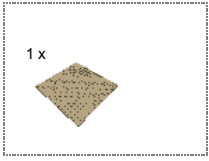

Step 211 of 275

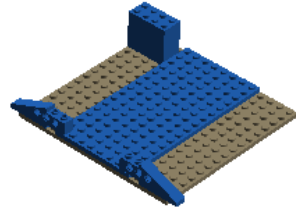
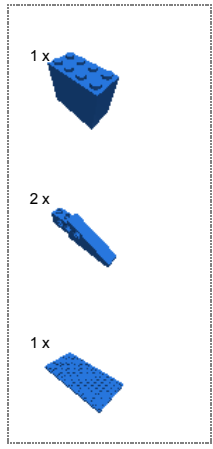

Step 212 of 275

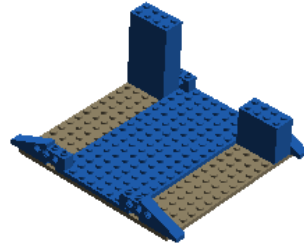
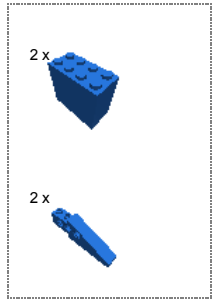

Step 213 of 275

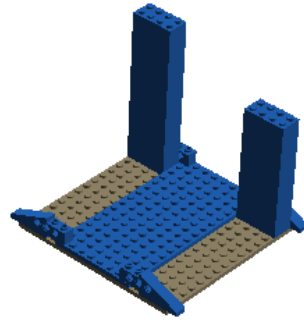
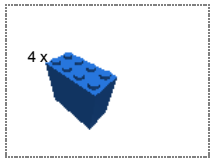

Step 214 of 275

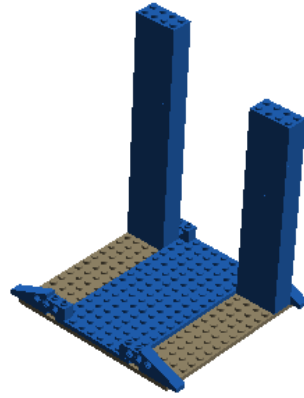
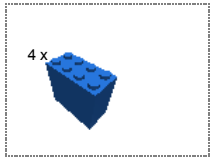

Step 215 of 275

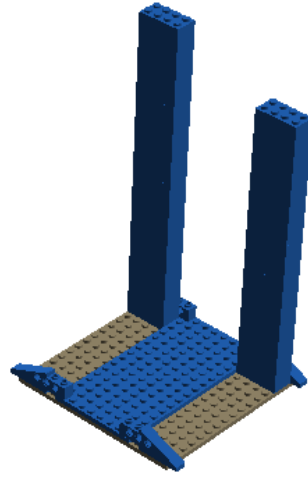
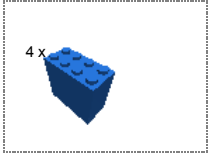

Step 216 of 275

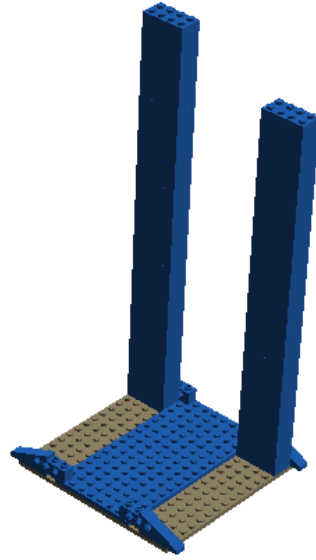
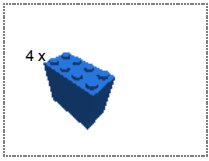

Step 217 of 275

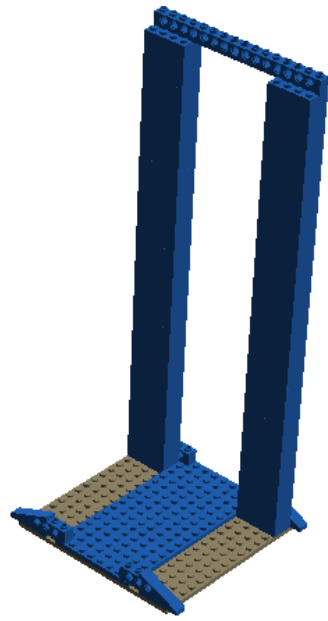
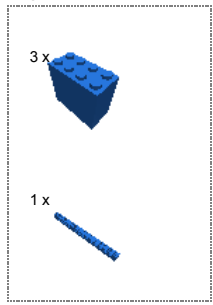

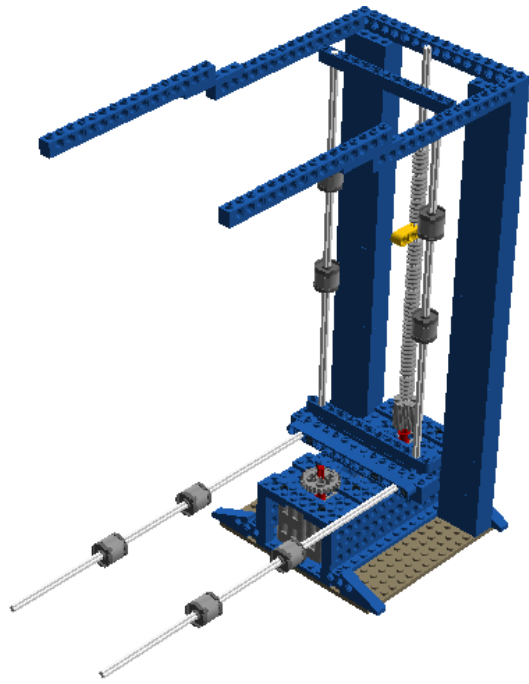

Step 219 of 275

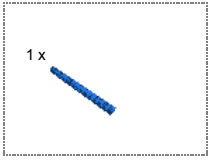

Step 220 of 275

2 x



2 x



Step 221 of 275

1 x



1 x



1 x



1 x

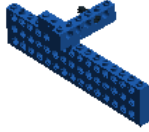

Step 222 of 275

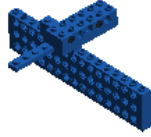
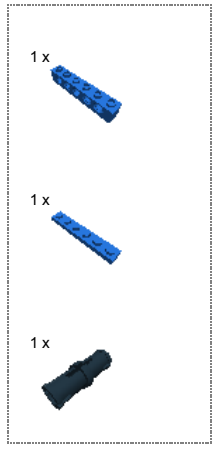

Step 223 of 275

1 x



1 x



1 x



1 x

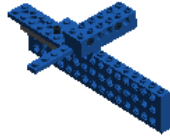

Step 224 of 275

1 x

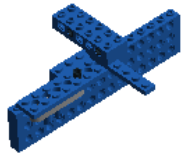

Step 225 of 275

1 x



1 x



1 x



1 x

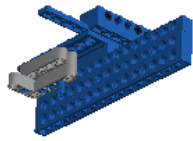

Step 226 of 275

1 x



1 x



1 x

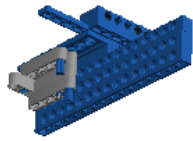

Step 227 of 275

1 x



1 x

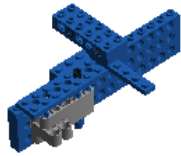

Step 228 of 275

2 x

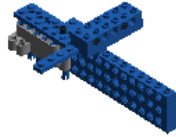

Step 229 of 275

1 x



1 x

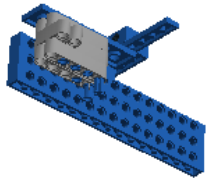

Step 230 of 275

1 x



1 x



1 x



1 x

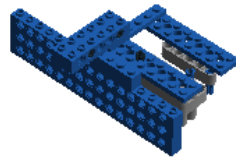

Step 231 of 275

1 x

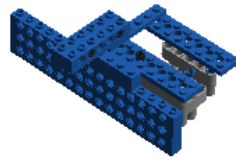

Step 232 of 275

2 x



1 x

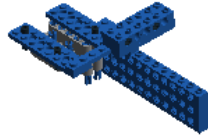

Step 233 of 275

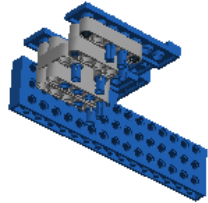

Step 234 of 275

1 x



1 x



1 x



1 x

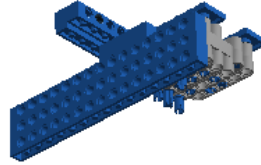

Step 235 of 275

2 x

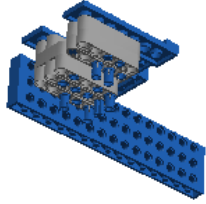

Step 236 of 275

1 x



1 x



2 x

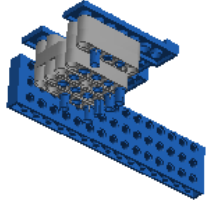

Step 237 of 275

1 x



1 x

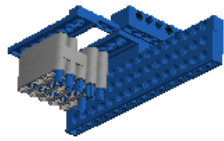

Step 238 of 275

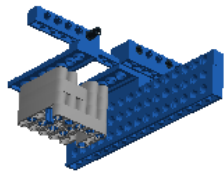

Step 239 of 275

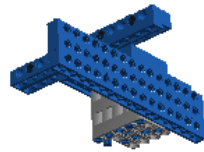
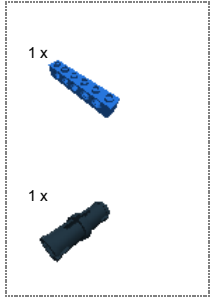

Step 240 of 275

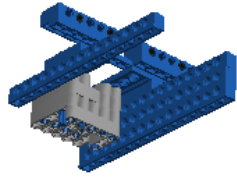
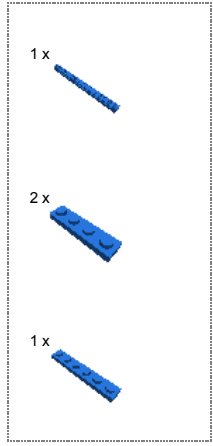

Step 241 of 275

2 x



1 x



1 x

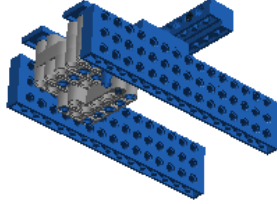

Step 242 of 275

1 x



1 x



2 x

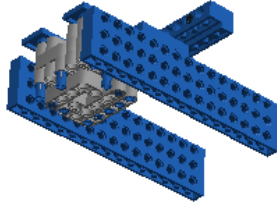

Step 243 of 275

2 x

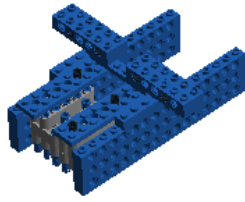

Step 244 of 275

2 x



1 x



1 x

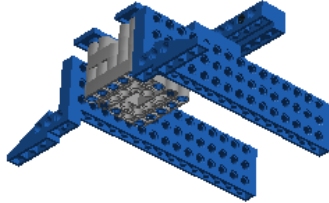

Step 245 of 275

2 x



1 x



1 x

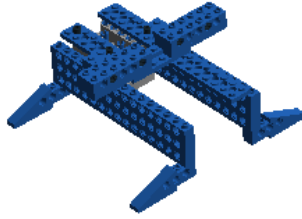

Step 246 of 275

1 x



1 x

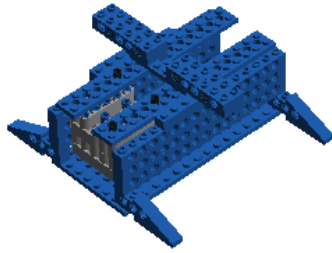

Step 247 of 275

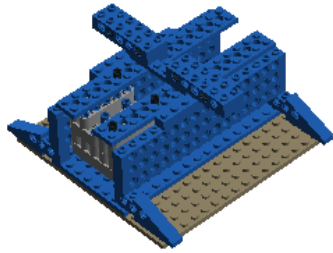
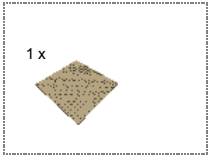

Step 248 of 275

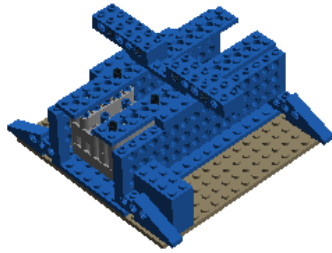
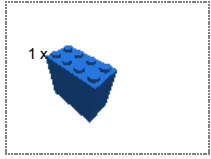

Step 249 of 275

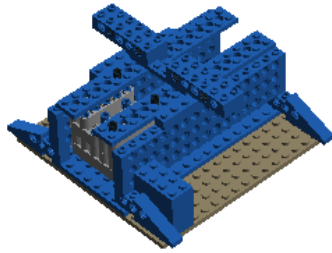
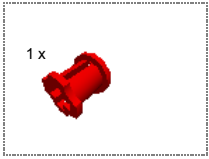

Step 250 of 275

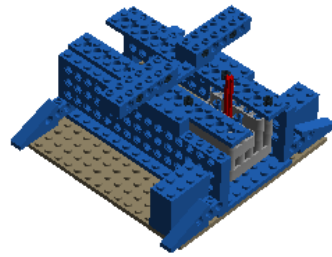
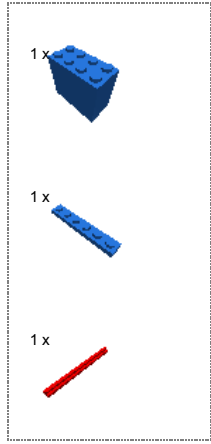

Step 251 of 275

2 x



1 x



1 x

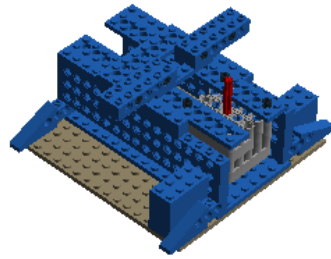

Step 252 of 275

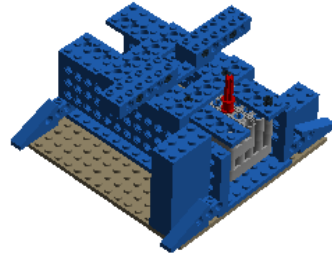

Step 253 of 275

2 x



1 x

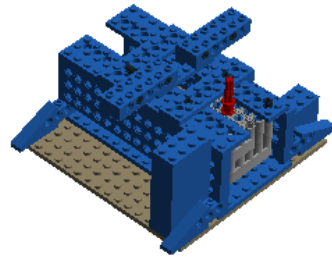

Step 254 of 275

1 x



3 x

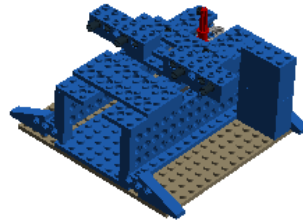

Step 255 of 275

1 x



1 x



1 x

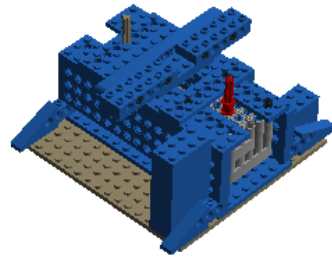

Step 256 of 275

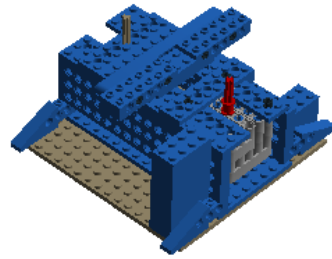
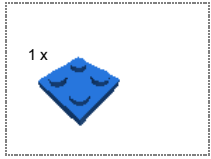

Step 257 of 275

2 x



1 x

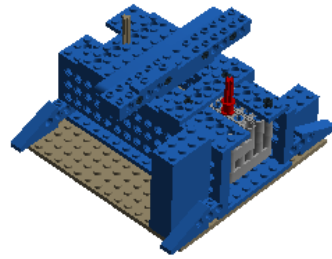

Step 258 of 275

2 x



1 x



1 x

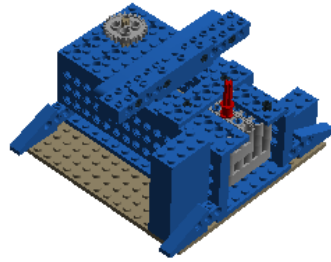

Step 259 of 275

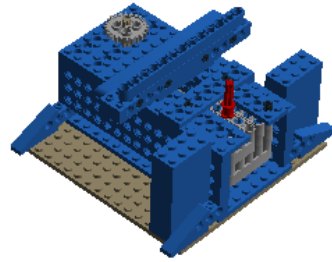
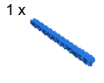
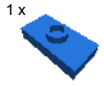

Step 260 of 275

2 x



1 x



1 x

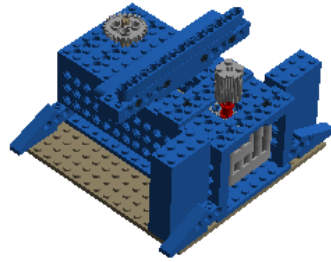

Step 261 of 275

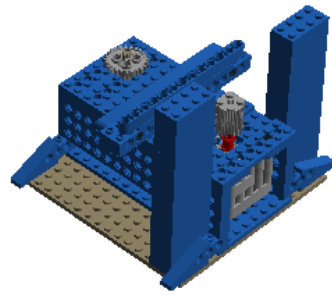
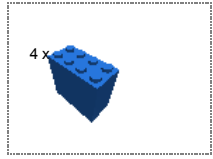

Step 262 of 275

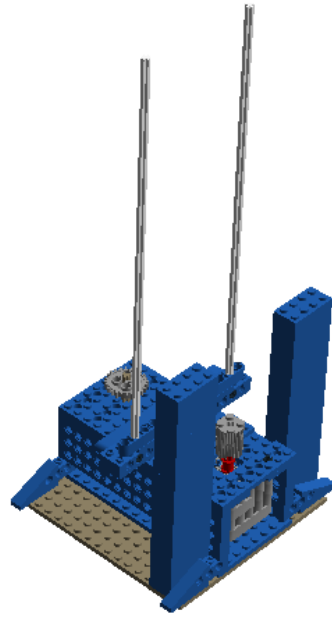
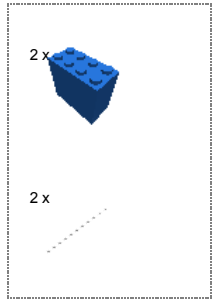

Step 263 of 275

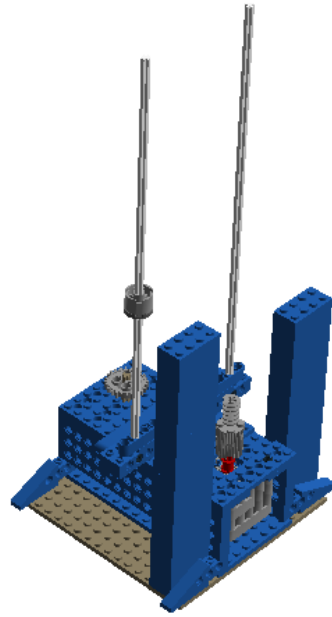
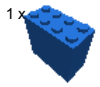

Step 264 of 275

4 x

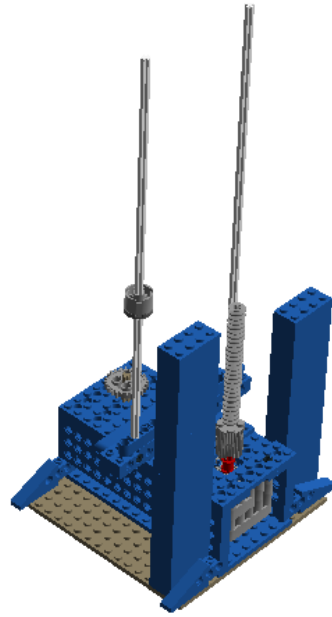

Step 265 of 275

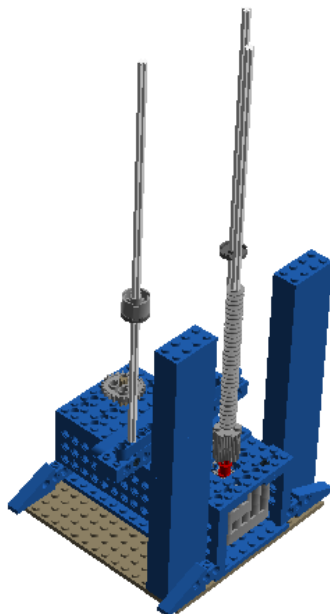

Step 266 of 275

1 x



2 x



1 x

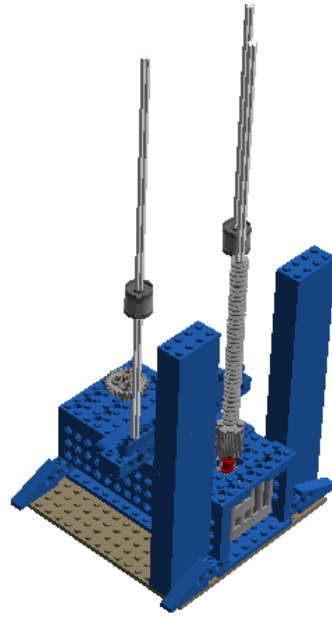



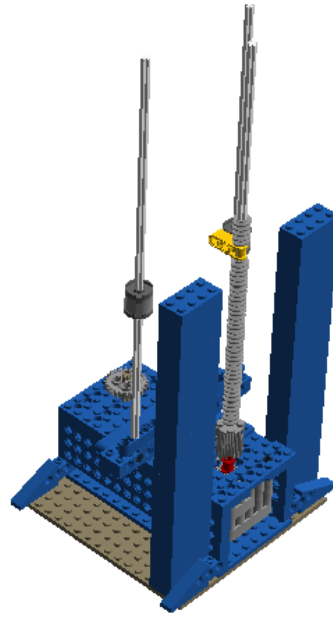
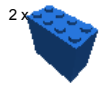

Step 267 of 275

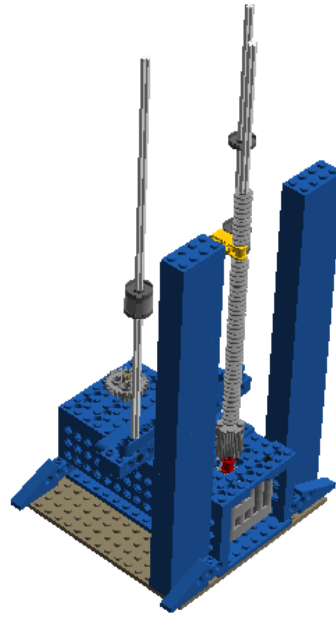

Step 268 of 275



Step 269 of 275

- 1 x 
- 1 x 
- 1 x 
- 1 x 

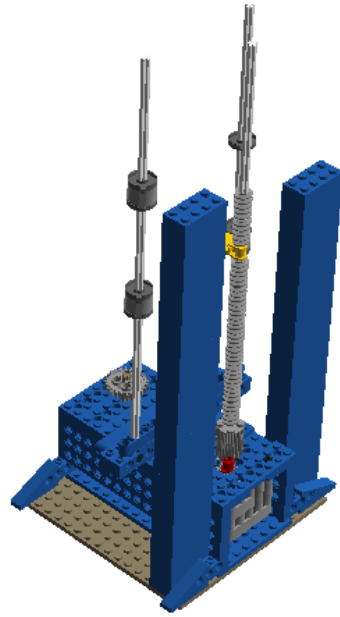

Step 270 of 275

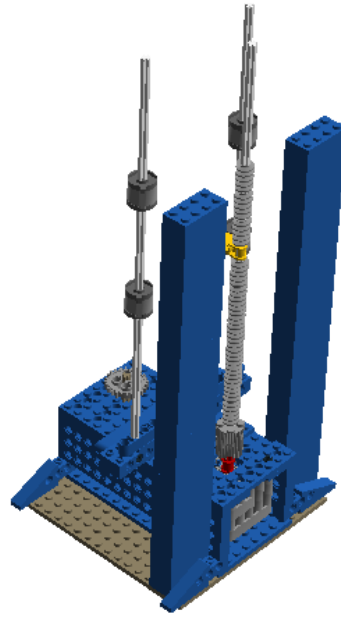

Step 271 of 275

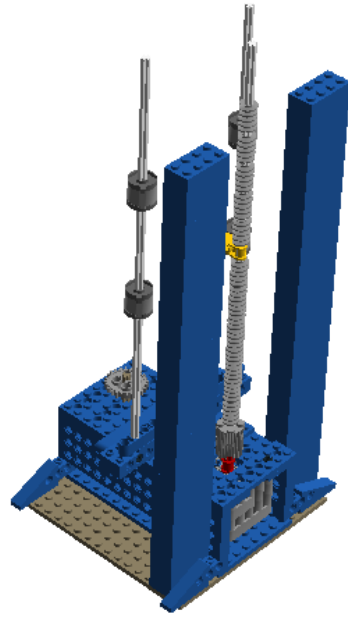
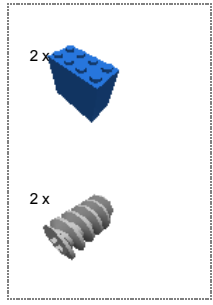

Step 272 of 275

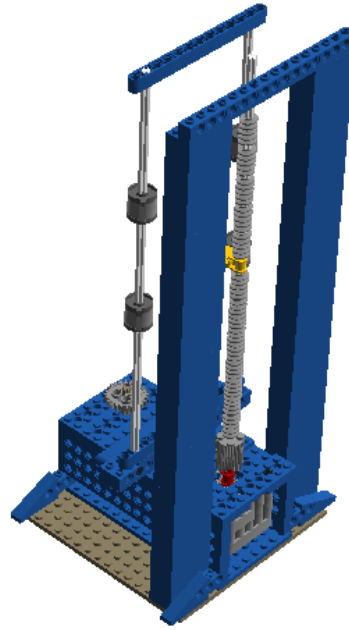
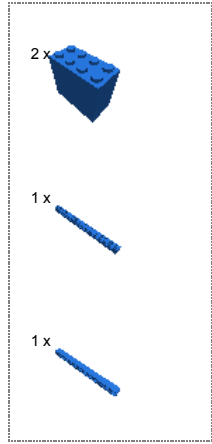



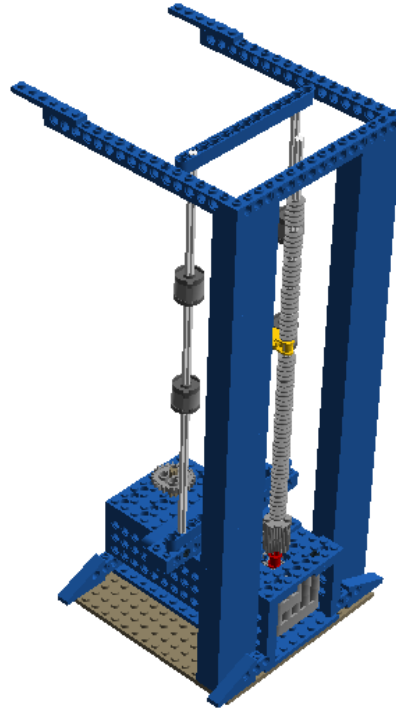
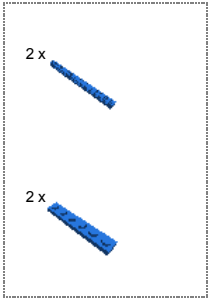

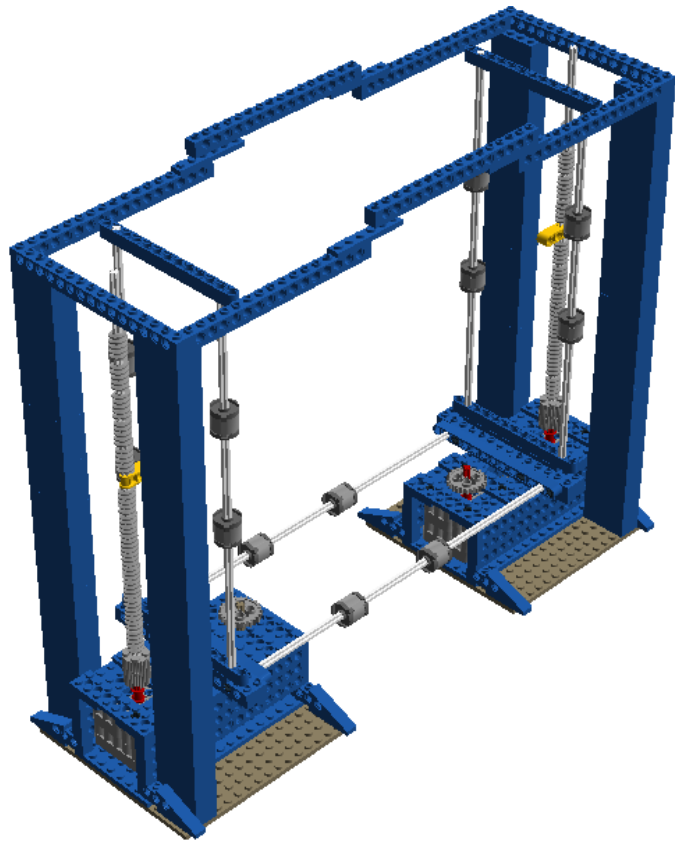

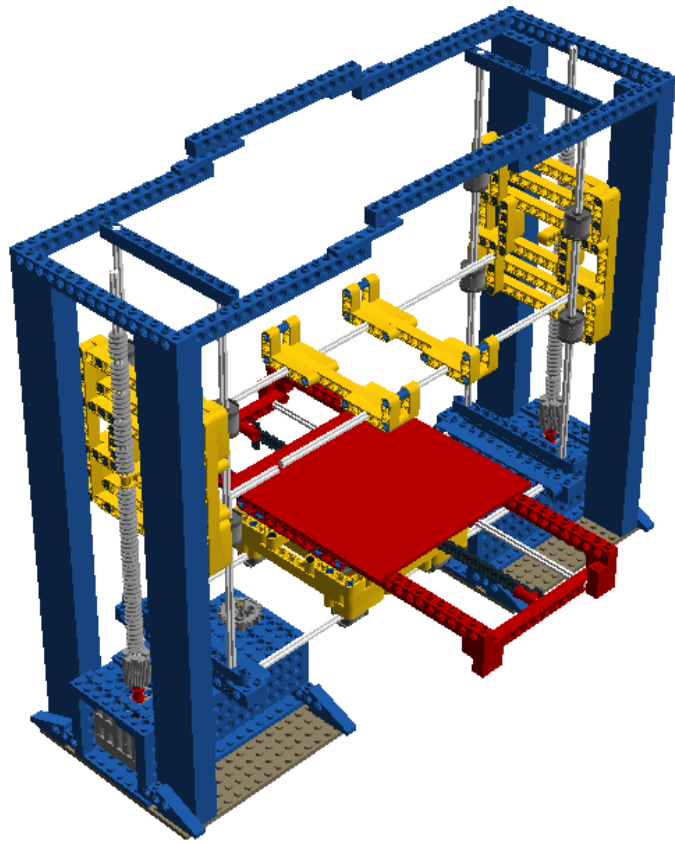















































Step 273 of 275







2 x		235721 BRICK CORNER 1X2X2 - Bright Red	44 x		6031391 BRICK 2X4X3 - Bright Blue	16 x		4211526 BRICK Ø16 W. CROSS - Medium Stone Grey
4 x		4610816 PROFILE BRICK Ø15.83 W. CROSS - Medium Stone Grey	4 x		245821 BRICK 1X2 W. HORIZONTAL SNAP - Bright Red	8 x		389423 TECHNIC BRICK 1X6, Ø4.9 - Bright Blue
8 x		4101798 WING SECTION, REAR - Bright Blue	4 x		370321 TECHNIC BRICK 1X16, Ø4.9 - Bright Red	20 x		370323 TECHNIC BRICK 1X16, Ø4.9 - Bright Blue
2 x		306921 FLAT TILE 1X2 - Bright Red	10 x		379423 PLATE 1X2 W. 1 KNOB - Bright Blue	4 x		242021 CORNER PLATE 1X2X2 - Bright Red
6 x		302223 PLATE 2X2 - Bright Blue	18 x		371023 PLATE 1X4 - Bright Blue	17 x		366623 PLATE 1X6 - Bright Blue
2 x		4242525 FLAT TILE 8X16 - Bright Red	2 x		4610354 PLATE 8X16 - Bright Blue	2 x		4613196 PLATE 16X16 - Sand Yellow
16 x		6055313 FLAT TILE 2x2 ROUND W. HOLE Ø4.85 - Dark Stone Grey	16 x		4211042 PLATE 2X2 ROUND - Dark Stone Grey	17 x		373823 PLATE 2X8 W. HOLES - Bright Blue
42 x		371126 CHAIN LINK M=1 - Black	2 x		6047885 CHAINS M PLATE M 5 Ø3, 2 HOLE - Black	2 x		6044729 RIM NARROW Ø18x7 W. HOLE Ø4.8 - Medium Stone Grey
6 x		4153707 TECHNIC 3M BEAM - Bright Yellow	30 x		4211651 TECHNIC 5M BEAM - Medium Stone Grey	6 x		4128590 TECHNIC 5M BEAM - Bright Yellow
12 x		4211610 TECHNIC ANG. BEAM 4X2 90 DEG - Medium Stone Grey	18 x		4141628 TECHNIC ANG. BEAM 4X2 90 DEG - Bright Yellow	6 x		4170505 TECHNIC 9M BEAM - Bright Yellow
4 x		4205035 TECHNIC 11M BEAM - Bright Red	12 x		4174709 TECHNIC 11M BEAM - Bright Yellow	2 x		4262082 TECHNIC 13M BEAM - Bright Red
8 x		4237328 TECHNIC 13M BEAM - Bright Yellow	6 x		4193421 TECHNIC 13M BEAM - Bright Blue	12 x		4211713 TECHNIC ANG. BEAM 3X5 90 DEG. - Medium Stone Grey
24 x		4144022 TECHNIC ANG. BEAM 3X5 90 DEG. - Bright Yellow	2 x		4211573 1/2 BUSH - Medium Stone Grey	126 x		278026 CONNECTOR PEG W. FRICTION - Black

- | | | | | | | | | |
|------|---|--|-----|---|---|------|---|---|
| 30 x |  | 4129886 CONNECTOR PEG -
Bright Blue | 6 x |  | 4225927 CONNECTOR PEG/CROSS
AXLE - Bright Blue | 6 x |  | 4227155 BUSH FOR CROSS AXLE -
Bright Red |
| 18 x |  | 4189110 CONN.BUSH
W.FRIC./CROSSALE -
Bright Blue | 2 x |  | 370526 CROSS AXLE 4M - Black | 84 x |  | 4514553 CONNECTOR PEG W.
FRICTION 3M - Bright Blue |
| 1 x |  | 4566927 CROSSAXLE 3M WITH
KNOB - Sand Yellow | 4 x |  | 4107081 CATCH W. CROSS HOLE -
Black | 3 x |  | 4267859 CROSS AXLE 7M - Bright
Red |
| 2 x |  | 370701 CROSS AXLE 8M - White | 2 x |  | 4175441 CROSS BLOCK 3M - Bright
Yellow | 12 x |  | 4233215 CROSS AXLE 32M - White |
| 23 x |  | 4211510 WORM - Medium Stone
Grey | 1 x |  | 4211635 DOUBLE CONICAL WHEEL
Z20 1M - Medium Stone
Grey | 2 x |  | 4211565 GEAR WHEEL Z24 -
Medium Stone Grey |
| 2 x |  | 434921 MEGAPHONE - Bright Red | | | | | | |