

SPECIFICATION FOR APPROVAL

- () Preliminary Specification
 (◆) Final Specification

Title	14.0"W HD+ TFT LCD
-------	--------------------

Customer	HP
MODEL	

SUPPLIER	LG Display Co., Ltd.
*MODEL	LP140WD1
Suffix	TLD2

*When you obtain standard approval,
 please use the above model name without suffix

APPROVED BY	SIGNATURE
/	_____
/	_____
/	_____

Please return 1 copy for your confirmation with your signature and comments.

APPROVED BY	SIGNATURE
G. J. Kwon / S.Manager	_____
REVIEWED BY	
S. R. Kim / Manager	_____
PREPARED BY	
D. G. Choi / Engineer	_____

Products Engineering Dept.
 LG Display Co., Ltd

Contents

No	ITEM	Page
	COVER	1
	CONTENTS	2
	RECORD OF REVISIONS	3
1	GENERAL DESCRIPTION	4
2	ABSOLUTE MAXIMUM RATINGS	5
3	ELECTRICAL SPECIFICATIONS	
3-1	ELECTRICAL CHARACTERISTICS	6-7
3-2	INTERFACE CONNECTIONS	8
3-3	LVDS SIGNAL TIMING SPECIFICATION	9-10
3-4	SIGNAL TIMING SPECIFICATIONS	11
3-5	SIGNAL TIMING WAVEFORMS	11
3-6	COLOR INPUT DATA REFERENCE	12
3-7	POWER SEQUENCE	13
4	OPTICAL SPECIFICATIONS	14-16
5	MECHANICAL CHARACTERISTICS	17-23
6	RELIABILITY	24
7	INTERNATIONAL STANDARDS	
7-1	SAFETY	25
7-2	EMC	25
7-3	Environment	25
8	PACKING	
8-1	DESIGNATION OF LOT MARK	26
8-2	PACKING FORM	26
9	PRECAUTIONS	27-28
A	APPENDIX. Enhanced Extended Display Identification Data	29-31

Product Specification

1. General Description

The LP140WD1 is a Color Active Matrix Liquid Crystal Display with an integral LED backlight system. The matrix employs a-Si Thin Film Transistor as the active element. It is a transmissive type display operating in the normally white mode. This TFT-LCD has 14.0 inches diagonally measured active display area with HD resolution(900 vertical by 1600 horizontal pixel array). Each pixel is divided into Red, Green and Blue sub-pixels or dots which are arranged in vertical stripes. Gray scale or the brightness of the sub-pixel color is determined with a 6-bit gray scale signal for each dot, thus, presenting a palette of more than 262,144 colors.

The LP140WD1 has been designed to apply the interface method that enables low power, high speed, low EMI.

The LP140WD1 is intended to support applications where thin thickness, low power are critical factors and graphic displays are important. In combination with the vertical arrangement of the sub-pixels, the LP140WD1 characteristics provide an excellent flat display for office automation products such as Notebook PC.

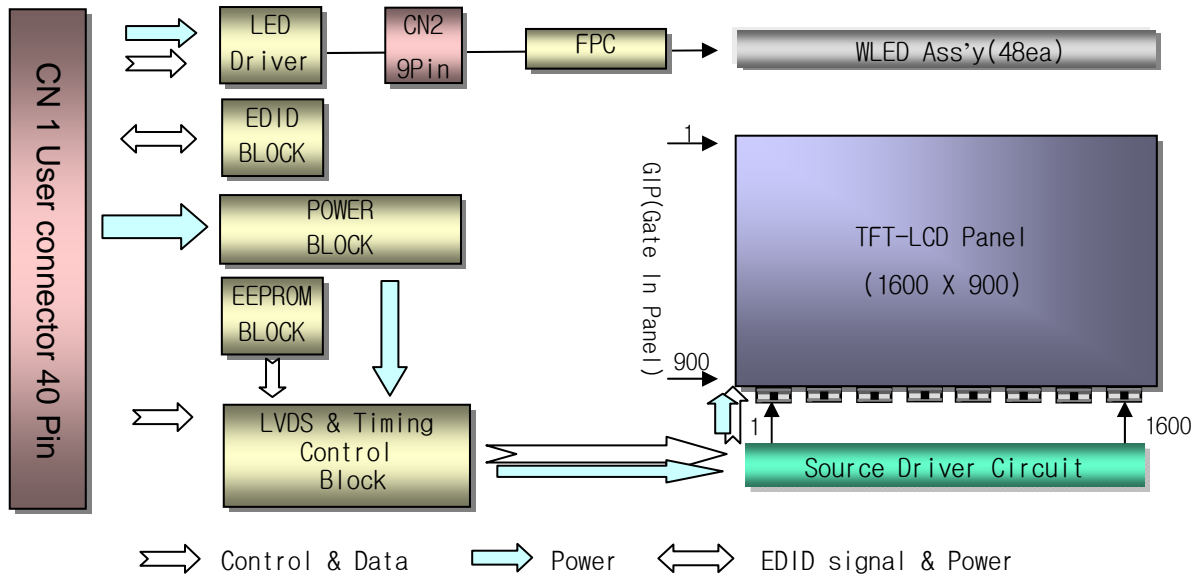

General Features

Active Screen Size	14.0 inches diagonal
Outline Dimension	323.5(H, typ) × 192.0(V, typ) × 5.2(D,max) [mm]
Pixel Pitch	0.1935mm × 0.1935 mm
Pixel Format	1600 horiz. By 900 vert. Pixels RGB strip arrangement
Color Depth	6-bit, 262,144 colors
Luminance, White	200 cd/m ² (Typ.5 point)
Power Consumption	Total 5.0 Watt (Typ.) @ Logic input 1.45 Watt (Typ.), B/L input 3.56 Watt (Typ.)
Weight	375g (Max.)
Display Operating Mode	Transmissive mode, normally white
Surface Treatment	Anti-glare treatment of the front polarizer
RoHS Comply	Yes

2. Absolute Maximum Ratings

The following are maximum values which, if exceeded, may cause faulty operation or damage to the unit.

Table 1. ABSOLUTE MAXIMUM RATINGS

Parameter	Symbol	Values		Units	Notes
		Min	Max		
Power Input Voltage	VCC	-0.3	4.0	Vdc	at 25 ± 5°C
Operating Temperature	TOP	0	50	°C	1
Storage Temperature	HST	-20	60	°C	1
Operating Ambient Humidity	HOP	10	90	%RH	1
Storage Humidity	HST	10	90	%RH	1

Note : 1. Temperature and relative humidity range are shown in the figure below.
Wet bulb temperature should be 39°C Max, and no condensation of water.

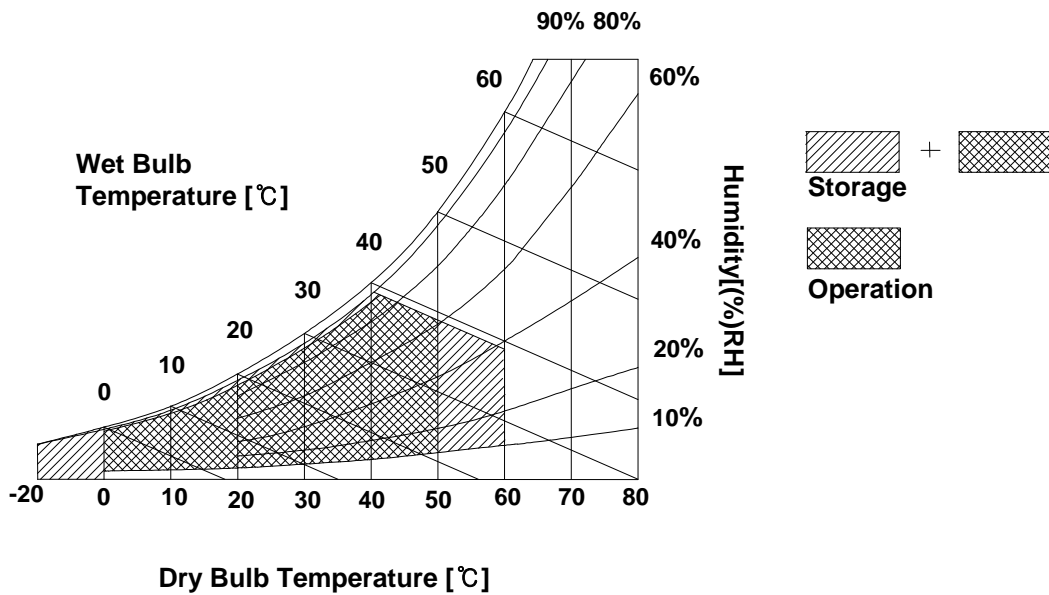

3. Electrical Specifications

3-1. Electrical Characteristics

The LP140WD1 requires two power inputs. The first logic is employed to power the LCD electronics and to drive the TFT array and liquid crystal. The second backlight is the input about LED BL with LED Driver.

Table 2. ELECTRICAL CHARACTERISTICS

Parameter	Symbol	Values			Unit	Notes
		Min	Typ	Max		
LOGIC :						
Power Supply Input Voltage	V _{CC}	3.0	3.3	3.6	V	1
Power Supply Input Current	Mosaic I _{CC}	370	440	510	mA	2
Power Consumption	P _{CC}	-	1.45	1.68	W	2
Power Supply Inrush Current	I _{CC_P}	-	-	2000	mA	3
LVDS Impedance	Z _{LVDS}	90	100	110	Ω	4
BACKLIGHT : (with LED Driver)						
LED Power Input Voltage	V _{LED}	7.0	12.0	20.0	V	5
LED Power Input Current	I _{LED}	-	297	315	mA	6
LED Power Consumption	P _{LED}	-	3.56	3.78	W	6
LED Power Inrush Current	I _{LED_P}	-	-	2000	mA	7
PWM Duty Ratio		6	-	100	%	8
PWM Jitter	-	0	-	0.3	%	9
PWM Impedance	Z _{PWM}	20	40	60	kΩ	
PWM Frequency	F _{PWM}	200	-	1000	Hz	10
PWM High Level Voltage	V _{PWM_H}	3.0	-	5.3	V	
PWM Low Level Voltage	V _{PWM_L}	0	-	0.5	V	
LED_EN Impedance	Z _{PWM}	20	40	60	kΩ	
LED_EN High Voltage	V _{LED_EN_H}	3.0	-	5.3	V	
LED_EN Low Voltage	V _{LED_EN_L}	0	-	0.5	V	
Life Time		12,000	-	-	Hrs	11

Product Specification

Note)

1. The measuring position is the connector of LCM and the test conditions are under 25°C, $f_v = 60\text{Hz}$, Black pattern.
2. The specified I_{cc} current and power consumption are under the $V_{cc} = 3.3\text{V}$, 25°C, $f_v = 60\text{Hz}$ condition whereas Mosaic pattern is displayed and f_v is the frame frequency.

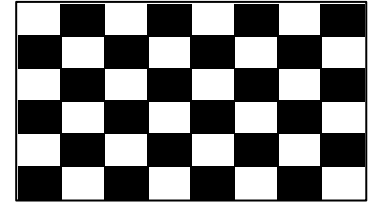

3. The below figures are the measuring V_{cc} condition and the V_{cc} control block LGD used.
The V_{cc} condition is same the minimum of T1 at Power on sequence.

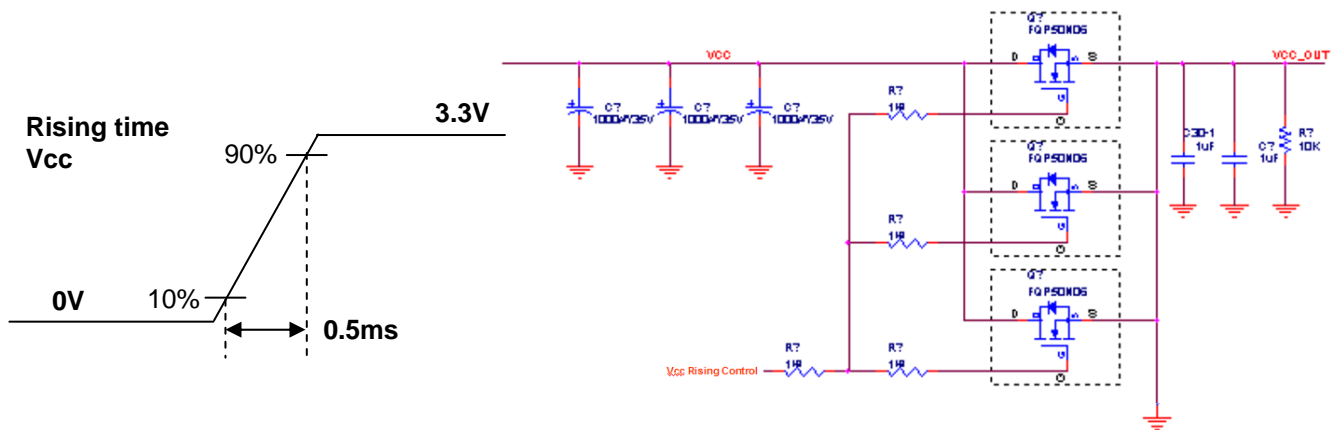

4. This impedance value is needed to proper display and measured form LVDS Tx to the mating connector.
5. The measuring position is the connector of LCM and the test conditions are under 25°C.
6. The current and power consumption with LED Driver are under the $V_{led} = 12.0\text{V}$, 25°C, Dimming of Max luminance whereas White pattern is displayed and f_v is the frame frequency.
7. The below figures are the measuring V_{led} condition and the V_{led} control block LGD used.
 V_{LED} control block is same with V_{cc} control block.

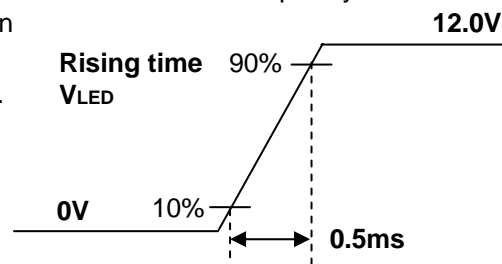

8. The operation of LED Driver below minimum dimming ratio may cause flickering or reliability issue.
9. If Jitter of PWM is bigger than maximum. It may cause flickering.
10. This Spec. is not effective at 100% dimming ratio as an exception because it has DC level equivalent to 0Hz. In spite of acceptable range as defined, the PWM Frequency should be fixed and stable for more consistent brightness control at any specific level desired.
11. The life time is determined as the time at which the typical brightness of LCD is 50% compare to that of initial value at the typical LED current. These LED backlight has 6 strings on it and the typical current of LED's string is base on 20mA.

3-2. Interface Connections

This LCD employs two interface connections, a 40 pin connector is used for the module electronics interface and the other connector is used for the integral backlight system.

The electronics interface connector is a model CABLINE-VS RECE ASS'Y manufactured by I-PEX.

Table 3. MODULE CONNECTOR PIN CONFIGURATION (CN1)

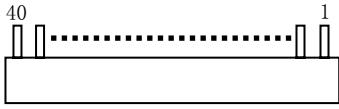
Pin	Symbol	Description	Notes
1	NC	No Connection (Reserved for supplier)	<p>1, Interface chips 1.1 LCD : SW, SW0617 (LCD Controller) including LVDS Receiver 1.2 System : THC63LVDF823A or equivalent * Pin to Pin compatible with LVDS</p> <p>2. Connector 2.1 LCD : CABLINE-VS(20455-040E-XX , I-PEX or its compatibles 2.2 Mating : CABLINE-VS PLUG CABLE ASS'Y or equivalent. 2.3 Connector pin arrangement</p>  <p>[LCD Module Rear View]</p>
2	VCC	Power Supply, 3.3V Typ.	
3	VCC	Power Supply, 3.3V Typ.	
4	V EEDID	DDC 3.3V power	
5	NC	No Connection	
6	Clk EEDID	DDC Clock	
7	DATA EEDID	DDC Data	
8	Odd_R _{IN} 0-	Negative LVDS differential data input	
9	Odd_R _{IN} 0+	Positive LVDS differential data input	
10	GND	Ground	
11	Odd_R _{IN} 1-	Negative LVDS differential data input	
12	Odd_R _{IN} 1+	Positive LVDS differential data input	
13	GND	Ground	
14	Odd_R _{IN} 2-	Negative LVDS differential data input	
15	Odd_R _{IN} 2+	Positive LVDS differential data input	
16	GND	Ground	
17	Odd_CLKIN-	Negative LVDS differential clock input	
18	Odd_CLKIN+	Positive LVDS differential clock input	
19	GND	Ground	
20	Even_R _{IN} 0-	Negative LVDS differential data input	
21	Even_R _{IN} 0+	Positive LVDS differential data input	
19	GND	Ground	
23	Even_R _{IN} 1-	Negative LVDS differential data input	
24	Even_R _{IN} 1+	Positive LVDS differential data input	
19	GND	Ground	
26	Even_R _{IN} 2-	Negative LVDS differential data input	
27	Even_R _{IN} 2+	Positive LVDS differential data input	
19	GND	Ground	
29	Even_CLKIN-	Negative LVDS differential clock input	
30	Even_CLKIN+	Positive LVDS differential clock input	
31	VLED_GND	LED Ground	
32	VLED_GND	LED Ground	
33	VLED_GND	LED Ground	
34	NC	No Connection (Reserved)	
35	PWM	PWM for luminance control	
36	LED_EN	Backlight On/Off Control	
37	NC	No Connection (Reserved)	
38	VLED	LED Power Supply 6V-20V	
39	VLED	LED Power Supply 6V-20V	
40	VLED	LED Power Supply 6V-20V	

3-3. LVDS Signal Timing Specifications

3-3-1. DC Specification

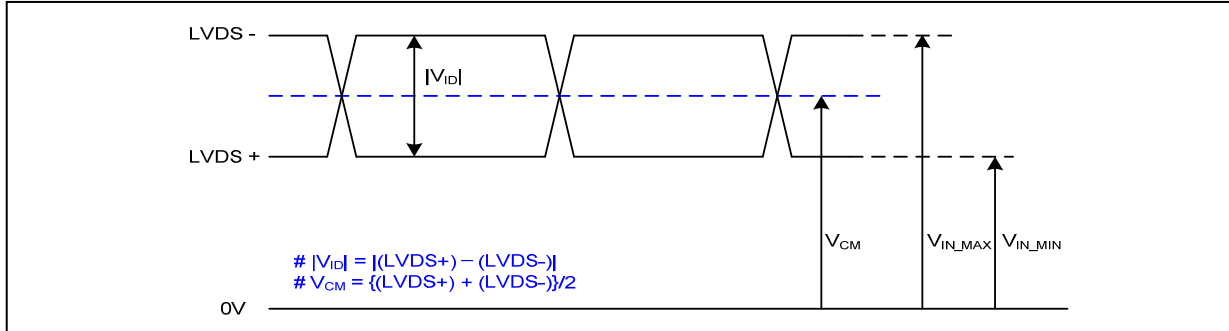

Description	Symbol	Min	Max	Unit	Notes
LVDS Differential Voltage	$ V_{ID} $	100	600	mV	-
LVDS Common mode Voltage	V_{CM}	0.6	1.8	V	-
LVDS Input Voltage Range	V_{IN}	0.3	2.1	V	-

3-3-2. AC Specification

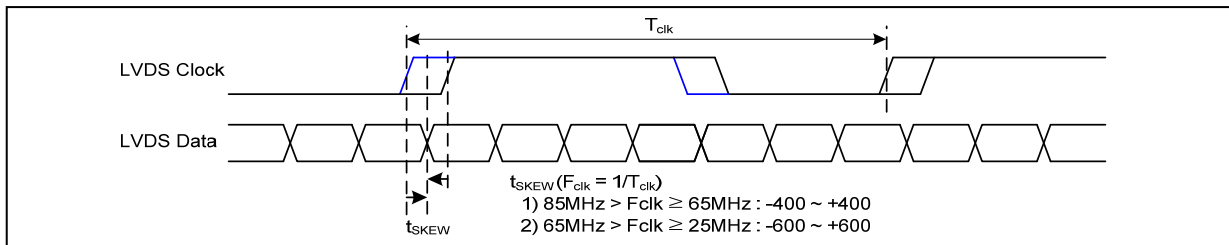

Description	Symbol	Min	Max	Unit	Notes
LVDS Clock to Data Skew Margin	t_{SKEW}	- 400	+ 400	ps	$85MHz > F_{clk} \geq 65MHz$
	t_{SKEW}	- 600	+ 600	ps	$65MHz > F_{clk} \geq 25MHz$
LVDS Clock to Clock Skew Margin (Even to Odd)	t_{SKEW_EO}	- 1/7	+ 1/7	T_{clk}	-
Maximum deviation of input clock frequency during SSC	F_{DEV}	-	± 3	%	-
Maximum modulation frequency of input clock during SSC	F_{MOD}	-	200	KHz	-

Product Specification

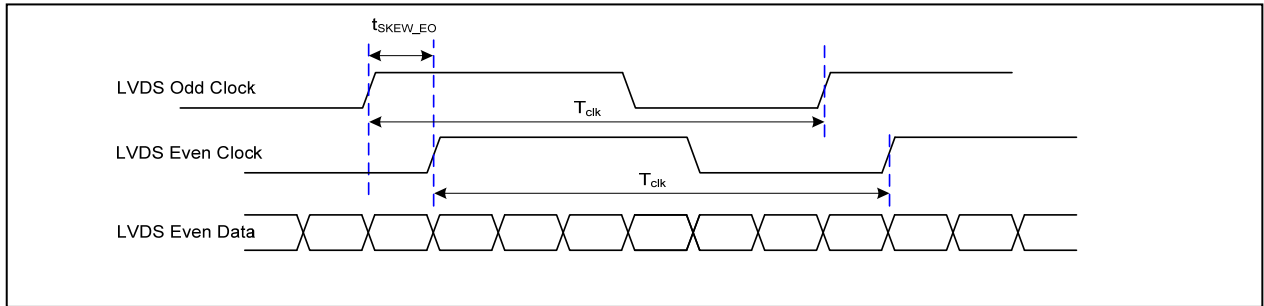

< Clock skew margin between channel >

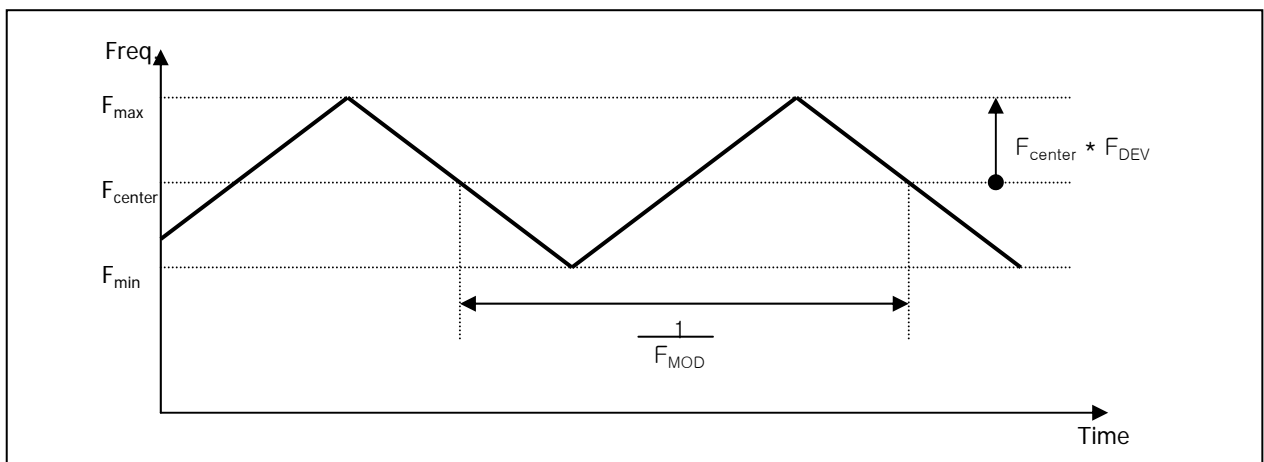

< Spread Spectrum >

3-3-3. Data Format

1) LVDS 2 Port

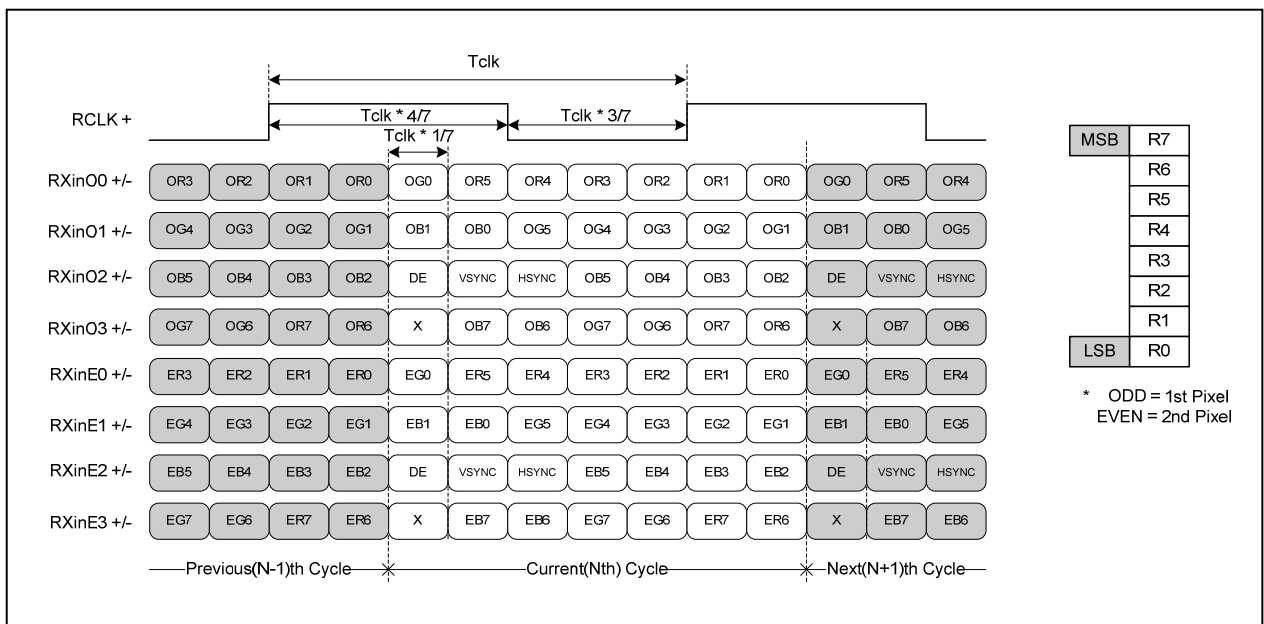

< LVDS Data Format >

3-4. Signal Timing Specifications

This is the signal timing required at the input of the User connector. All of the interface signal timing should be satisfied with the following specifications and specifications of LVDS Tx/Rx for its proper operation.

Table 4. TIMING TABLE

ITEM	Symbol	Min	Typ	Max	Unit	Note
DCLK	Frequency	f_{CLK}	-	53.9	-	MHz
Hsync	Period	t_{HP}	896	960	992	tCLK
	Width	t_{WH}	32	48	56	
	Width-Active	t_{WHA}	800	800	800	
Vsync	Period	t_{VP}	910	936	960	tHP
	Width	t_{WV}	3	5	8	
	Width-Active	t_{WVA}	900	900	900	
Data Enable	Horizontal back porch	t_{HBP}	24	32	40	tCLK
	Horizontal front porch	t_{HFP}	40	80	96	
	Vertical back porch	t_{VBP}	5	28	36	tHP
	Vertical front porch	t_{VFP}	2	3	5	

Note)

- In this documentation, all reliabilities are specified for timing specification based on refresh rate of 60Hz. However, LP140WD1 has a good actual performance even at lower refresh rate(eg. 40Hz or 50Hz) for power saving mode, whereas LP140WD1 is secured only for function under lower refresh rate. 60Hz at Normal mode, 50Hz ,40 Hz at Power save mode. Don't care Flicker level (power save mode).

3-5. Signal Timing Waveforms

Condition : VCC =3.3V

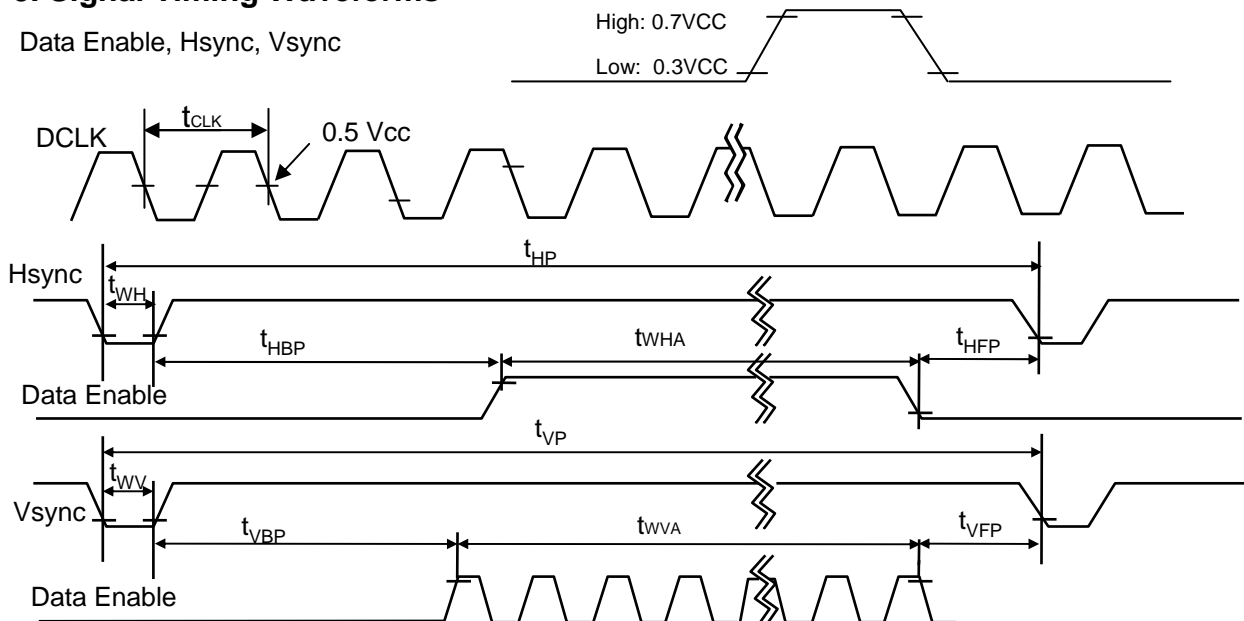

3-6. Color Input Data Reference

The brightness of each primary color (red, green and blue) is based on the 6-bit gray scale data input for the color ; the higher the binary input, the brighter the color. The table below provides a reference for color versus data input.

Table 5. COLOR DATA REFERENCE

Color		Input Color Data																					
		RED						GREEN						BLUE									
		MSB						LSB		MSB						LSB		MSB					
		R5	R4	R3	R2	R1	R0	G5	G4	G3	G2	G1	G0	B5	B4	B3	B2	B1	B0				
Basic Color	Black	0	0	0	0	0	0	0	0	0	0	0	0	0	0	0	0	0	0				
	Red	1	1	1	1	1	1	0	0	0	0	0	0	0	0	0	0	0	0				
	Green	0	0	0	0	0	0	1	1	1	1	1	1	0	0	0	0	0	0				
	Blue	0	0	0	0	0	0	0	0	0	0	0	0	1	1	1	1	1	1				
	Cyan	0	0	0	0	0	0	1	1	1	1	1	1	1	1	1	1	1	1				
	Magenta	1	1	1	1	1	1	0	0	0	0	0	0	1	1	1	1	1	1				
	Yellow	1	1	1	1	1	1	1	1	1	1	1	1	0	0	0	0	0	0				
	White	1	1	1	1	1	1	1	1	1	1	1	1	1	1	1	1	1	1				
RED	RED (00)	0	0	0	0	0	0	0	0	0	0	0	0	0	0	0	0	0	0				
	RED (01)	0	0	0	0	0	1	0	0	0	0	0	0	0	0	0	0	0	0				
									
	RED (62)	1	1	1	1	1	0	0	0	0	0	0	0	0	0	0	0	0	0				
	RED (63)	1	1	1	1	1	1	0	0	0	0	0	0	0	0	0	0	0	0				
GREEN	GREEN (00)	0	0	0	0	0	0	0	0	0	0	0	0	0	0	0	0	0	0				
	GREEN (01)	0	0	0	0	0	0	0	0	0	0	0	1	0	0	0	0	0	0				
									
	GREEN (62)	0	0	0	0	0	0	1	1	1	1	1	0	0	0	0	0	0	0				
	GREEN (63)	0	0	0	0	0	0	1	1	1	1	1	1	0	0	0	0	0	0				
BLUE	BLUE (00)	0	0	0	0	0	0	0	0	0	0	0	0	0	0	0	0	0	0				
	BLUE (01)	0	0	0	0	0	0	0	0	0	0	0	0	0	0	0	0	0	1				
									
	BLUE (62)	0	0	0	0	0	0	0	0	0	0	0	0	1	1	1	1	1	0				
	BLUE (63)	0	0	0	0	0	0	0	0	0	0	0	0	1	1	1	1	1	1				

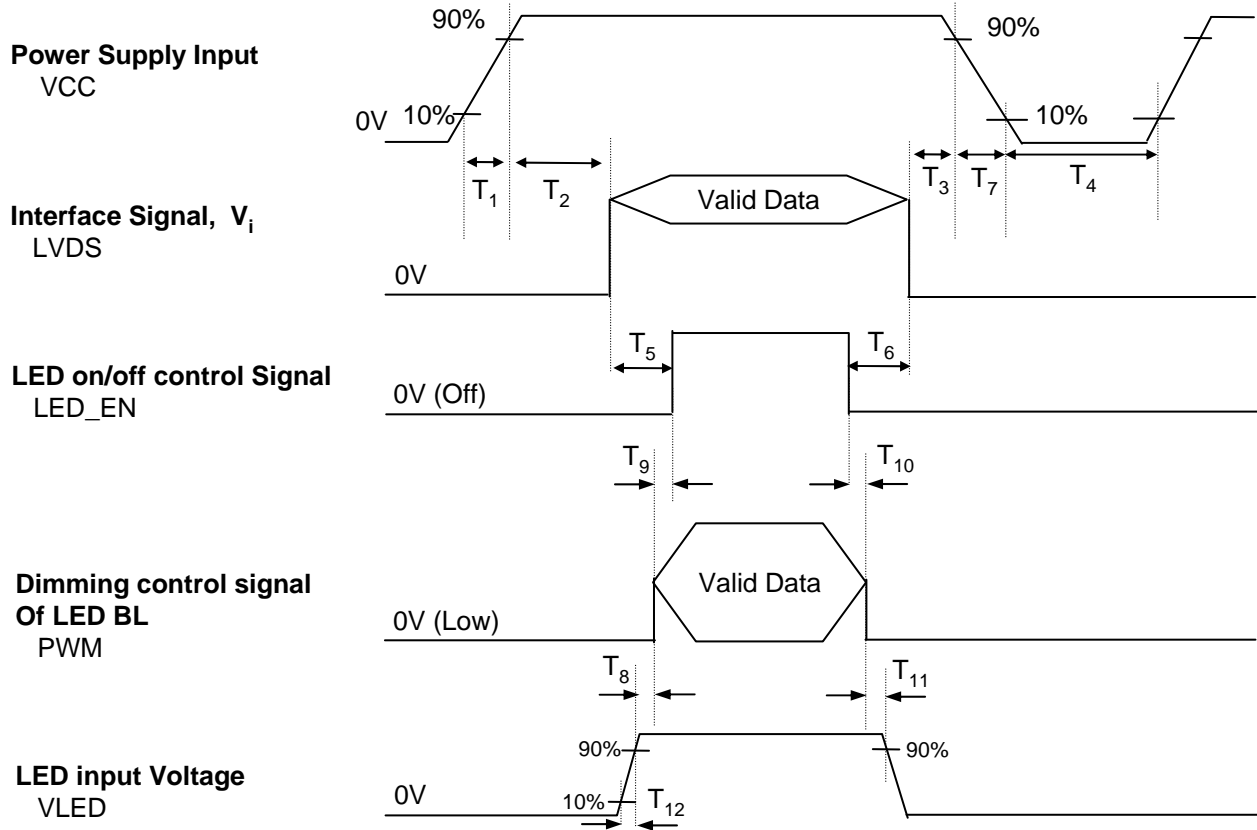
3-7. Power Sequence

Table 6. POWER SEQUENCE TABLE

Logic Parameter	Value			Units	LED Parameter	Value			Units
	Min.	Typ.	Max.			Min.	Typ.	Max.	
T ₁	0.5	-	10	ms	T ₈	10	-	-	ms
T ₂	0	-	50	ms	T ₉	0	-	-	ms
T ₃	0	-	50	ms	T ₁₀	0	-	-	ms
T ₄	400	-	-	ms	T ₁₁	10	-	-	ms
T ₅	200	-	-	ms	T ₁₂	0.5	-	-	ms
T ₆	200	-	-	ms					
T ₇	3	-	10	ms					

Note)

1. Do not insert the mating cable when system turn on.
2. Valid Data have to meet "3-3. LVDS Signal Timing Specifications"
3. LVDS, LED_EN and PWM need to pull-down condition on invalid status.
4. LGD recommend the rising sequence of VLED after the Vcc and valid status of LVDS turn on.

Product Specification

4. Optical Specification

Optical characteristics are determined after the unit has been 'ON' and stable for approximately 30 minutes in a dark environment at 25°C. The values specified are at an approximate distance 50cm from the LCD surface at a viewing angle of Φ and Θ equal to 0°.

FIG. 1 presents additional information concerning the measurement equipment and method.

FIG. 1 Optical Characteristic Measurement Equipment and Method

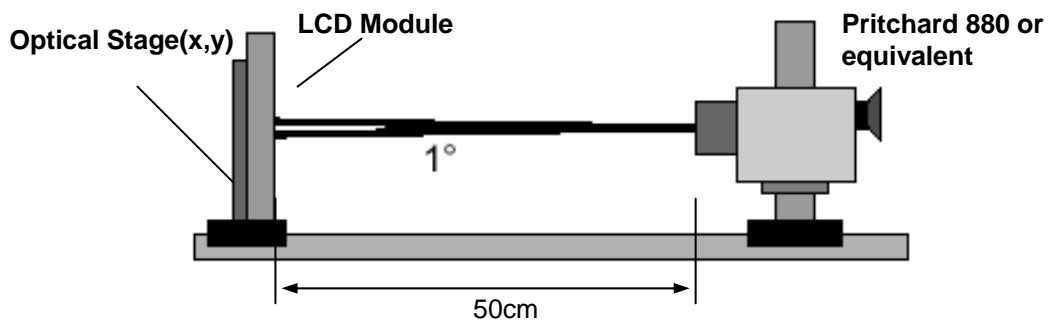

Table 7. OPTICAL CHARACTERISTICS

Ta=25°C, VCC=3.3V, fv=60Hz, fCLK= 53.9MHz, ILED= 20 mA

Parameter	Symbol	Values			Units	Notes
		Min	Typ	Max		
Contrast Ratio	CR	300	-	-		1
Surface Luminance, white	L _{WH}	170	200	-	cd/m ²	2
Luminance Variation	δ_{WHITE}	-	-	1.6		3
Response Time	Tr _R +Tr _D	-	8	16	ms	4
Color Coordinates						
RED	RX	0.574	0.604	0.634		
	RY	0.326	0.356	0.386		
GREEN	GX	0.296	0.326	0.356		
	GY	0.551	0.581	0.611		
BLUE	BX	0.119	0.149	0.179		
	BY	0.023	0.053	0.083		
WHITE	WX	0.283	0.313	0.343		
	WY	0.299	0.329	0.359		
Viewing Angle						
x axis, right($\Phi=0^\circ$)	Θ_r	40	-	-	degree	5
x axis, left ($\Phi=180^\circ$)	Θ_l	40	-	-	degree	
y axis, up ($\Phi=90^\circ$)	Θ_u	10	-	-	degree	
y axis, down ($\Phi=270^\circ$)	Θ_d	30	-	-	degree	
Gray Scale						6

Product Specification

Note)

1. Contrast Ratio(CR) is defined mathematically as

$$\text{Contrast Ratio} = \frac{\text{Surface Luminance with all white pixels}}{\text{Surface Luminance with all black pixels}}$$

2. Surface luminance is the average of 5 point across the LCD surface 50cm from the surface with all pixels displaying white. For more information see FIG 1.

$$L_{WH} = \text{Average}(L_1, L_2, \dots L_5)$$

3. The variation in surface luminance , The panel total variation (δ_{WHITE}) is determined by measuring L_N at each test position 1 through 13 and then defined as followed numerical formula.
For more information see FIG 2.

$$\delta_{WHITE} = \frac{\text{Maximum}(L_1, L_2, \dots L_{13})}{\text{Minimum}(L_1, L_2, \dots L_{13})}$$

4. Response time is the time required for the display to transition from white to black (rise time, Tr_R) and from black to white(Decay Time, Tr_D). For additional information see FIG 3.

5. Viewing angle is the angle at which the contrast ratio is greater than 10. The angles are determined for the horizontal or x axis and the vertical or y axis with respect to the z axis which is normal to the LCD surface. For more information see FIG 4.

6. Gray scale specification

* $f_V = 60\text{Hz}$

Gray Level	Luminance [%] (Typ)
L0	0
L7	5.8
L15	12.7
L23	21.4
L31	33.2
L39	48.3
L47	66.5
L55	87.0
L63	100

FIG. 2 Luminance

<measuring point for surface luminance & measuring point for luminance variation>

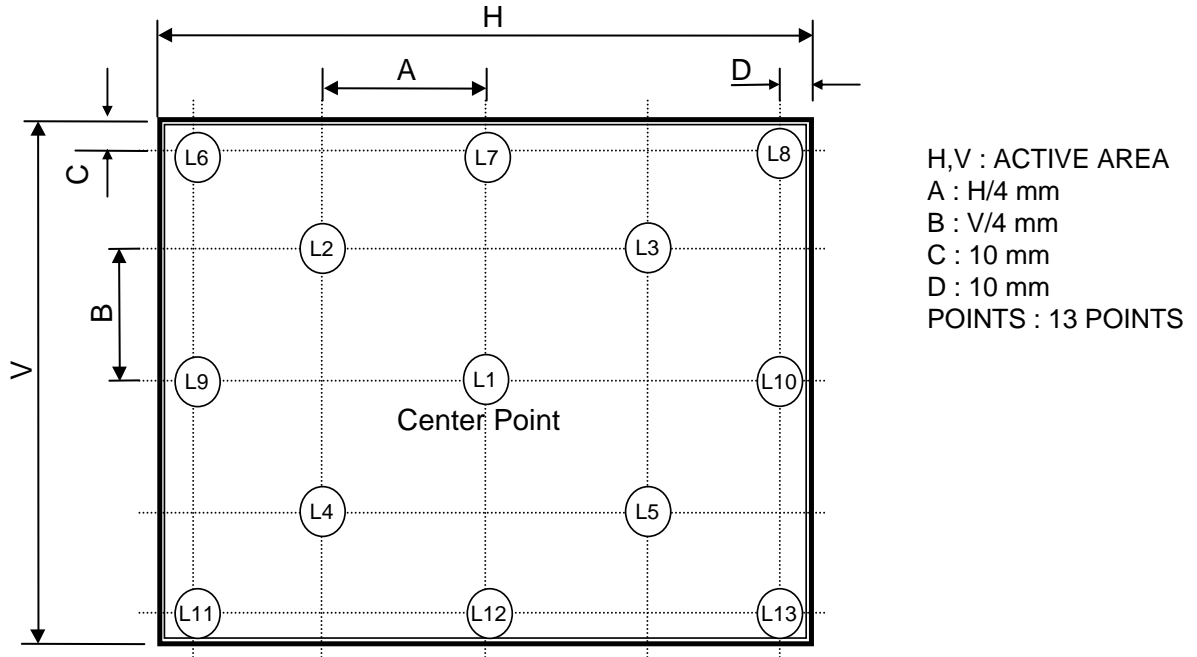
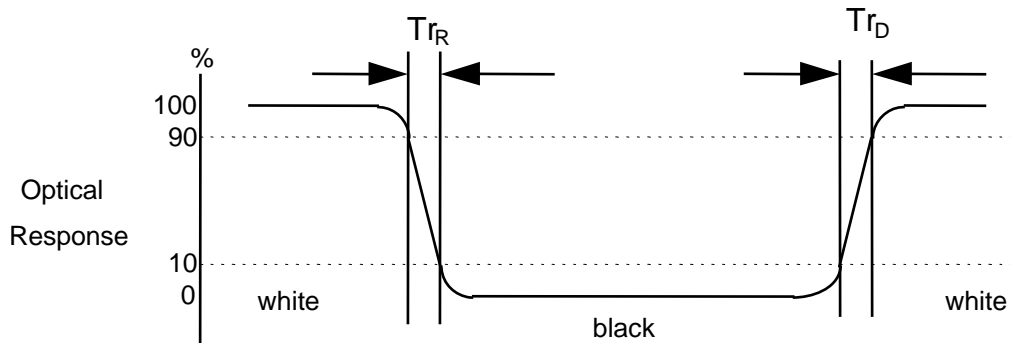

FIG. 3 Response Time

The response time is defined as the following figure and shall be measured by switching the input signal for “black” and “white”.



5. Mechanical Characteristics

The contents provide general mechanical characteristics for the model LP140WD1. In addition the figures in the next page are detailed mechanical drawing of the LCD.

Outline Dimension	Horizontal	323.5 ± 0.5mm
	Vertical	192.0 ± 0.5mm
	Thickness	5.2mm (max)
Bezel Area	Horizontal (VESA Standard)	316.0 ± 0.5mm
	Vertical (VESA Standard)	177.4 ± 0.5mm
Active Display Area	Horizontal	309.60 mm
	Vertical	174.15 mm
Weight	375g (Max.)	
Surface Treatment	Anti-glare treatment of the front polarizer	

Product Specification

<FRONT VIEW>

Note) Unit:[mm], General tolerance: $\pm 0.5\text{mm}$

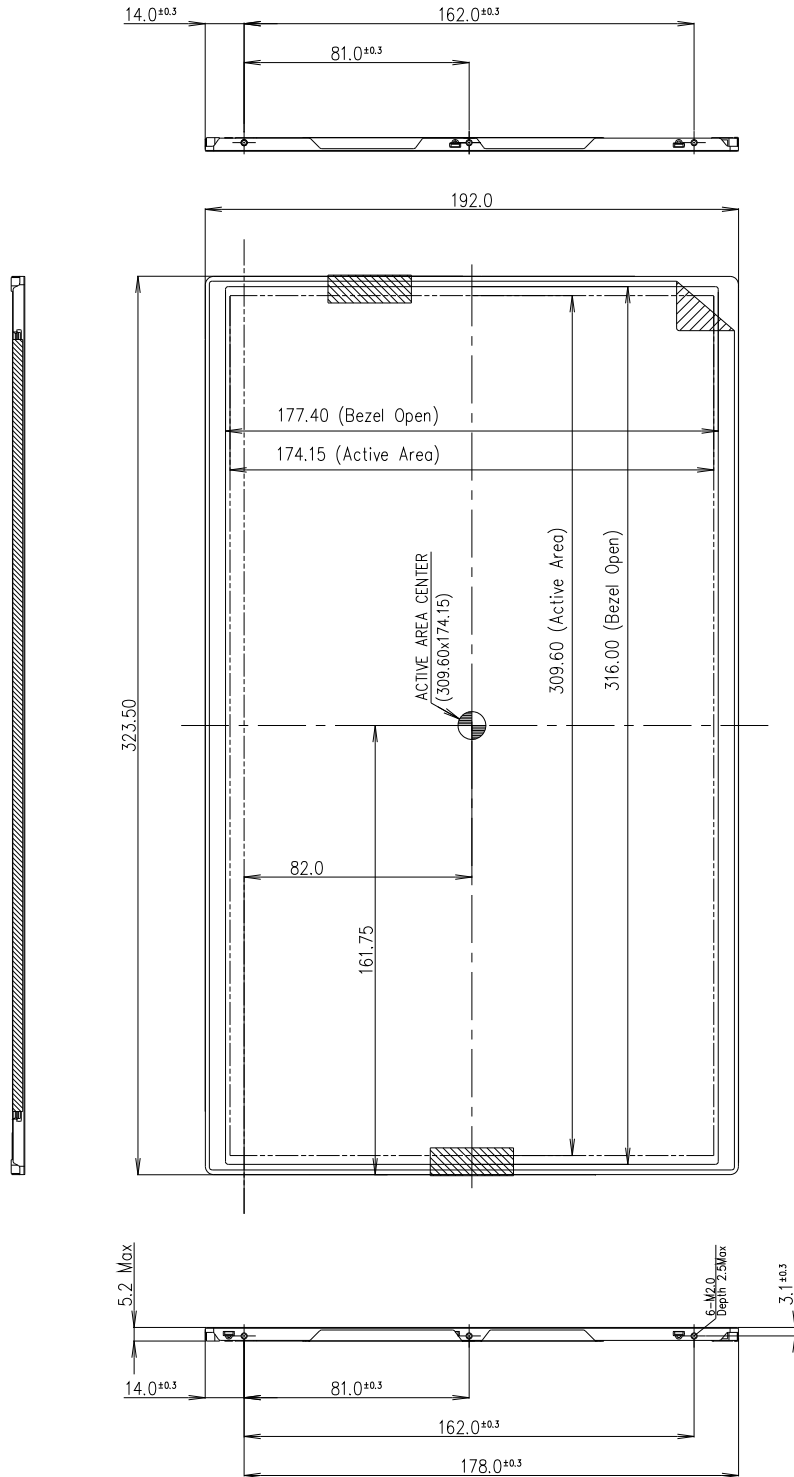

Product Specification

<REAR VIEW>

Note) Unit:[mm], General tolerance: ± 0.5mm

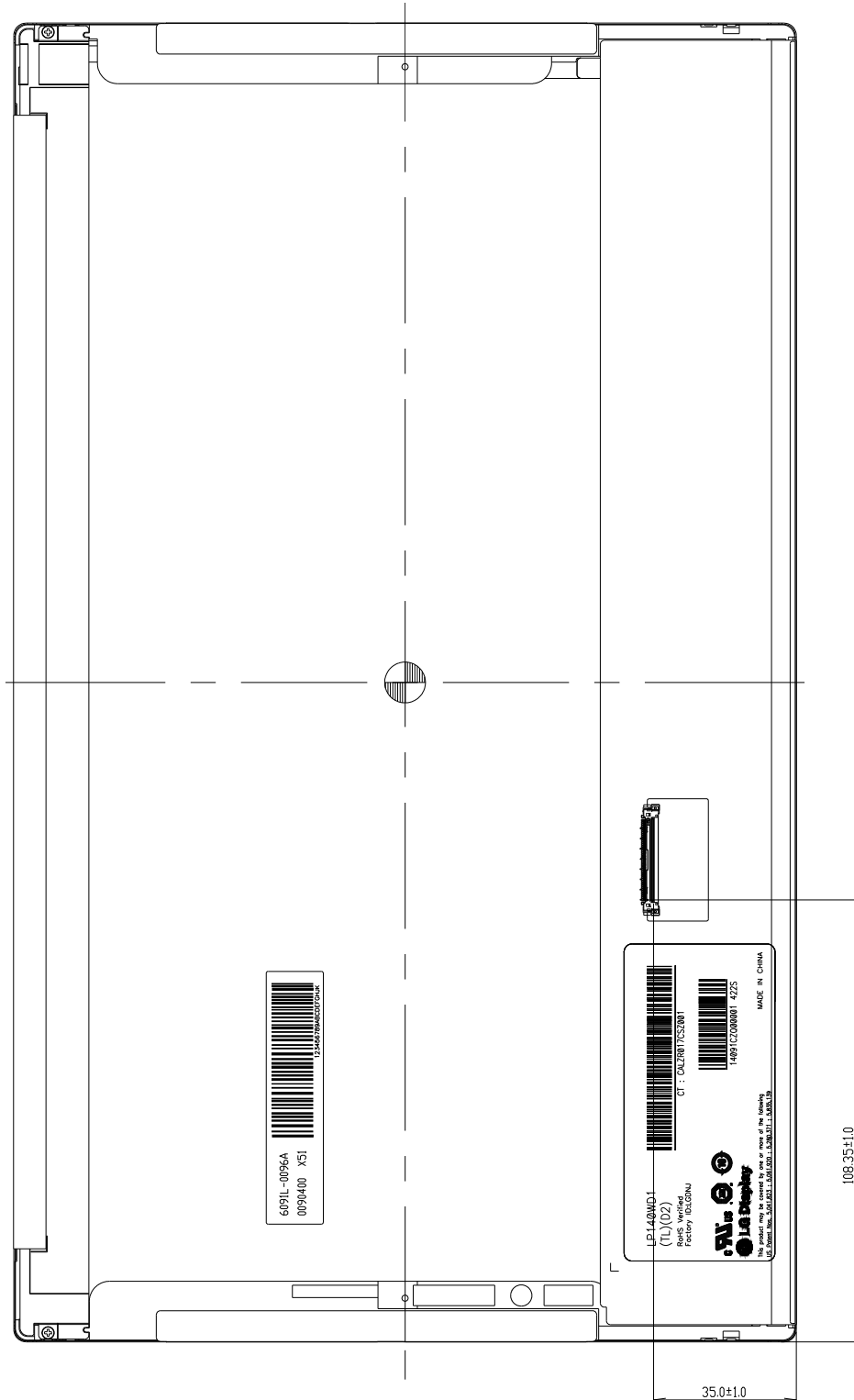

Product Specification

[DETAIL DESCRIPTION OF SIDE MOUNTING SCREW]

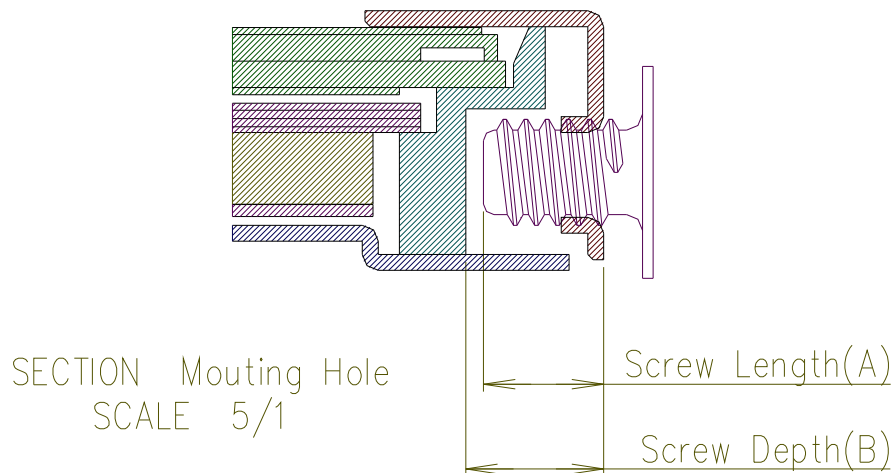

- * Mounting Screw Length (A)
= 2.0(Min) / 2.5(Max)
- * Mounting Screw Hole Depth (B)
= 2.5(Min)
- * Mounting hole location : 3.1(typ.)
- * Torque : 2.0 kgf.cm(Max)
(Measurement gauge : torque meter)

Notes : 1. Screw plated through the method of non-electrolytic nickel plating is preferred to reduce possibility that results in vertical and/or horizontal line defect due to the conductive particles from screw surface.

LGD Proposal for system cover design.(Appendix)

1	Gap check for securing the enough gap between LCM and System cover.	
<p>The diagram illustrates the assembly of the LCM (Liquid Crystal Module) and the system cover. On the left, a top-down view of the LCM reflector side is shown with various colored components. To the right, a cross-sectional view shows the LCM being inserted into a housing. A horizontal double-headed arrow at the top indicates the 'Max Thickness' of the LCM. A vertical dashed line marks 'A Boundary Line'. Three pink arrows point from the system cover towards the LCM, indicating potential contact or pressure. A blue rectangular block labeled 'Sponge' is positioned between the system cover and the LCM. The 'System Cover' is shown as a white outline on the right.</p>		
Define	<p>1.Rear side of LCM is sensitive against external stress,and previous check about interference is highly needed.</p> <p>2.In case there is something from system cover comes into the boundary above,mechanical interference may cause the FOS defects. (Eg:Ripple,White spot..)</p>	
2	Check if antenna cable is sufficiently apart from T-CON of LCD Module.	
Define	<p>Two diagrams illustrate the correct placement of the antenna cable relative to the T-CON (Timing Controller) on the LCD module. The left diagram, labeled 'NO GOOD', shows the antenna cable (red and orange lines) overlapping with the T-CON (black square). The right diagram, labeled 'GOOD', shows the antenna cable routed away from the T-CON, ensuring no overlap. Labels 'Antenna' and 'Antenna Cable' are present in both diagrams.</p>	
1.If system antenna is overlapped with T-CON,it might be cause the noise.		

LGD Proposal for system cover design.

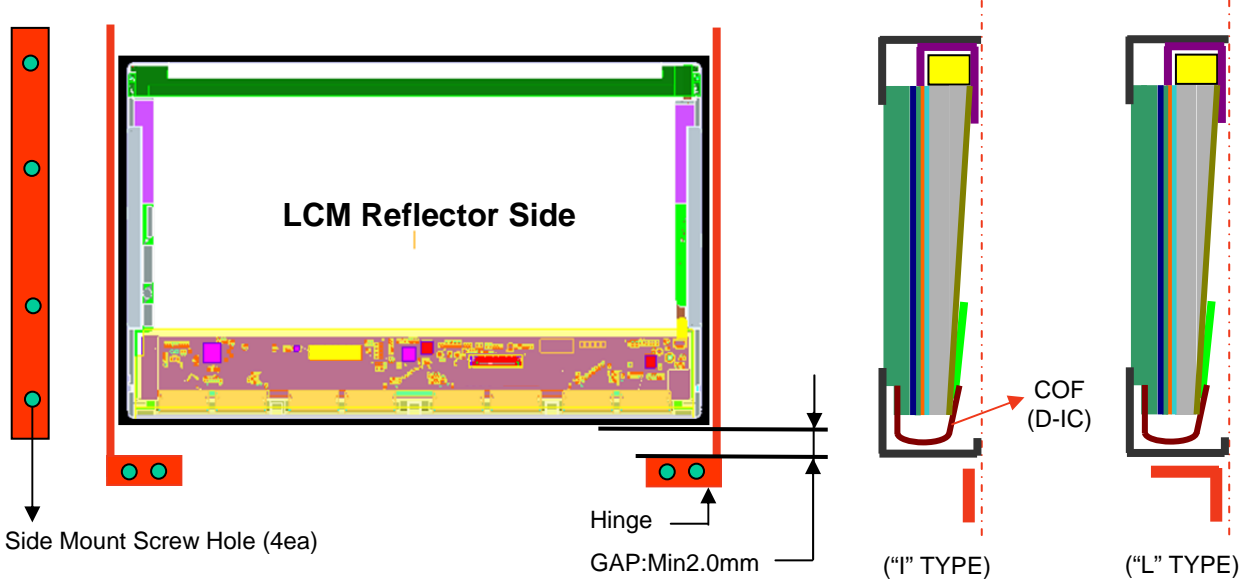
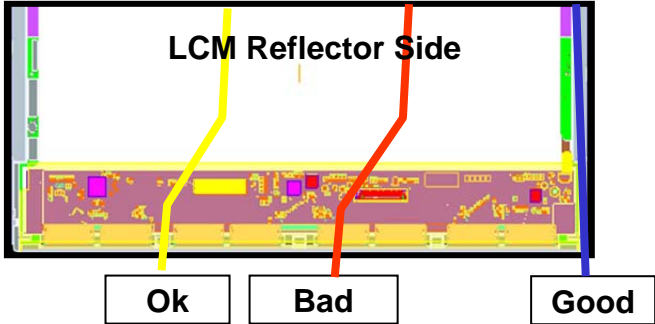
3	Gap check for securing the enough gap between LCM and System hinge.	
 <p>LCM Reflector Side</p> <p>Side Mount Screw Hole (4ea)</p> <p>Hinge</p> <p>GAP: Min2.0mm</p> <p>COF (D-IC)</p> <p>("I" TYPE)</p> <p>("L" TYPE)</p>		
Define	<p>1. At least 2.0mm of gap needs to be secured to prevent the shock related defects.</p> <p>2. "L" type of hinge is recommended than "I" type under shock test.</p>	
4	Checking the path of the System wire.	
 <p>LCM Reflector Side</p> <p>Ok</p> <p>Bad</p> <p>Good</p>		
Define	<p>1. COF area needs to be handled with care.</p> <p>2. GOOD → Wire path design to system side. OK → Wire path is located between COFs. BAD → Wire path overlapped with COF area.</p>	

LGD Proposal for system cover design.

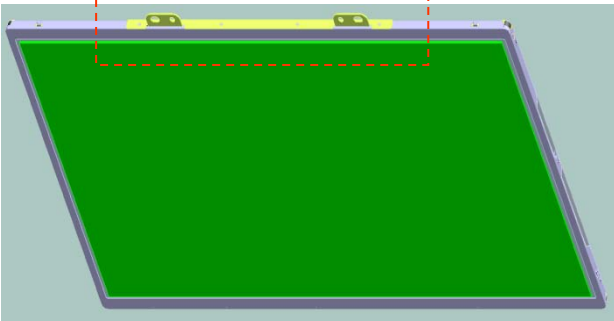
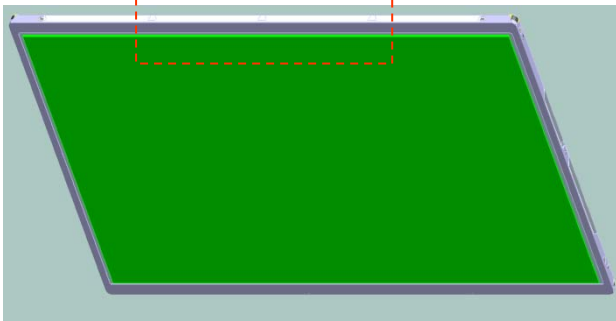
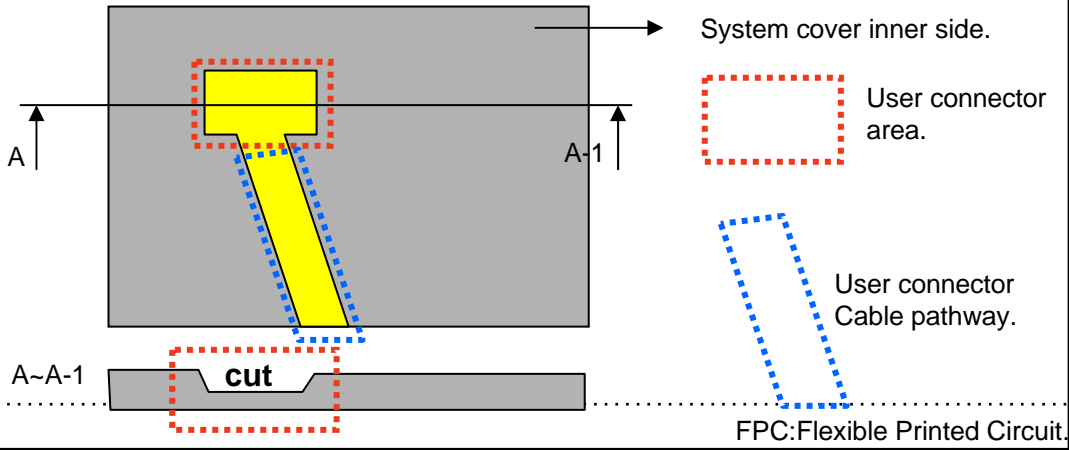
5	Using a bracket on the top of LCM is not recommended.	
<div style="display: flex; justify-content: space-around; align-items: center;"> <div style="text-align: center;">  <p>bracket</p> </div> </div> <div style="display: flex; justify-content: space-around; align-items: center; margin-top: 20px;"> <div style="text-align: center;">  <p>With bracket</p> </div> <div style="text-align: center;">  <p>Without bracket</p> </div> </div>		
Define	<p>1.Condition without bracket is good for mechanical noise,and can minimize the light leakage from deformation of bracket.</p> <p>2.The results shows that there is no difference between the condition with or without bracket.</p>	
6	Securing additional gap on CNT area..	
		
Define	<p>1.CNT area is specially sensitive against external stress,and additional gap by cutting on system cover will be helpful on removing the Ripple.</p> <p>2.Using a thinner CNT will be better. (eg: FPC type)</p>	

6. Reliability

Environment test condition

No.	Test Item	Conditions
1	High temperature storage test	Ta= 60°C, 240h
2	Low temperature storage test	Ta= -20°C, 240h
3	High temperature operation test	Ta= 50°C, 50%RH, 240h
4	Low temperature operation test	Ta= 0°C, 240h
5	Vibration test (non-operating)	Sine wave, 10 ~ 500 ~ 10Hz, 1.5G, 0.37oct/min 3 axis, 1hour/axis
6	Shock test (non-operating)	Half sine wave, 180G, 2ms one shock of each six faces(I.e. run 180G 2ms for all six faces)
7	Altitude operating storage / shipment	0 ~ 10,000 feet (3,048m) 24Hr 0 ~ 40,000 feet (12,192m) 24Hr

{ Result Evaluation Criteria }

There should be no change which might affect the practical display function when the display quality test is conducted under normal operating condition.

7. International Standards

7-1. Safety

- a) UL 60950-1, Second Edition, Underwriters Laboratories Inc.
Information Technology Equipment - Safety - Part 1 : General Requirements.
- b) CAN/CSA C22.2 No.60950-1-07, Second Edition, Canadian Standards Association.
Information Technology Equipment - Safety - Part 1 : General Requirements.
- c) EN 60950-1:2006 + A11:2009, European Committee for Electrotechnical Standardization (CENELEC).
Information Technology Equipment - Safety - Part 1 : General Requirements.
- d) IEC 60950-1:2005, Second Edition, The International Electrotechnical Commission (IEC).
Information Technology Equipment - Safety - Part 1 : General Requirements.

7-2. EMC

- a) ANSI C63.4 "American National Standard for Methods of Measurement of Radio-Noise Emissions from Low-Voltage Electrical and Electronic Equipment in the Range of 9 kHz to 40 GHz." American National Standards Institute (ANSI), 2003.
- b) CISPR 22 "Information technology equipment – Radio disturbance characteristics – Limit and methods of measurement." International Special Committee on Radio Interference (CISPR), 2005.
- c) CISPR 13 "Sound and television broadcast receivers and associated equipment – Radio disturbance characteristics – Limits and method of measurement." International Special Committee on Radio Interference (CISPR), 2006.

7-3. Environment

- a) RoHS, Directive 2002/95/EC of the European Parliament and of the council of 27 January 2003

8. Packing

8-1. Designation of Lot Mark

a) Lot Mark

A	B	C	D	E	F	G	H	I	J	K	L	M
---	---	---	---	---	---	---	---	---	---	---	---	---

A,B,C : SIZE(INCH)
 E : MONTH

D : YEAR
 F ~ M : SERIAL NO.

Note

1. YEAR

Year	2001	2002	2003	2004	2005	2006	2007	2008	2009	2010
Mark	1	2	3	4	5	6	7	8	9	0

2. MONTH

Month	Jan	Feb	Mar	Apr	May	Jun	Jul	Aug	Sep	Oct	Nov	Dec
Mark	1	2	3	4	5	6	7	8	9	A	B	C

b) Location of Lot Mark

Serial No. is printed on the label. The label is attached to the backside of the LCD module.
 This is subject to change without prior notice.

8-2. Packing Form

a) Package quantity in one box : 30 pcs

b) Box Size : 490mm X 390mm X 256 mm

9. PRECAUTIONS

Please pay attention to the followings when you use this TFT LCD module.

9-1. MOUNTING PRECAUTIONS

- (1) You must mount a module using holes arranged in four corners or four sides.
- (2) You should consider the mounting structure so that uneven force (ex. Twisted stress) is not applied to the module. And the case on which a module is mounted should have sufficient strength so that external force is not transmitted directly to the module.
- (3) Please attach the surface transparent protective plate to the surface in order to protect the polarizer. Transparent protective plate should have sufficient strength in order to resist external force.
- (4) You should adopt radiation structure to satisfy the temperature specification.
- (5) Acetic acid type and chlorine type materials for the cover case are not desirable because the former generates corrosive gas of attacking the polarizer at high temperature and the latter causes circuit break by electro-chemical reaction.
- (6) Do not touch, push or rub the exposed polarizers with glass, tweezers or anything harder than HB pencil lead. And please do not rub with dust clothes with chemical treatment. Do not touch the surface of polarizer for bare hand or greasy cloth. (Some cosmetics are detrimental to the polarizer.)
- (7) When the surface becomes dusty, please wipe gently with absorbent cotton or other soft materials like chamois soaks with petroleum benzene. Normal-hexane is recommended for cleaning the adhesives used to attach front / rear polarizers. Do not use acetone, toluene and alcohol because they cause chemical damage to the polarizer.
- (8) Wipe off saliva or water drops as soon as possible. Their long time contact with polarizer causes deformations and color fading.
- (9) Do not open the case because inside circuits do not have sufficient strength.

9-2. OPERATING PRECAUTIONS

- (1) The spike noise causes the mis-operation of circuits. It should be lower than following voltage :
 $V = \pm 200\text{mV}$ (Over and under shoot voltage)
- (2) Response time depends on the temperature. (In lower temperature, it becomes longer.)
- (3) Brightness depends on the temperature. (In lower temperature, it becomes lower.)
And in lower temperature, response time (required time that brightness is stable after turned on) becomes longer.
- (4) Be careful for condensation at sudden temperature change. Condensation makes damage to polarizer or electrical contacted parts. And after fading condensation, smear or spot will occur.
- (5) When fixed patterns are displayed for a long time, remnant image is likely to occur.
- (6) Module has high frequency circuits. Sufficient suppression to the electromagnetic interference shall be done by system manufacturers. Grounding and shielding methods may be important to minimize the interference.

9-3. ELECTROSTATIC DISCHARGE CONTROL

Since a module is composed of electronic circuits, it is not strong to electrostatic discharge. Make certain that treatment persons are connected to ground through wrist band etc. And don't touch interface pin directly.

9-4. PRECAUTIONS FOR STRONG LIGHT EXPOSURE

Strong light exposure causes degradation of polarizer and color filter.

9-5. STORAGE

When storing modules as spares for a long time, the following precautions are necessary.

- (1) Store them in a dark place. Do not expose the module to sunlight or fluorescent light. Keep the temperature between 5°C and 35°C at normal humidity.
- (2) The polarizer surface should not come in contact with any other object.
It is recommended that they be stored in the container in which they were shipped.

9-6. HANDLING PRECAUTIONS FOR PROTECTION FILM

- (1) When the protection film is peeled off, static electricity is generated between the film and polarizer.
This should be peeled off slowly and carefully by people who are electrically grounded and with well ion-blown equipment or in such a condition, etc.
- (2) The protection film is attached to the polarizer with a small amount of glue. If some stress is applied to rub the protection film against the polarizer during the time you peel off the film, the glue is apt to remain on the polarizer.
Please carefully peel off the protection film without rubbing it against the polarizer.
- (3) When the module with protection film attached is stored for a long time, sometimes there remains a very small amount of glue still on the polarizer after the protection film is peeled off.
- (4) You can remove the glue easily. When the glue remains on the polarizer surface or its vestige is recognized, please wipe them off with absorbent cotton waste or other soft material like chamois soaked with normal-hexane.

Product Specification

APPENDIX A. Enhanced Extended Display Identification Data (EEDID™) 1/3

	Byte (Dec)	Byte (Hex)	Field Name and Comments	Value (Hex)	Value (Bin)
Header	0	00	Header	00	00000000
	1	01	Header	FF	11111111
	2	02	Header	FF	11111111
	3	03	Header	FF	11111111
	4	04	Header	FF	11111111
	5	05	Header	FF	11111111
	6	06	Header	FF	11111111
	7	07	Header	00	00000000
Vendor / Product EDID Version	8	08	EISA manufacture code (3 Character ID) LGD	30	00110000
	9	09	EISA manufacture code (Compressed ASC II)	E4	11100100
	10	0A	Panel Supplier Reserved - Product Code	54	01010100
	11	0B	(Hex. LSB first)	02	00000010
	12	0C	LCD Module Serial No - Preferred but Optional ("0" if not used)	00	00000000
	13	0D	LCD Module Serial No - Preferred but Optional ("0" if not used)	00	00000000
	14	0E	LCD Module Serial No - Preferred but Optional ("0" if not used)	00	00000000
	15	0F	LCD Module Serial No - Preferred but Optional ("0" if not used)	00	00000000
	16	10	Week of Manufacture 00 weeks	00	00000000
	17	11	Year of Manufacture 2009 years	13	00010011
Display Parameters	18	12	EDID structure version # = 1	01	00000001
	19	13	EDID revision # = 3	03	00000011
	20	14	Video input Definition = Digital signal	80	10000000
	21	15	Max H image size (Rounded cm) = 31 cm	1F	00011111
	22	16	Max V image size (Rounded cm) = 17 cm	11	00010001
	23	17	Display gamma = (gamma*100)-100 = Example:(2.2*100)-100=120 = 2.2 Gamma	78	01111000
	24	18	Feature Support (no_DPMS, no_Active Off/Very Low Power, RGB color display, Timing BLK 1,no_GTF)	0A	00001010
	Panel Color Coordinates	25	19	Red/Green Low Bits (RxRy/GxGy)	05
26		1A	Blue/White Low Bits (BxBy/WxWy)	85	10000101
27		1B	Red X Rx = 0.605	9B	10011011
28		1C	Red Y Ry = 0.355	5B	01011011
29		1D	Green X Gx = 0.329	54	01010100
30		1E	Green Y Gy = 0.579	94	10010100
31		1F	Blue X Bx = 0.150	26	00100110
32		20	Blue Y By = 0.055	0E	00001110
33		21	White X Wx = 0.313	50	01010000
34		22	White Y Wy = 0.329	54	01010100
Established Timings	35	23	Established timing 1 (00h if not used)	00	00000000
	36	24	Established timing 2 (00h if not used)	00	00000000
	37	25	Manufacturer's timings (00h if not used)	00	00000000
Standard Timing ID	38	26	Standard timing ID1 (01h if not used)	01	00000001
	39	27	Standard timing ID1 (01h if not used)	01	00000001
	40	28	Standard timing ID2 (01h if not used)	01	00000001
	41	29	Standard timing ID2 (01h if not used)	01	00000001
	42	2A	Standard timing ID3 (01h if not used)	01	00000001
	43	2B	Standard timing ID3 (01h if not used)	01	00000001
	44	2C	Standard timing ID4 (01h if not used)	01	00000001
	45	2D	Standard timing ID4 (01h if not used)	01	00000001
	46	2E	Standard timing ID5 (01h if not used)	01	00000001
	47	2F	Standard timing ID5 (01h if not used)	01	00000001
	48	30	Standard timing ID6 (01h if not used)	01	00000001
	49	31	Standard timing ID6 (01h if not used)	01	00000001
	50	32	Standard timing ID7 (01h if not used)	01	00000001
	51	33	Standard timing ID7 (01h if not used)	01	00000001
	52	34	Standard timing ID8 (01h if not used)	01	00000001
	53	35	Standard timing ID8 (01h if not used)	01	00000001

Product Specification

APPENDIX A. Enhanced Extended Display Identification Data (EEDID™) 2/3

	Byte (Dec)	Byte (Hex)	Field Name and Comments	Value (Hex)	Value (Bin)
Timing Descriptor #1	54	36	Pixel Clock/10,000 (LSB) 107.8 MHz @ 60Hz	1C	00011100
	55	37	Pixel Clock/10,000 (MSB)	2A	00101010
	56	38	Horizontal Active (lower 8 bits) 1600 Pixels	40	01000000
	57	39	Horizontal Blanking(Thp-HA) (lower 8 bits) 320 Pixels	40	01000000
	58	3A	Horizontal Active / Horizontal Blanking(Thp-HA) (upper 4.4bits)	61	01100001
	59	3B	Vertical Active 900 Lines	84	10000100
	60	3C	Vertical Blanking (Tvp-HA) (DE Blanking typ.for DE only panels) 36 Lines	24	00100100
	61	3D	Vertical Active : Vertical Blanking (Tvp-HA) (upper 4.4bits)	30	00110000
	62	3E	Horizontal Sync. Offset (Thfp) 48 Pixels	30	00110000
	63	3F	Horizontal Sync Pulse Width (HSPW) 32 Pixels	20	00100000
	64	40	Vertical Sync Offset(Tvfp) : Sync Width (VSPW) 3 Lines : 5 Lines	35	00110101
	65	41	Horizontal Vertical Sync Offset/Width (upper 2bits)	00	00000000
	66	42	Horizontal Image Size (mm) 310 mm	36	00110110
	67	43	Vertical Image Size (mm) 174 mm	AE	10101110
68	44	Horizontal Image Size / Vertical Image Size	10	00010000	
69	45	Horizontal Border = 0 (Zero for Notebook LCD)	00	00000000	
70	46	Vertical Border = 0 (Zero for Notebook LCD)	00	00000000	
71	47	Non-Interlace, Normal display, no stereo, Digital Separate (Vsync_NEG, Hsync_POS), DE only note : LSB is set to '1' if panel is DE-timing only. H/V can be ignored.	1B	00011011	
Timing Descriptor #2	72	48	Flag	00	00000000
	73	49	Flag	00	00000000
	74	4A	Flag	00	00000000
	75	4B	Data Type Tag (Descriptor Defined by manufacturer)	00	00000000
	76	4C	Flag	00	00000000
	77	4D	Descriptor Defined by manufacturer	00	00000000
	78	4E	Descriptor Defined by manufacturer	00	00000000
	79	4F	Descriptor Defined by manufacturer	00	00000000
	80	50	Descriptor Defined by manufacturer	00	00000000
	81	51	Descriptor Defined by manufacturer	00	00000000
	82	52	Descriptor Defined by manufacturer	00	00000000
	83	53	Descriptor Defined by manufacturer	00	00000000
	84	54	Descriptor Defined by manufacturer	00	00000000
85	55	Descriptor Defined by manufacturer	00	00000000	
86	56	Descriptor Defined by manufacturer	00	00000000	
87	57	Descriptor Defined by manufacturer	00	00000000	
88	58	Descriptor Defined by manufacturer	00	00000000	
89	59	Descriptor Defined by manufacturer	00	00000000	
Timing Descriptor #3	90	5A	Flag	00	00000000
	91	5B	Flag	00	00000000
	92	5C	Flag	00	00000000
	93	5D	Data Type Tag (ASCII String)	FE	11111110
	94	5E	Flag	00	00000000
	95	5F	ASCII String L	4C	01001100
	96	60	ASCII String G	47	01000111
	97	61	ASCII String	20	00100000
	98	62	ASCII String D	44	01000100
	99	63	ASCII String i	69	01101001
	100	64	ASCII String s	73	01110011
	101	65	ASCII String p	70	01110000
	102	66	ASCII String 1	6C	01101100
	103	67	ASCII String a	61	01100001
104	68	ASCII String y	79	01111001	
105	69	Manufacturer P/N(If<13 char--> 0Ah, then terminate with ASC II code 0Ah,set remaining char = 20h)	0A	00001010	
106	6A	Manufacturer P/N(If<13 char--> 0Ah, then terminate with ASC II code 0Ah,set remaining char = 20h)	20	00100000	
107	6B	Manufacturer P/N(If<13 char--> 0Ah, then terminate with ASC II code 0Ah,set remaining char = 20h)	20	00100000	

APPENDIX A. Enhanced Extended Display Identification Data (EEDID™) 3/3

	Byte (Dec)	Byte (Hex)	Field Name and Comments	Value (Hex)	Value (Bin)
Timing Descriptor #4	108	6C	Flag	00	00000000
	109	6D	Flag	00	00000000
	110	6E	Flag	00	00000000
	111	6F	Data Type Tag (ASCII String)	FE	11111110
	112	70	Flag	00	00000000
	113	71	ASCII String	L	01001100
	114	72	ASCII String	P	01010000
	115	73	ASCII String	1	00110001
	116	74	ASCII String	4	00110100
	117	75	ASCII String	0	00110000
	118	76	ASCII String	W	01010111
	119	77	ASCII String	D	01000100
	120	78	ASCII String	1	00110001
	121	79	ASCII String	-	00101101
	122	7A	ASCII String	T	01010100
123	7B	ASCII String	L	01001100	
124	7C	ASCII String	D	01000100	
125	7D	ASCII String	2	00110010	
Checksum	126	7E	Extension flag (# of optional 128 panel ID extension block to follow, Typ = 0)	00	00000000
	127	7F	Check Sum (The 1-byte sum of all 128 bytes in this panel ID block shall = 0)	61	01100001