

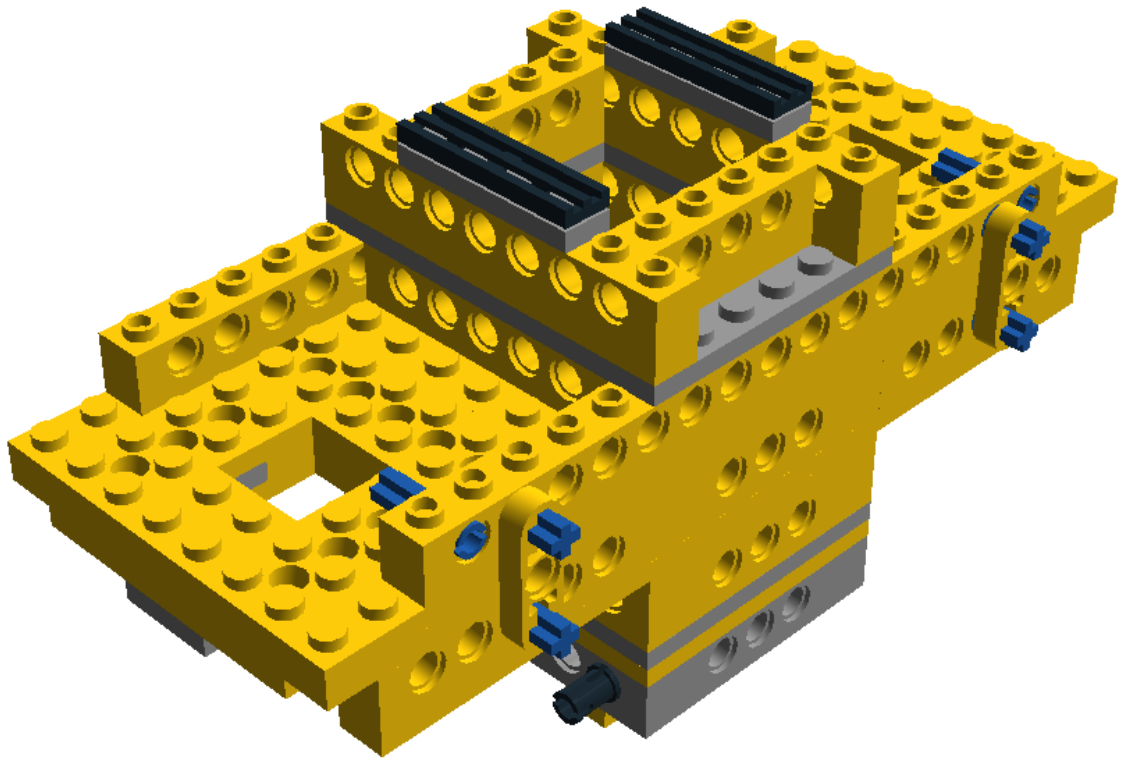

Model Name:

Number of Bricks: 121



Step 1 of 41

1 x



1 x



1 x

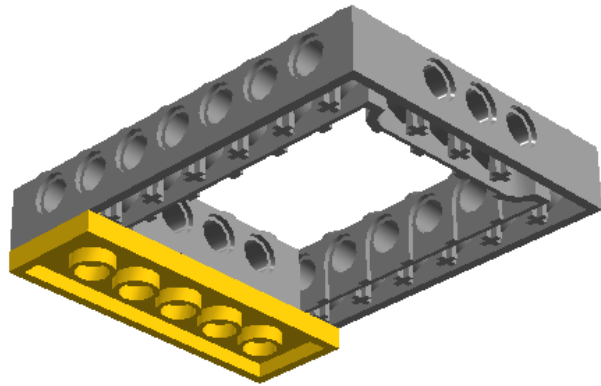

Step 2 of 41

1 x



1 x



2 x

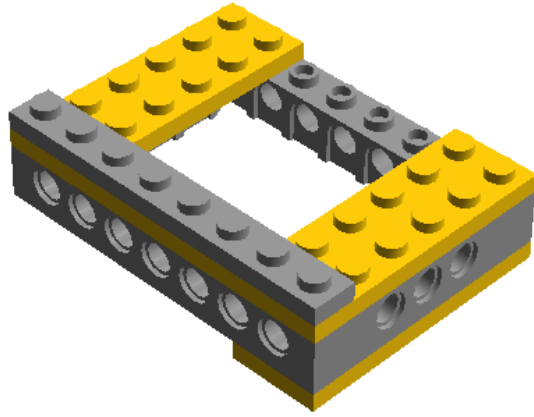

Step 3 of 41

1 x



2 x



1 x

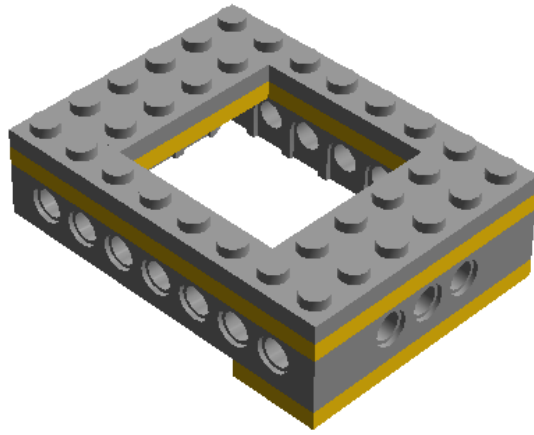

Step 4 of 41

1 x



1 x



1 x

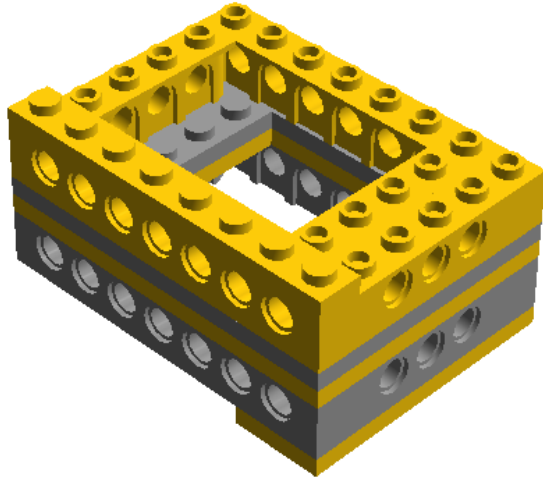

Step 5 of 41

1 x



1 x



1 x



1 x

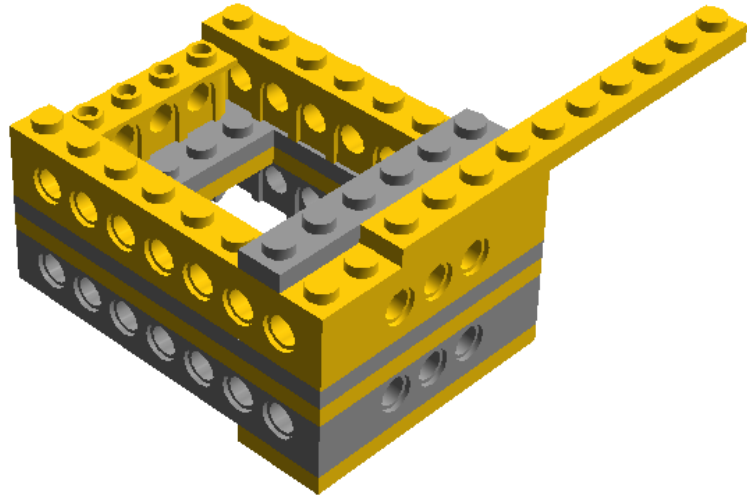

Step 6 of 41

1 x



1 x



1 x



1 x

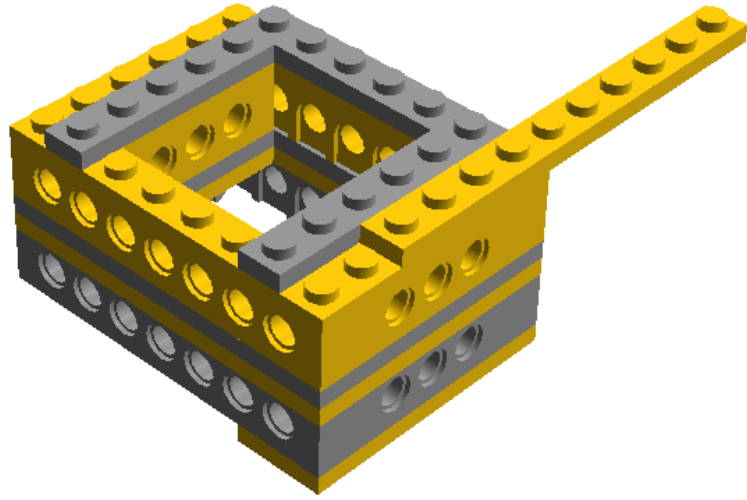

Step 7 of 41

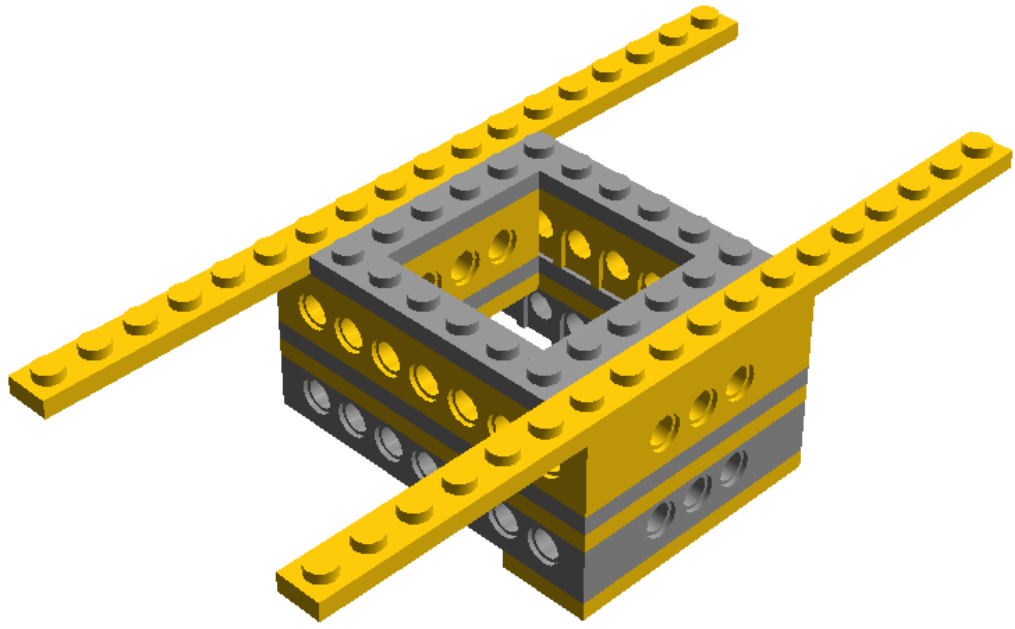
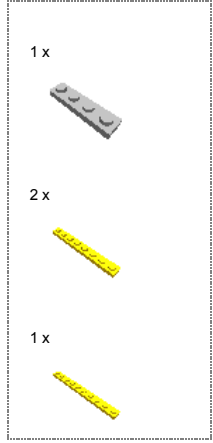



Step 8 of 41

2 x



1 x



1 x

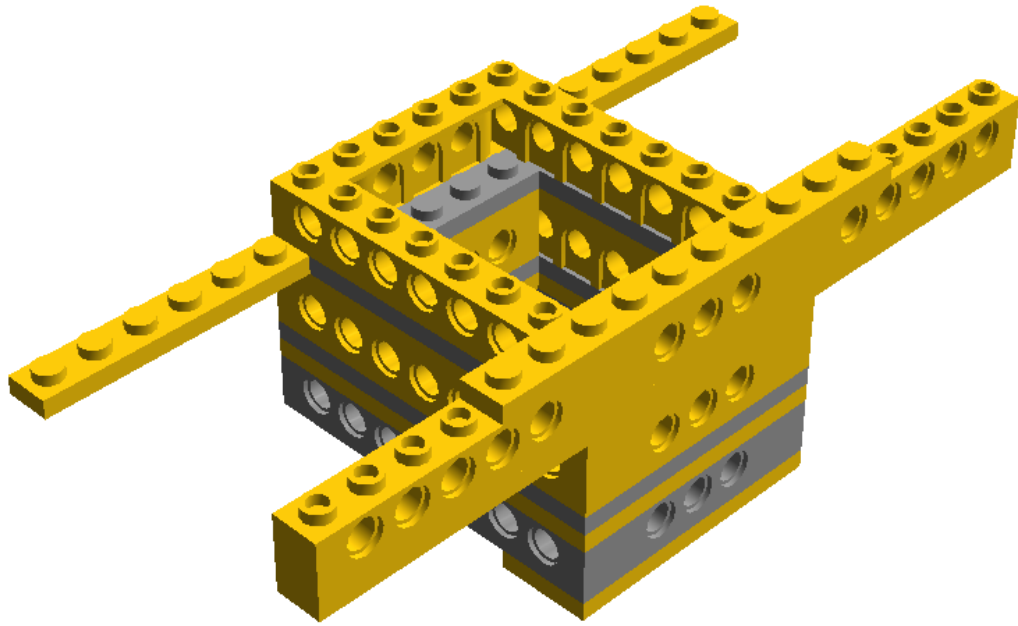

Step 9 of 41

2 x



1 x



1 x

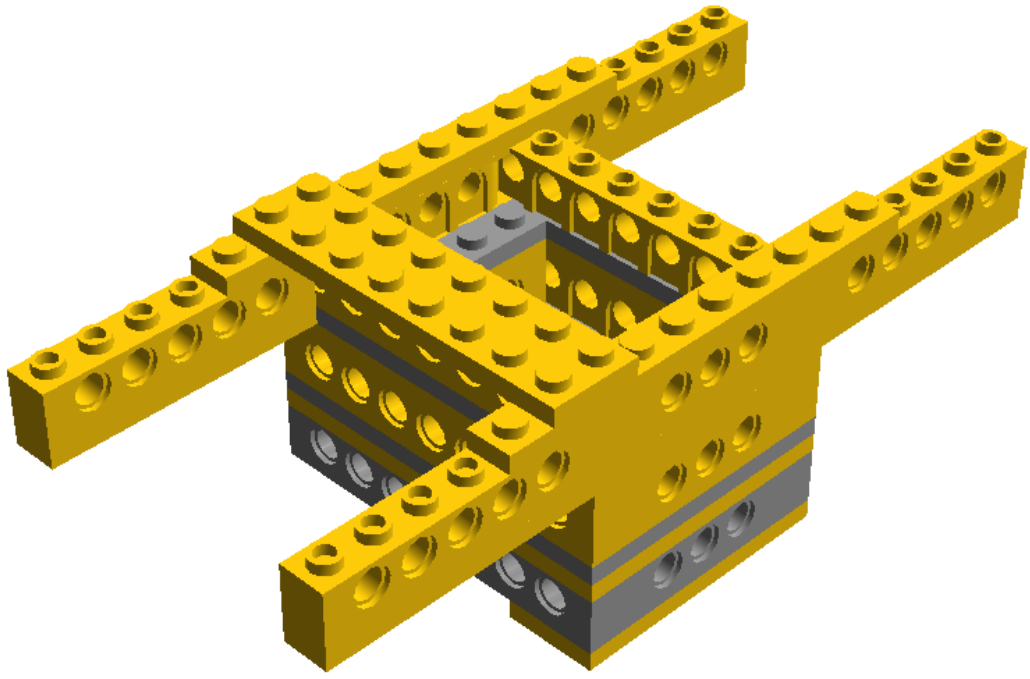

Step 10 of 41

1 x



1 x



1 x



1 x

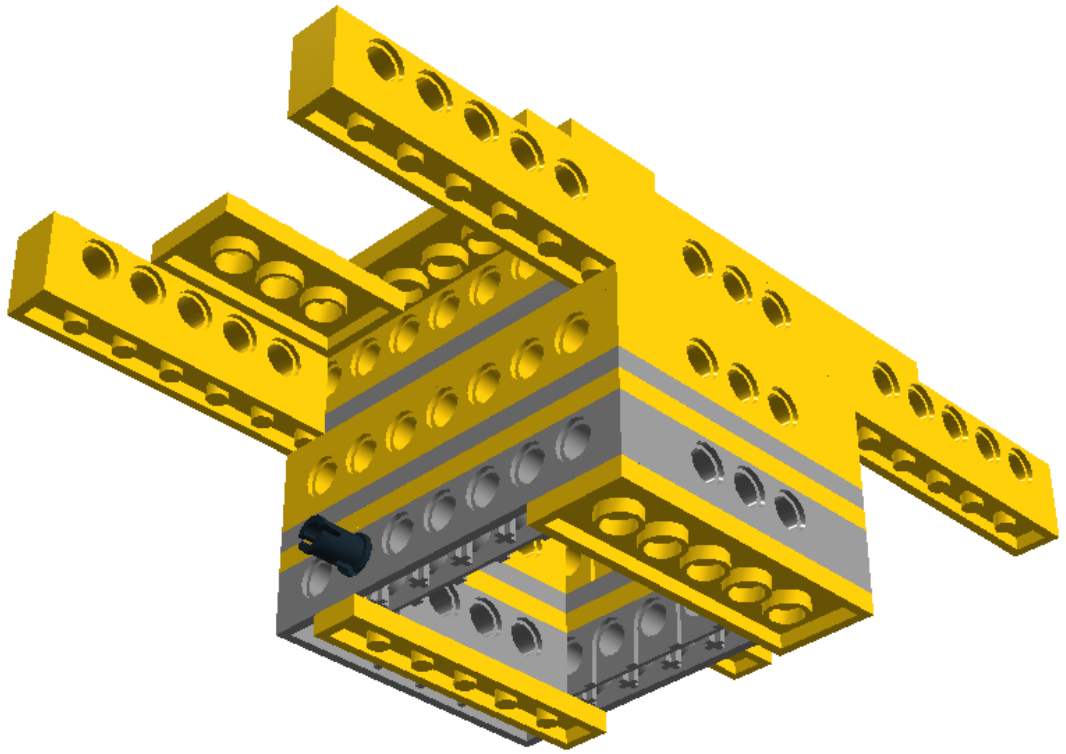

Step 11 of 41

1 x



1 x



1 x



1 x

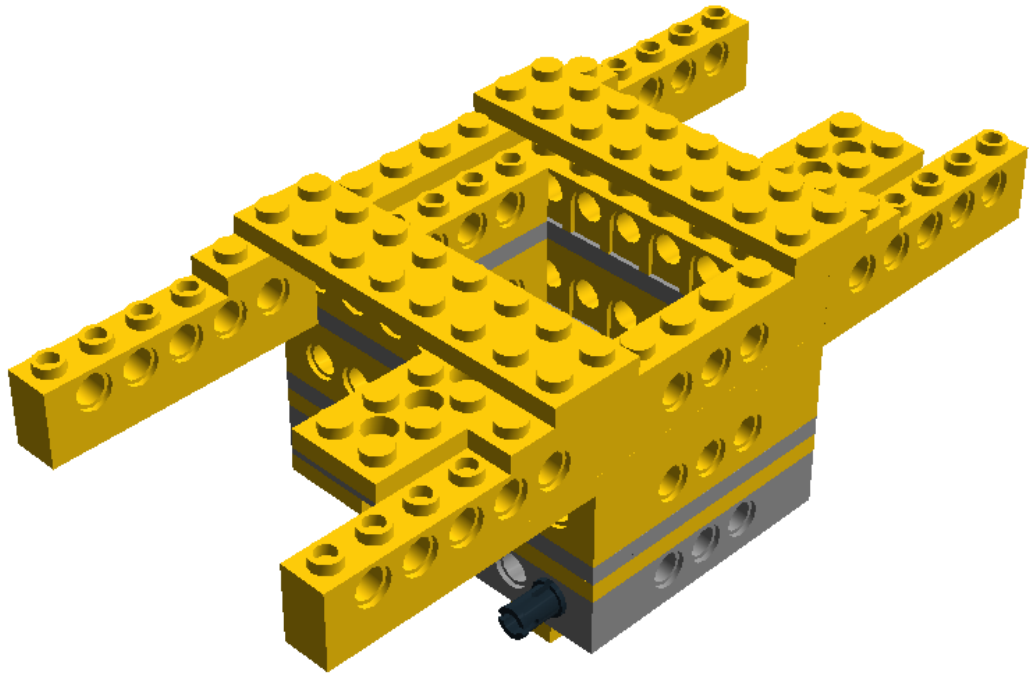

Step 12 of 41

1 x

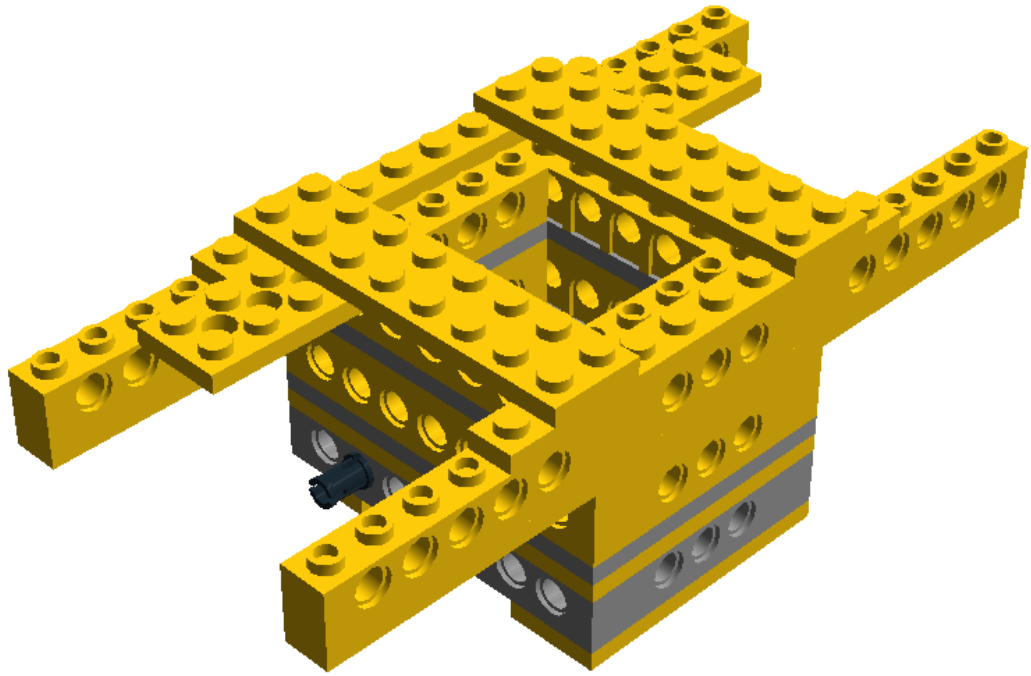

Step 13 of 41

2 x



1 x

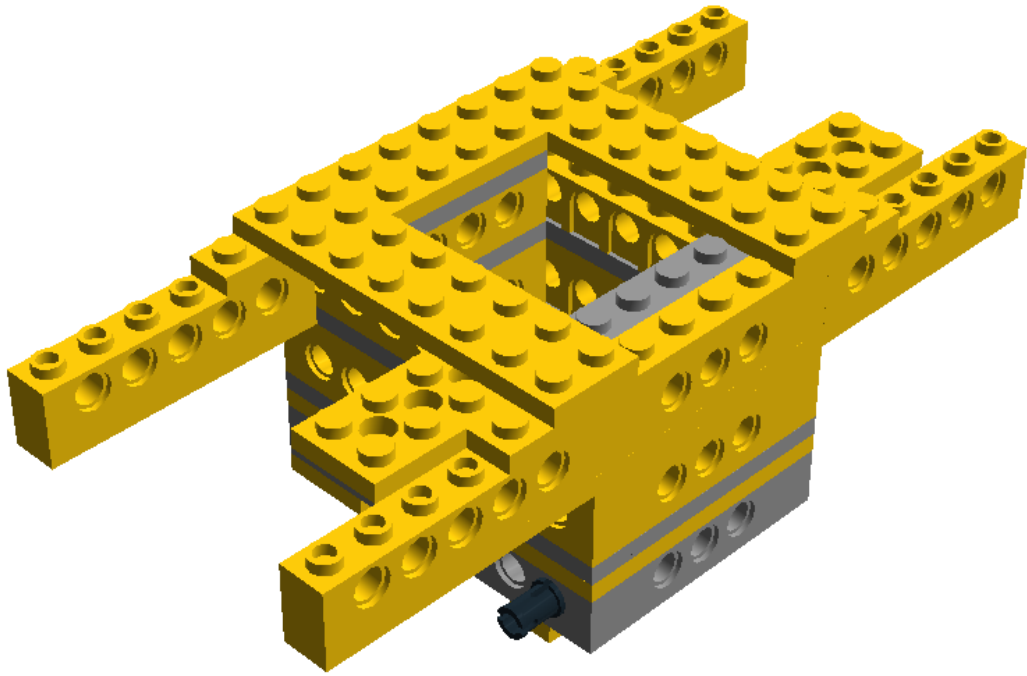

Step 14 of 41

1 x



1 x



1 x



1 x

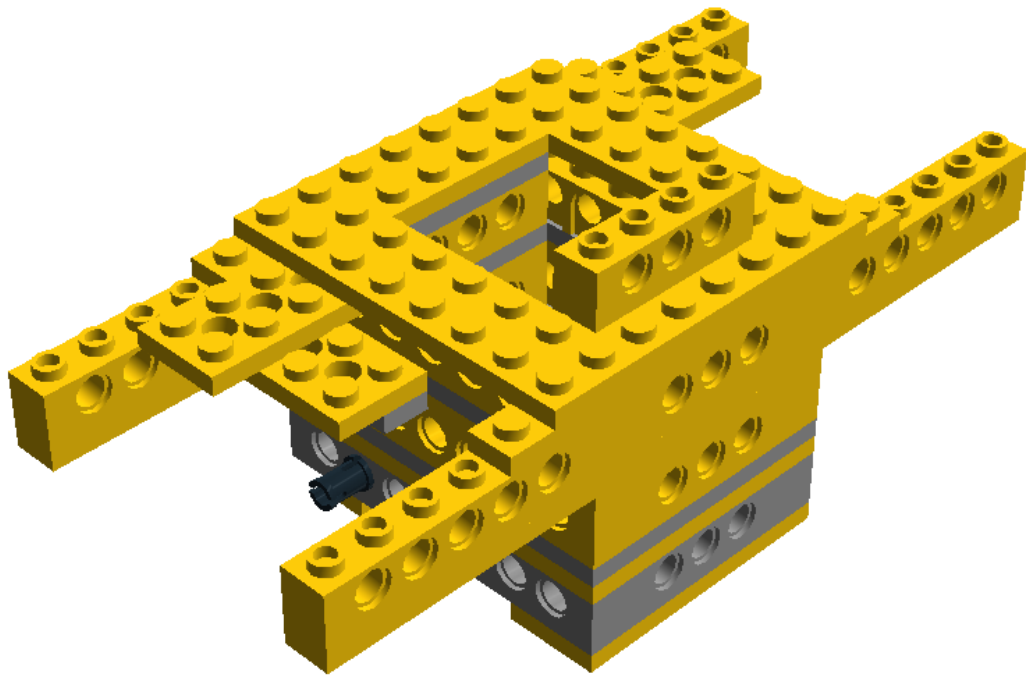

Step 15 of 41

2 x



1 x



1 x

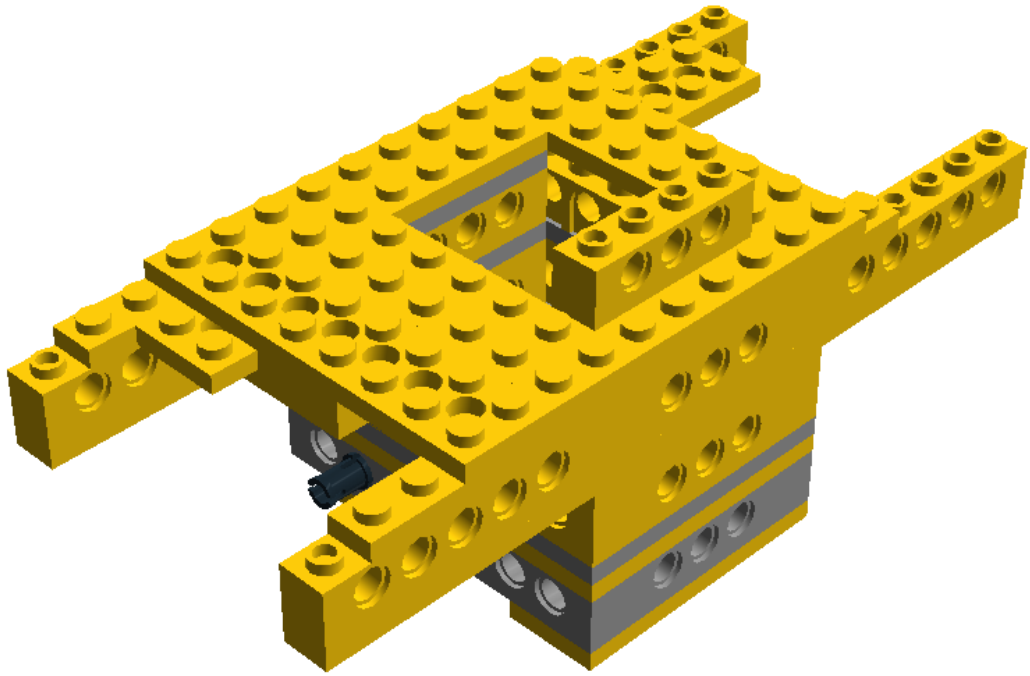



Step 16 of 41

2 x





1 x

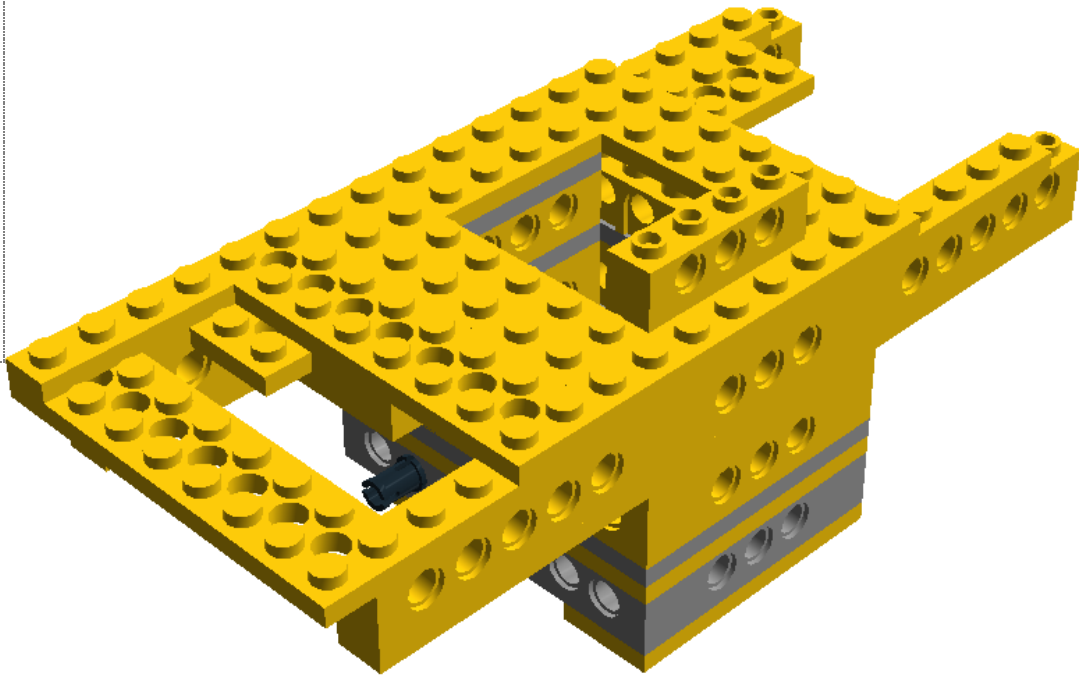

1 x



Step 17 of 41

- 1 x 
- 1 x 
- 2 x 

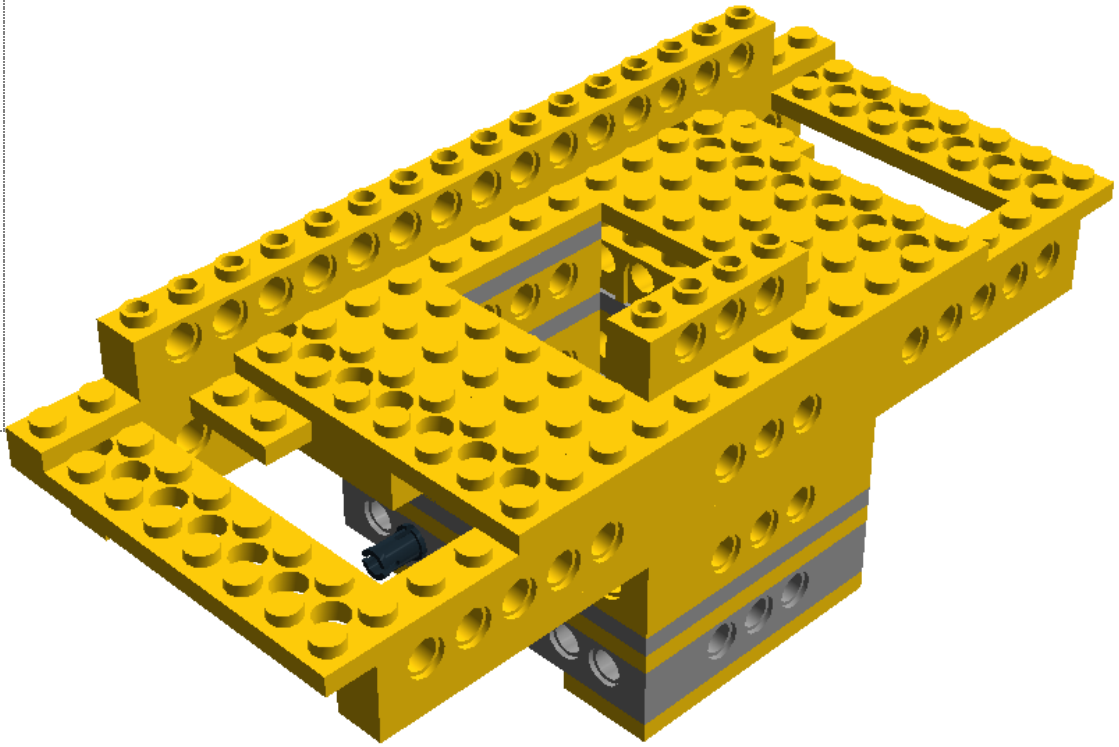

Step 18 of 41

2 x



2 x

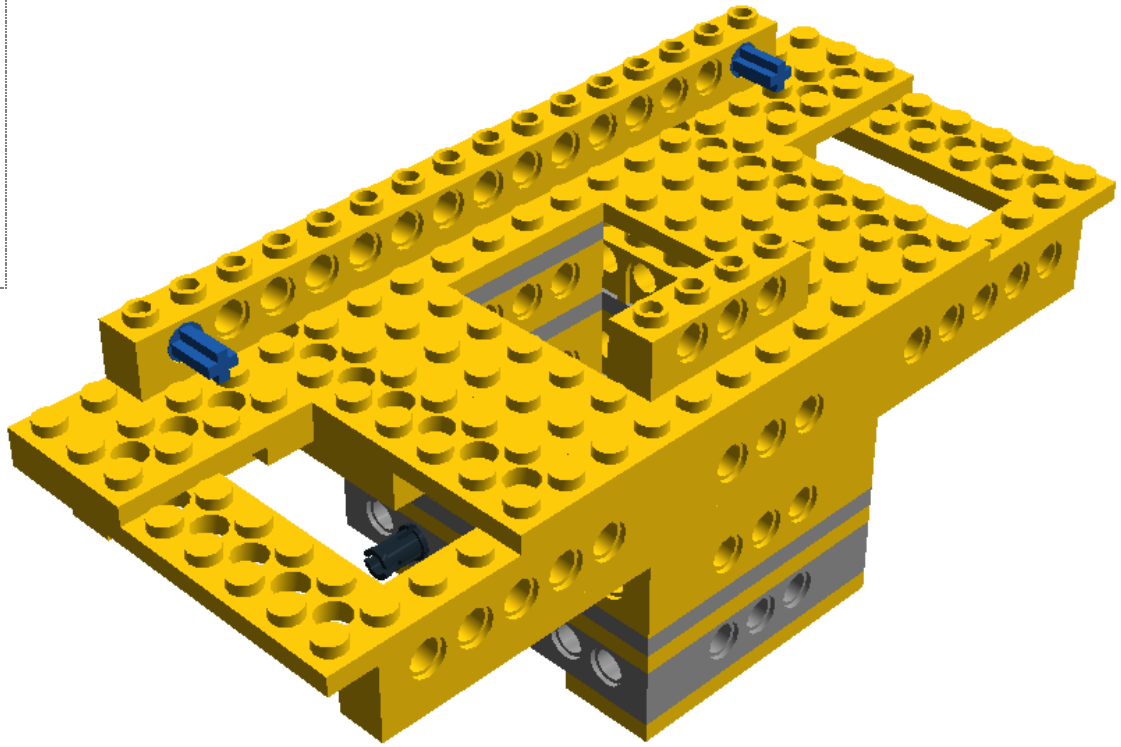

Step 19 of 41

1 x



1 x



2 x

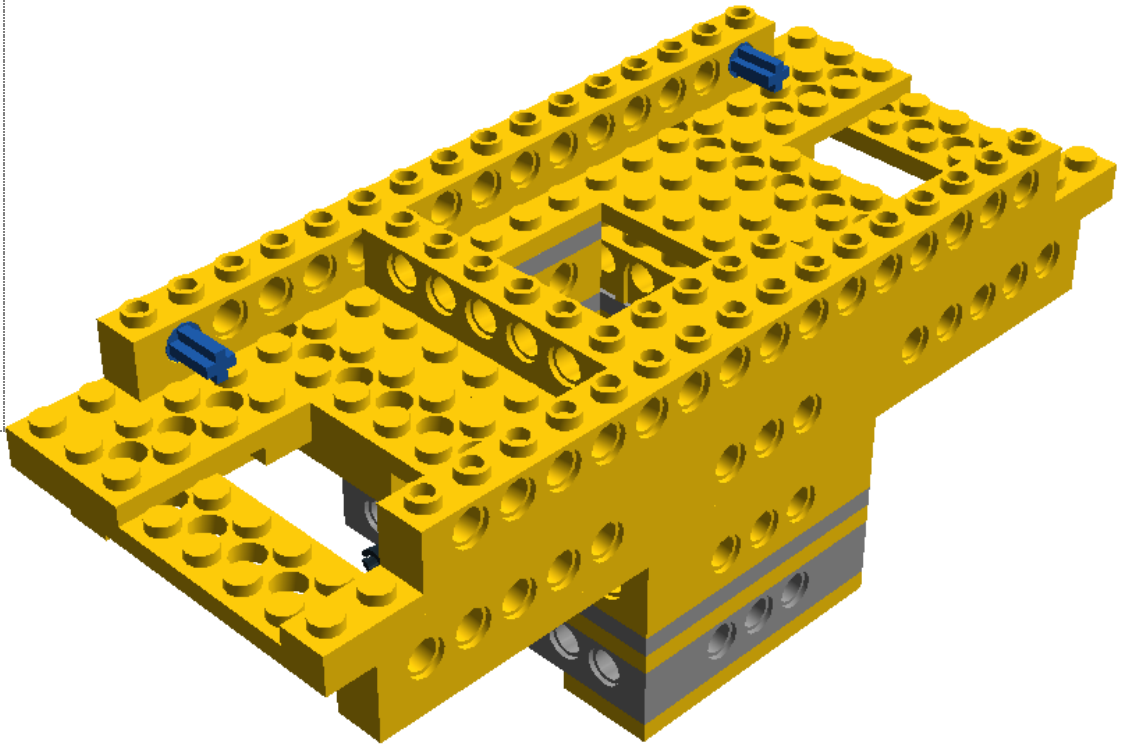

Step 20 of 41

1 x



2 x

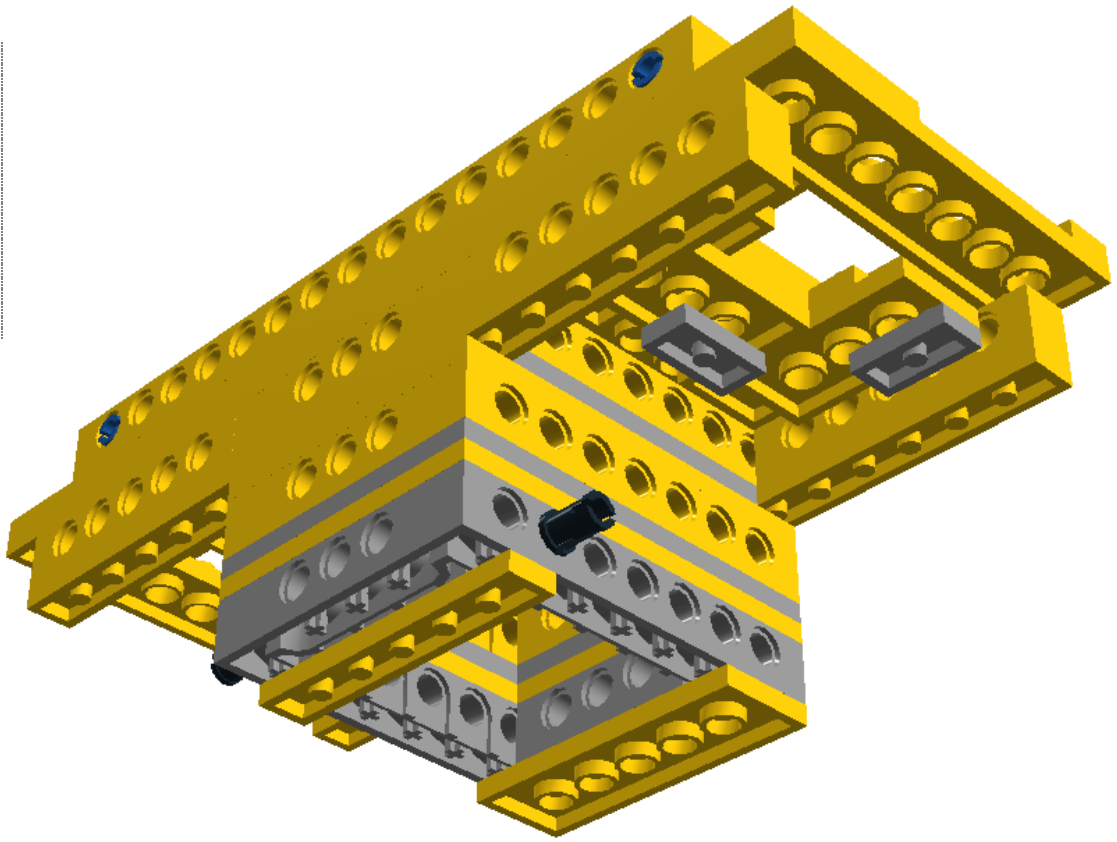

Step 21 of 41

2 x



1 x

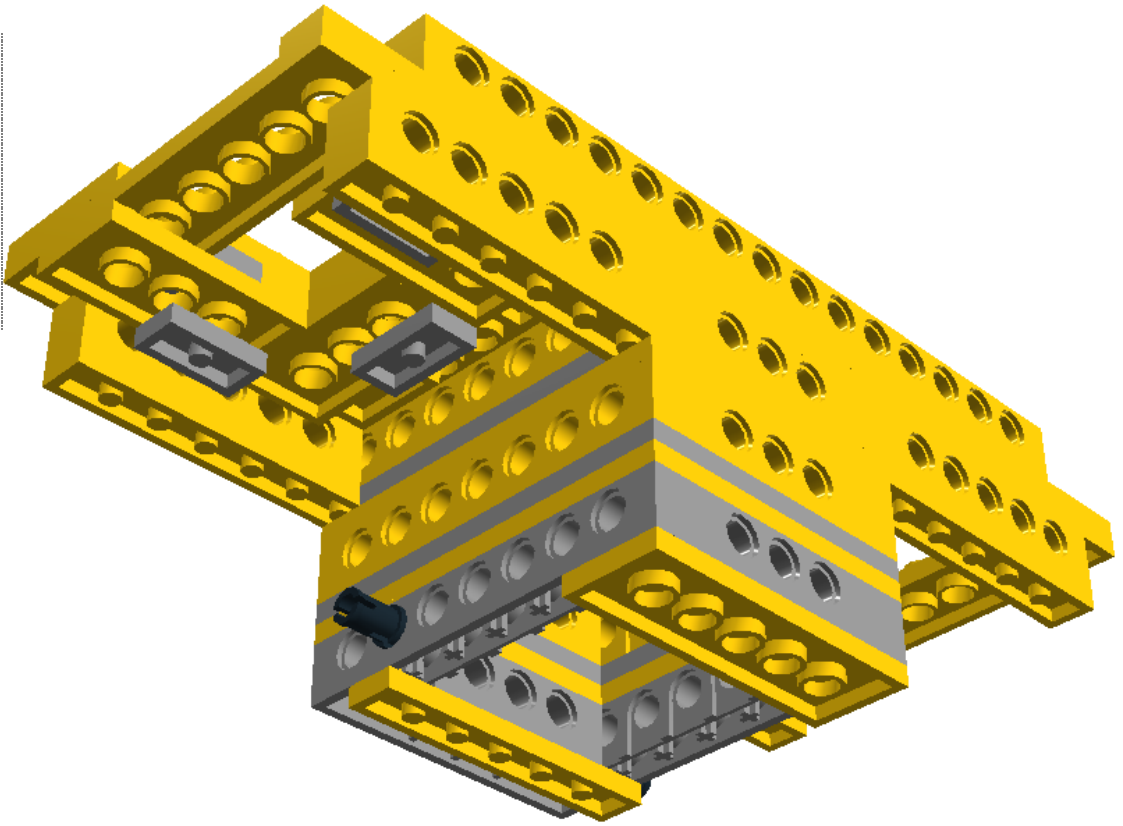

Step 22 of 41

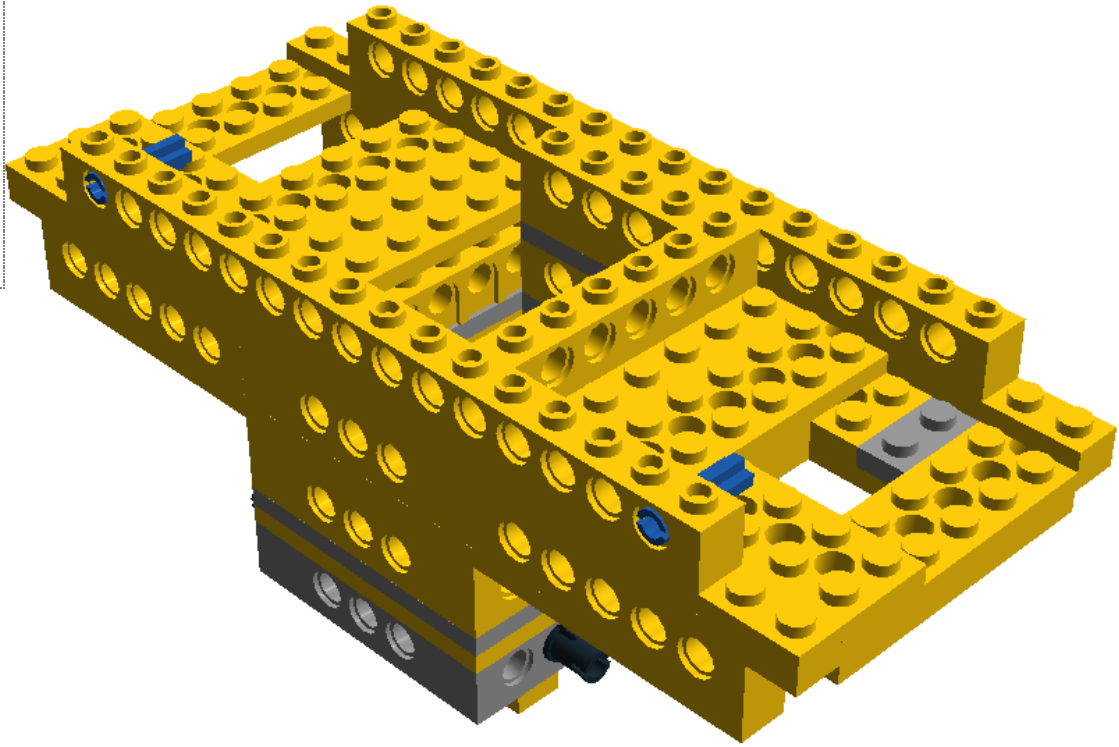
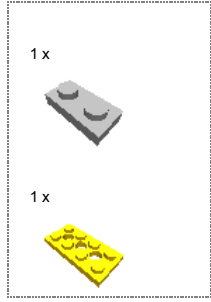

Step 23 of 41

1 x



1 x



1 x





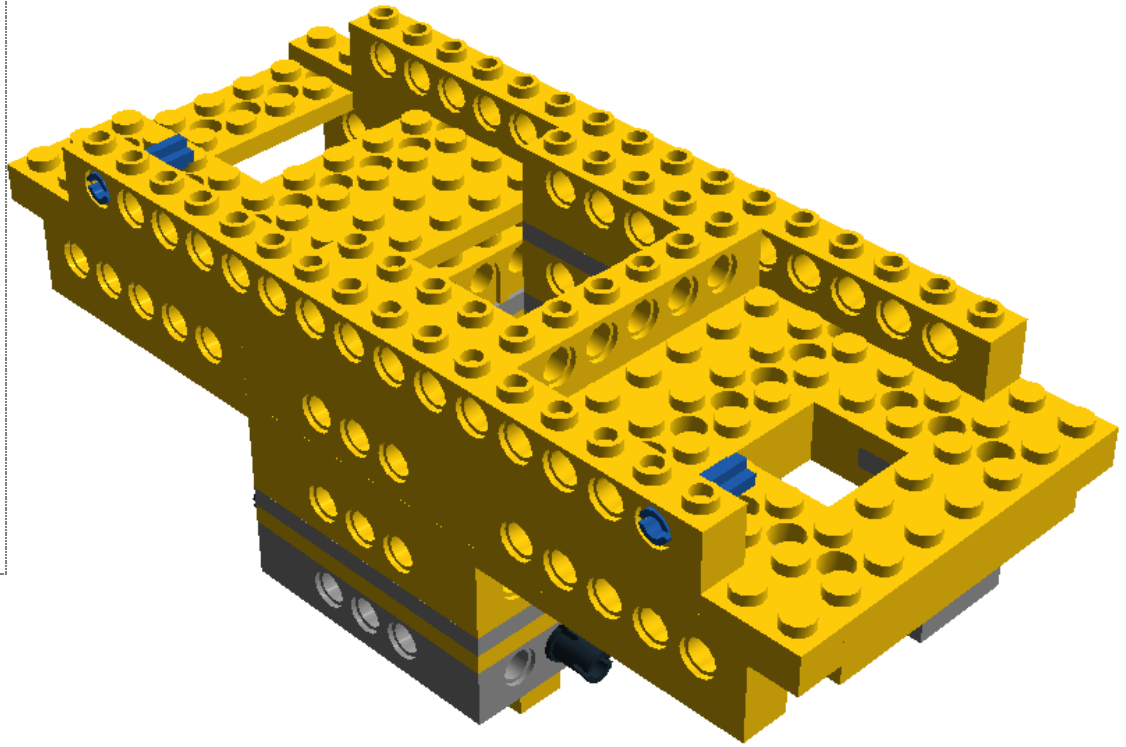

1 x





Step 24 of 41

- 1 x 
- 1 x 
- 1 x 
- 1 x 

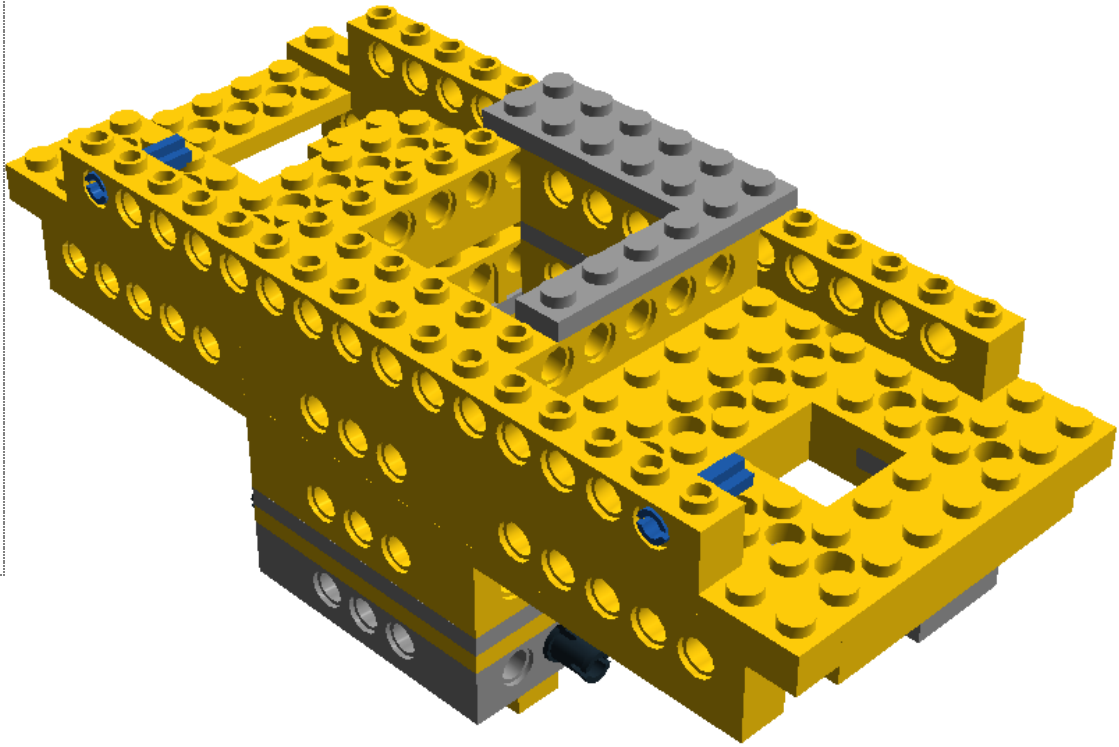

Step 25 of 41

2 x



1 x



1 x

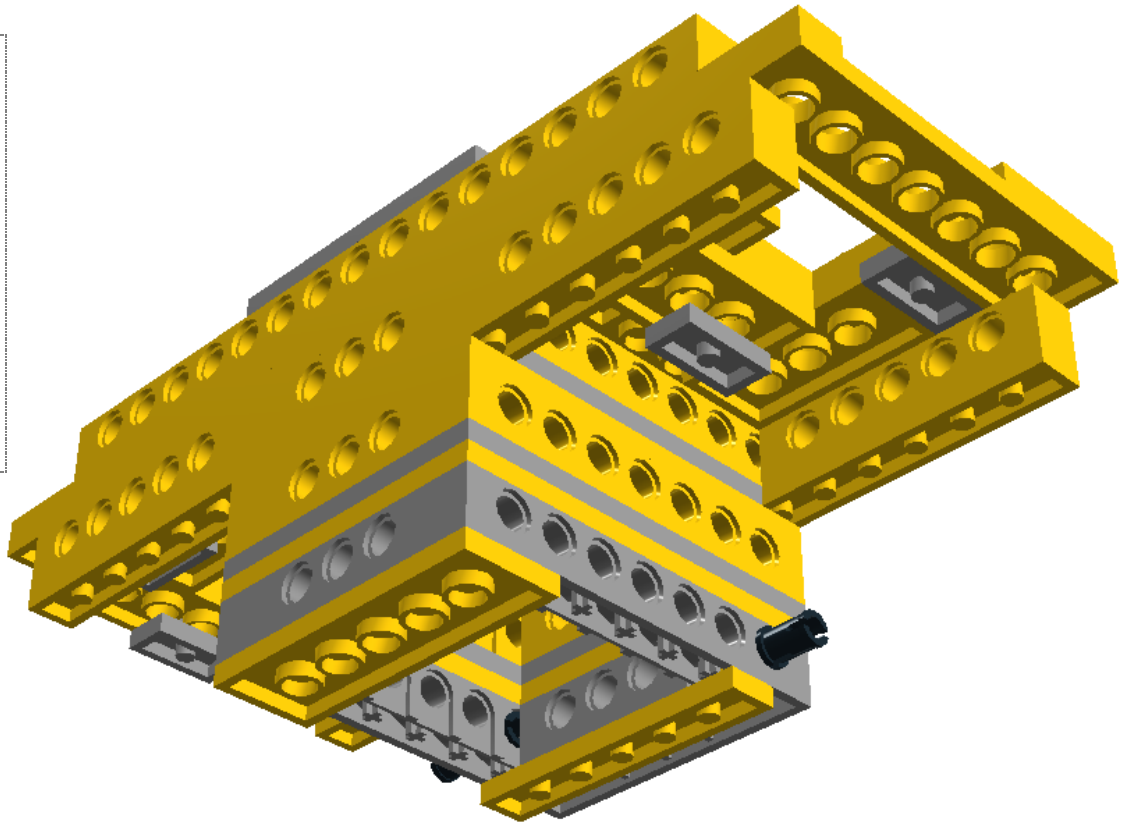

Step 26 of 41

1 x



2 x

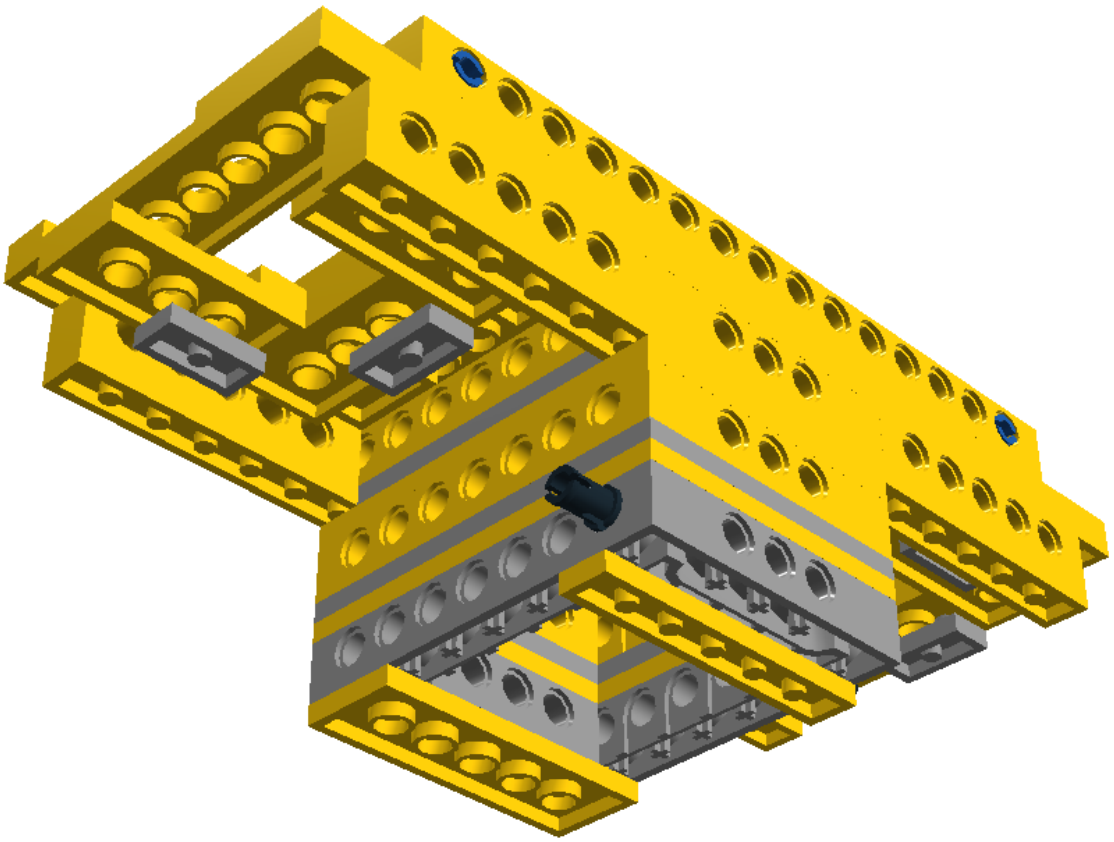

Step 27 of 41

1 x

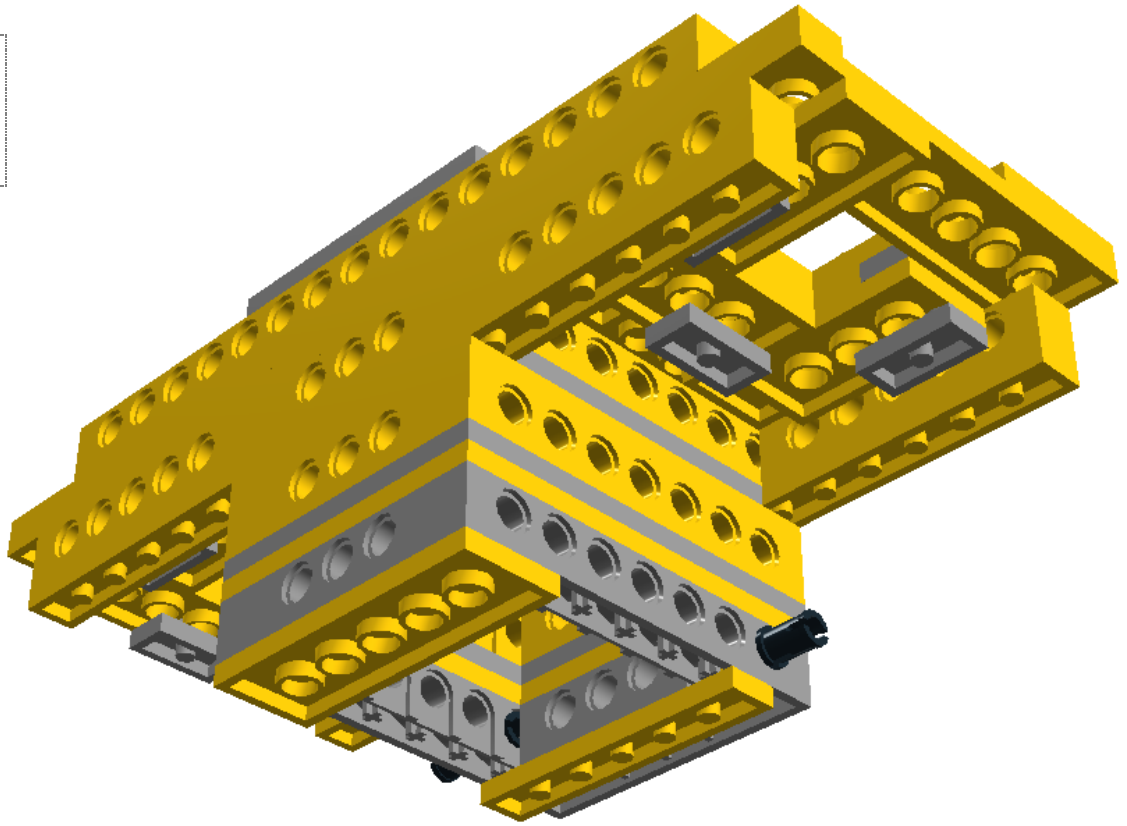

Step 28 of 41

1 x

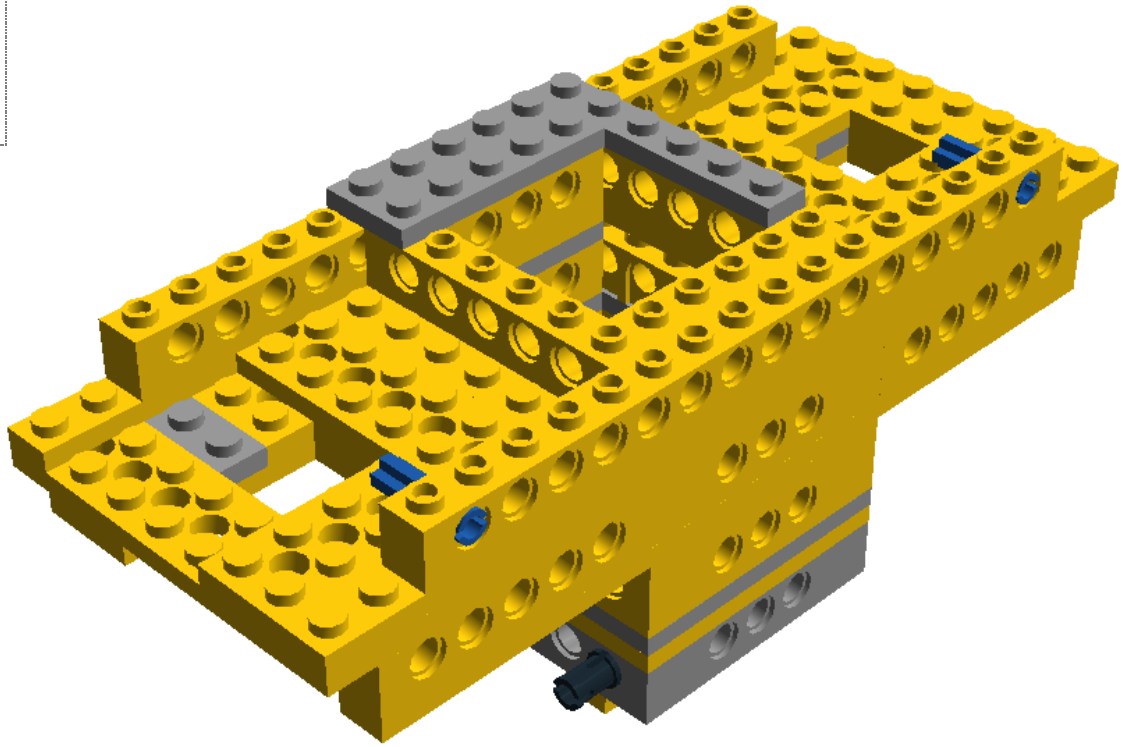

Step 29 of 41

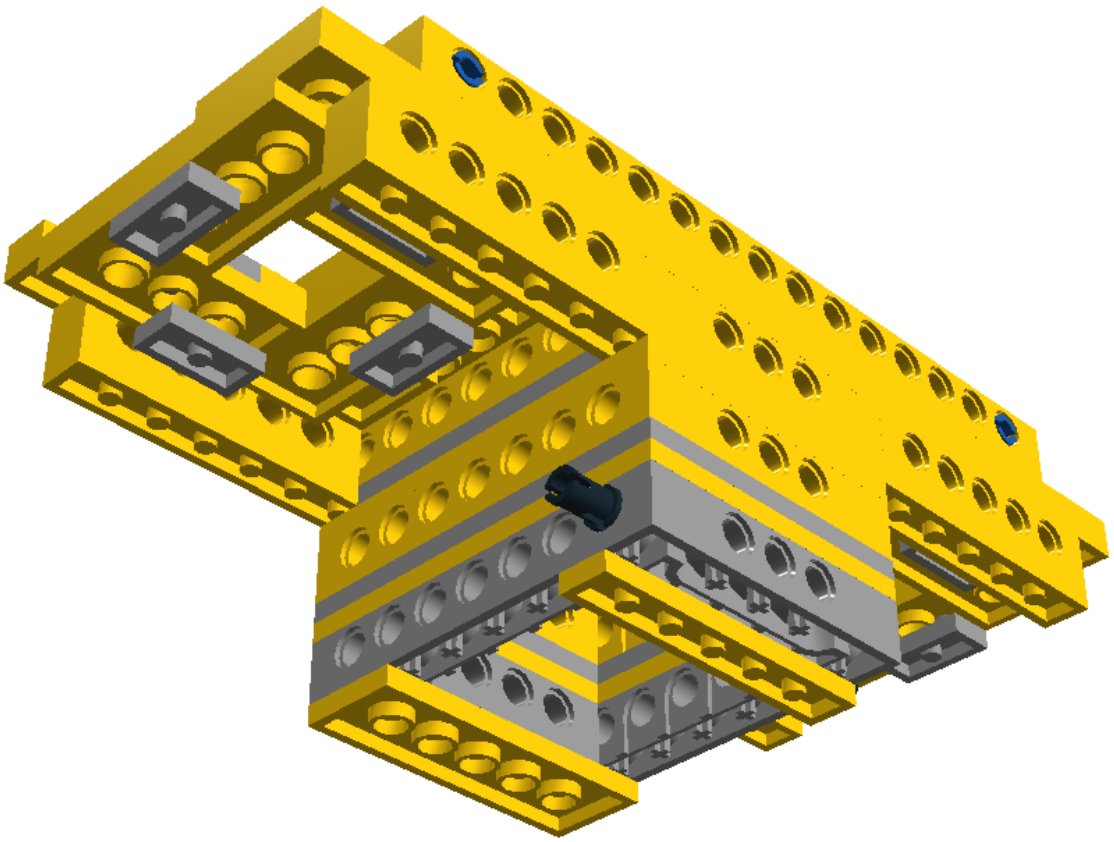
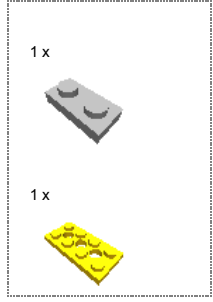

Step 30 of 41

1 x



1 x



1 x



1 x

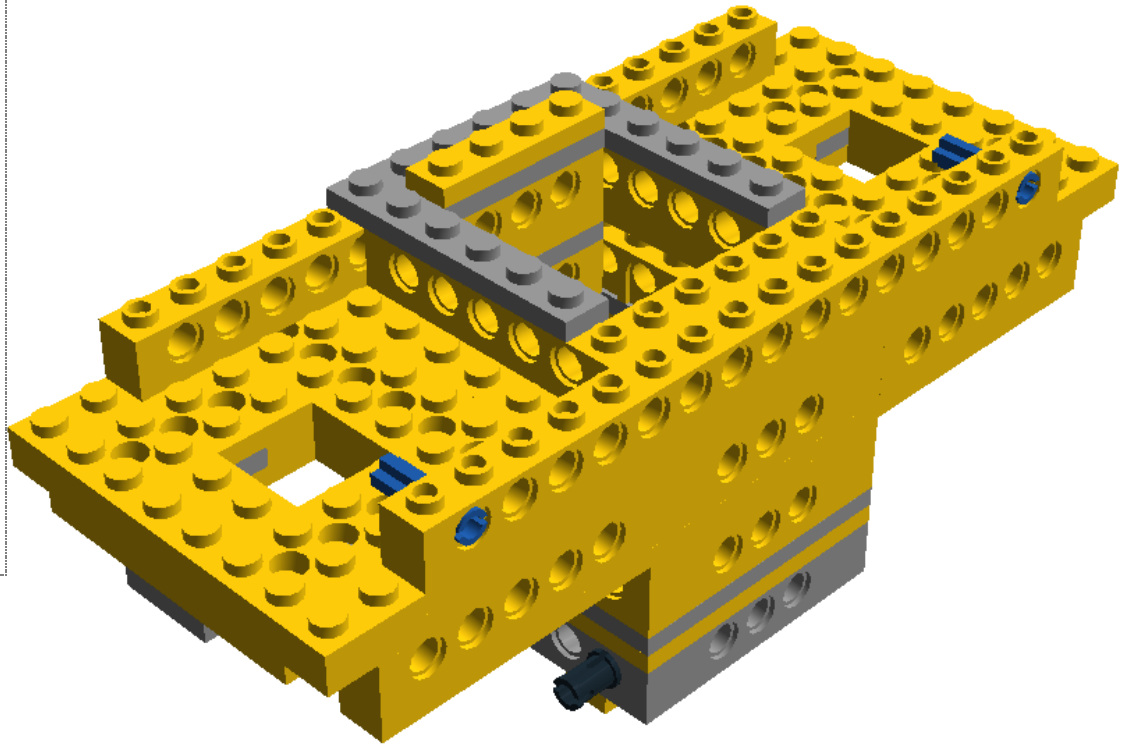

Step 31 of 41

2 x



1 x



1 x

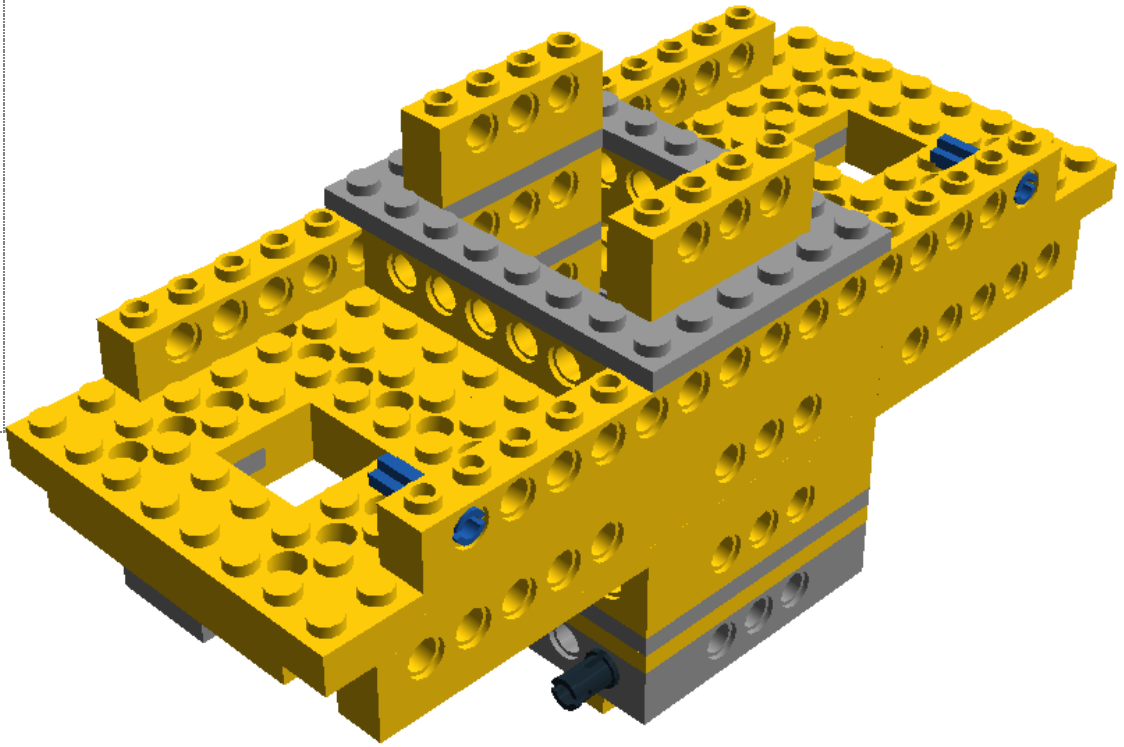



Step 32 of 41

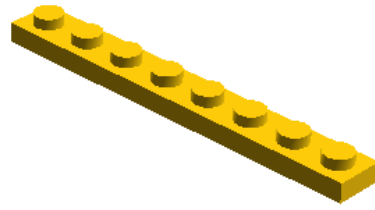
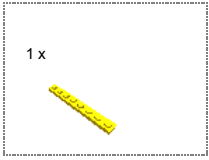

Step 33 of 41

1 x



2 x



1 x

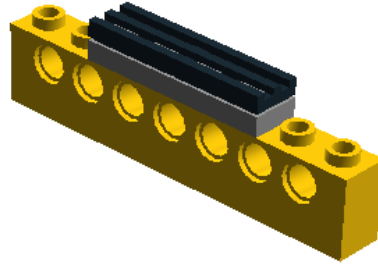

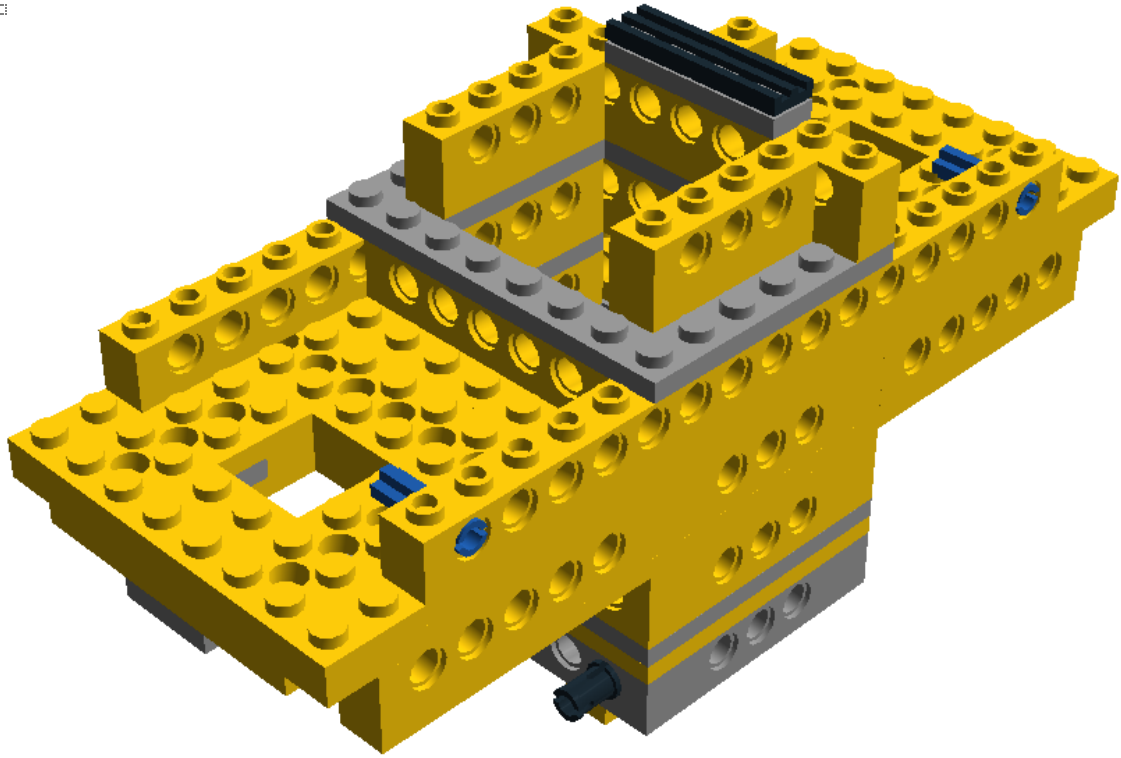

Step 35 of 41

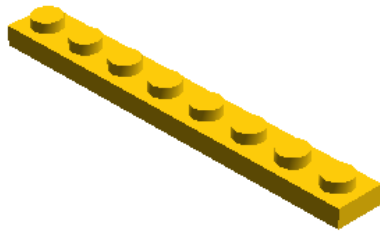

Step 36 of 41

1 x



2 x



1 x

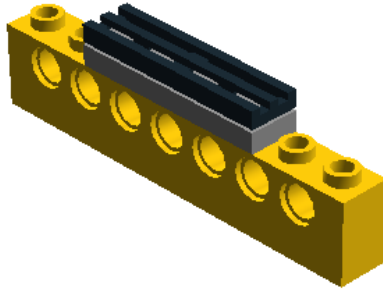

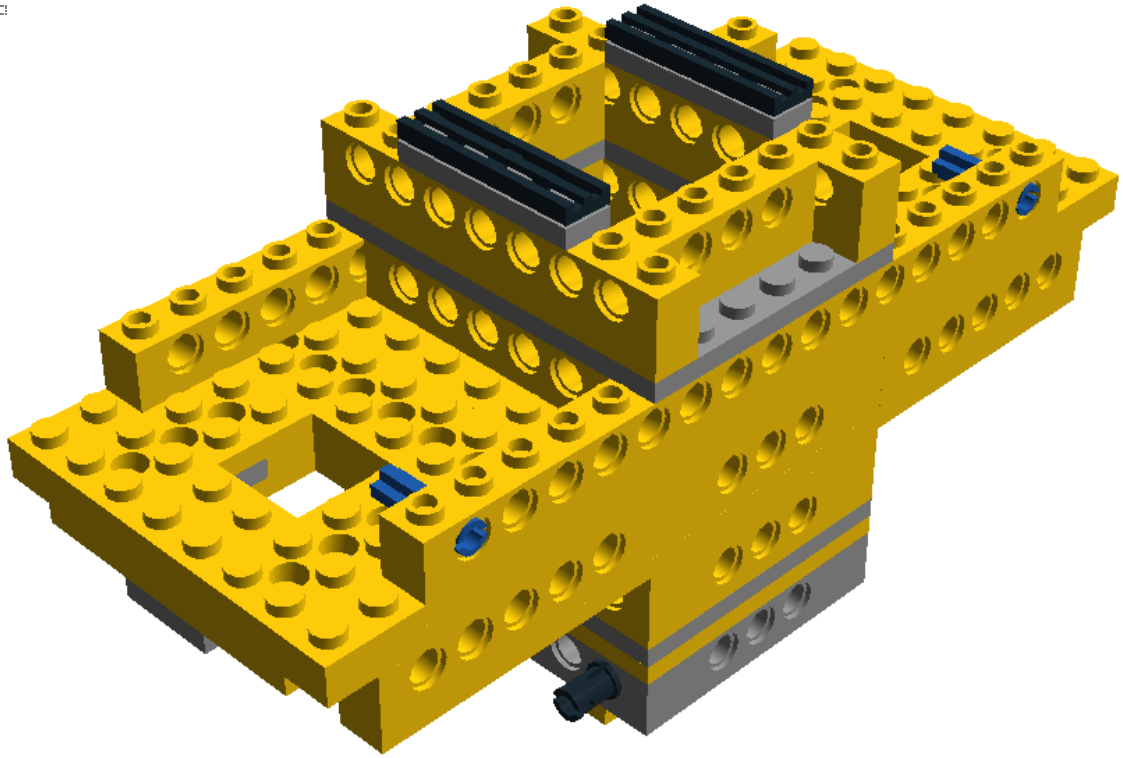

Step 38 of 41

1 x



2 x

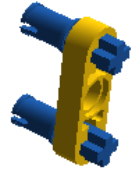

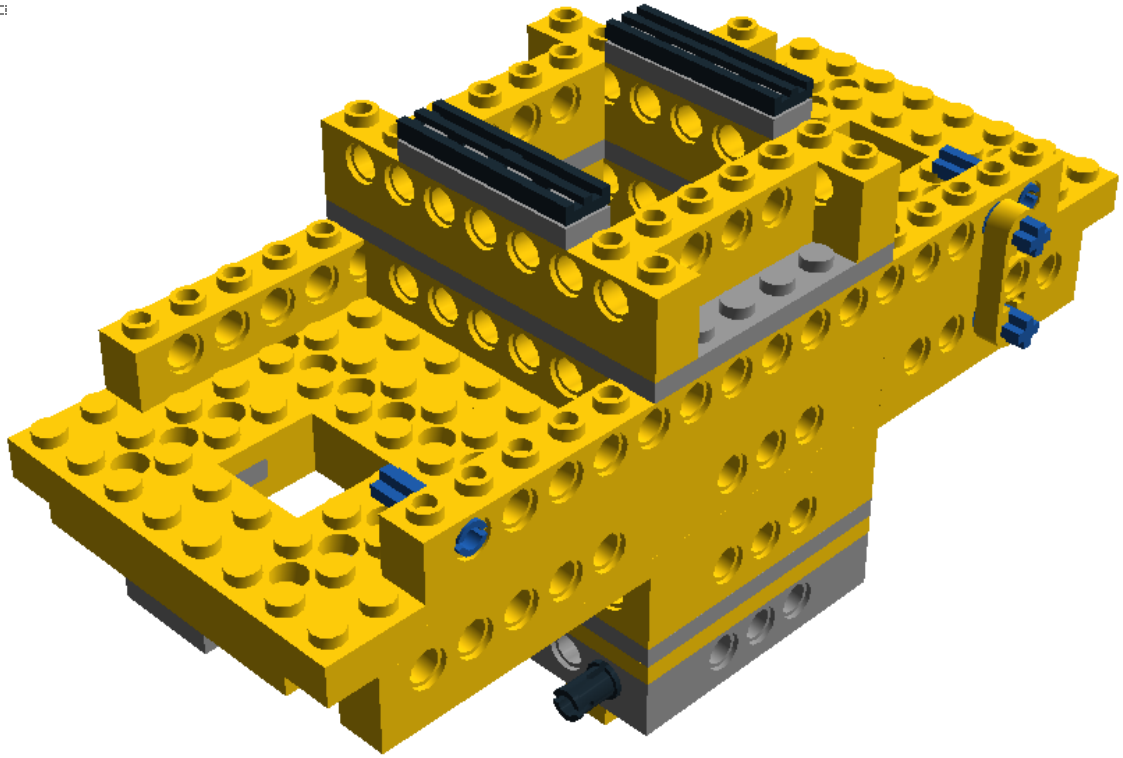



Step 40 of 41

1 x



2 x

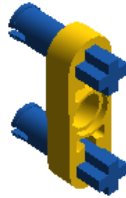

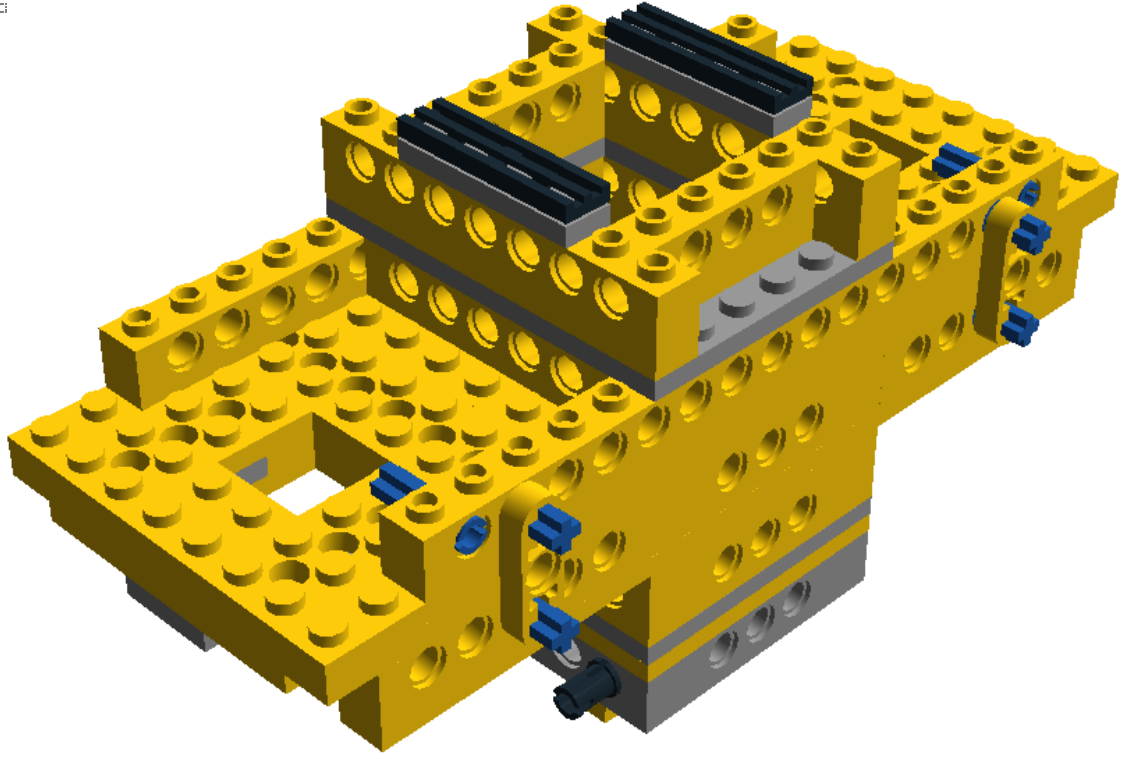

2 x  4211441 TECHNIC BRICK 1X4, Ø4,9 - Medium Stone Grey

8 x  370124 TECHNIC BRICK 1X4, Ø4,9 - Bright Yellow

6 x  389424 TECHNIC BRICK 1X6, Ø4,9 - Bright Yellow

2 x  370224 TECHNIC BRICK 1X8 - Bright Yellow

2 x  370324 TECHNIC BRICK 1X16, Ø4,9 - Bright Yellow

1 x  4211848 6X8 BRICK, Ø 4,85 - Medium Stone Grey

2 x  3253224 6X8 BRICK, Ø 4,85 - Bright Yellow

4 x  241226 RADIATOR GRILLE 1X2 - Black

12 x  4211398 PLATE 1X2 - Medium Stone Grey

4 x  362324 PLATE 1X3 - Bright Yellow

4 x  302224 PLATE 2X2 - Bright Yellow

8 x  4211445 PLATE 1X4 - Medium Stone Grey

8 x  371024 PLATE 1X4 - Bright Yellow

2 x  4211438 PLATE 1X6 - Medium Stone Grey

1 x  366624 PLATE 1X6 - Bright Yellow

2 x  4211395 PLATE 2X4 - Medium Stone Grey

4 x  302024 PLATE 2X4 - Bright Yellow

2 x  4211425 PLATE 1X8 - Medium Stone Grey

6 x  346024 PLATE 1X8 - Bright Yellow

4 x  447724 PLATE 1X10 - Bright Yellow

2 x  4211452 PLATE 2X6 - Medium Stone Grey

3 x  379524 PLATE 2X6 - Bright Yellow

2 x  303424 PLATE 2X8 - Bright Yellow

16 x  370924 PLATE 2X4, 3XØ4,9 - Bright Yellow

4 x  373824 PLATE 2X8 W. HOLES - Bright Yellow

2 x  663224 TECHNIC LEVER 3M - Bright Yellow

2 x  278026 CONNECTOR PEG W. FRICTION - Black

6 x  4225927 CONNECTOR PEG/CROSS AXLE - Bright Blue

