

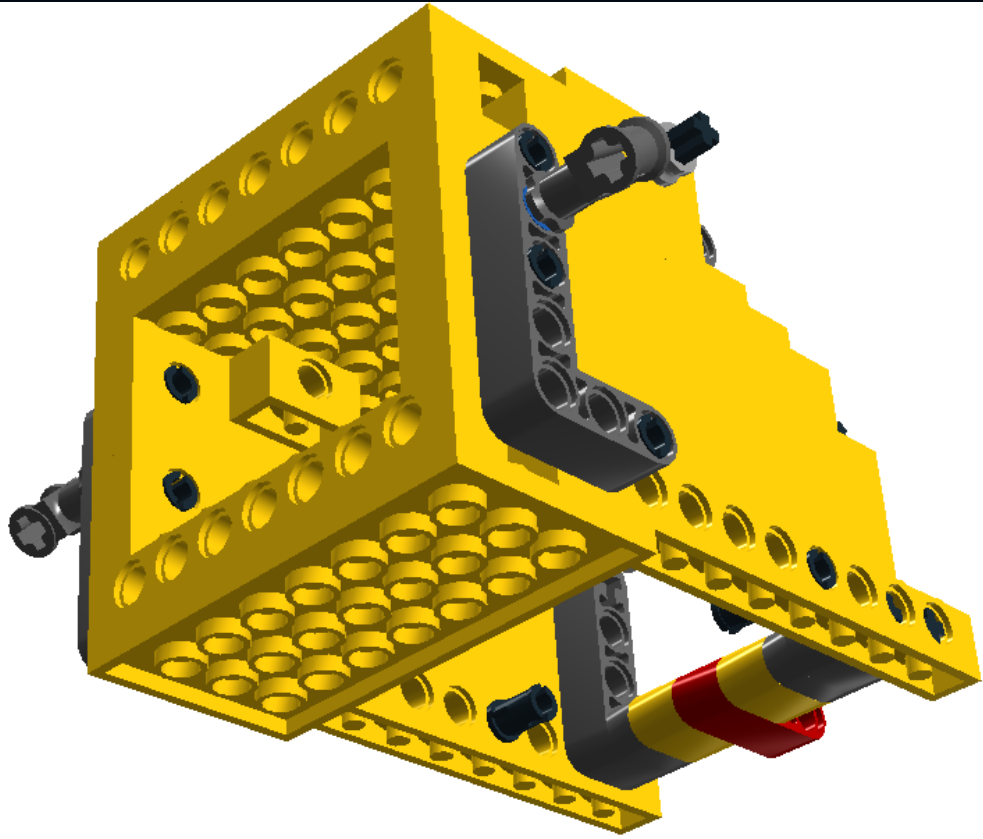

Model Name:  
**LEGO Extruder - Fan Duct**  
Number of Bricks: 83



Step 1 of 29

1 x



1 x

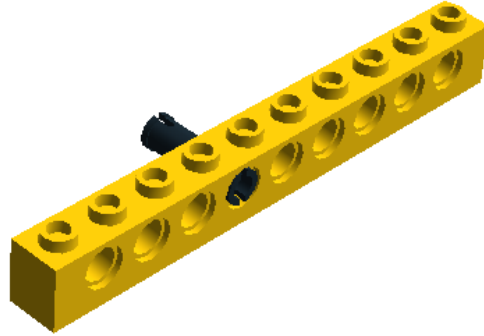

Step 2 of 29

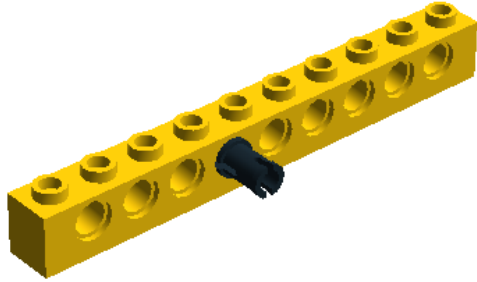
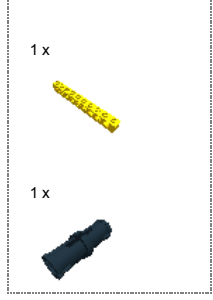

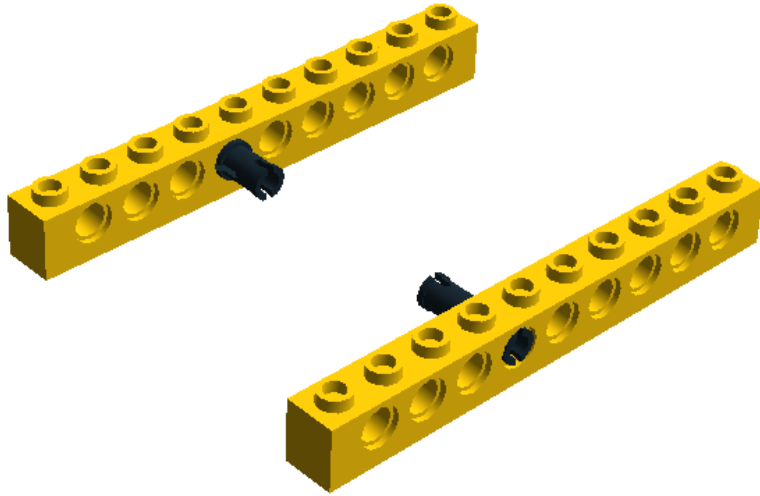



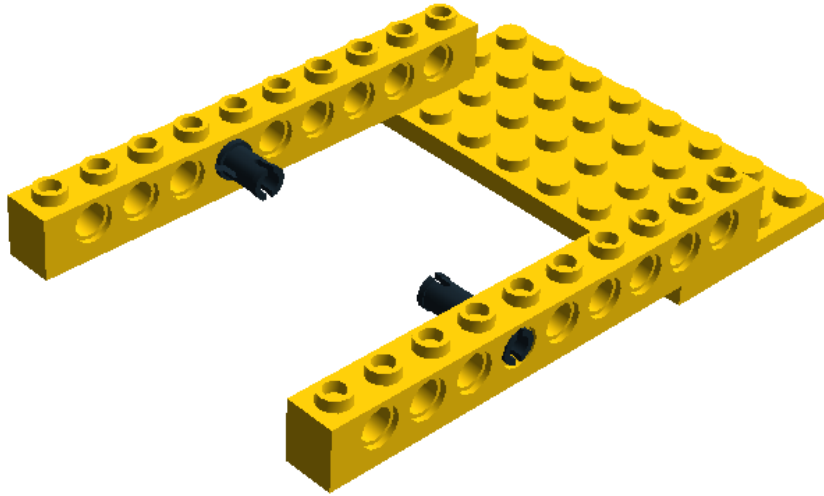

Step 4 of 29

1 x





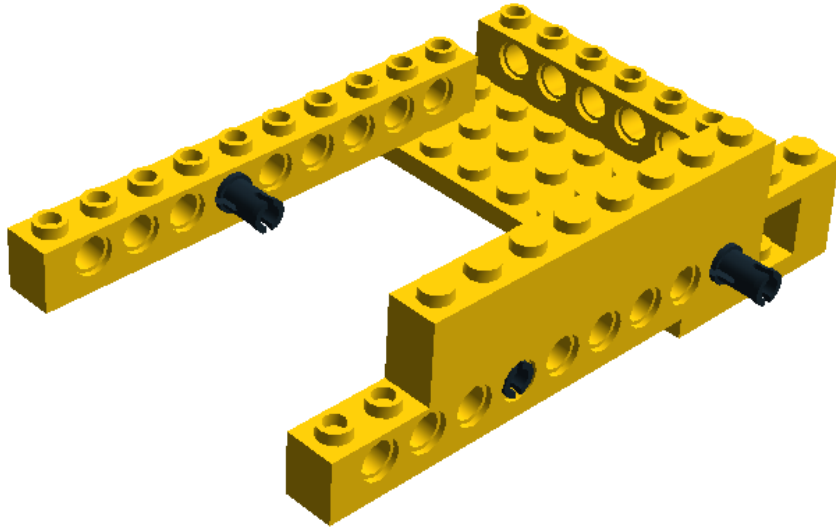

Step 5 of 29

- 1 x 
- 1 x 
- 1 x 
- 1 x 



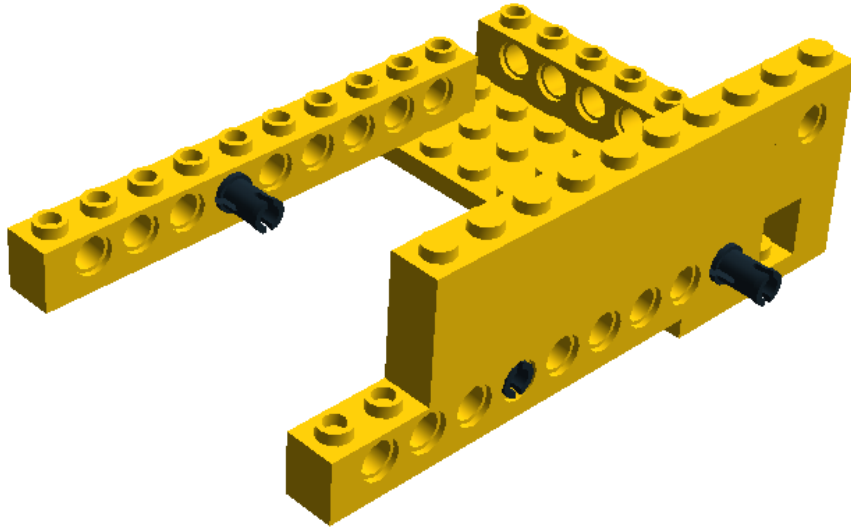

Step 6 of 29

- 1 x 
- 1 x 
- 1 x 
- 1 x 



Step 7 of 29

- 1 x 
- 1 x 
- 2 x 

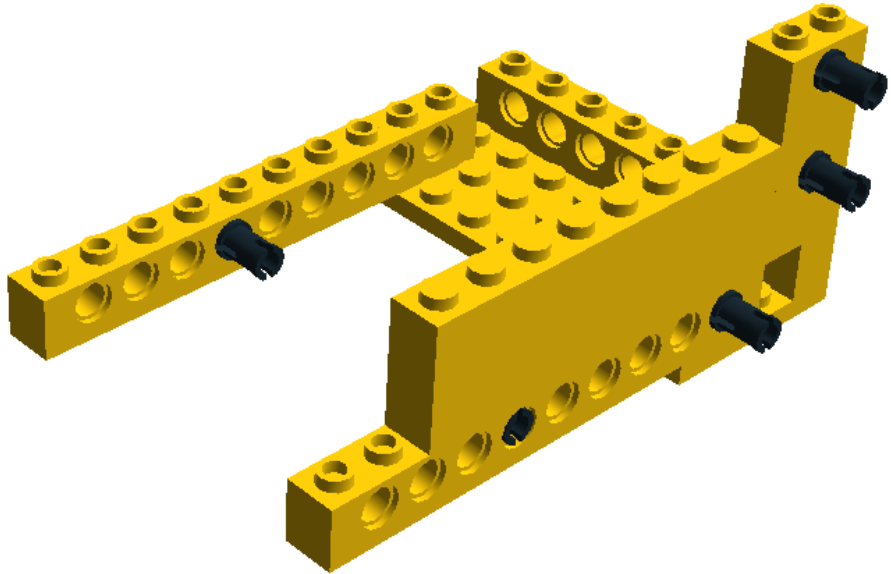



Step 8 of 29

2 x



1 x



1 x

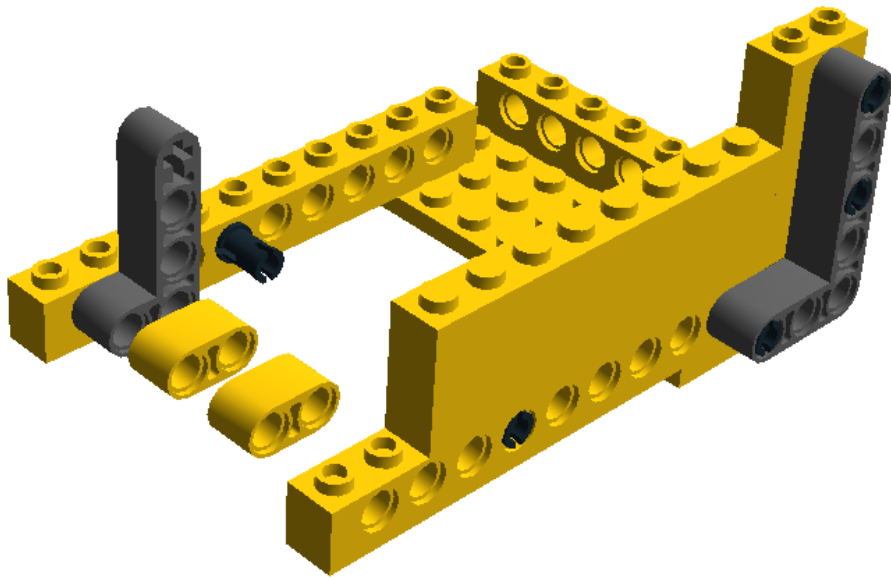

Step 9 of 29

1 x



1 x



2 x

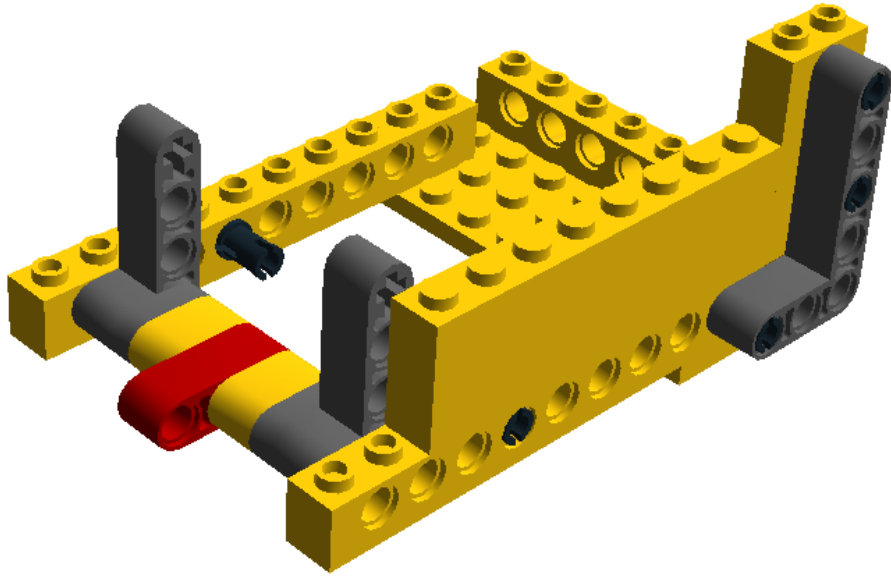

Step 10 of 29

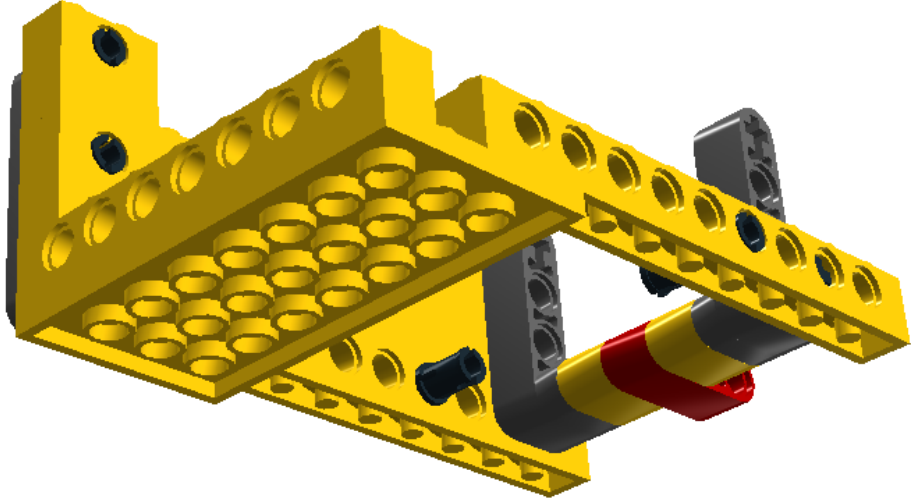



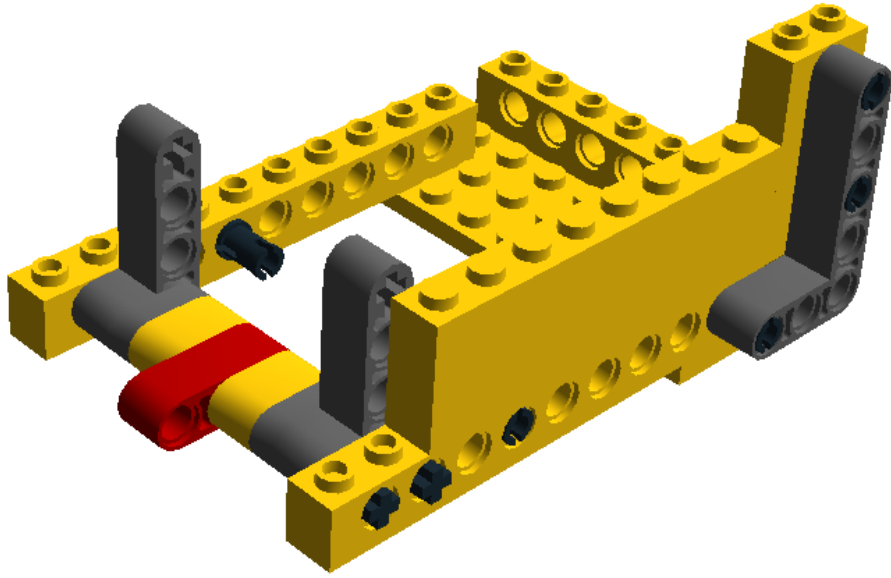

Step 11 of 29

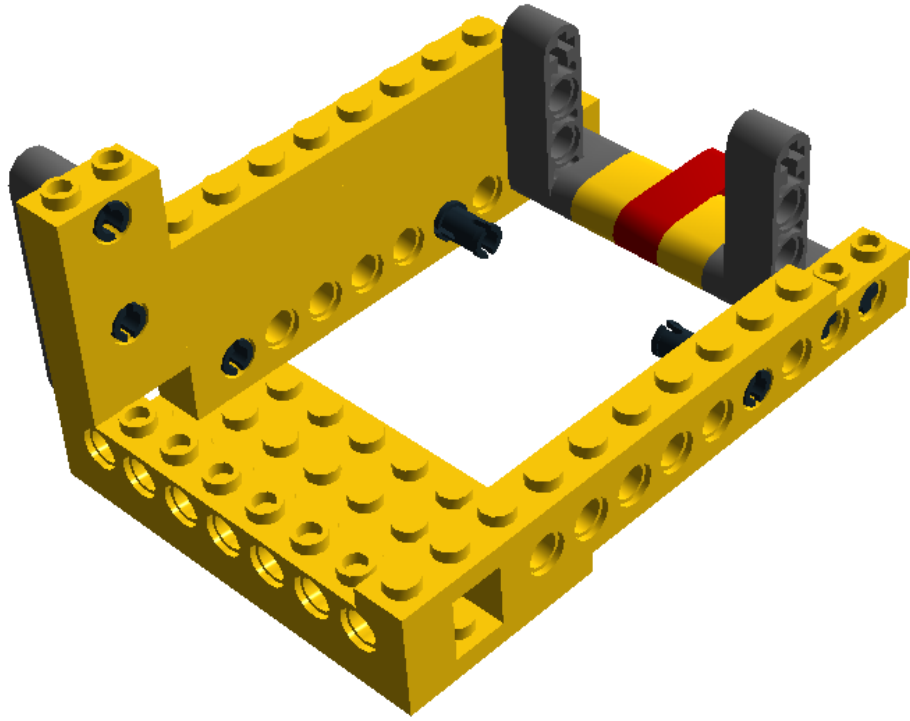

Step 12 of 29





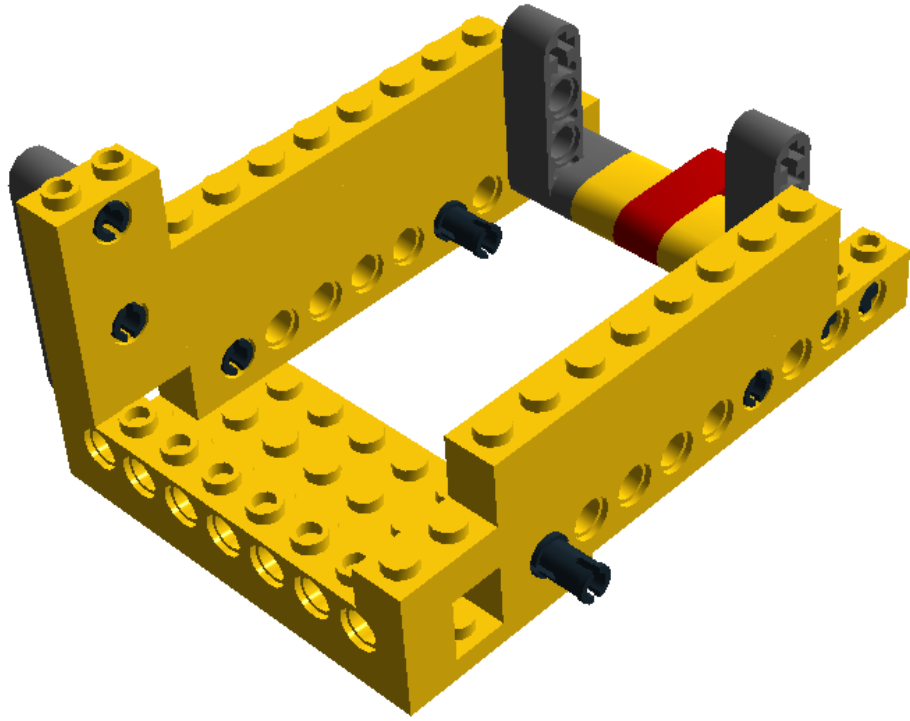

Step 13 of 29

- 1 x 
- 1 x 
- 1 x 
- 1 x 



Step 14 of 29

- 1 x 
- 1 x 
- 1 x 
- 1 x 

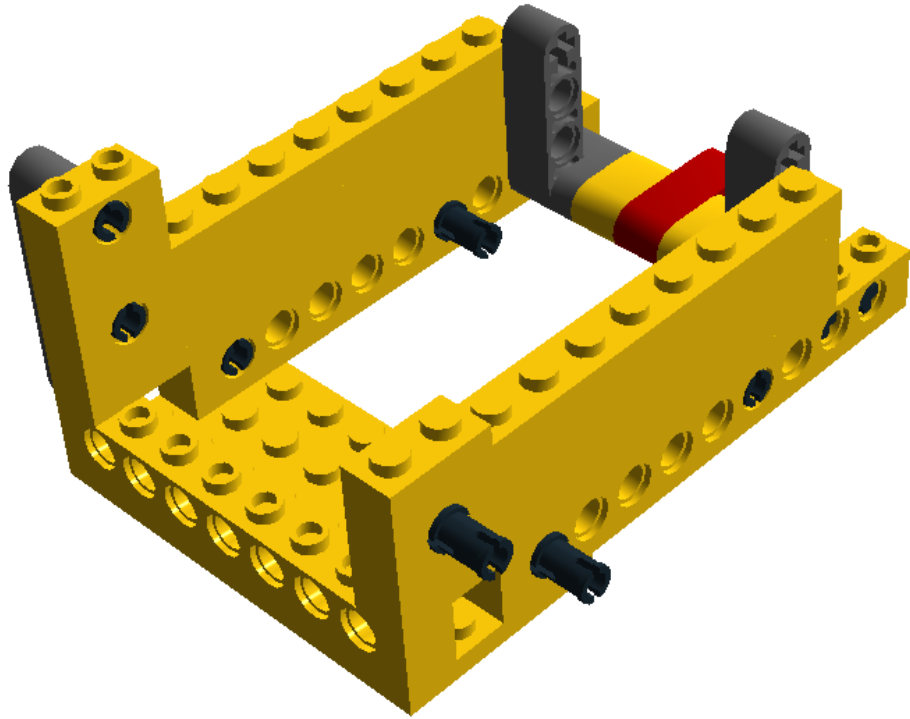

Step 15 of 29

1 x



1 x





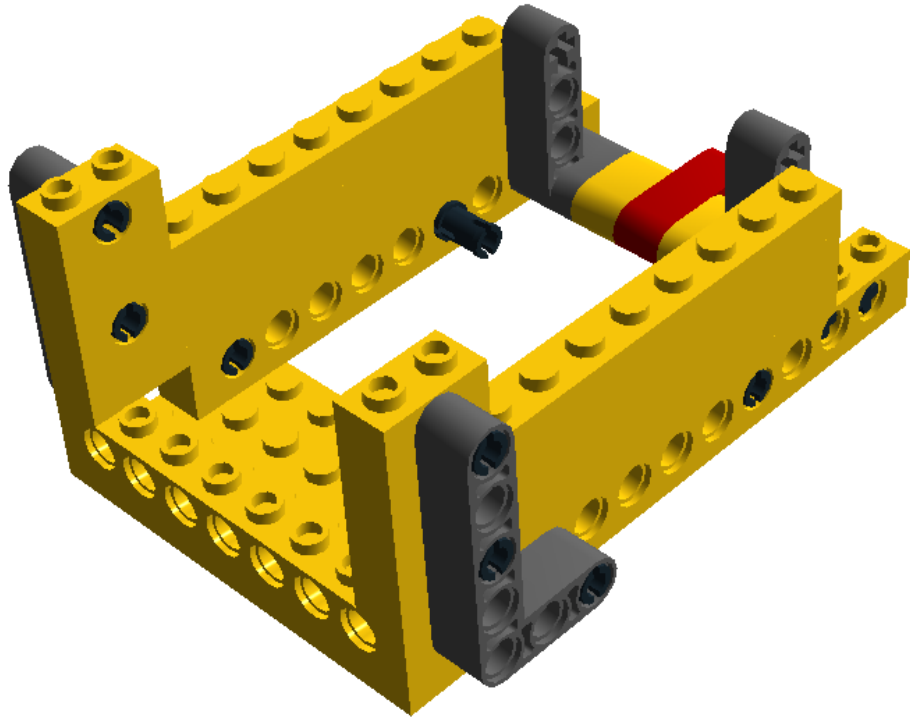

1 x







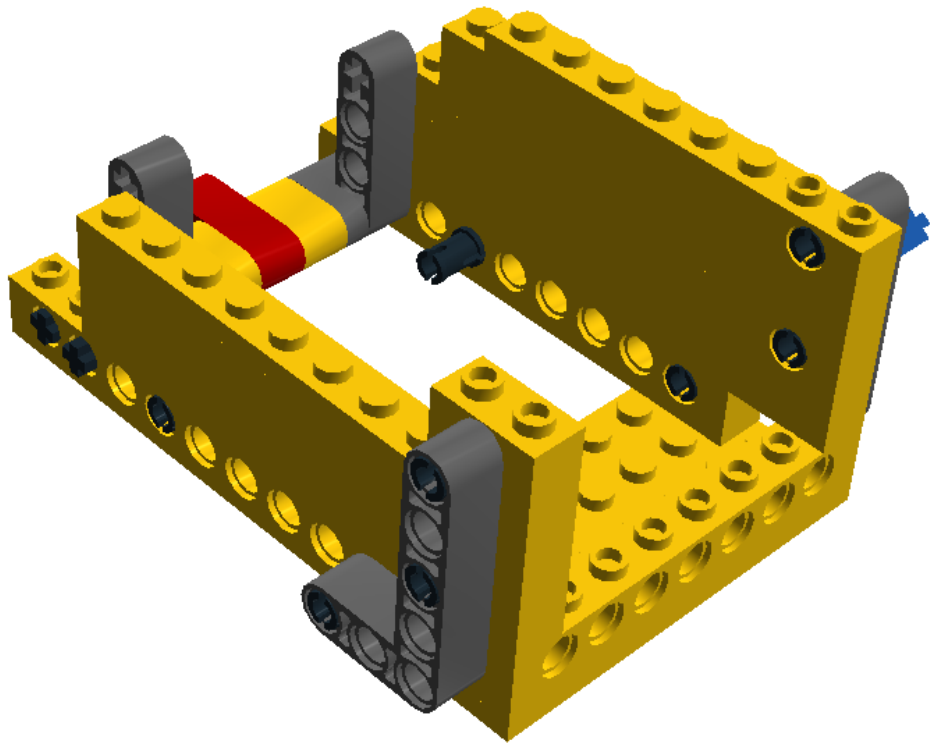

Step 16 of 29

- 1 x 
- 1 x 
- 1 x 
- 1 x 





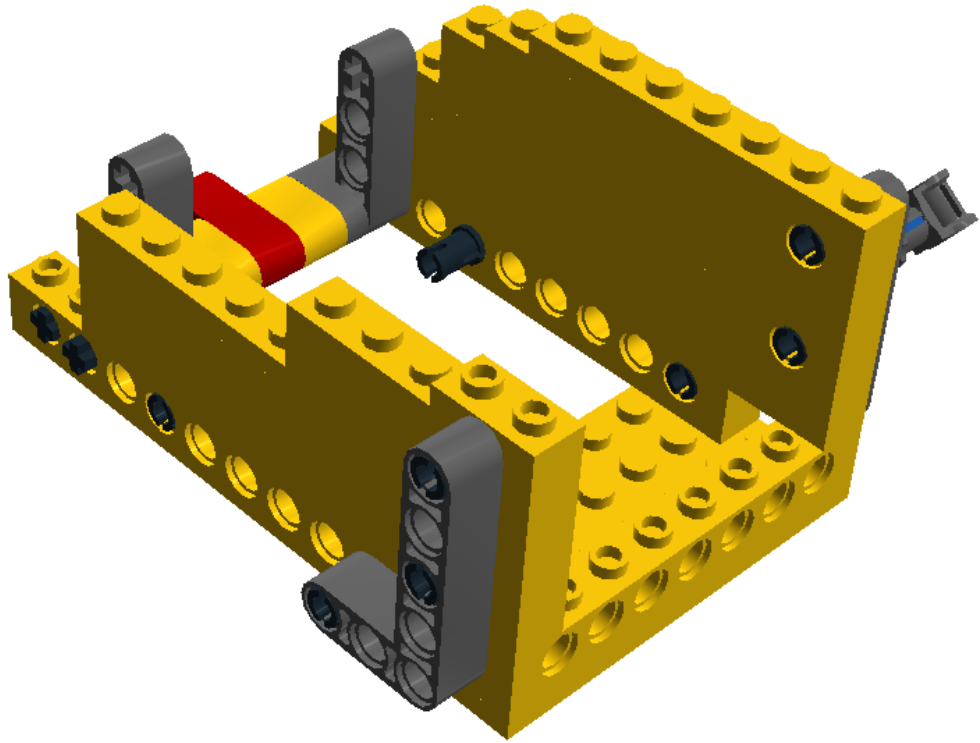

Step 17 of 29

- 1 x 
- 1 x 
- 1 x 
- 1 x 



Step 18 of 29

- 1 x 
- 1 x 
- 1 x 
- 1 x 

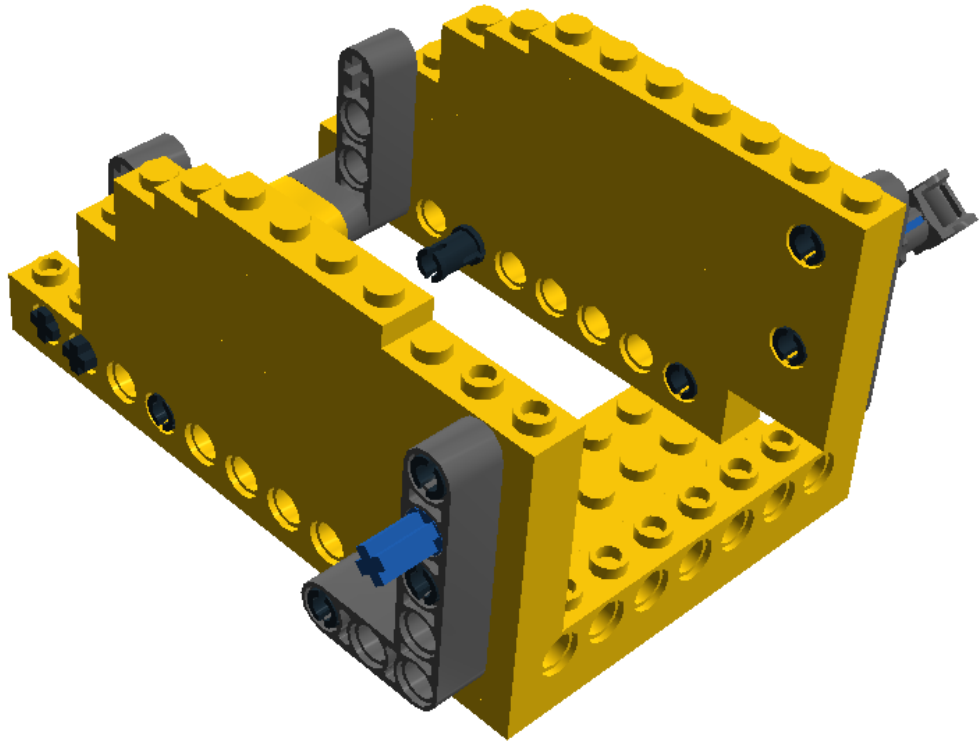

Step 19 of 29

1 x



1 x



1 x

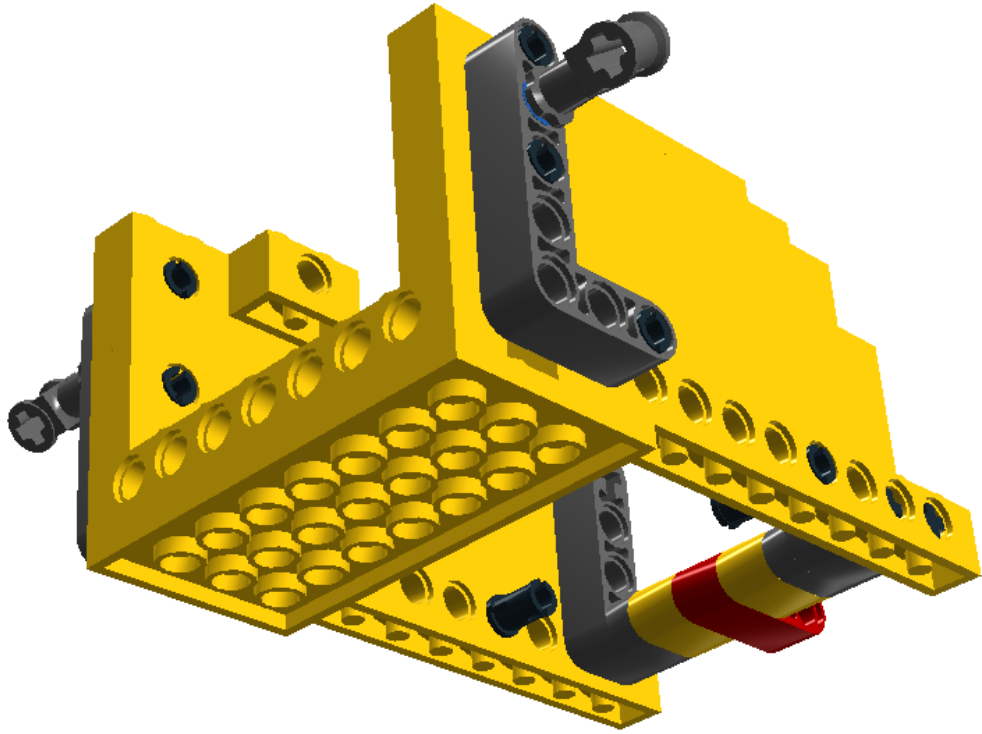

Step 20 of 29



Step 21 of 29

2 x



1 x



1 x

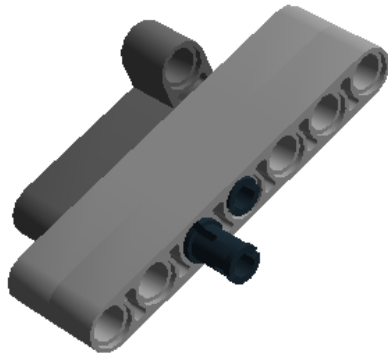

Step 22 of 29

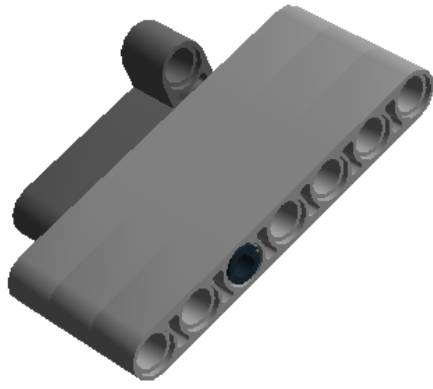
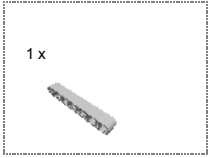

Step 23 of 29

1 x



1 x



2 x

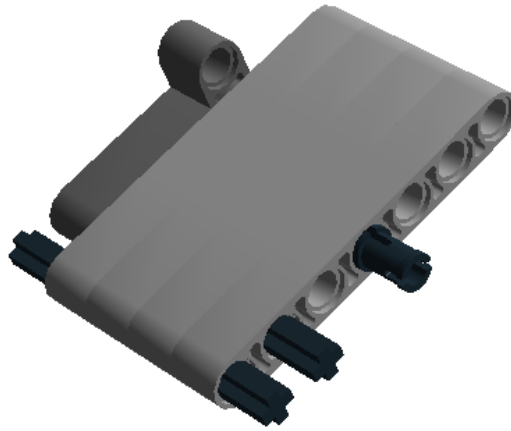



Step 24 of 29

2 x



1 x



1 x

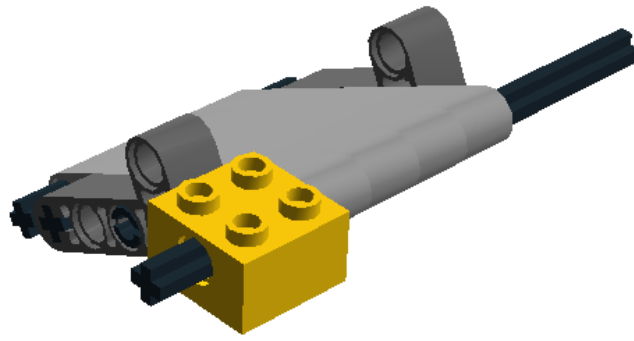

Step 25 of 29

2 x



2 x

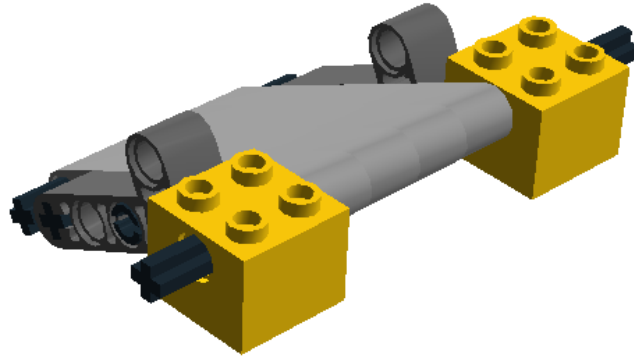

Step 26 of 29

1 x



1 x



1 x

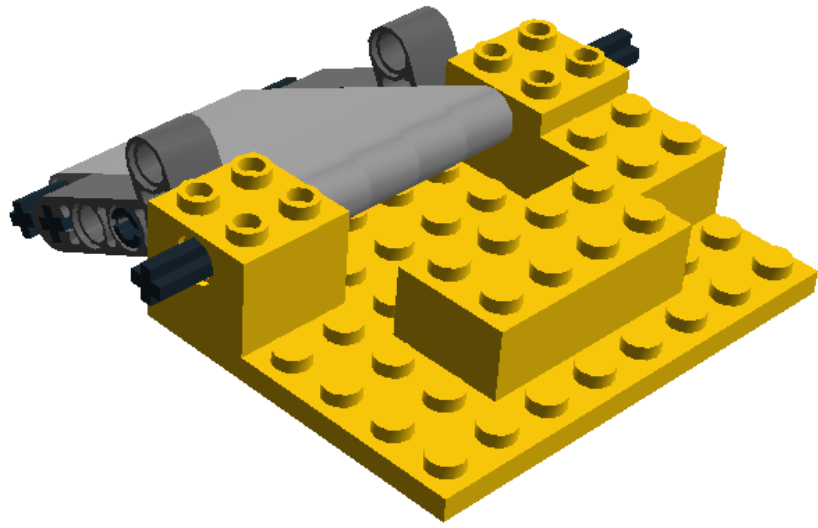

Step 27 of 29

1 x



1 x



1 x



1 x

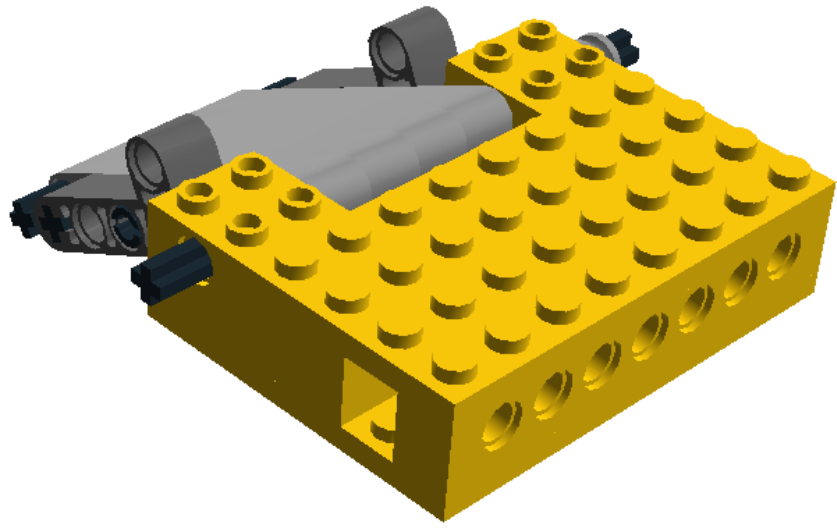

Step 28 of 29

2 x









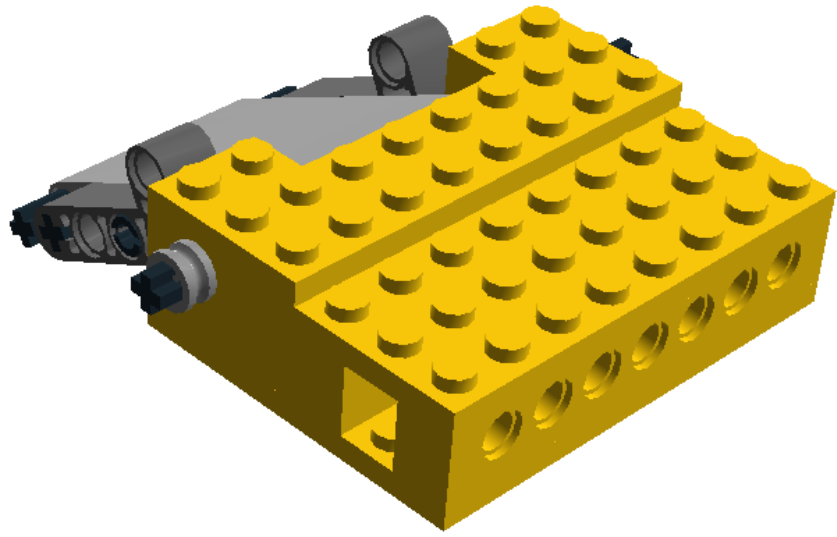

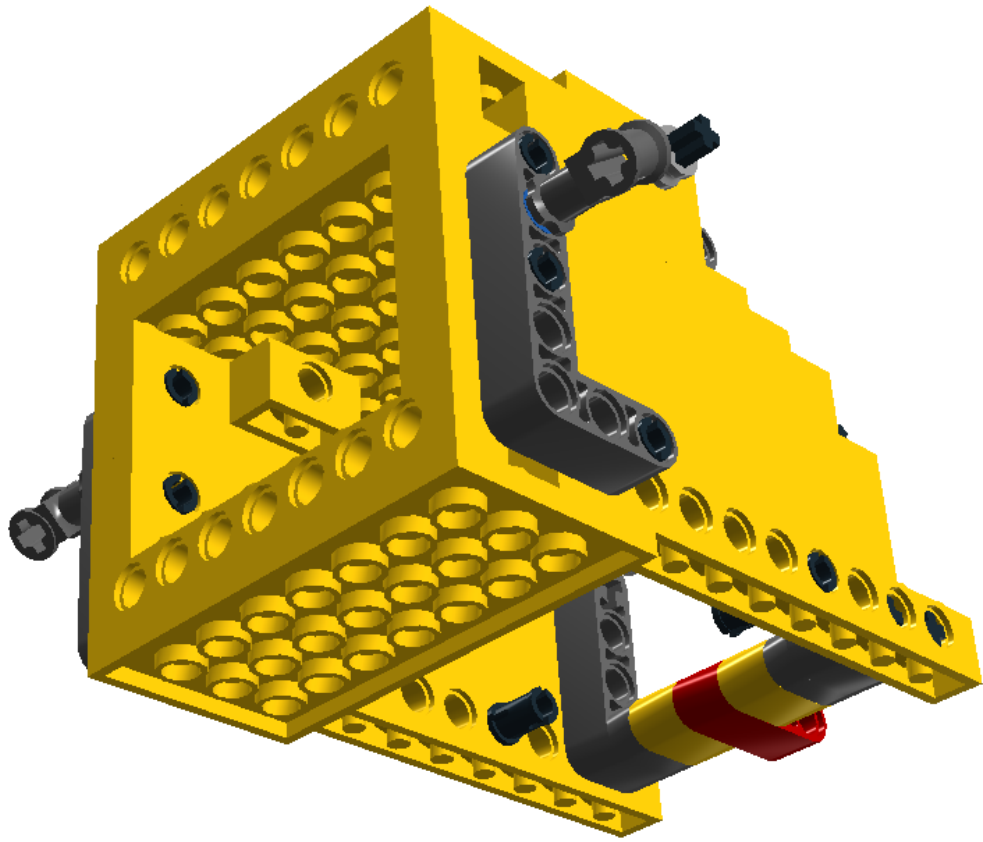























1 x



1 x





2 x  362224 BRICK 1X3 - Bright Yellow	2 x  300324 BRICK 2X2 - Bright Yellow	2 x  301024 BRICK 1X4 - Bright Yellow
1 x  300124 BRICK 2X4 - Bright Yellow	2 x  300824 BRICK 1X8 - Bright Yellow	9 x  370024 TECHNIC BRICK 1X2, Ø4.9 - Bright Yellow
2 x  370224 TECHNIC BRICK 1X8 - Bright Yellow	2 x  273024 TECHNIC BRICK 1X10 Ø4.9 - Bright Yellow	4 x  302324 PLATE 1X2 - Bright Yellow
2 x  362324 PLATE 1X3 - Bright Yellow	2 x  302224 PLATE 2X2 - Bright Yellow	2 x  371024 PLATE 1X4 - Bright Yellow
2 x  302124 PLATE 2X3 - Bright Yellow	2 x  366624 PLATE 1X6 - Bright Yellow	1 x  302024 PLATE 2X4 - Bright Yellow
2 x  346024 PLATE 1X8 - Bright Yellow	4 x  447724 PLATE 1X10 - Bright Yellow	2 x  303524 PLATE 4X8 - Bright Yellow
1 x  303624 PLATE 6X8 - Bright Yellow	2 x  4187122 TECHNIC 2M BEAM - Bright Yellow	1 x  4153718 TECHNIC 3M BEAM - Bright Red
4 x  4211665 TECHNIC 7M BEAM - Medium Stone Grey	4 x  4210667 TECHNIC ANG. BEAM 4X2 90 DEG - Dark Stone Grey	2 x  4210753 TECHNIC ANG. BEAM 3X5 90 DEG. - Dark Stone Grey
2 x  4210980 TECHNIC LEVER 2M - Dark Stone Grey	2 x  4211573 1/2 BUSH - Medium Stone Grey	8 x  278026 CONNECTOR PEG W. FRICTION - Black
2 x  4225927 CONNECTOR PEG/CROSS AXLE - Bright Blue	3 x  655826 CONNECTOR PEG W. FRICTION 3M - Black	2 x  4210669 CATCH W. CROSS HOLE - Dark Stone Grey
2 x  370626 CROSS AXLE 6M - Black	2 x  370726 CROSS AXLE 8M - Black	1 x  373726 CROSS AXLE 10M - Black

