

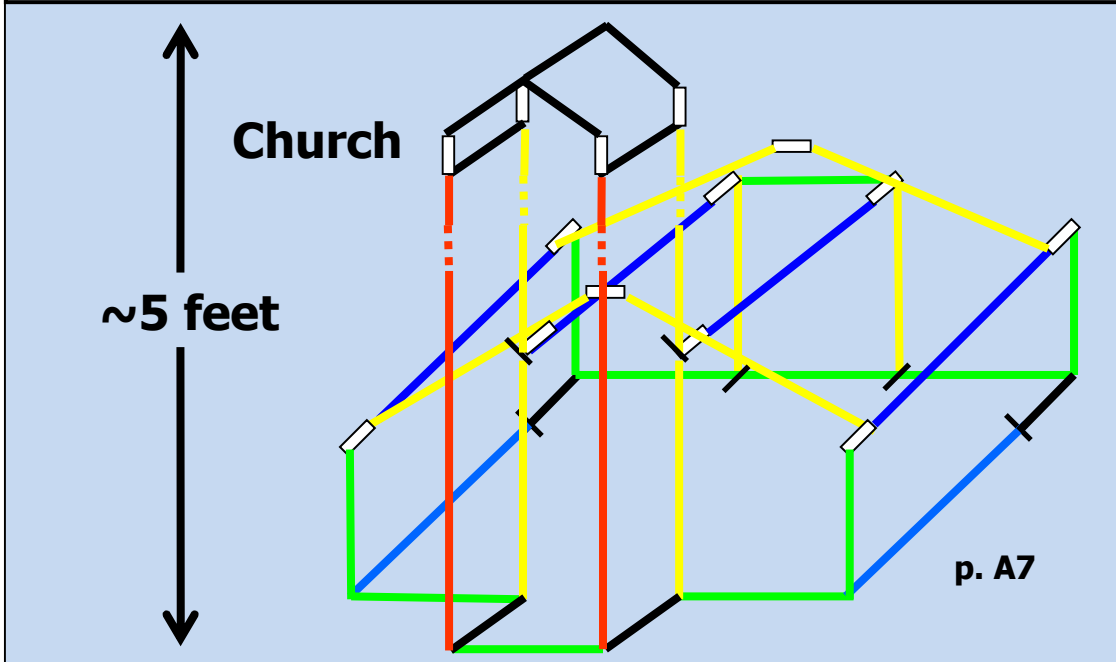

Kid-Size Construction Kit from PVC Pipe – Add'ns

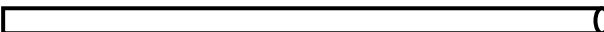

Standard Kit Parts:

#4s (Red)  (6X)

#3s (Blue)  (8X)

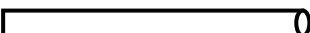
#2s (Yellow)  (12X)

#1s (Green)  (14X)

Is  (10X) Ls  (4X) Ts  (10X) Ys  (12X)

Additional Kit Parts:

#1/2s (Black)  (12X)

#pegs (White)  (14X)

Vs  (10X) Ts  (2X, additional ones)

Difficulty Ratings:

 = Easy

 = Medium

 = Hard

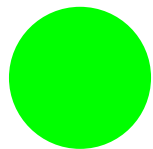

Box 7 (Small)



Parts

- 0 #4-pipes (Red)
- 0 #3-pipes (Blue)
- 0 #2-pipes (Yellow)
- 8 #1-pipes (Green)
- 4 #1/2 -pipes (Bk)
- 0 I-joiners
- 0 L-joiners
- 0 T-joiners
- 8 Y-joiners
- 0 V-joiners
- 0 pegs (White)

1

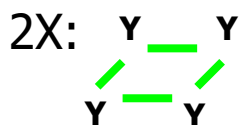

2



3



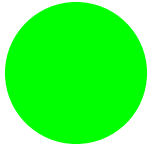

Box 8

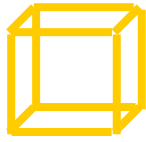

Parts

- 0 #4-pipes (Red)
- 0 #3-pipes (Blue)
- 12 #2-pipes (Yellow)
- 0 #1-pipes (Green)
- 0 #1/2 -pipes (Bk)
- 0 I-joiners
- 0 L-joiners
- 0 T-joiners
- 8 Y-joiners
- 0 V-joiners
- 0 pegs (White)

1

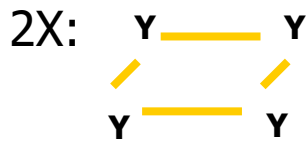

2



3



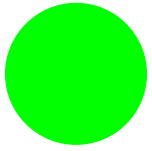

Box 9

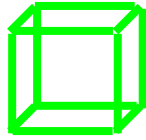

Parts

- 0 #4-pipes (Red)
- 0 #3-pipes (Blue)
- 0 #2-pipes (Yellow)
- 12 #1-pipes (Green)
- 0 #1/2 -pipes (Bk)
- 0 I-joiners
- 0 L-joiners
- 0 T-joiners
- 8 Y-joiners
- 0 V-joiners
- 0 pegs (White)

1

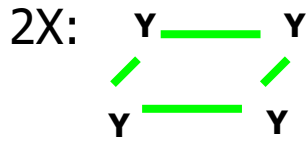

2

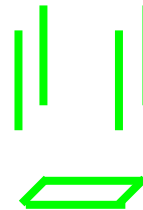

3





Box 10 (Big!)

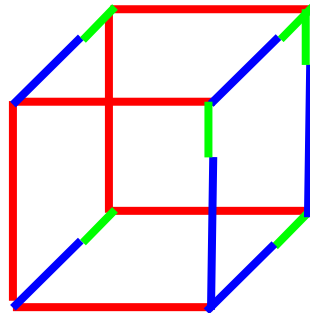

Parts

- 6 #4-pipes (Red)
- 6 #3-pipes (Blue)
- 0 #2-pipes (Yellow)
- 6 #1-pipes (Green)
- 0 #1/2 -pipes (Bk)
- 6 I-joiners
- 0 L-joiners
- 0 T-joiners
- 8 Y-joiners
- 0 V-joiners
- 0 pegs (White)

1

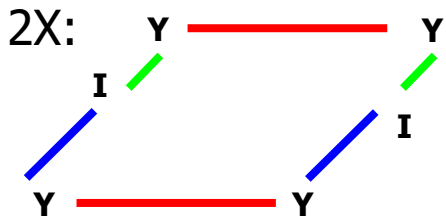

2

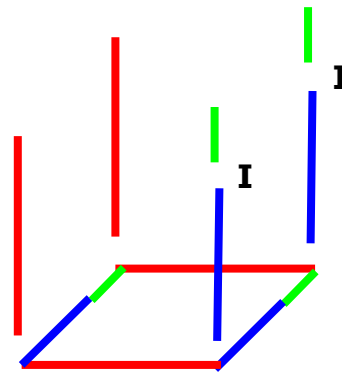

3

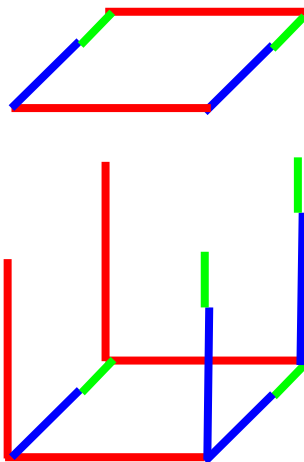



House 6

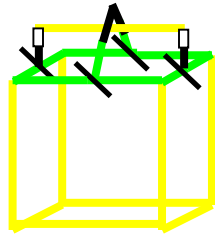

Parts

- 0 #4-pipes (Red)
- 0 #3-pipes (Blue)
- 9 #2-pipes (Yellow)
- 10 #1-pipes (Green)
- 4 #1/2 -pipes (Bk)
- 4 I-joiners
- 3 L-joiners
- 4 T-joiners
- 8 Y-joiners
- 0 V-joiners
- 2 pegs (White)

1

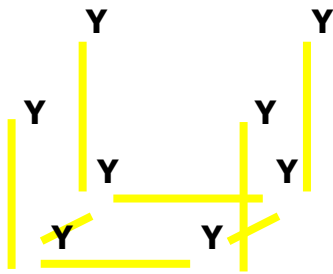

2

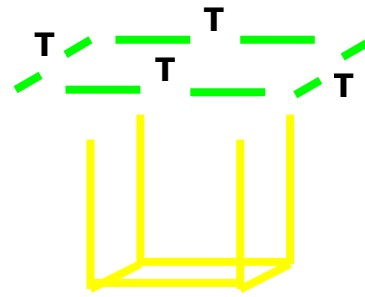

3

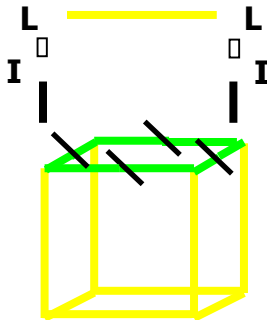

4

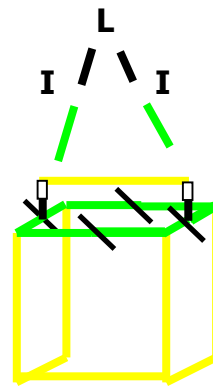



Church

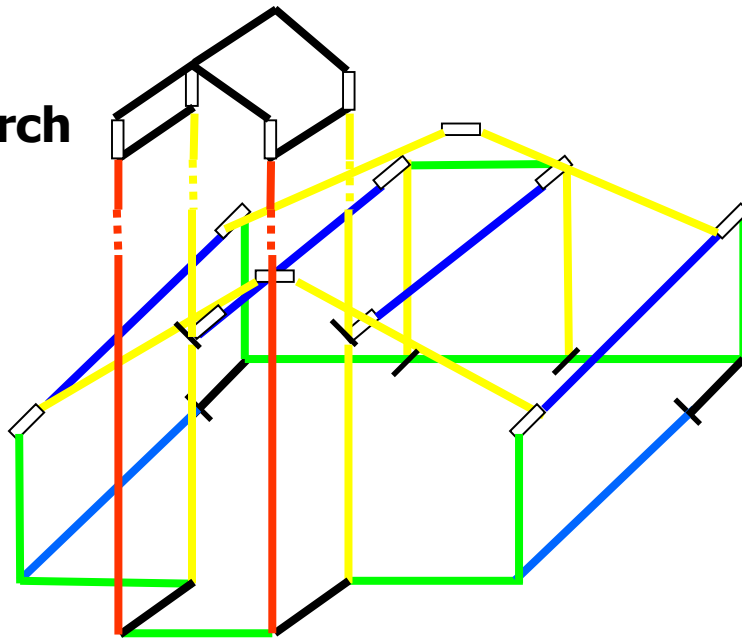

Parts

- 2 #4-pipes (Red)
- 6 #3-pipes (Blue)
- 10 #2-pipes (Yellow)
- 11 #1 pipes (Green)
- 11 #1/2 pipes (Black)
- 6 I-joiners
- 4 L-joiners
- 12 T-joiners
- 12 Y-joiners
- 8 V-joiners
- 14 pegs (White)

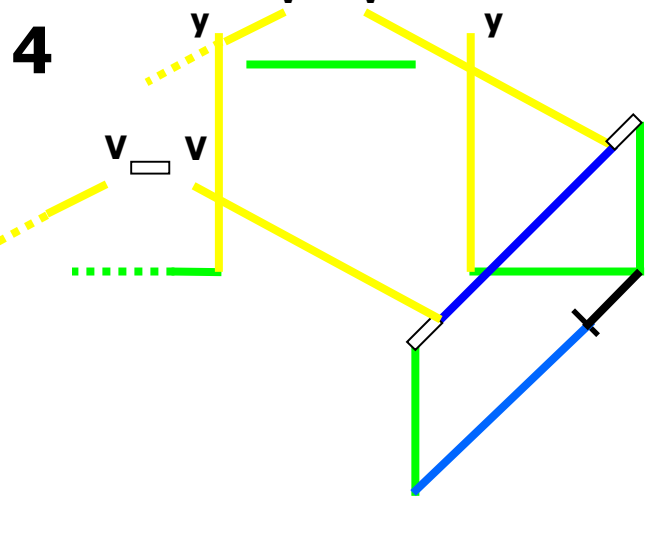
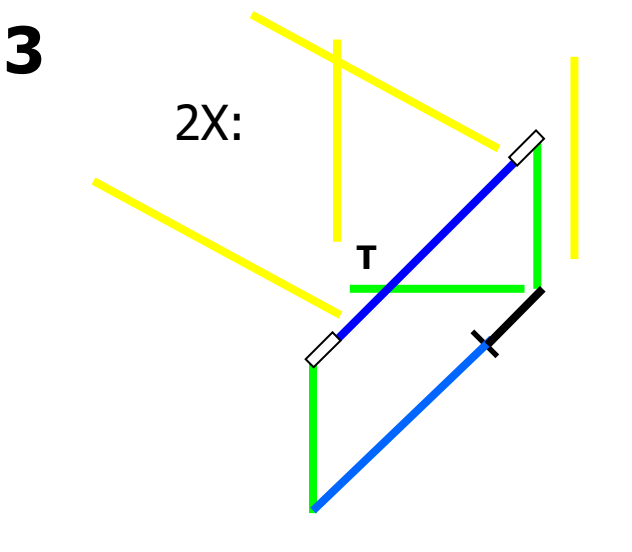
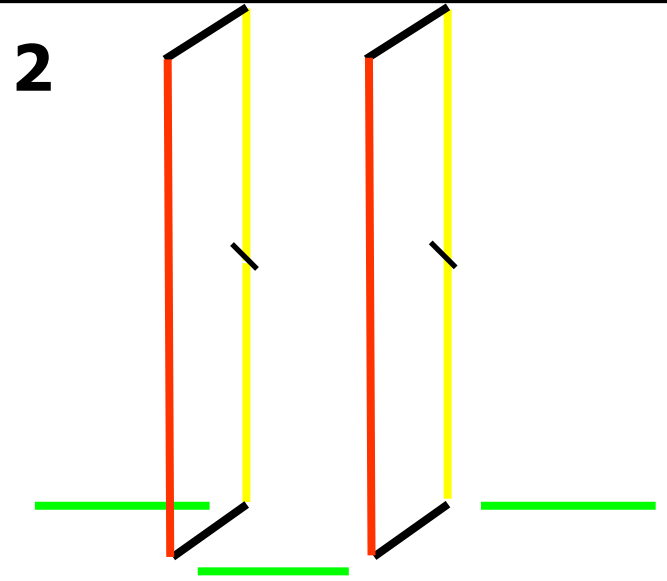
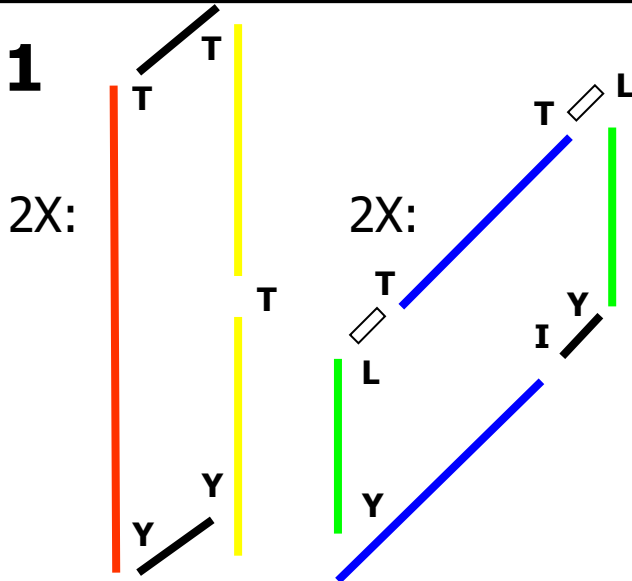

(continued)



Tent 1

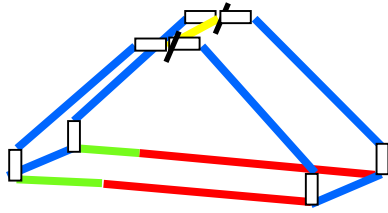

Parts

- 2 #4-pipes (Red)
- 6 #3-pipes (Blue)
- 1 #2-pipe (Yellow)
- 2 #1-pipes (Green)
- 0 #1/2 -pipes (Bk)
- 2 I-joiners
- 0 L-joiners
- 2 T-joiners
- 4 Y-joiners
- 8 V-joiners
- 8 pegs (White)

1

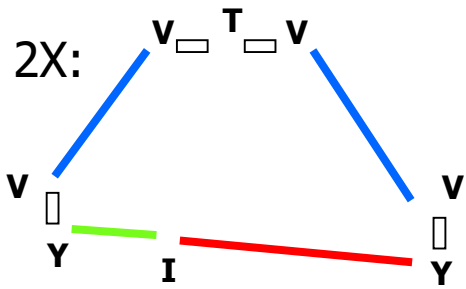

2

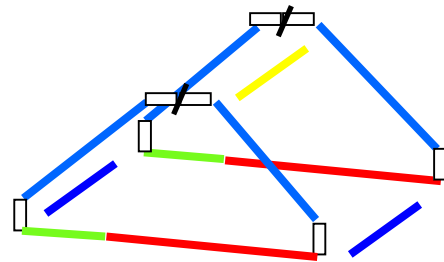



Tent 2

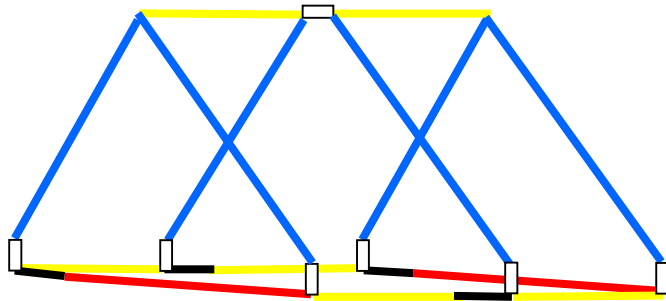

Parts

- 2 #4-pipes (Red)
- 6 #3-pipes (Blue)
- 6 #2-pipes (Yellow)
- 0 #1-pipes (Green)
- 4 #1/2 -pipes (Bk)
- 4 I-joiners
- 0 L-joiners
- 4 T-joiners
- 8 Y-joiners
- 6 V-joiners
- 7 pegs (White)

1

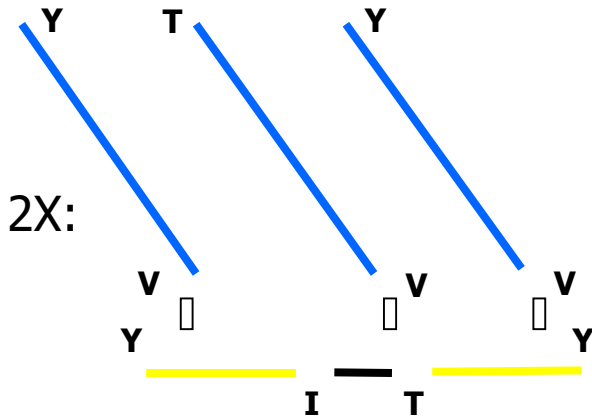

2

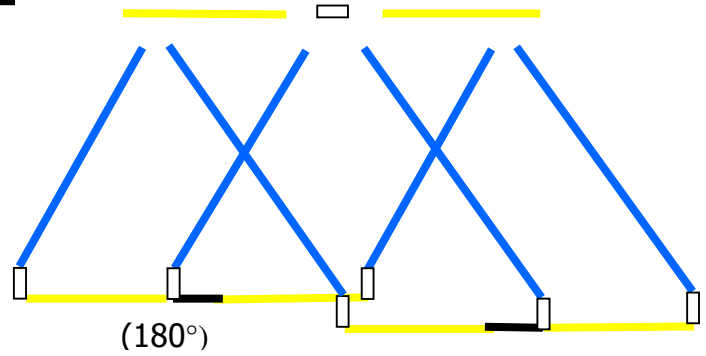

3

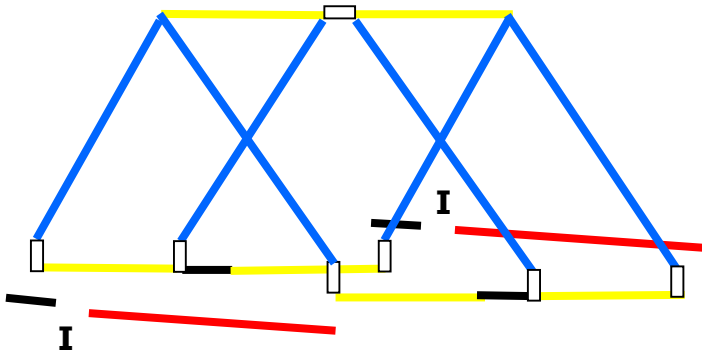

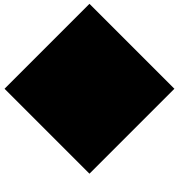

Race car

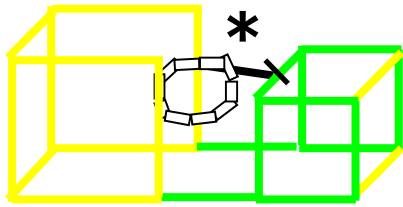

* Steering Wheel 1 or 2

Parts

- 0 #4-pipes (Red)
- 0 #3-pipes (Blue)
- 12 #2-pipes (Yellow)
- 12 #1-pipes (Green)
- 1 #1/2 -pipes (Bk)
- 1 I-joiners (+st. wh. 1)
- 2 L-joiners
- 6 T-joiners (+st. wh. 1)
- 10 Y-joiners
- 8 V-joiners (+st. wh. 1)
- 10 pegs (Wh) (+st.wh.1)

1

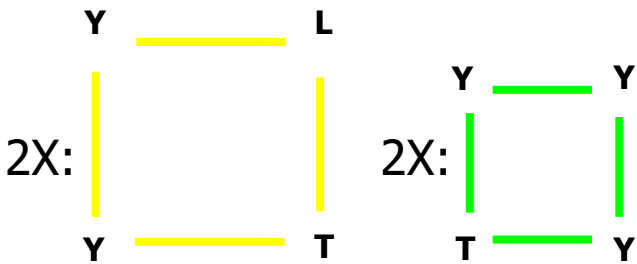

2

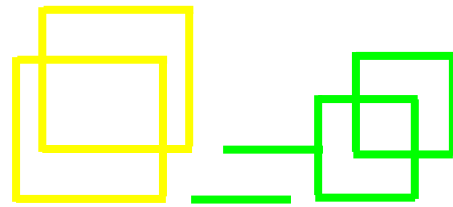

3

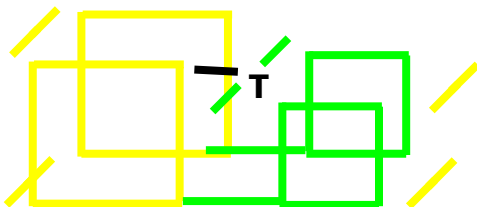

4

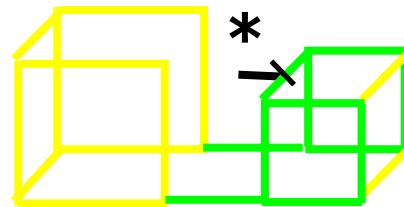

* Add Steering Wheel 1 or 2



Steering Wheel 1

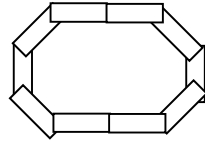

Parts

- 0 #4-pipes (**Red**)
- 0 #3-pipes (**Blue**)
- 0 #2-pipes (**Yellow**)
- 0 #1-pipes (**Green**)
- 0 #1/2 -pipes (**Bk**)
- 1 I-joiners
- 0 L-joiners
- 1 T-joiners (1 steer. wh. 1)
- 0 Y-joiners
- 8 V-joiners (steer. wh. 1)
- 10 pegs (**White**) (steer. wh. 1)

1

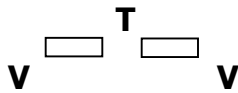

2

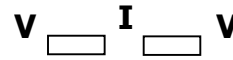

3

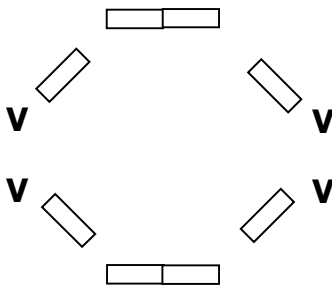

4

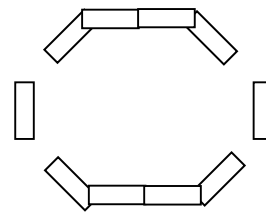

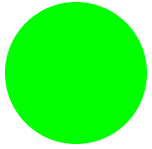

Steering Wheel 2

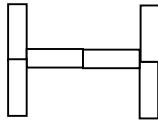

Parts

- 0 #4-pipes (Red)
- 0 #3-pipes (Blue)
- 0 #2-pipes (Yellow)
- 0 #1-pipes (Green)
- 0 #1/2 -pipes (Bk)
- 0 I-joiners
- 0 L-joiners
- 3 T-joiners
- 0 Y-joiners
- 4 V-joiners
- 6 pegs (White)

1



2

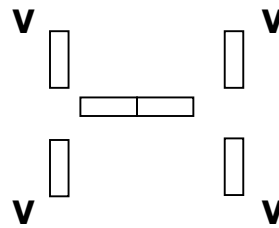



Prop Plane

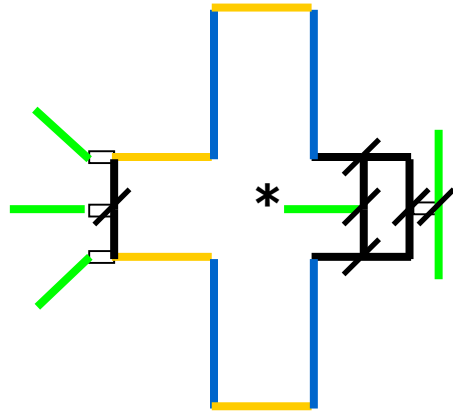

* Add Steering Wheel 2

Parts

- 0 #4-pipes (Red)
- 4 #3-pipes (Blue)
- 4 #2-pipes (Yellow)
- 6 #1-pipes (Green)
- 10 #1/2 -pipes (Bk)
- 0 I-joiners
- 4 L-joiners
- 9 T-joiners (+st. wh. 2)
- 8 Y-joiners
- 7 V-joiners (+st. wh. 2)
- 10 pegs (Wh) (+st. wh. 2)

1

2X:
 Y Y (s.i.c.) L T L

2

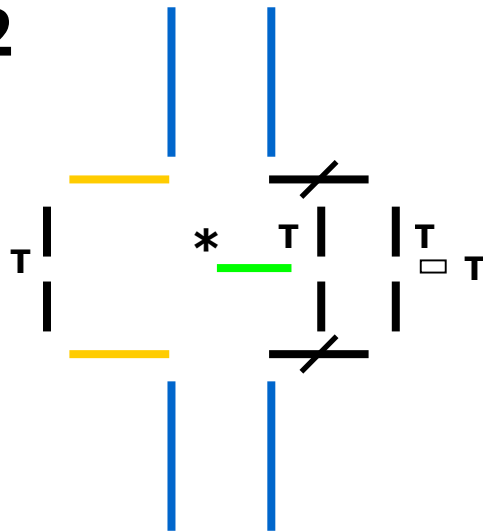

3

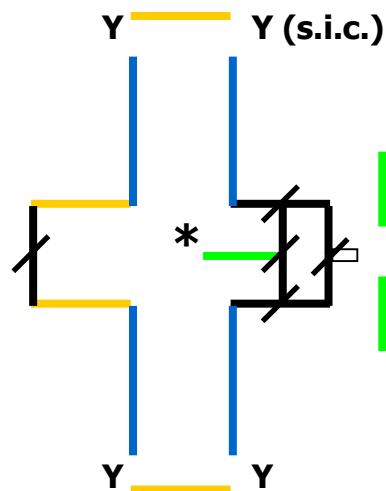

* Add Steering Wheel 2

4

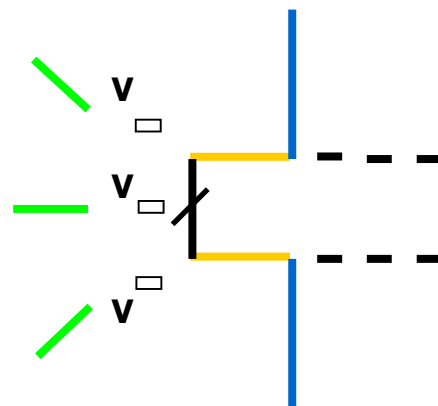

Jet Plane

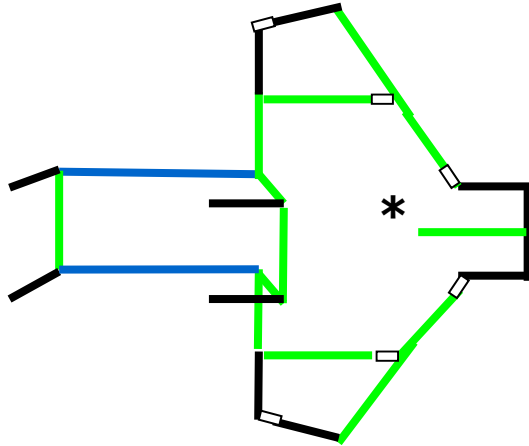
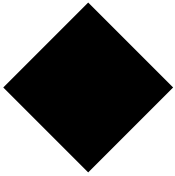

* Add Steering Wheel 2

Parts

- 0 #4-pipes (Red)
- 2 #3-pipes (Blue)
- 0 #2-pipes (Yellow)
- 13 #1-pipes (Green)
- 12 #1/2 -pipes (Bk)
- 8 I-joiners
- 4 L-joiners
- 8 T-joiners (+st. wh. 2)
- 6 Y-joiners
- 10 V-joiners (+st. wh. 2)
- 14 pegs (Wh) (+st. wh. 2)

1

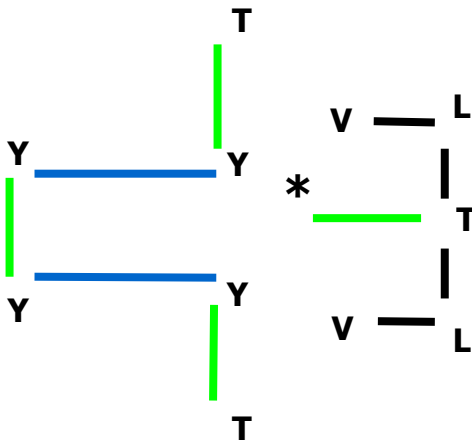

* Add Steering Wheel 2

2

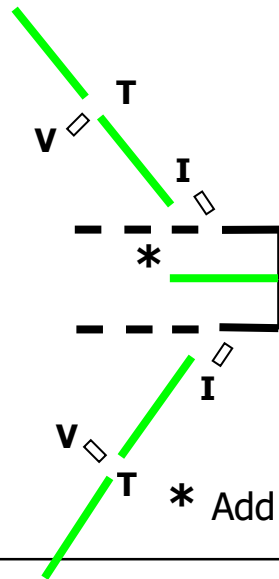

* Add Steering Wheel 2

3

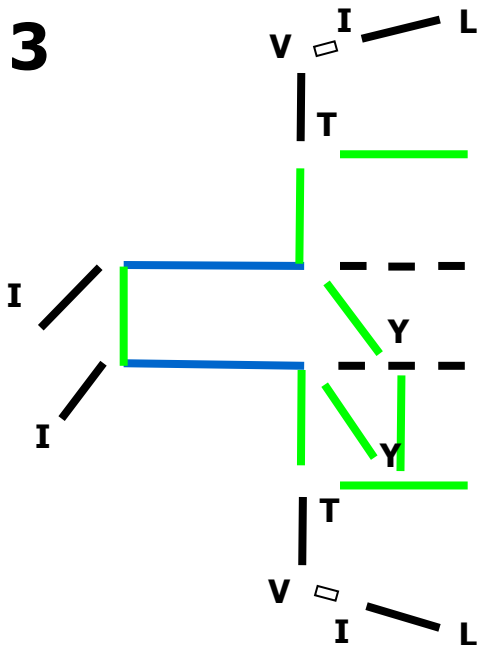

4

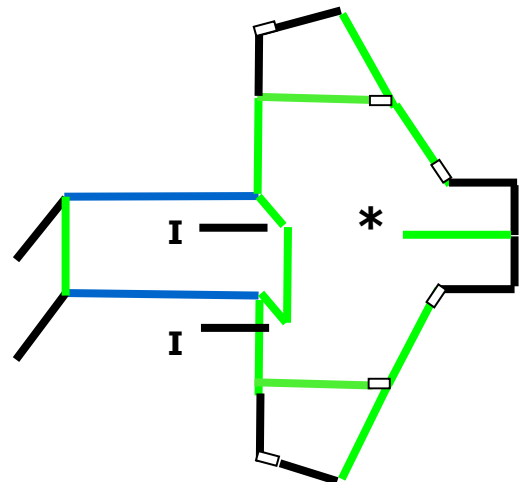

* Add Steering Wheel 2

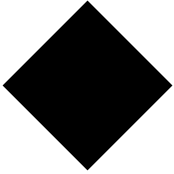

Star Wars® X-Wing Fighter

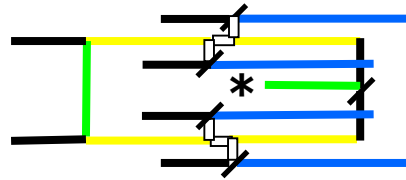

* Add Steering Wheel 2

Parts

- 0 #4-pipes (**Red**)
- 4 #3-pipes (**Blue**)
- 4 #2-pipes (**Yellow**)
- 2 #1-pipes (**Green**)
- 8 #1/2 -pipes (**Black**)
- 6 I-joiners
- 2 L-joiners
- 12 T-joiners (+ steer. wh. 2)
- 6 Y-joiners
- 4 V-joiners (+ steer. wh. 2)
- 12 pegs (**White**) (+ st.wh.2)

1

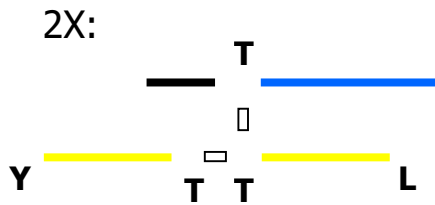

2

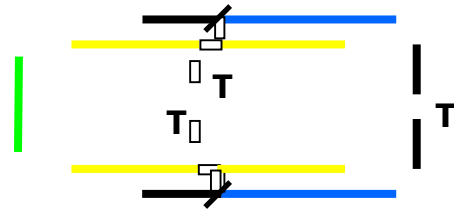

3

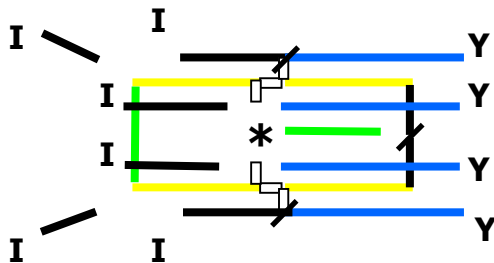

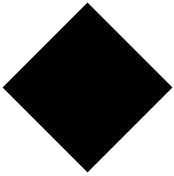

Star Wars® Tie Fighter

Parts

- 0 #4-pipes (Red)
- 0 #3-pipes (Blue)
- 8 #2-pipes (Yellow)
- 12 #1-pipes (Green)
- 4 #1/2 -pipes (Black)
- 4 I-joiners
- 4 L-joiners
- 8 T-joiners (+ st. wh. 2)
- 8 Y-joiners
- 4 V-joiners (+ st. wh. 2)
- 12 pegs (White) (+ st.wh.2)

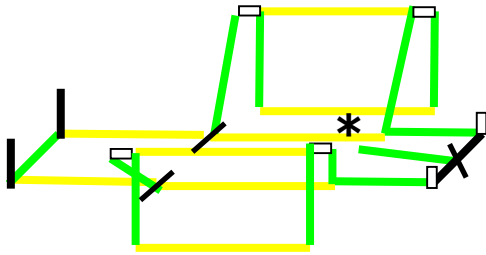

* Add Steering Wheel 2

1



2

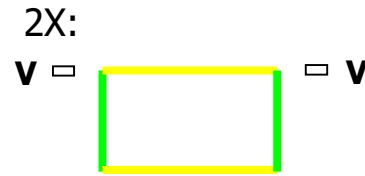
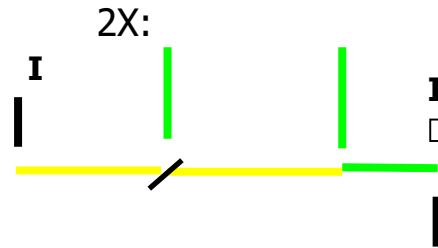

3

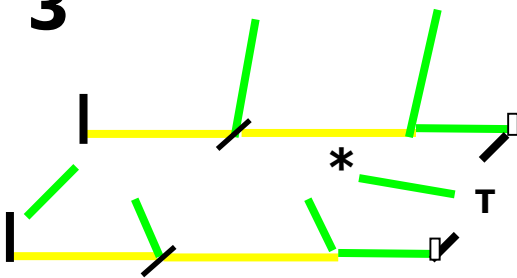

4

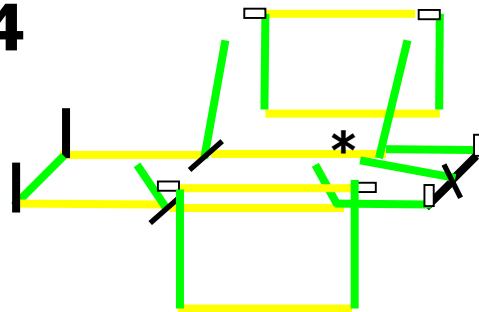



Star Wars® Millenium Falcon

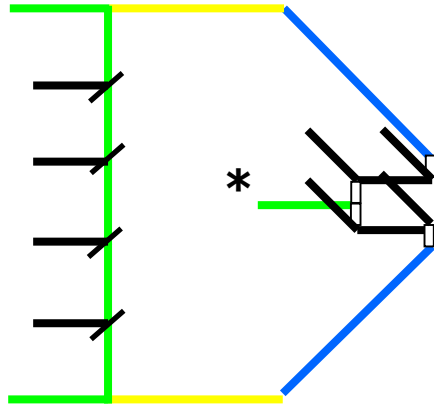

* Add Steering Wheel 2

Parts

- 0 #4-pipes (**Red**)
- 2 #3-pipes (**Blue**)
- 2 #2-pipes (**Yellow**)
- 8 #1-pipes (**Green**)
- 10 #1/2 -pipes (**Black**)
- 10 I-joiners
- 0 L-joiners
- 10 T-joiners (+ st. wh. 2)
- 4 Y-joiners
- 8 V-joiners (+ st. wh. 2)
- 10 pegs (**White**) (+ st.wh.2)

1

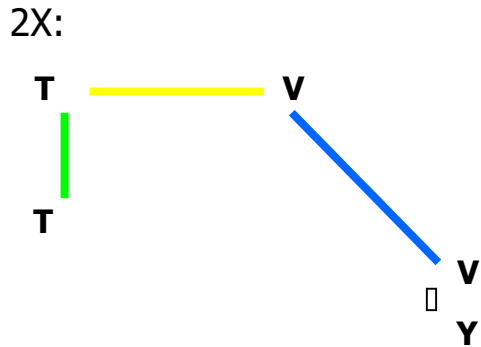

2

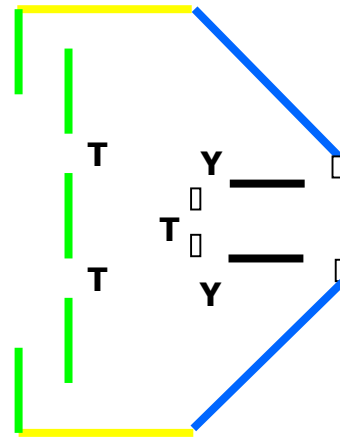

3

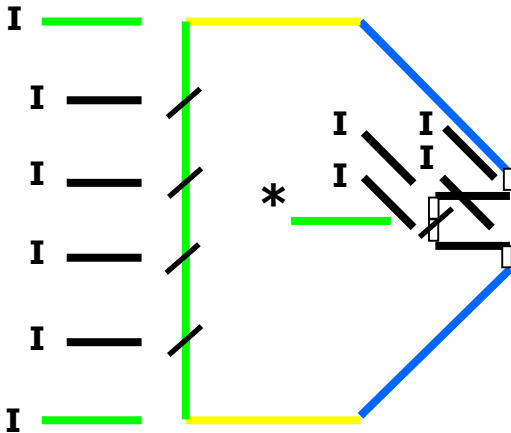



Teddy Bear Slide

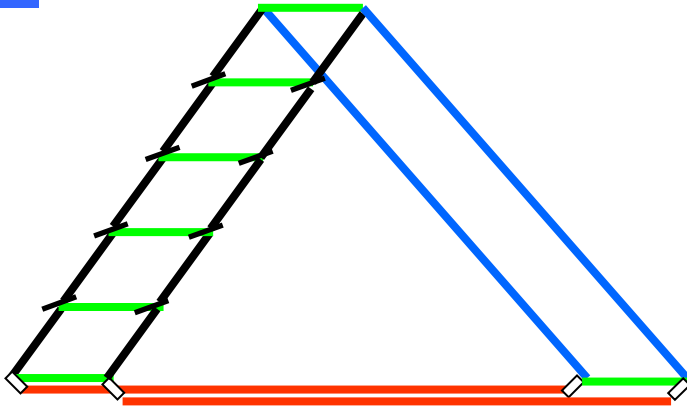

Parts

- 2 #4-pipes (Red)
- 2 #3-pipes (Blue)
- 0 #2-pipes (Yellow)
- 7 #1-pipes (Green)
- 10 #1/2 -pipes (Black)
- 0 I-joiners
- 0 L-joiners
- 8 T-joiners
- 6 Y-joiners
- 4 V-joiners
- 4 pegs (White)

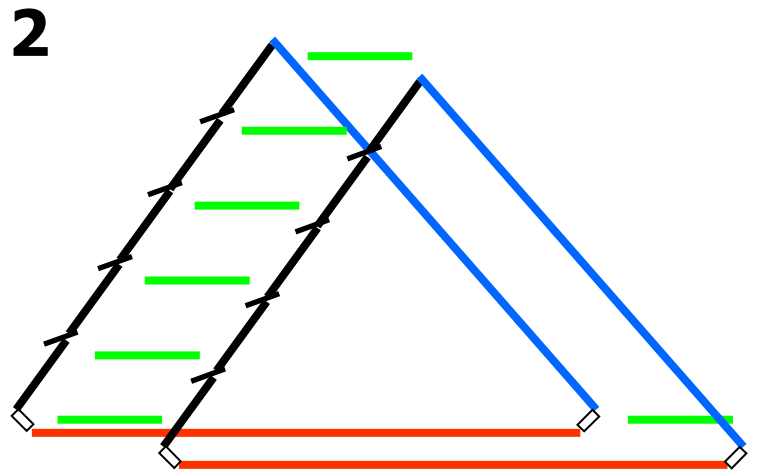
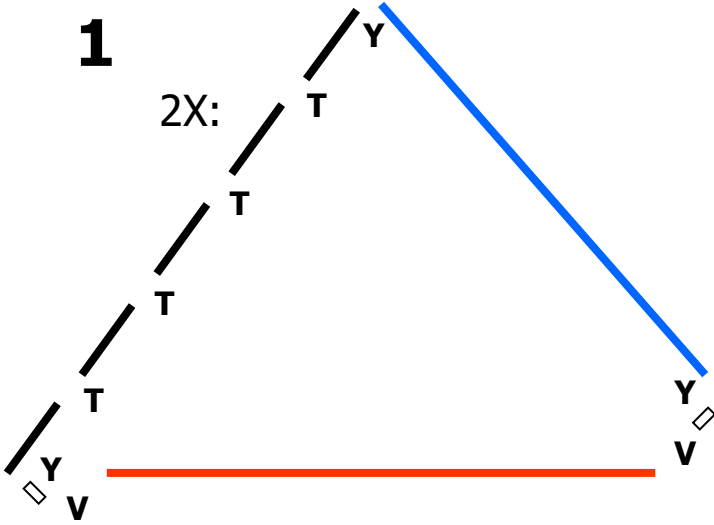



Teddy Bear Swing

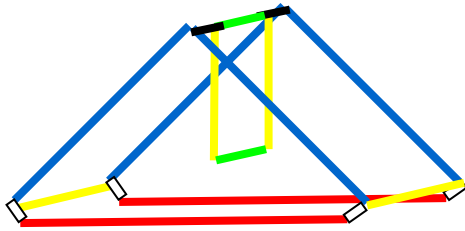

Parts

- 2 #4-pipes (Red)
- 4 #3-pipes (Blue)
- 4 #2-pipes (Yellow)
- 2 #1-pipes (Green)
- 2 #1/2 -pipes (Black)
- 0 I-joiners
- 2 L-joiners
- 2 T-joiners
- 6 Y-joiners
- 4 V-joiners
- 4 pegs (White)

1

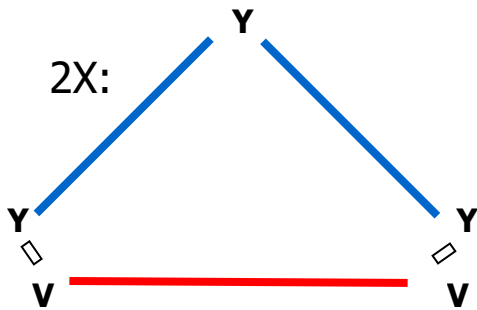

2

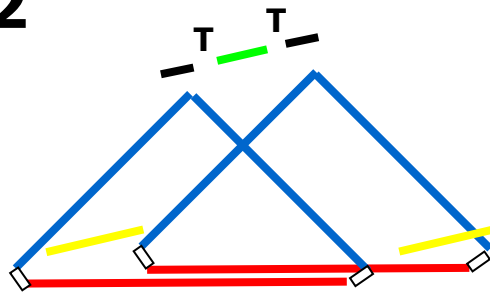

3

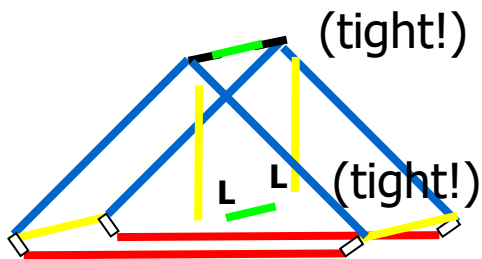

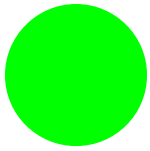

Teddy Bear Merry-go-round

Parts

- 0 #4-pipes **(Red)**
- 0 #3-pipes **(Blue)**
- 1 #2-pipes **(Yellow)**
- 6 #1-pipes **(Green)**
- 7 #1/2 -pipes **(Black)**
- 1 I-joiners
- 2 L-joiners
- 2 T-joiners
- 0 Y-joiners
- 8 V-joiners
- 0 pegs **(White)**

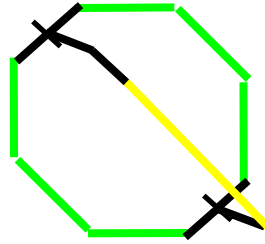

1

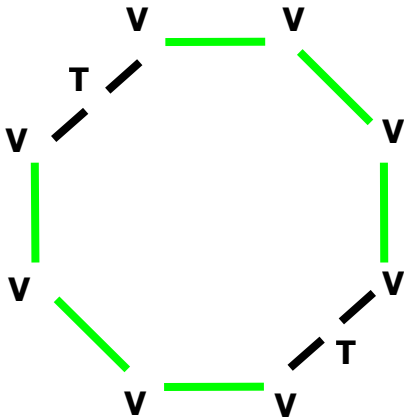

2

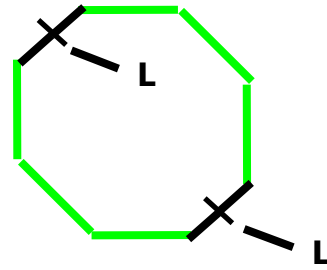

3

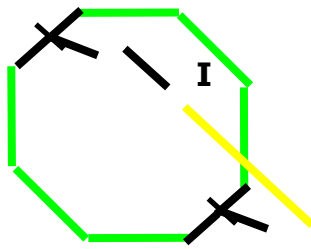

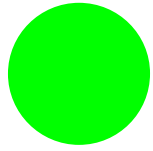

Pistol/Ray Gun

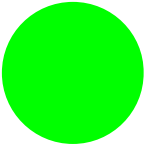

Parts

- 0 #4-pipes **(Red)** A22
- 0 #3-pipes **(Blue)**
- 0 #2-pipes **(Yellow)**
- 0 #1-pipes **(Green)**
- 1 #1/2 -pipes **(Bk)**
- 3 I-joiners
- 0 L-joiners
- 1 T-joiners
- 0 Y-joiners
- 0 V-joiners
- 2 pegs **(White)**

1

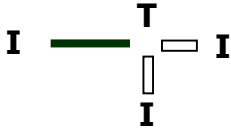

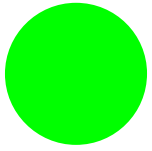

Rifle/Blaster

Parts

- 0 #4-pipes (Red)
- 0 #3-pipes (Blue)
- 0 #2-pipes (Yellow)
- 0 #1-pipes (Green)
- 3 #1/2 -pipes (Bk)
- 2 I-joiners
- 3 L-joiners
- 2 T-joiners
- 0 Y-joiners
- 0 V-joiners
- 4 pegs (White)

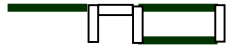

1



2



3

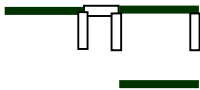

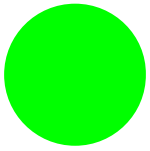

Uzi

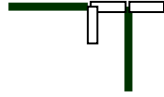

Parts

- 0 #4-pipes (Red)
- 0 #3-pipes (Blue)
- 0 #2-pipes (Yellow)
- 0 #1-pipes (Green)
- 2 #1/2 -pipes (Bk)
- 4 I-joiners
- 0 L-joiners
- 2 T-joiners
- 0 Y-joiners
- 0 V-joiners
- 3 pegs (White)

1

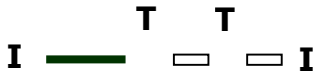

2

