

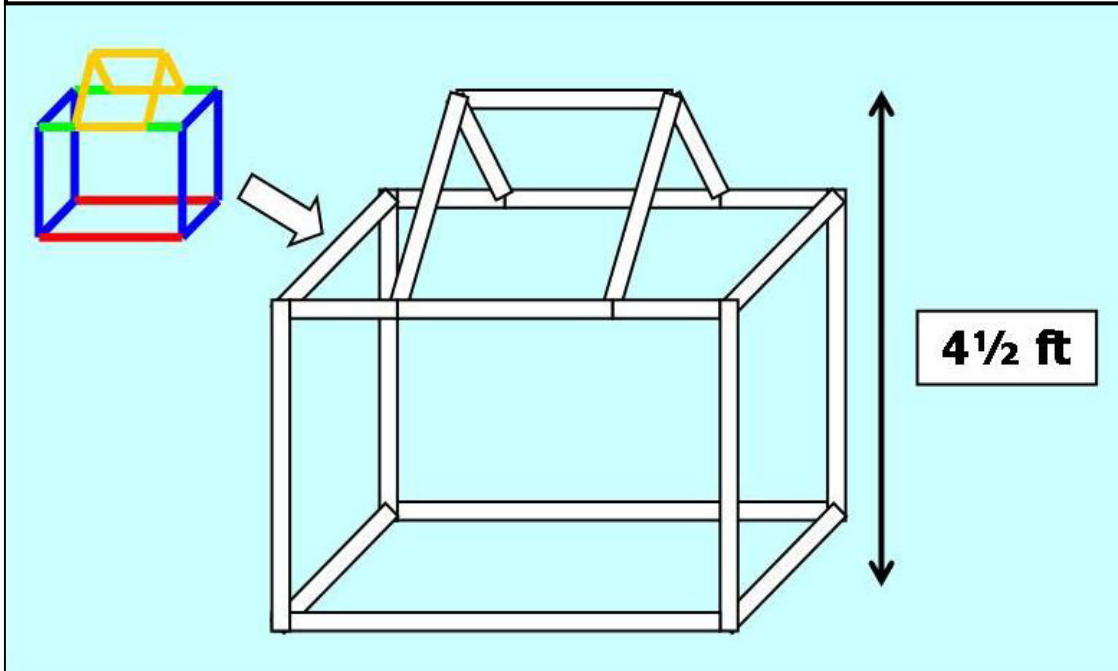



Kid-Size Construction Kit from PVC Pipe







Kit Parts:

#4s (Red)  (6X)

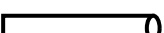
#3s (Blue)  (8X)

#2s (Yellow)  (12X)

#1s (Green)  (14X)

Is:  (10X) Ls:  (4X) Ts:  (10X) Ys:  (12X)

Difficulty Ratings:

 = Easy

 = Medium

 = Hard

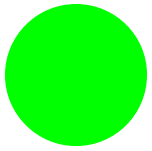

Box 1

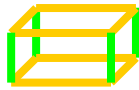

Parts

- 0 #4-pipes (Red)
- 0 #3-pipes (Blue)
- 8 #2-pipes (Yellow)
- 4 #1-pipes (Green)
- 0 I-joiners
- 0 L-joiners
- 0 T-joiners
- 8 Y-joiners

1

2X:



2

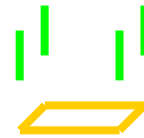

3

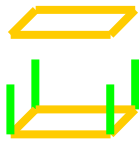

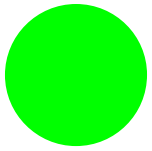

Box 2

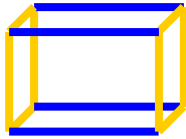

Parts

- 0 #4-pipes (Red)
- 4 #3-pipes (Blue)
- 8 #2-pipes (Yellow)
- 0 #1-pipes (Green)
- 0 I-joiners
- 0 L-joiners
- 0 T-joiners
- 8 Y-joiners

1

2X:

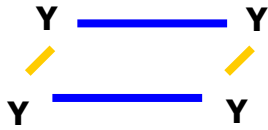

2

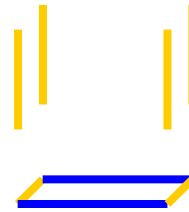

3

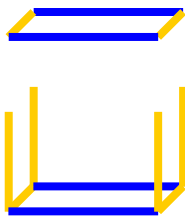

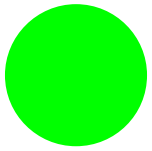

Box 3



Parts

- 4 #4-pipes (Red)
- 0 #3-pipes (Blue)
- 8 #2-pipes (Yellow)
- 0 #1-pipes (Green)
- 0 I-joiners
- 0 L-joiners
- 0 T-joiners
- 8 Y-joiners

1

2X:



2

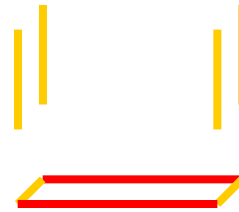

3

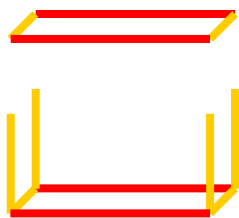

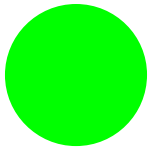

Box 4

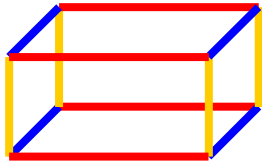

Parts

- 4 #4-pipes (Red)
- 4 #3-pipes (Blue)
- 4 #2-pipes (Yellow)
- 0 #1-pipes (Green)
- 0 I-joiners
- 0 L-joiners
- 0 T-joiners
- 8 Y-joiners

1

2X:



2

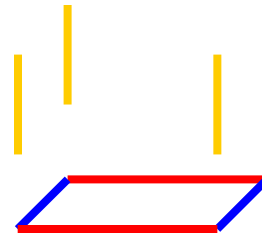

3

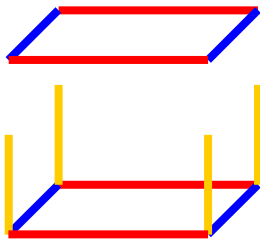

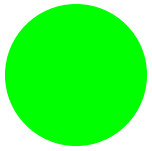

Box 5

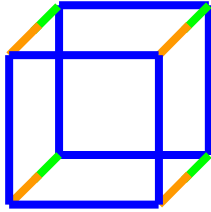

Parts

- 0 #4-pipes (Red)
- 8 #3-pipes (Blue)
- 4 #2-pipes (Yellow)
- 4 #1-pipes (Green)
- 4 I-joiners
- 0 L-joiners
- 0 T-joiners
- 8 Y-joiners

1

2X:

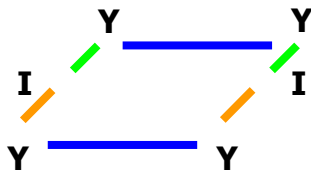

2

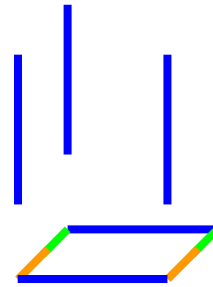

3

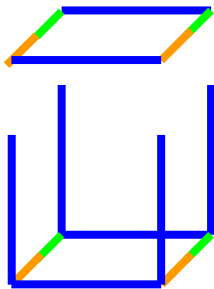

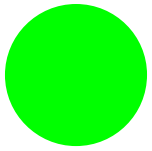

Box 6

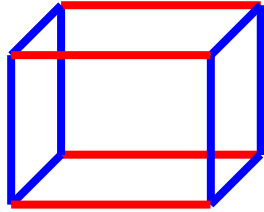

Parts

- 4 #4-pipes (Red)
- 8 #3-pipes (Blue)
- 0 #2-pipes (Yellow)
- 0 #1-pipes (Green)
- 0 I-joiners
- 0 L-joiners
- 0 T-joiners
- 8 Y-joiners

1

2X:



2

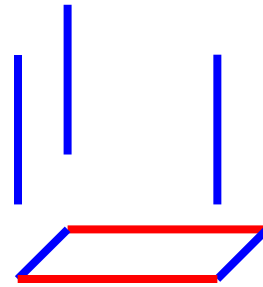

3

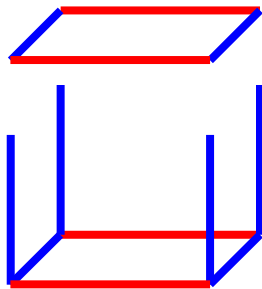



Tunnel 1

Parts

- 6 #4-pipes (Red)
- 8 #3-pipes (Blue)
- 12 #2-pipes (Yellow)
- 8 #1-pipes (Green)
- 10 I-joiners
- 0 L-joiners
- 8 T-joiners
- 8 Y-joiners

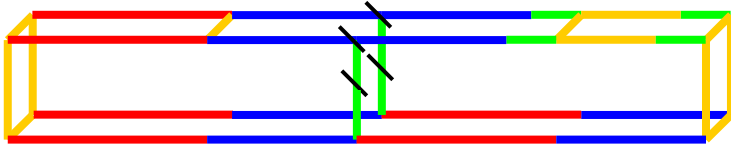

1

2

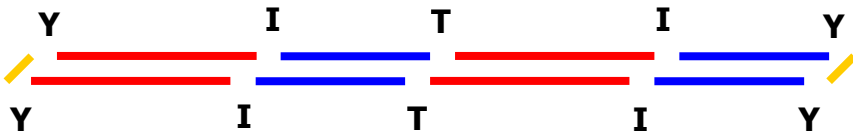
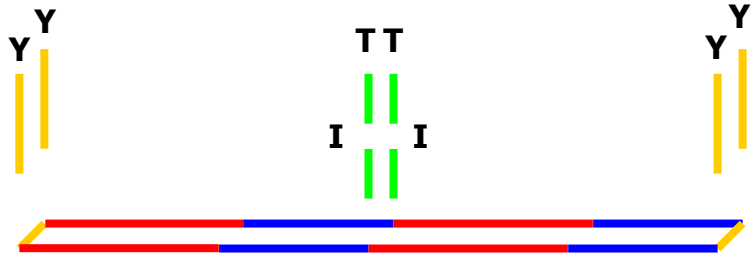

3

4

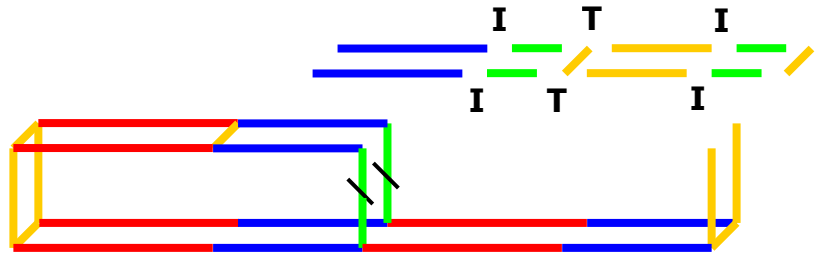
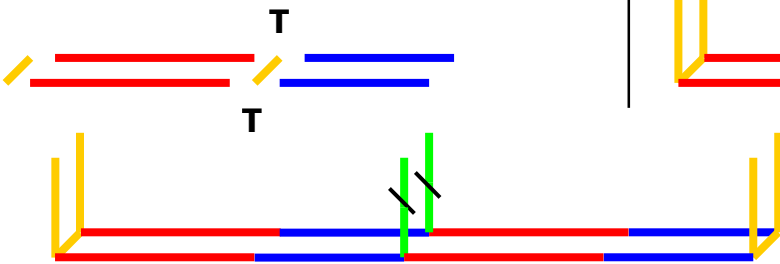



Tunnel 2

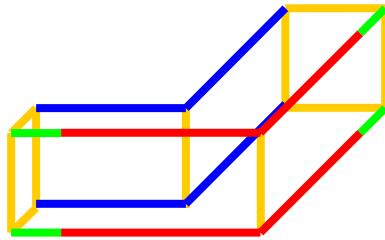

Parts

- 4 #4-pipes (Red)
- 4 #3-pipes (Blue)
- 10 #2-pipes (Yellow)
- 4 #1-pipes (Green)
- 4 I-joiners
- 0 L-joiners
- 0 T-joiners
- 12 Y-joiners

1

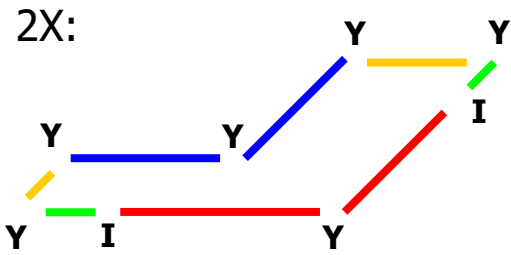

2

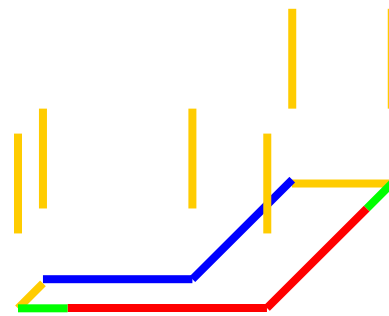

3

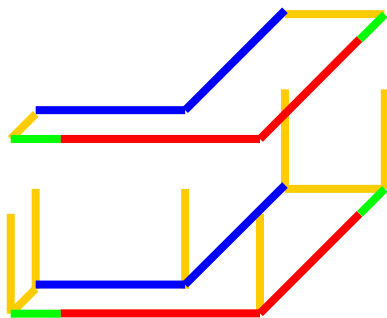



Tunnel 3

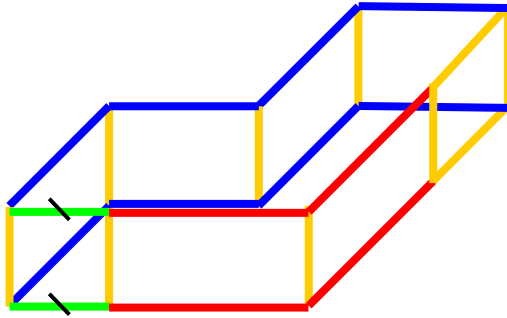

Parts

- 4 #4-pipes (Red)
- 8 #3-pipes (Blue)
- 10 #2-pipes (Yellow)
- 4 #1-pipes (Green)
- 2 I-joiners
- 0 L-joiners
- 4 T-joiners
- 12 Y-joiners

1

2X:

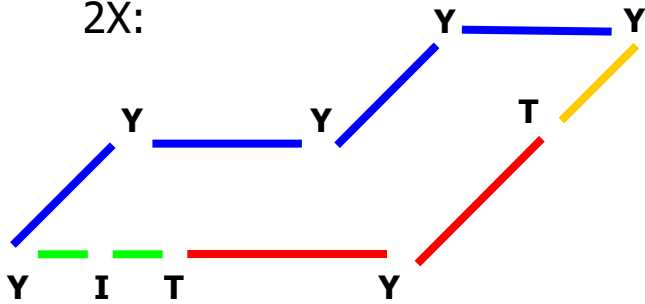

2

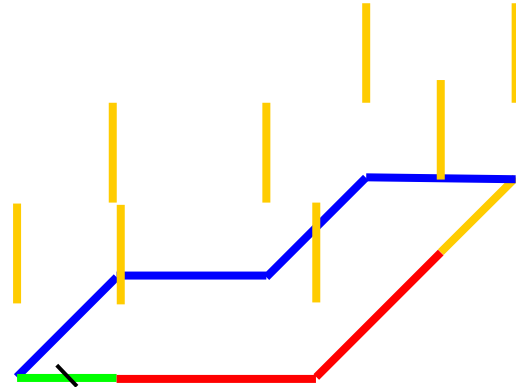

3

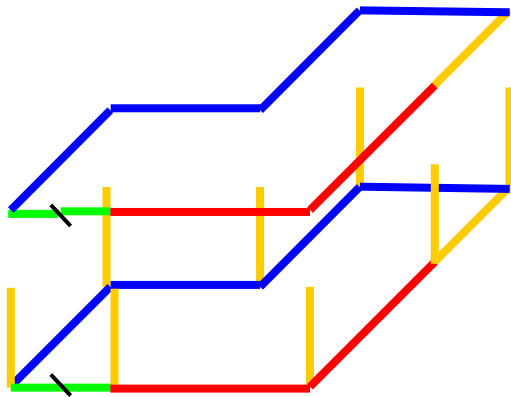



Tunnel 4

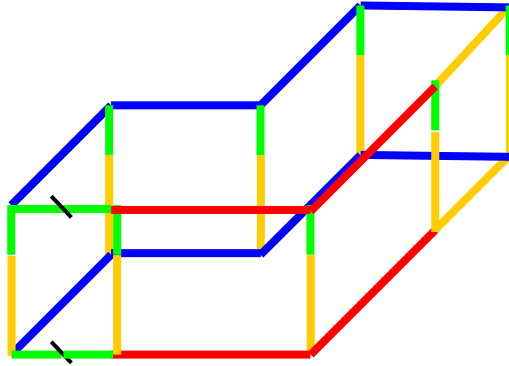

Parts

- 4 #4-pipes (Red)
- 8 #3-pipes (Blue)
- 10 #2-pipes (Yellow)
- 12 #1-pipes (Green)
- 10 I-joiners
- 0 L-joiners
- 4 T-joiners
- 12 Y-joiners

1

2X:

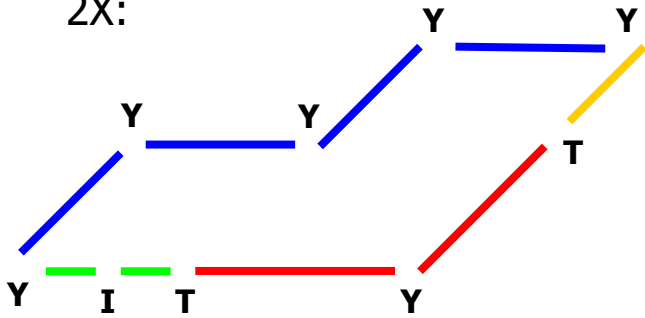

2

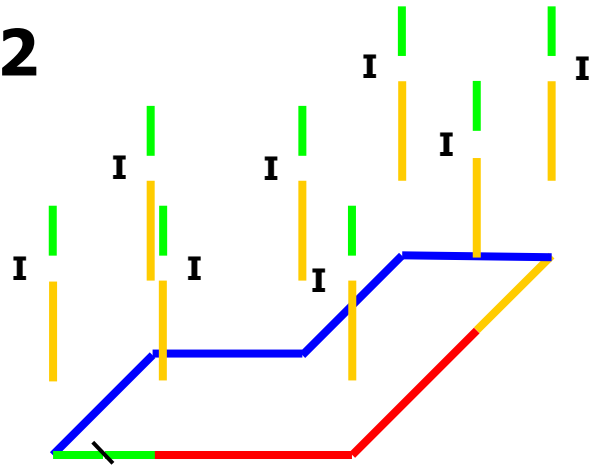

3

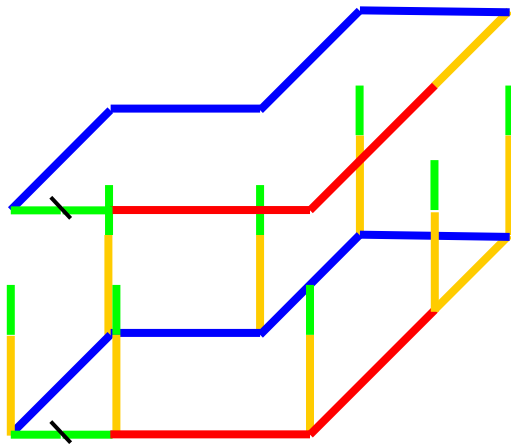



House 1

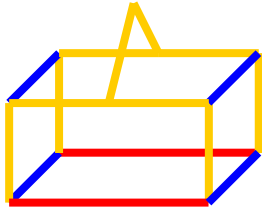

Parts

- 2 #4-pipes (Red)
- 4 #3-pipes (Blue)
- 10 #2-pipes (Yellow)
- 0 #1-pipes (Green)
- 0 I-joiners
- 1 L-joiners
- 2 T-joiners
- 8 Y-joiners

1



2

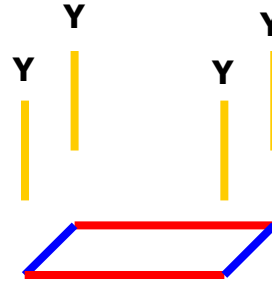

3

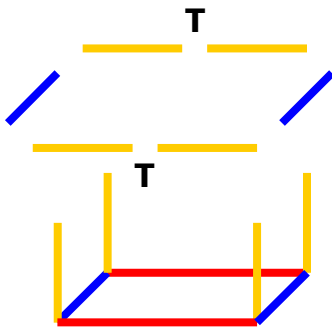

4

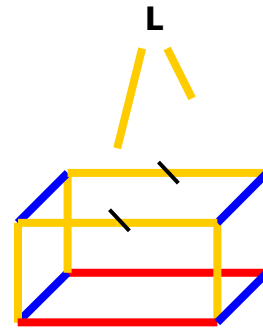



House 2

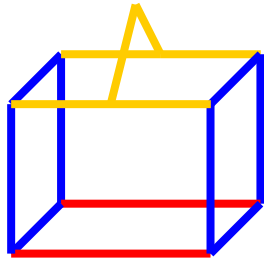

Parts

- 2 #4-pipes (Red)
- 8 #3-pipes (Blue)
- 6 #2-pipes (Yellow)
- 0 #1-pipes (Green)
- 0 I-joiners
- 1 L-joiners
- 2 T-joiners
- 8 Y-joiners

1



2

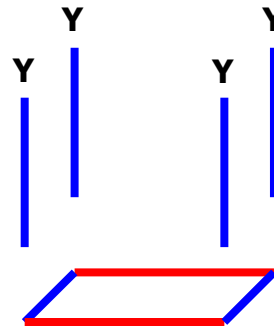

3

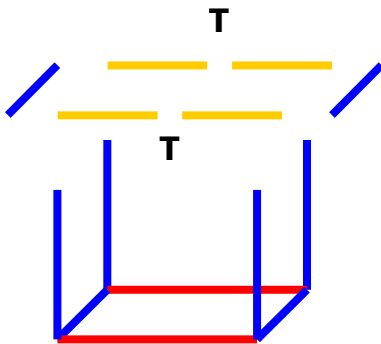

4

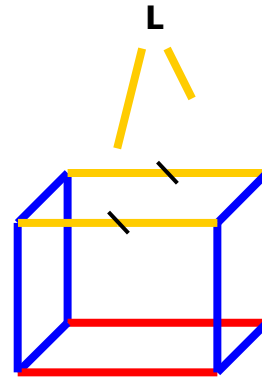



House 3

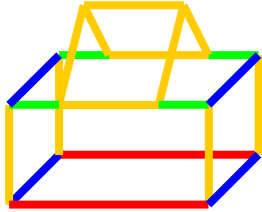

Parts

- 2 #4-pipes (Red)
- 4 #3-pipes (Blue)
- 11 #2-pipes (Yellow)
- 4 #1-pipes (Green)
- 0 I-joiners
- 0 L-joiners
- 4 T-joiners
- 10 Y-joiners

1



2

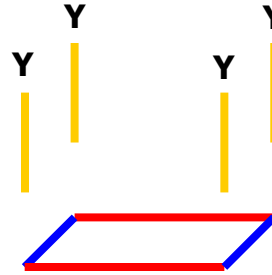

3

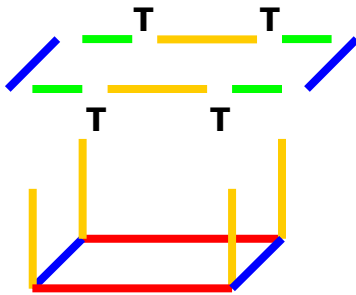

4

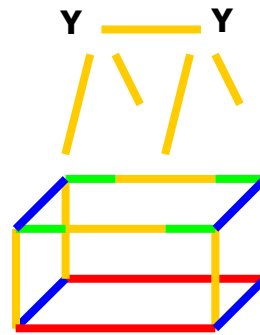



House 4 (the cover picture)

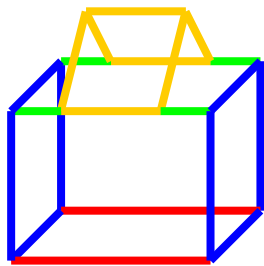

Parts

- 2 #4-pipes (Red)
- 8 #3-pipes (Blue)
- 7 #2-pipes (Yellow)
- 4 #1-pipes (Green)
- 0 I-joiners
- 0 L-joiners
- 4 T-joiners
- 10 Y-joiners

1

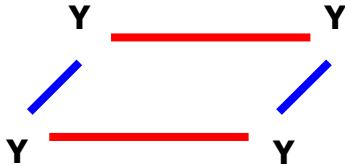

2

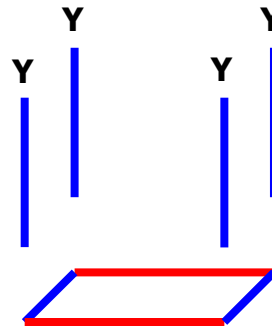

3

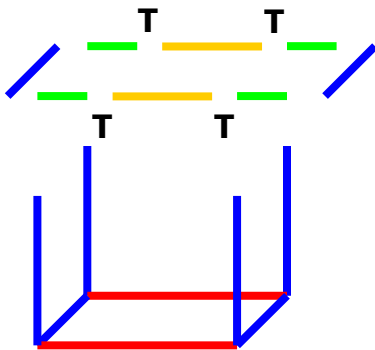

4

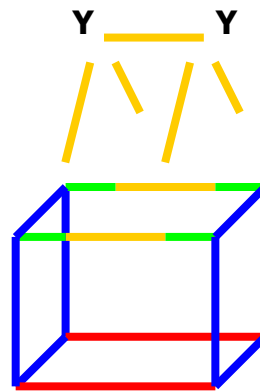



House 5

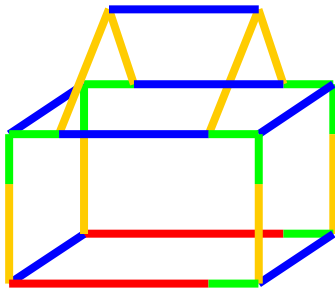

Parts

- 2 #4-pipes (Red)
- 7 #3-pipes (Blue)
- 8 #2-pipes (Yellow)
- 10 #1-pipes (Green)
- 6 I-joiners
- 0 L-joiners
- 4 T-joiners
- 10 Y-joiners

1

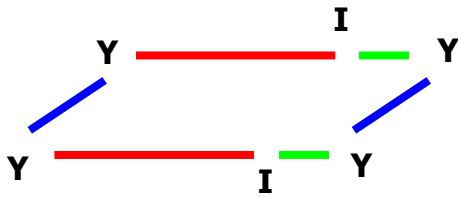

2

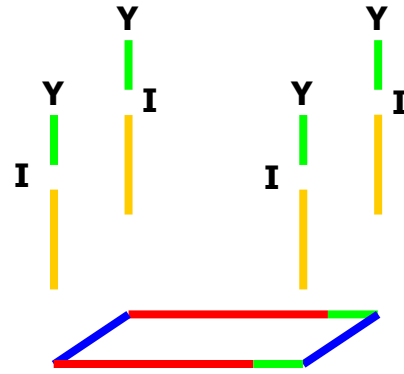

3

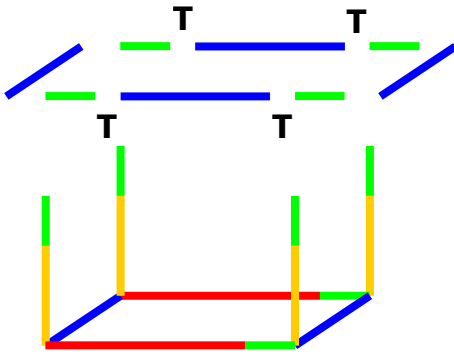

4

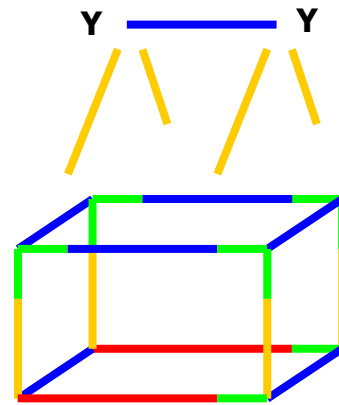

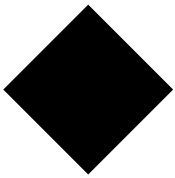

Long House

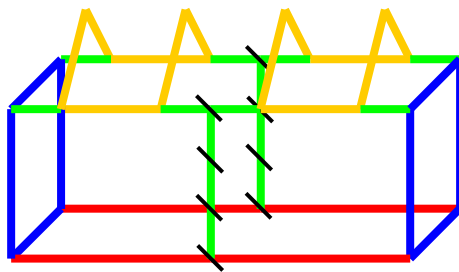

Parts

- 4 #4-pipes (Red)
- 8 #3-pipes (Blue)
- 12 #2-pipes (Yellow)
- 14 #1-pipes (Green)
- 4 I-joiners
- 4 L-joiners
- 12 T-joiners
- 8 Y-joiners

1

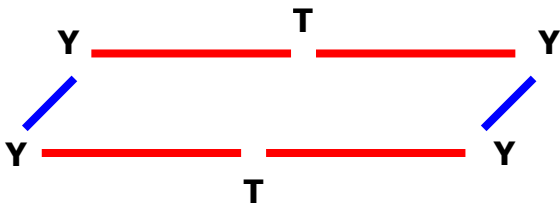

2

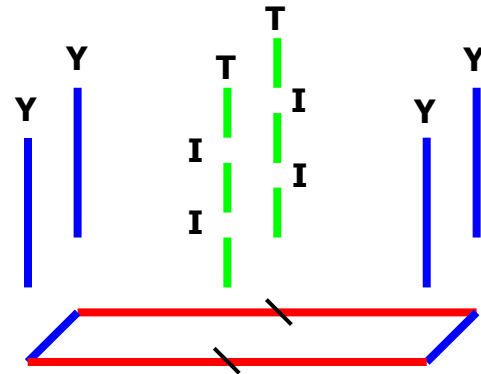

3

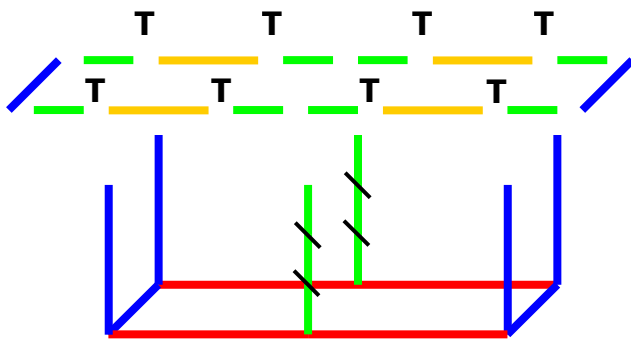

4

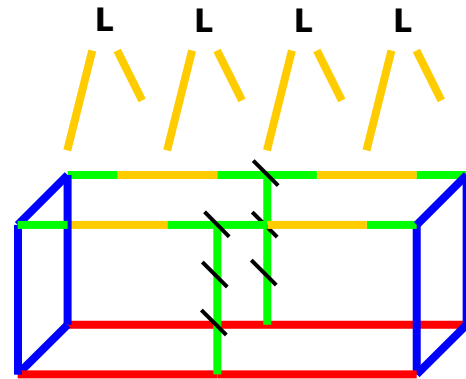

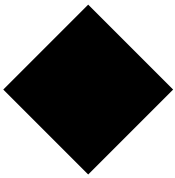

Modern House 1

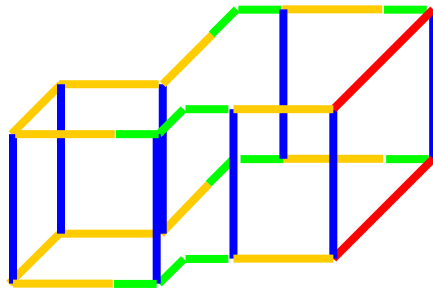

Parts

- 2 #4-pipes (Red)
- 8 #3-pipes (Blue)
- 12 #2-pipes (Yellow)
- 12 #1-pipes (Green)
- 6 I-joiners
- 4 L-joiners
- 4 T-joiners
- 12 Y-joiners

1

2X:

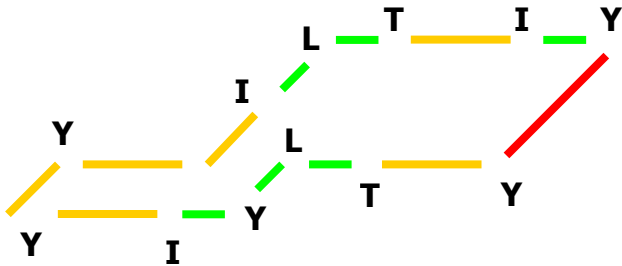

2

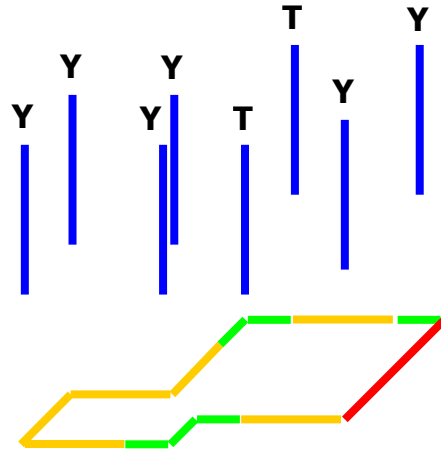

3

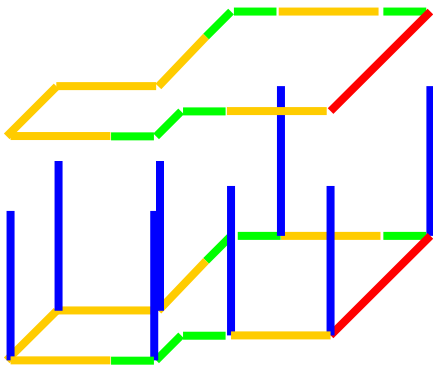

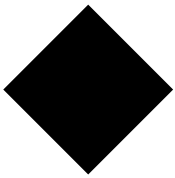

Modern House 2

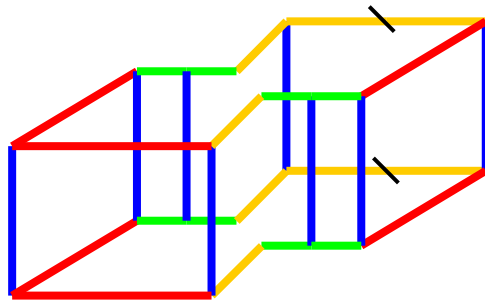

Parts

- 6 #4-pipes (Red)
- 8 #3-pipes (Blue)
- 8 #2-pipes (Yellow)
- 8 #1-pipes (Green)
- 2 I-joiners
- 4 L-joiners
- 4 T-joiners
- 12 Y-joiners

1

2X:

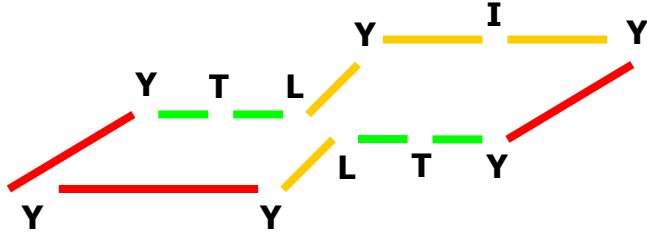

2

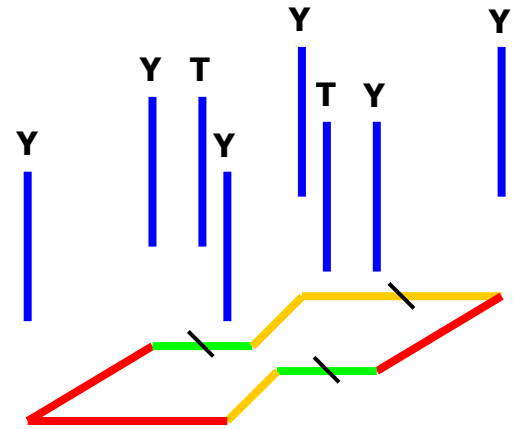

3

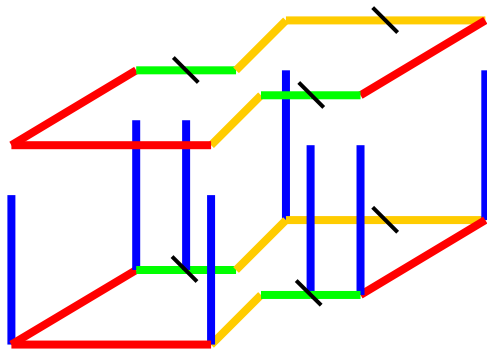

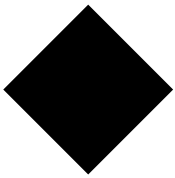

Two-room House

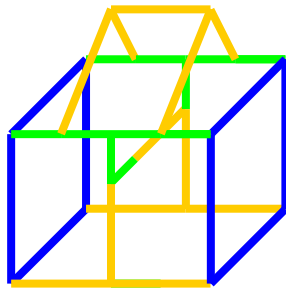

Parts

- 0 #4-pipes (Red)
- 8 #3-pipes (Blue)
- 12 #2-pipes (Yellow)
- 12 #1-pipes (Green)
- 1 I-joiners
- 0 L-joiners
- 10 T-joiners
- 10 Y-joiners

1

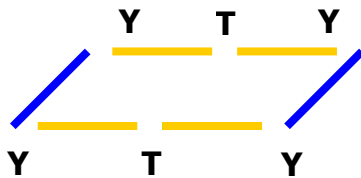

2

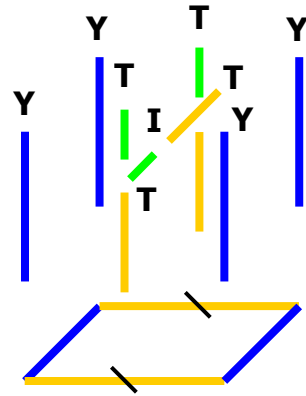

3

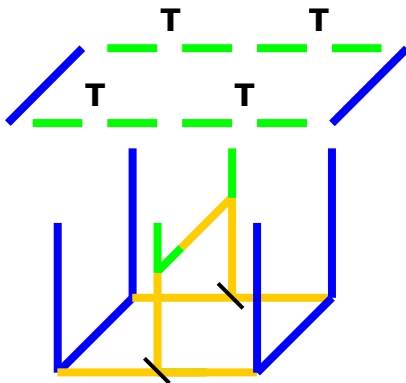

4

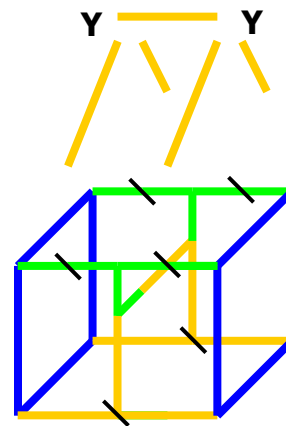

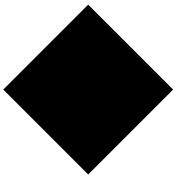

House with Carport

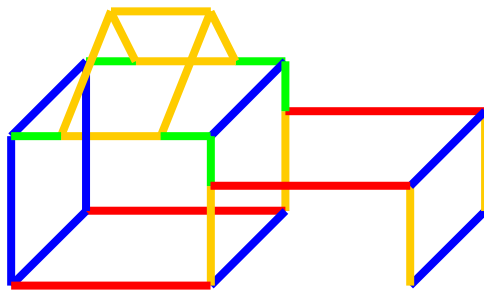

Parts

- 4 #4-pipes (Red)
- 8 #3-pipes (Blue)
- 11 #2-pipes (Yellow)
- 6 #1-pipes (Green)
- 0 I-joiners
- 2 L-joiners
- 6 T-joiners
- 12 Y-joiners

1

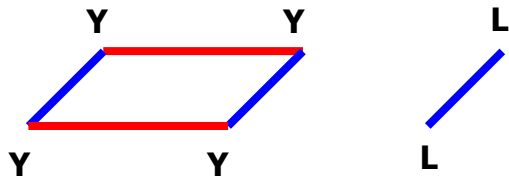

2

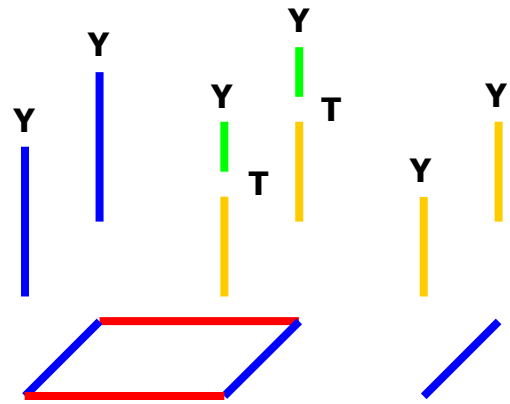

3

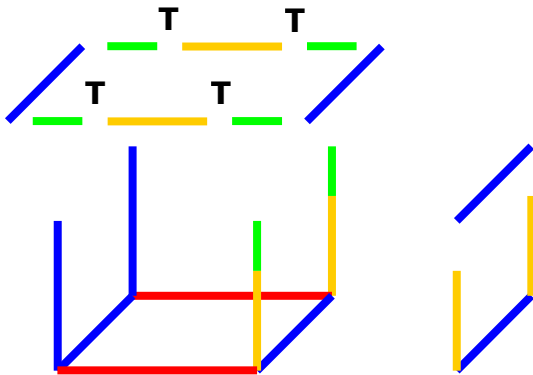

4

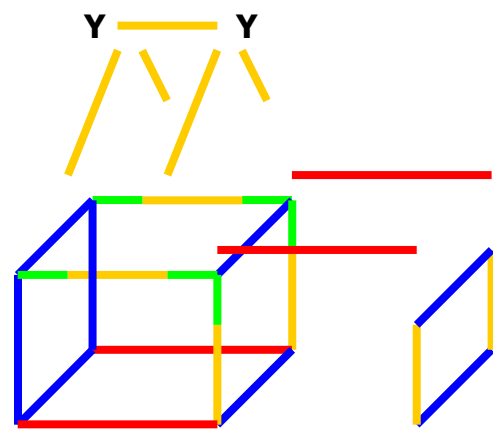

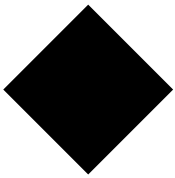

House with Window & Door

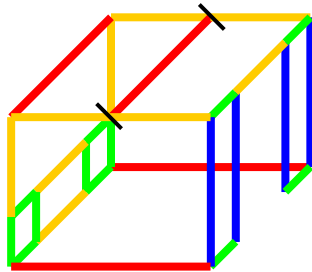

Parts

- 4 #4-pipes (Red)
- 4 #3-pipes (Blue)
- 9 #2-pipes (Yellow)
- 12 #1-pipes (Green)
- 0 I-joiners
- 2 L-joiners
- 10 T-joiners
- 8 Y-joiners

1

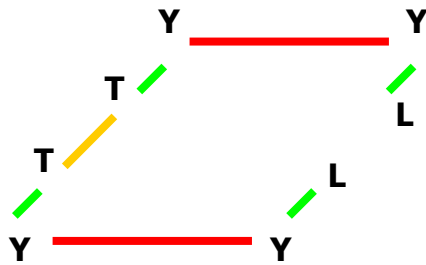

2

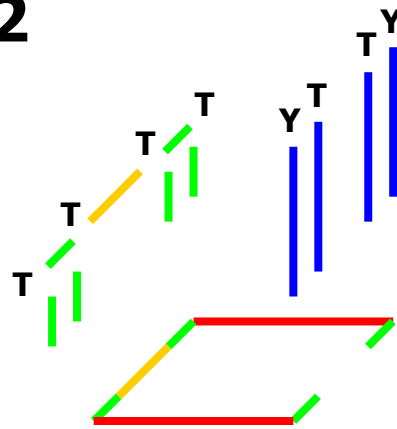

3

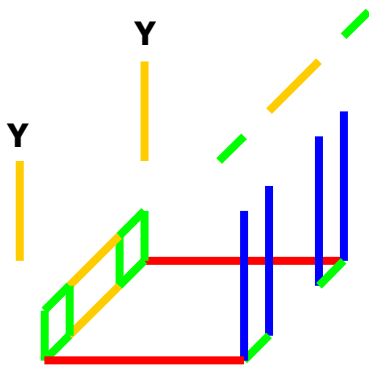

4

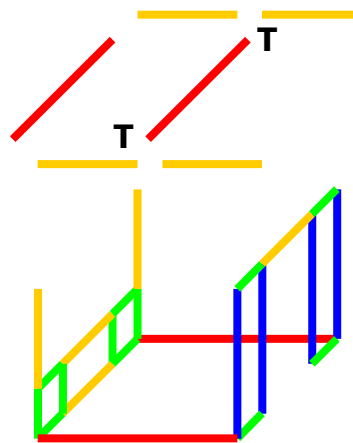

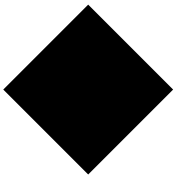

Boat

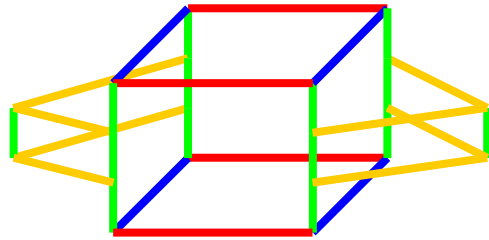

Parts

- 4 #4-pipes (Red)
- 4 #3-pipes (Blue)
- 8 #2-pipes (Yellow)
- 14 #1-pipes (Green)
- 0 I-joiners
- 0 L-joiners
- 8 T-joiners
- 12 Y-joiners

1

2X:

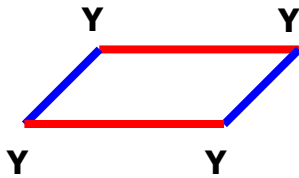

2

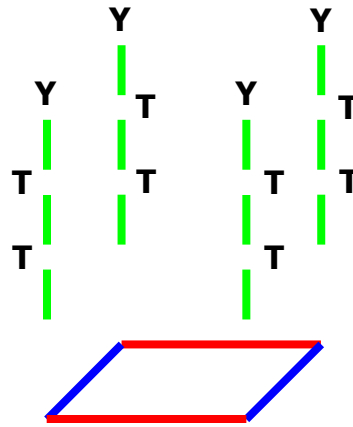

3

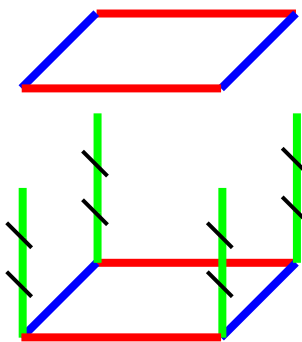

4

