

## FM 87-108MHz Radio Receiver DIY Kit

### 1.Introduction:

It is an= 87.0MHz-108.0MHz Wireless FM Radio Receiver DIY Kit with Red/Green spectrum indicator flashing automatically. It has a blue 4Bit segment display screen which can clearly display the receiving frequency.

It is a very interesting DIY electronic product which enables users to understand the circuit more clearly and learn soldering skills.

### 2.Feature:

1>.Multi-Audio Source Selectable: It supports Bluetooth/FM/U-disk/TF Card audio input which can play FM or MP3 or lossless music files. User also can play/pause/next/prev/vol+/vol- music by remote controller or on-board buttons.

2>.Bluetooth Player : Built-in Bluetooth audio receiver and power amplifier directly drive mono 4ohm 3W speakers and the sound is very clear. User also can connect headset.

3>.LED Spectrum : Built-in red/green LED spectrum indicators which can flashing with music to achieve dynamic and gorgeous lighting effect. Potentiometer adjustable sensitivity.

4>.Rechargeable: It is powered by 3.7v polymer lithium battery which can be used as outdoor mobile speaker. Built-in charging module is also more convenient for battery charging.

5>.DIY Hand Soldering. It's a DIY kit which comes with various components. User need to install each component by hand. It not only can exercise and improve soldering skills, but also increase the interest in electronic technology. Great for electronics hobbyists, beginners, school and home education.

### 3.Parameter:

1>.Product Name:FM 87-108MHz Radio Receiver DIY Kit

2>.Work Voltage:DC 4.5V~5.5V

3>.Output impedance:4ohm

4>.Output power:3W

5>.Output channel:Mono

6>.Audio source:Bluetooth/FM/U-disk/TF Card

7>.Output type: Speaker or AUX

8>.Receiver Frequency:87.0MHz~108.0MHz

9>.FM station: Automatic radio search

10>.Audio format:APE/FLAC/WAV/MP3/WMA

11>.Charging interface: DC-022 Power Socket

12>.Work Temperature:-40℃~85℃

13>.Work Humidity:5%~95%RH

14>.Size(Installed):98\*75\*45mm

### 4.Use Methods:

1>.MODE Button: Switch Audio Mode. Press button to switch Bluetooth/FM/AUX/U-disk/TF Card play mode. Note: Play U-disk/TF Card music first after insert USB flash disk or TF card.

2>.P/P Button: Short press to play or pause music. Keep press 3second to automatic radio search.

3>.NEXT Button: Short press to switch next music. Keep press 3second to increase volume V++.

4>.PREV Button:Short press to switch previous music. Keep press 3second to decrease volume V--.

### 5.Component Listing:

NO.	Component Name	PCB Marker	Parameter	QTY
1	Metal Film Resistor	R1	370ohm~10Kohm	1
2	Metal Film Resistor	R2	10Kohm	1
3	Electrolytic Capacitor	C2	10uF	1
4	Electrolytic Capacitor	C5	2.2uF	1
5	5mm Green LED	D1-D4		4
6	5mm Red LED	D5		1
7	4ohm 3W Speaker			1
8	KA2284 LED Driver	U2	SIP-9	1
9	Potentiometer	VR1	10Kohm	1

10	XH2.54 Male Pin	J1,J2	2Pin	2
11	Audio indicator PCB		47*19mm	1
12	Audio Wire			
13	USB-DC005 Power Wire			1
14	FM Antenna			1
15	FM Antenna Socket			
16	XH2.54-2P Wire		15cm	2
17	Black Wire		30cm	1
18	3.7V Polymer Lithium Battery			1
19	Bluetooth Amplifier Module			1
20	DC-005 Power Socket			1
21	Power Switch			1
22	Acrylic Board			6
23	M3*10mm Nylon Column			6
24	M3*6mm Nylon Screw			12
25	M3 Metal Screw			4
26	M2 Metal Screw			11
27	M3 Nut			4
28	M2 Nut			11

## 6.Application:

- 1>.Training welding skills
- 2>.Student school
- 3>.DIY production
- 4>.Project Design
- 5>.Electronic competition
- 6>.Gift giving
- 7>.Crafts collection
- 8>.Home decoration
- 9>.Souvenir collection
- 10>.Graduation design
- 11>.Holiday gifts

## 7.Note:

- 1>.It is a wireless module. So do not use it in an environment with signal interference.
- 2>.It is not recommended to play music when recharging to avoid damaging the battery.
- 3>.Keep press Play Button 3s to auto search for FM stations and save.

## 8.Installation Tips:

- 1>.User needs to prepare the welding tool at first.
  - 1.1>.Soldering iron (<50 Watt)
  - 1.2>.Rosin core ("radio") solder
  - 1.3>.Wire cutters
  - 1.4>.Wire strippers
  - 1.5>.Philips screwdriver
- 2>.Please be patient until the installation is complete.
- 3>.The package is DIY kit.It need finish install by user.
- 4>.The soldering iron can't touch the components for a long time(1.0 second), otherwise it will damage the components.
- 5>.Pay attention to the positive and negative of the components.
- 6>.Strictly prohibit short circuit.
- 7>.User must install the LED according to the specified rules.Otherwise some LED will not light.
- 8>.Install complex components preferentially.
- 9>.Make sure all components are in right direction and right place.
- 10>.It is strongly recommended to read the installation manual before starting installation!!!

11>.Please wear anti-static gloves or anti-static wristbands when installing electronic components.

## 9.Installation Steps(Please be patient install!!!):

- 1>.Step 1: Install 1pcs 370ohm~10Kohm Metal Film Resistor at R1.
- 2>.Step 2: Install 1pcs 10Kohm Metal Film Resistor at R2.
- 3>.Step 3: Use the tool to bend the LED pin as shown in the figure. Pay attention to the bending point and direction.
- 4>.Step 4: Install 1pcs 5mm Red LED at D5.
- 5>.Step 5: Install 4pcs 5mm Green LED at D1-D4.
- 6>.Step 6: Install 1pcs SIP-9 KA2284 LED Driver at U2. Pay attention to the installation direction.
- 7>.Step 7: Bend the pins of 10uF electrolytic capacitor about 2mm. Then install this Electrolytic Capacitor at C2. Pay attention to distinguish between positive and negative. The Longer pin is positive pole and connect to ' + ' pad. Note: The capacitor needs to be placed horizontally. Otherwise, the following components cannot be installed.
- 8>.Step 8: Bend and install 1pcs 2.2uF electrolytic capacitor at C5 by the same method.
- 9>.Step 9: Install 1pcs 10K 503 Potentiometer at VR1.
- 10>.Step 10: Connect 1pcs 15cm XH2.54-2P Wire to PCB as showing. Red wire to ' + ' pad at J1. Black wire to the lowest pad at J2.
- 11>.Step 11: Cut about 15cm black wire from 30cm wire and connect it to another pad at J2.
- 12>.Step 12: Connect 1pcs 15cm XH2.54-2P Wire to 4ohm 3W Speaker. Red wire to ' + ' pad.
- 13>.Step 13: Cut about 5cm black wire from 30cm wire and connect it to ANT pad at Bluetooth Amplifier Module, which are used to connect FM antenna socket.
- 14>.Step 14: Connect this 5cm black wire to FM Antenna Socket at the longest metal pin.
- 15>.Step 15: Tear off the protective film on the surface of the acrylic shell.
- 16>.Step 16: Fix 1pcs Black Power Switch on acrylic panel. Pay attention to the buckle on the switch, which can be fixed by itself.Pay attention to the installation direction.
- 17>.Step 17: Fix 1pcs DC-022 Power Socket by the biggest nut on acrylic panel.
- 18>.Step 18: Cut about 3cm black wire to connect DC-022 Socket and Black Power Switch.Pay attention to their pin selection and can not choose to connect other pins.
- 19>.Step 19: Cut about 8cm black wire and connect to another pin on Black Power Switch.
- 20>.Step 20: Cut about 8cm black wire and connect to the pin as showing on DC-022 Socket.
- 21>.Step 21: Connect black wire from Black Power Switch to ' + ' pad at J1 at PCB.
- 22>.Step 22: Connect black wire from Black DC-022 Socket to ' - ' pad at J1 at PCB.
- 23>.Step 23: Fix 3.7V Polymer Lithium Battery. Red wire connect to Black Power Switch and black to PCB.
- 24>.Step 24: Fix 15cm black wire from PCB to the left male pin at Bluetooth Amplifier Module.
- 25>.Step 25: Bend the two rightmost male pins and insert the XH2.54-2P plug from PCB.
- 26>.Step 26: Test after connect 4ohm 3W Speaker.
- 27>.Step 27: Fix speaker on Acrylic Board by 4pcs M3 Metal Screw and 4pcs M3 Nuts.
- 28>.Step 28: Fix 4pcs M3\*10mm Nylon Column on Bluetooth Amplifier Module by 4pcs M3\*6mm Nylon Screw.
- 29>.Step 29: Fix Bluetooth Amplifier Module Acrylic TOP Board by 4pcs M3 Nylon Screw.
- 30>.Step 30: Fix 4pcs M3\*10mm Nylon Column on PCB by 4pcs M3\*6mm Nylon Screw.
- 31>.Step 31: Fix Audio Indicator PCB another Acrylic Board by 4pcs M3 Nylon Screw.
- 32>.Step 32: Paste double-sided adhesive or other fixing adhesive on the back of the battery.
- 33>.Step 33: Paste 3.7V Polymer Lithium Battery on Acrylic Board.
- 34>.Step 34: Fix Bluetooth Amplifier Acrylic Board on Power Switch Acrylic by M2 Metal Screw and M2 Nut. Tips: It is recommended to ask for help from others or tools to stabilize the shell and screws.
- 35>.Step 35: Fix Audio Indicator PCB Acrylic Board on Power Switch Acrylic by M2 Metal Screw and M2 Nut.
- 36>.Step 36: Fix Speaker Acrylic Board by M2 Metal Screw and M2 Nut.Check the wire connection.
- 37>.Step 37: Fix one side Acrylic Board by 4pcs M2 Metal Screw and 4pcs M2 Nut.
- 38>.Step 38: Fix the last side Acrylic Board by 4pcs M2 Metal Screw and 4pcs M2 Nut.

## 10.Install shown steps:

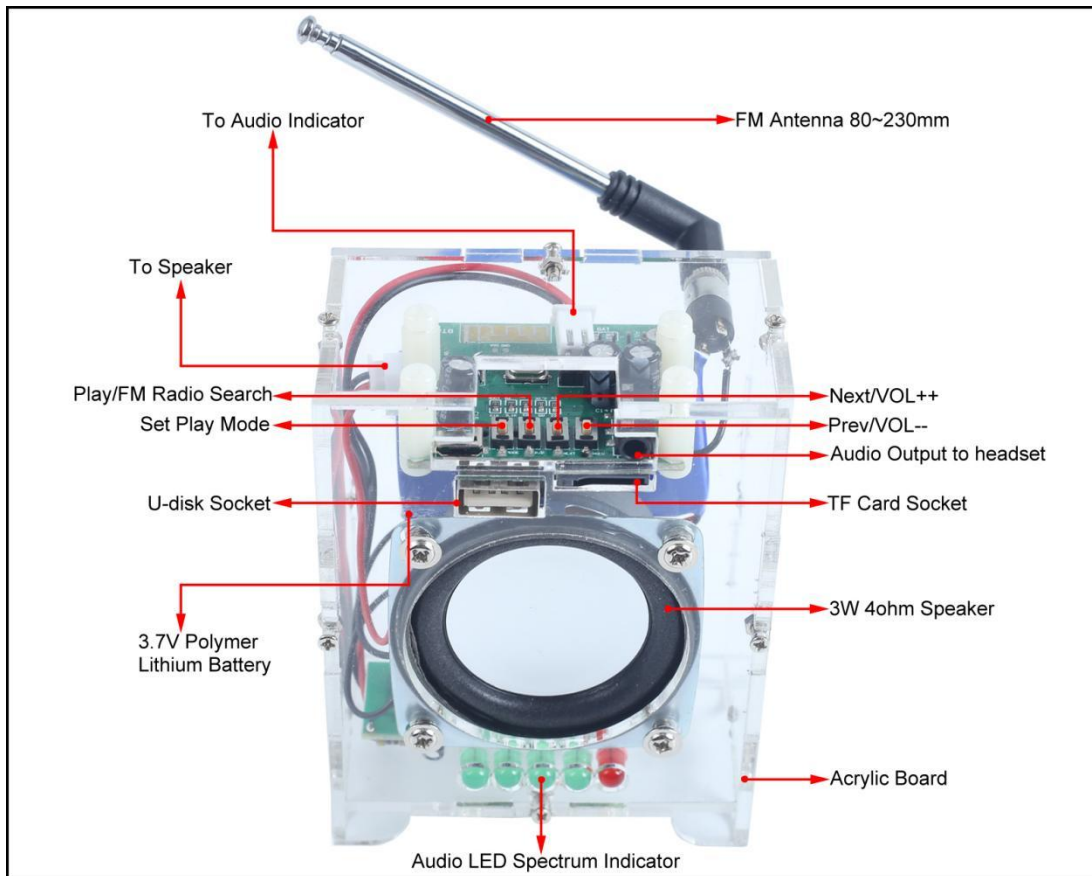
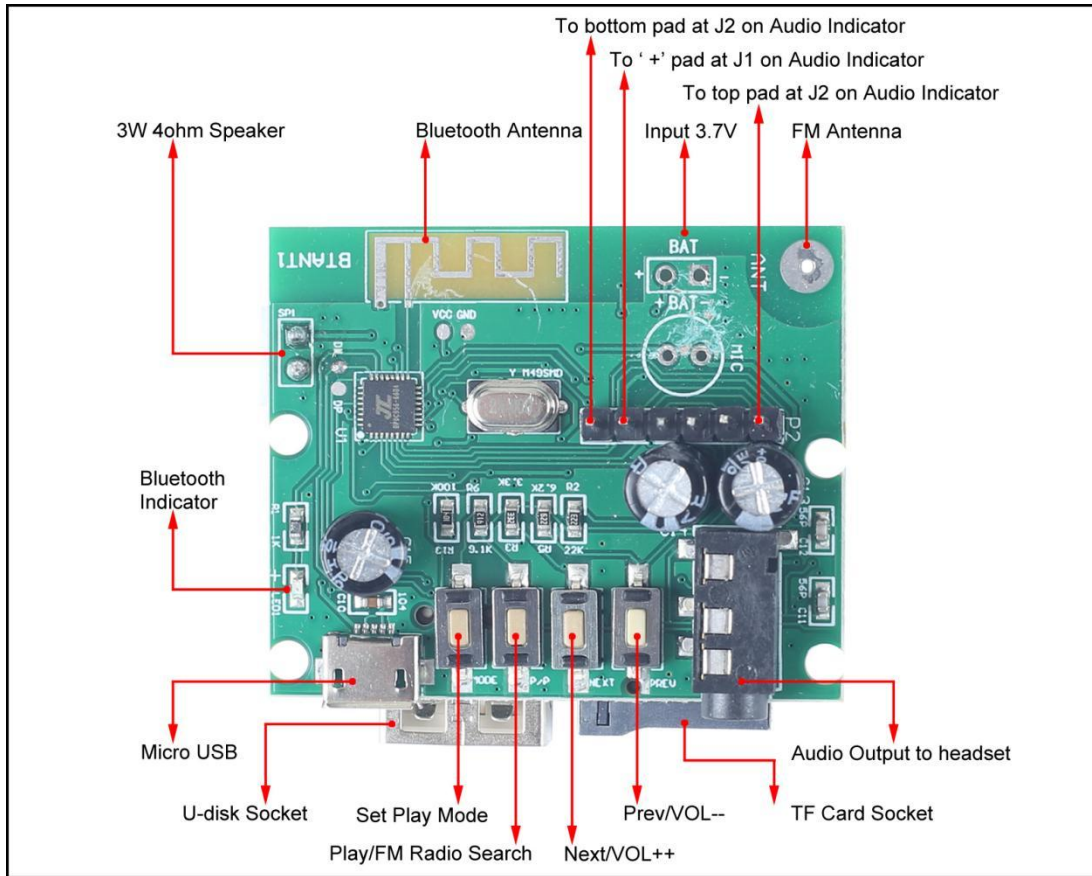

Step 1: Install 1pcs 370ohm~10Kohm Metal Film Resistor at R1.

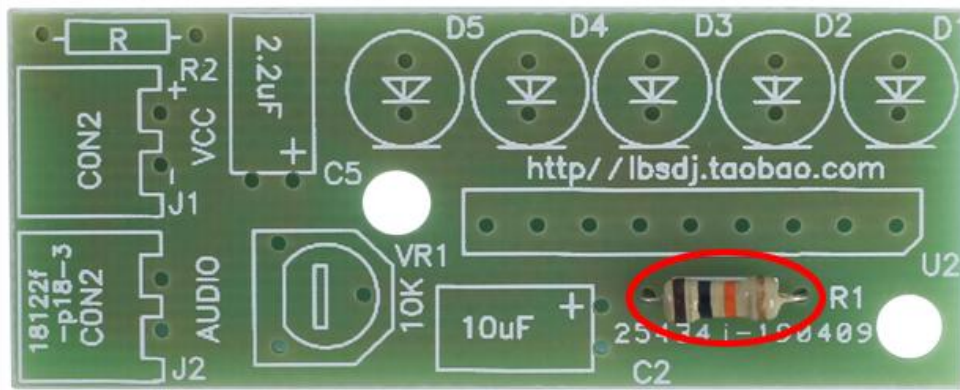

Step 2: Install 1pcs 10Kohm Metal Film Resistor at R2.

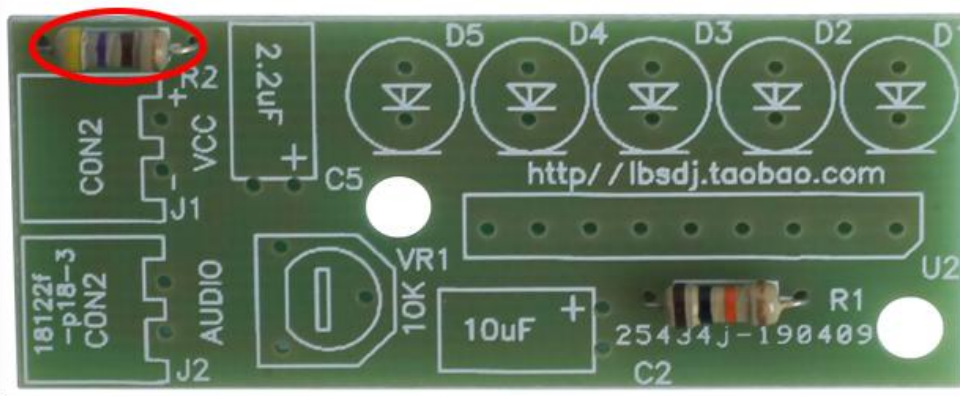

Step 3: Use the tool to bend the LED pin as shown in the figure. Pay attention to the bending point and direction.

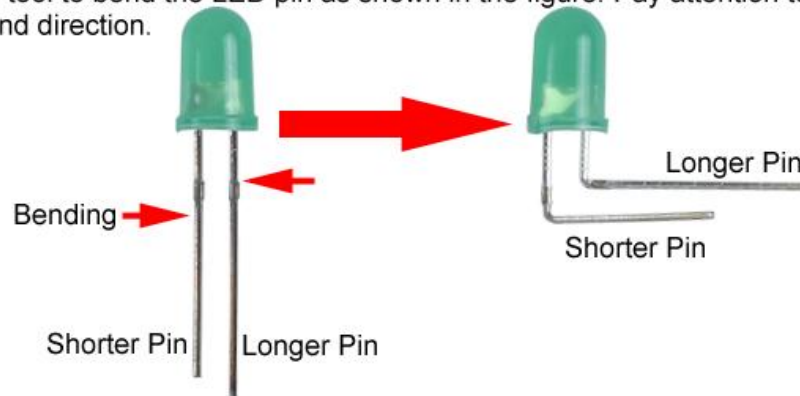

Step 4: Install 1pcs 5mm Red LED at D5.



Step 5: Install 4pcs 5mm Green LED at D1-D4.

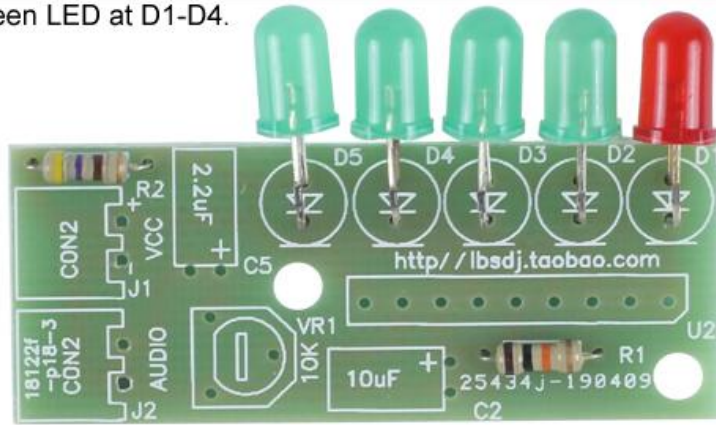

Step 6: Install 1pcs SIP-9 KA2284 LED Driver at U2. Note the installation direction.

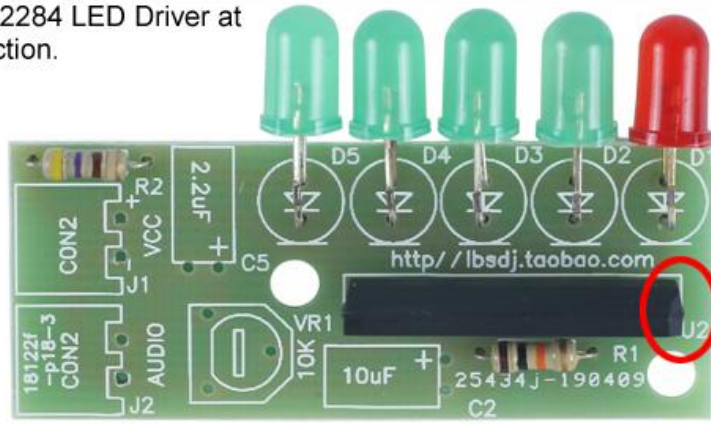

Step 7: Bend the pins of 10uF electrolytic capacitor about 2mm. Then install this Electrolytic Capacitor at C2. Pay attention to distinguish between positive and negative. The Longer pin is positive pole and connect to '+' pad. Note: The capacitor needs to be placed horizontally. Otherwise, the following components cannot be installed.

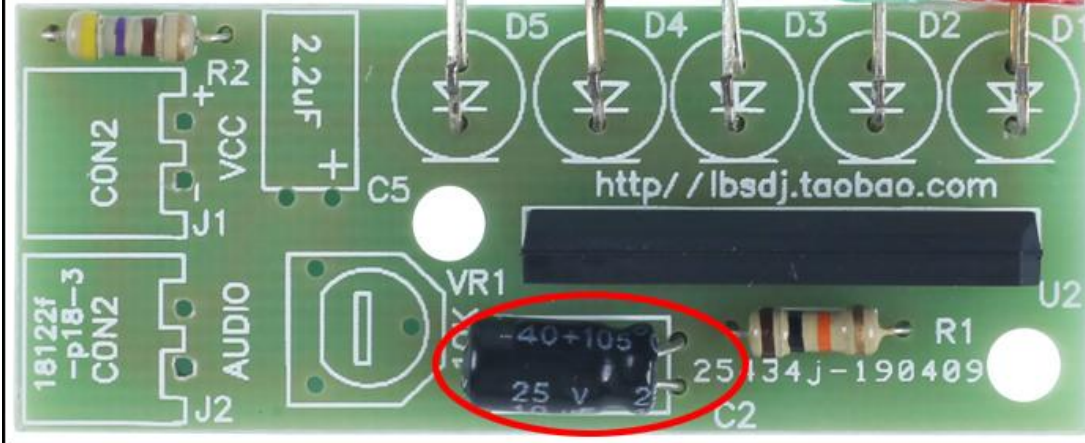

Step 8: Bend and install 1pcs 2.2uF electrolytic capacitor at C5 by the same method.

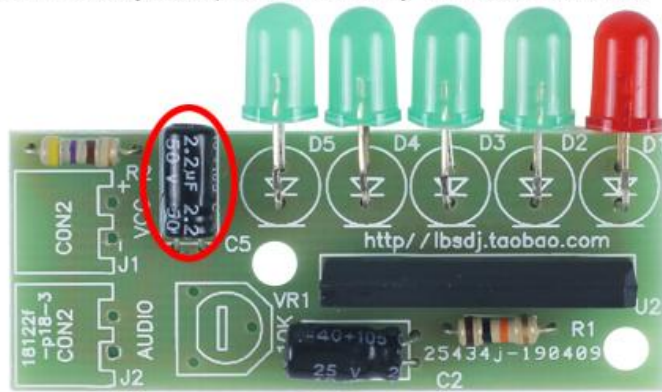

Step 9: Install 1pcs 10K 503 Potentiometer at VR1.



Step 10: Connect 1pcs 15cm XH2.54-2P Wire to PCB as showing. Red wire to '+' pad at J1. Black wire to the lowest pad at J2.

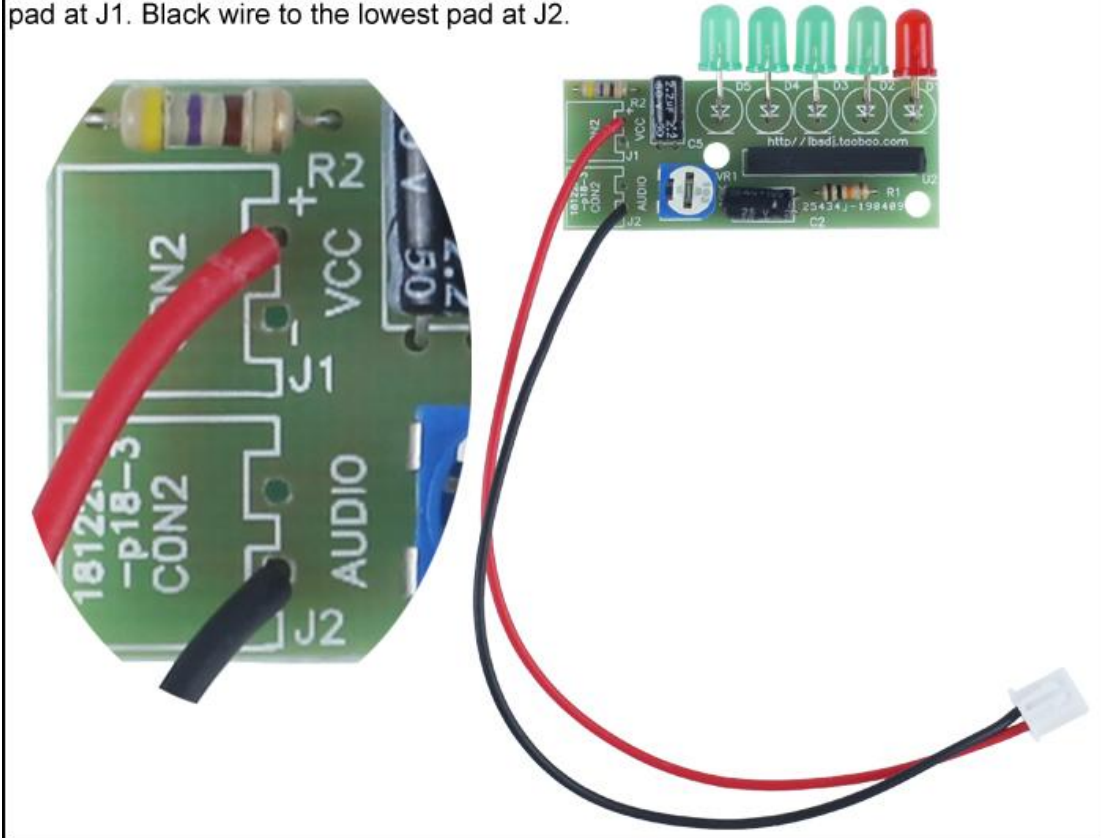

Step 11: Cut about 15cm black wire from 30cm wire and connect to another pad at J2.

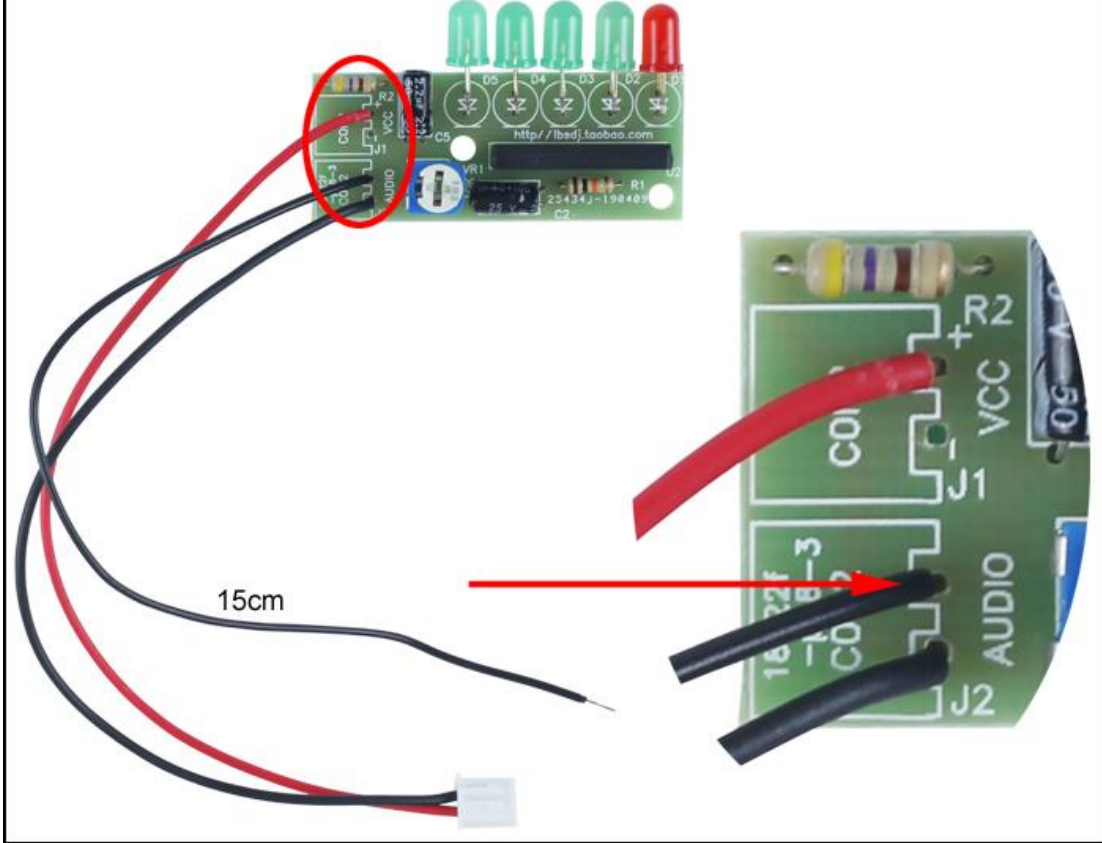

Step 12: Connect 1pcs 15cm XH2.54-2P Wire to 4ohm 3W Speaker. Red wire to ' + ' pad.





Step 13: Cut about 5cm black wire from 30cm wire and connect it to ANT pad at Bluetooth Amplifier Module, which are used to connect FM antenna socket.

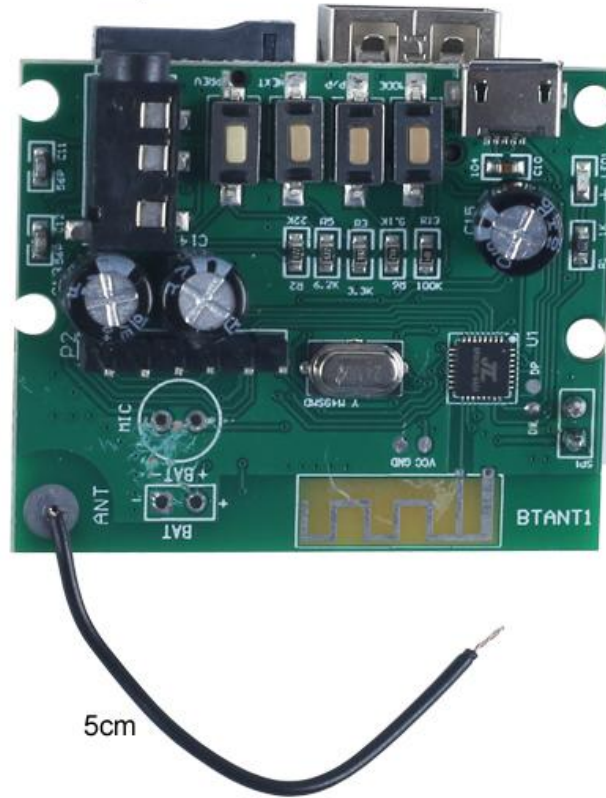

Step 14: Connect this 5cm black wire to FM Antenna Socket at the longest metal pin.

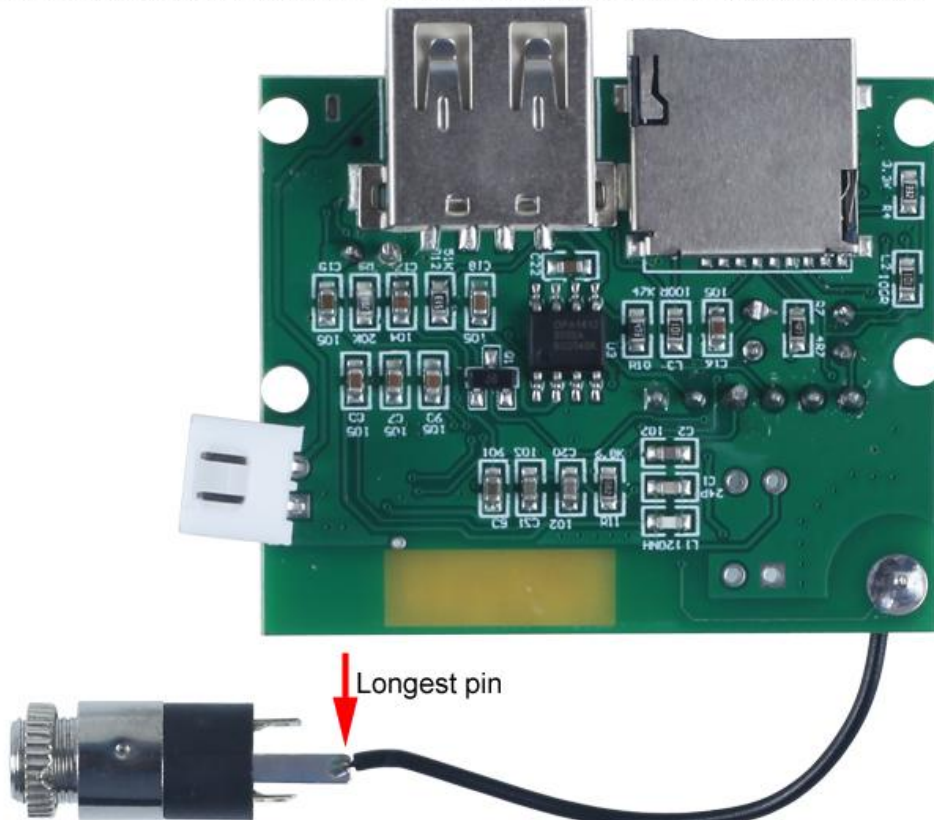

Step 15: Tear off the protective film on the surface of the acrylic shell.



Step 16: Fix 1pcs Black Power Switch on acrylic panel. Pay attention to the buckle on the switch, which can be fixed by itself. Pay attention to the installation direction.



Step 17: Fix 1pcs DC-022 Power Socket by the biggest nut on acrylic panel.



Step 18: Cut about 3cm black wire to connect DC-022 Socket and Black Power Switch. Pay attention to their pin selection and can not choose to connect other pins.

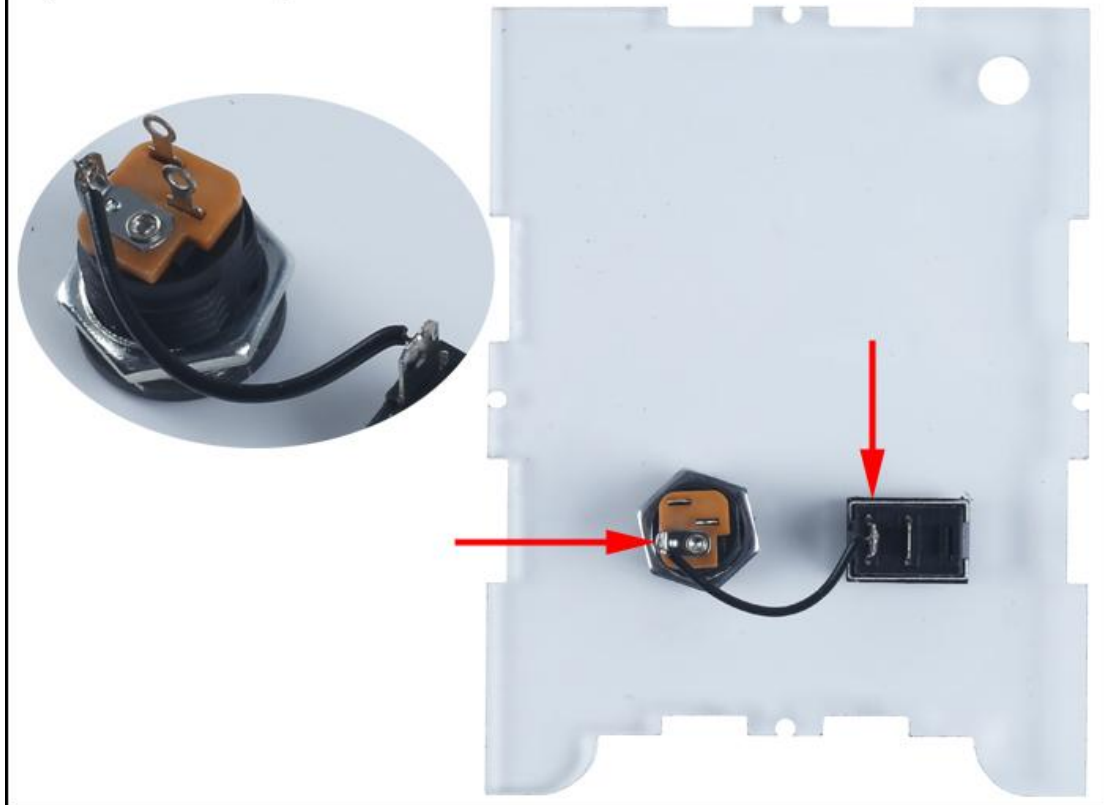

Step 19: Cut about 8cm black wire and connect to another pin on Black Power Switch.

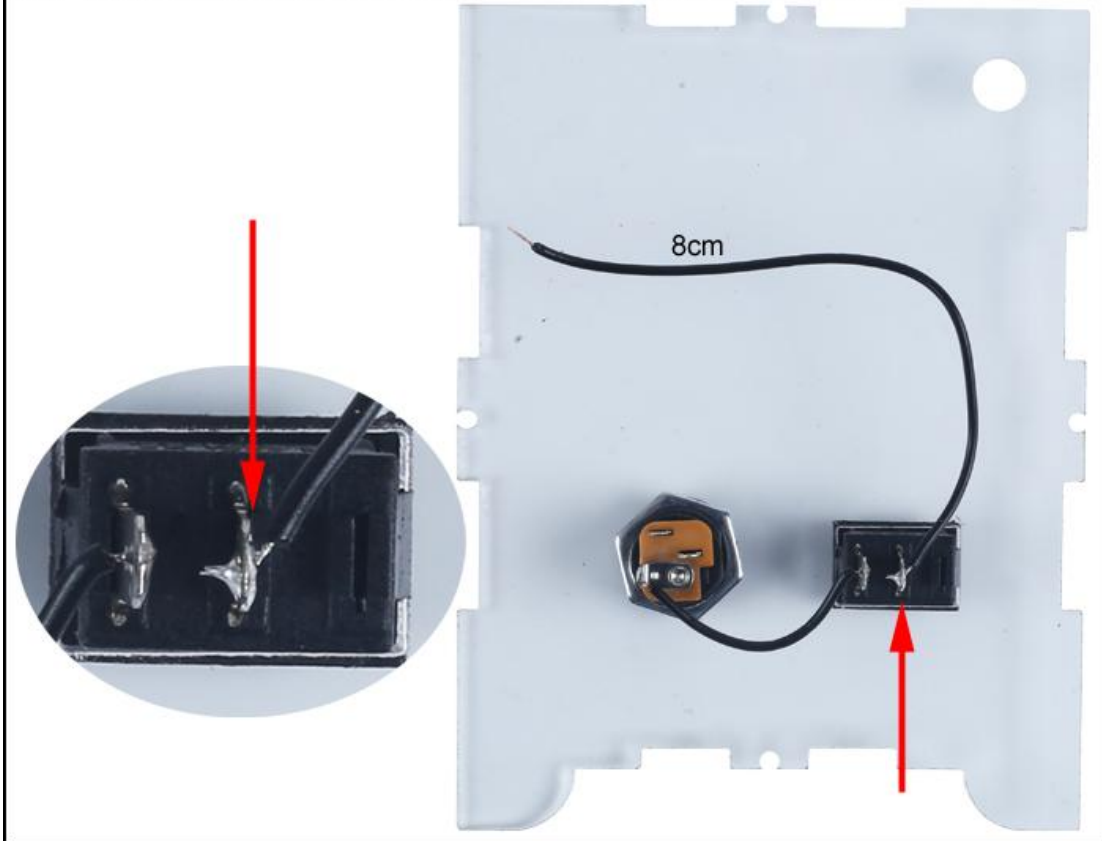

Step 20: Cut about 8cm black wire and connect to the pin as showing on DC-022 Socket.

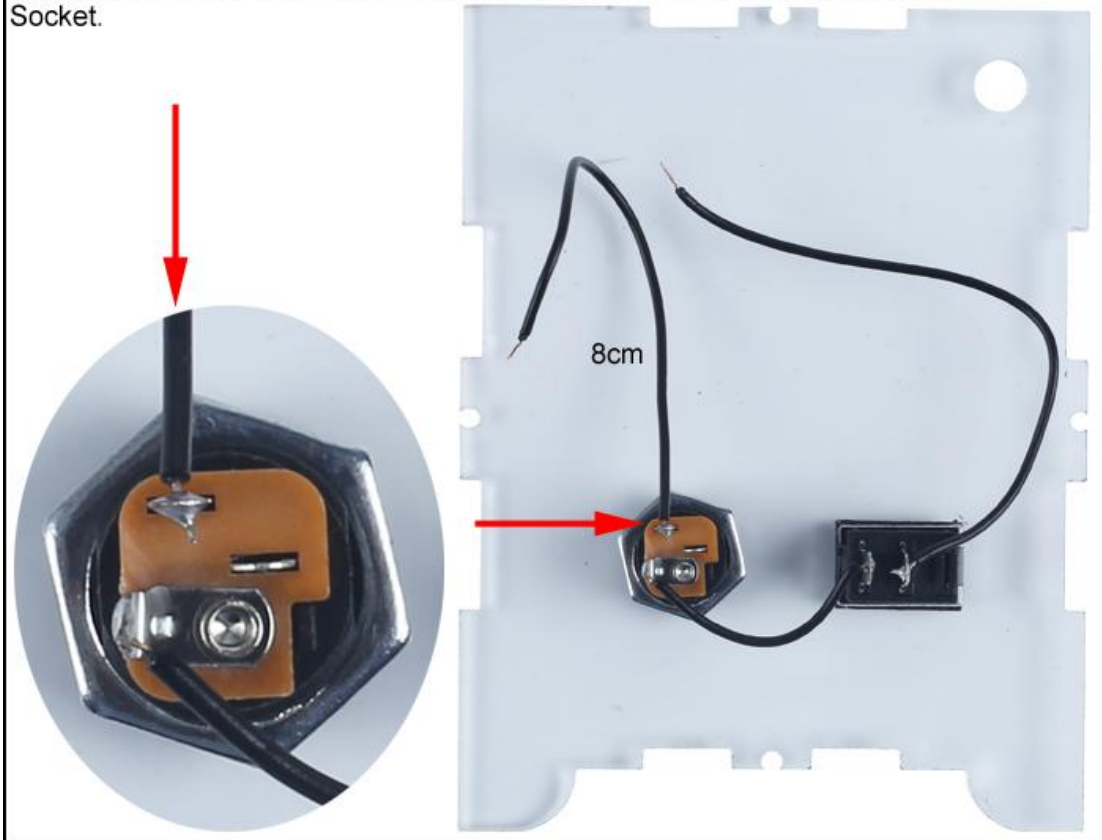

Step 25: Bend the two rightmost male pins and insert the XH2.54-2P plug from PCB.

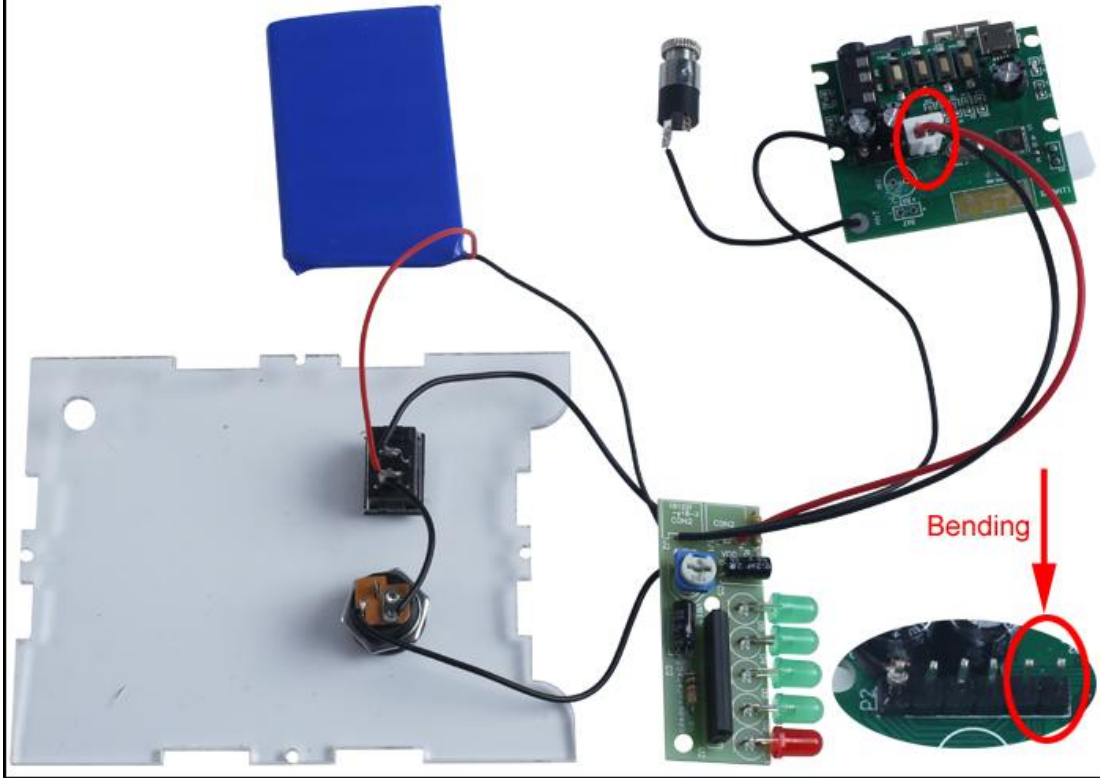

Step 26: Test after connect 4ohm 3W Speaker.

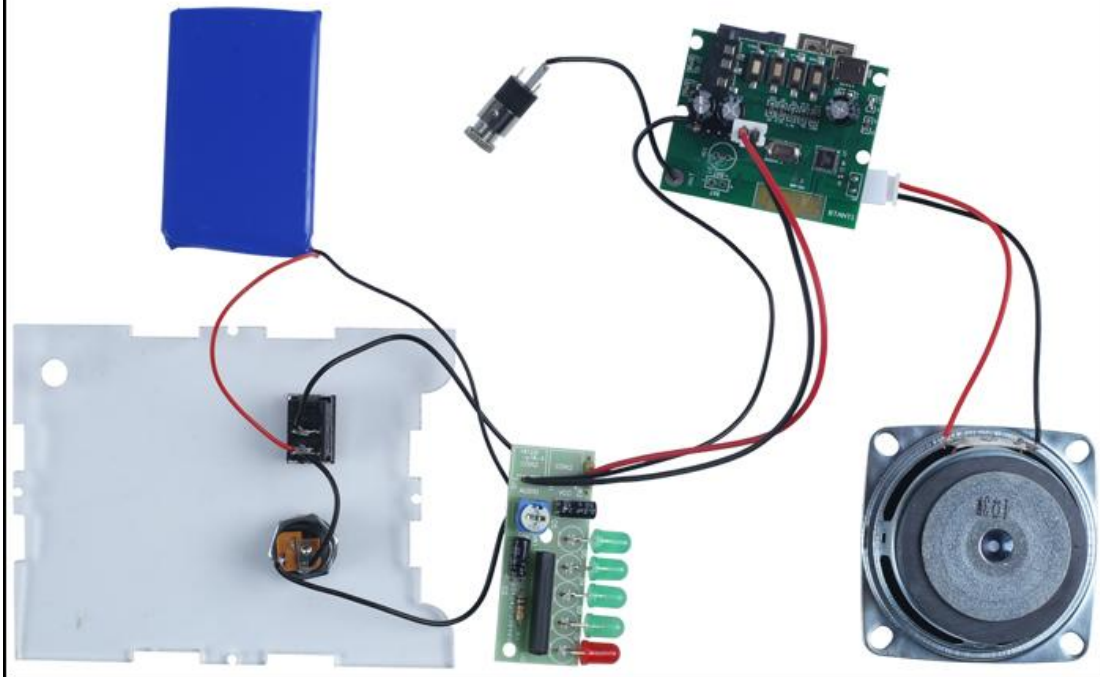

Step 27: Fix speaker on Acrylic Board by 4pcs M3 Metal Screw and 4pcs M3 Nuts.

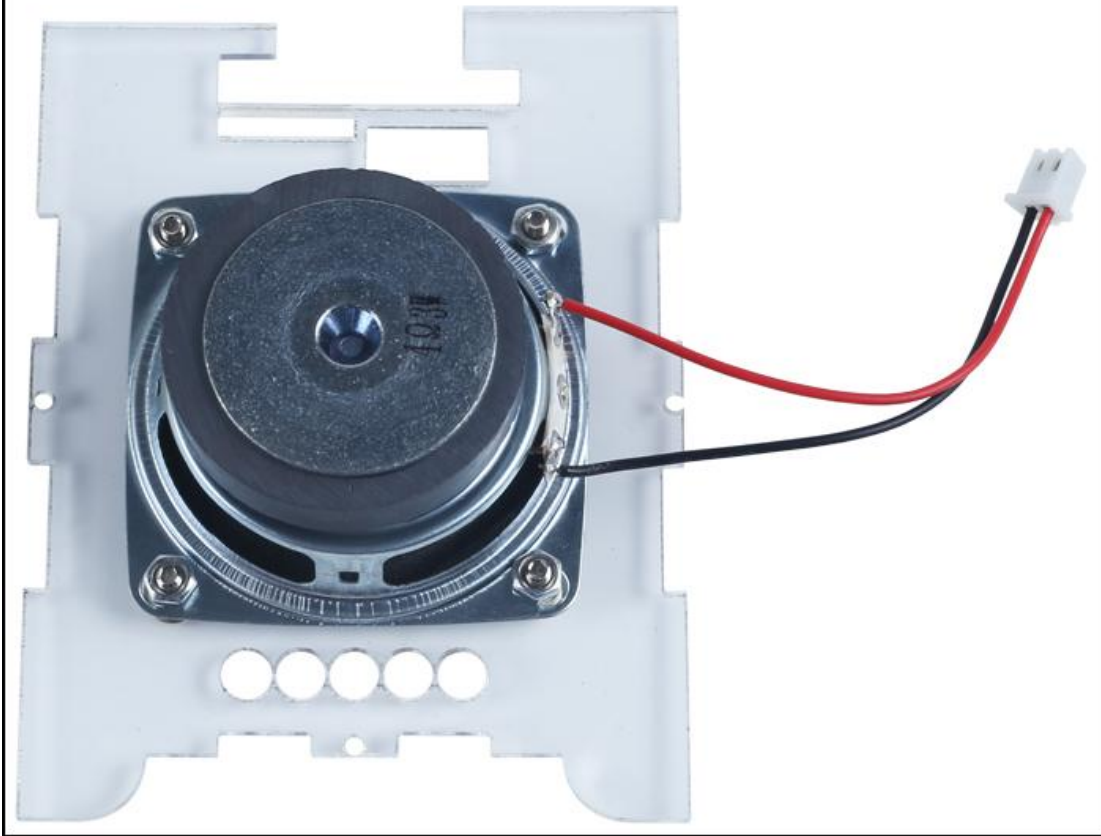

Step 28: Fix 4pcs M3\*10mm Nylon Column on Bluetooth Amplifier Module by 4pcs M3\*6mm Nylon Screw.

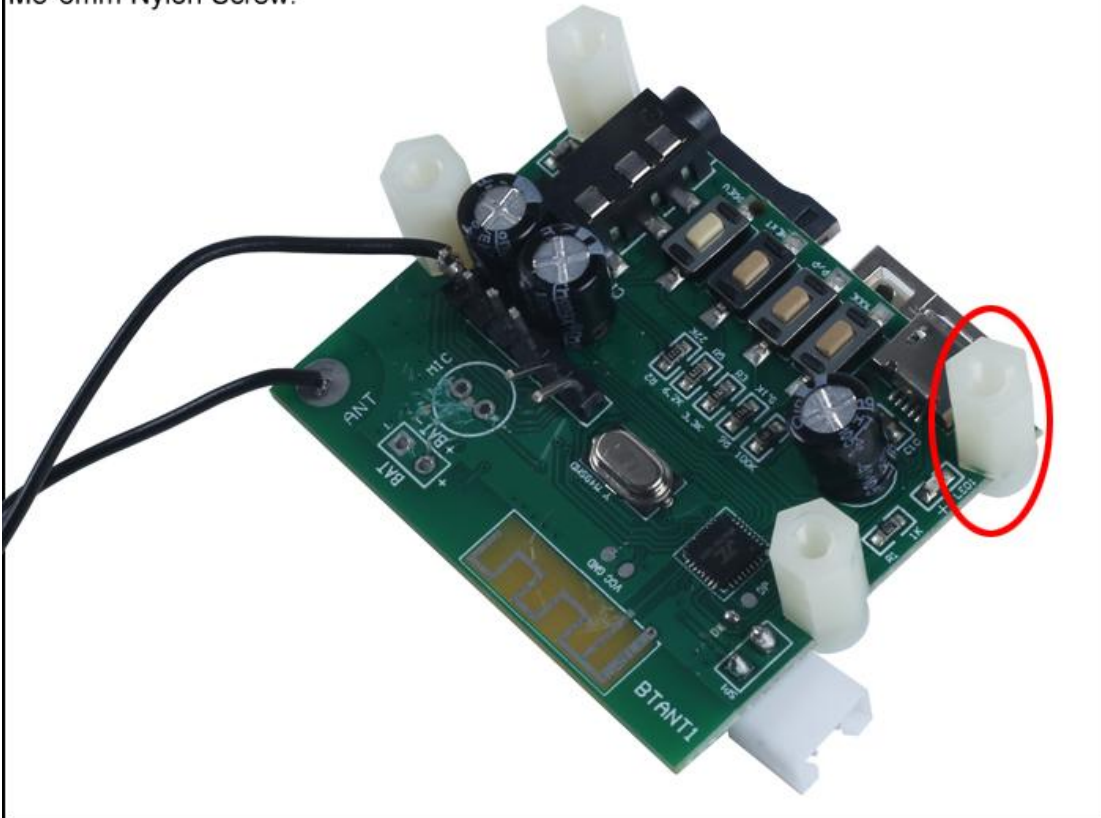

Step 29: Fix Bluetooth Amplifier Module Acrylic TOP Board by 4pcs M3 Nylon Screw.

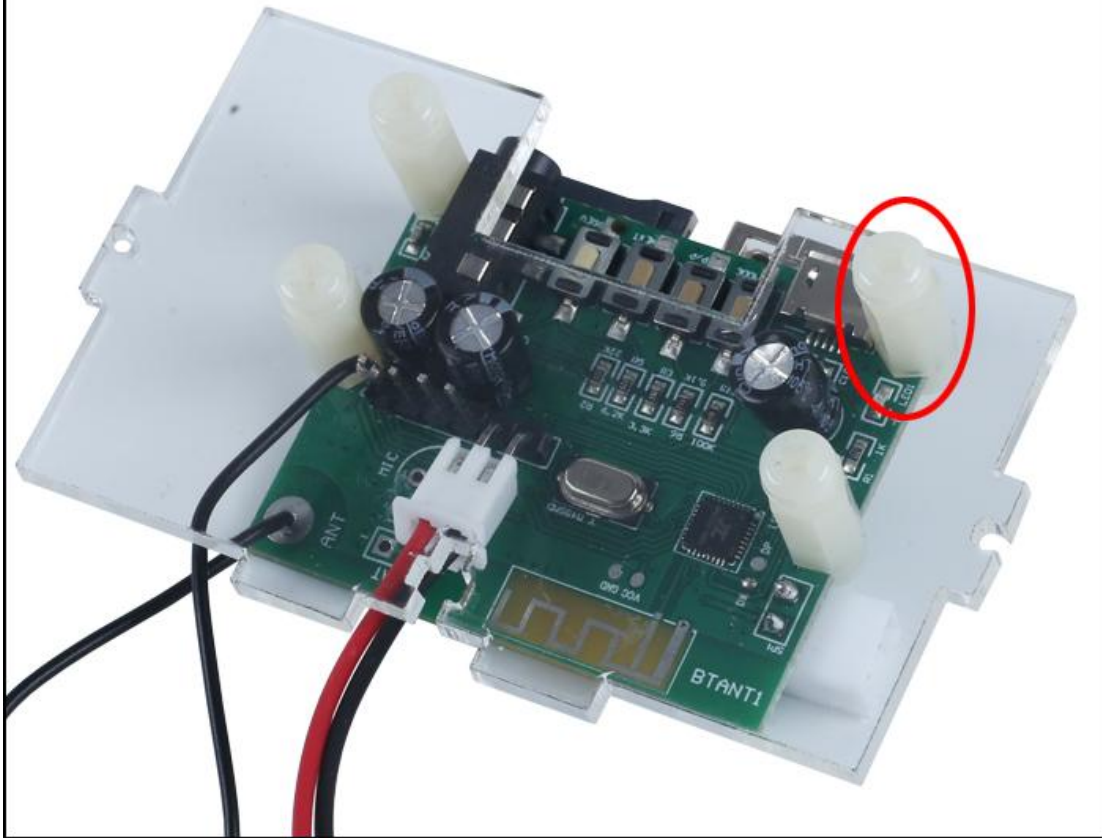

Step 30: Fix 4pcs M3\*10mm Nylon Column on PCB by 4pcs M3\*6mm Nylon Screw.

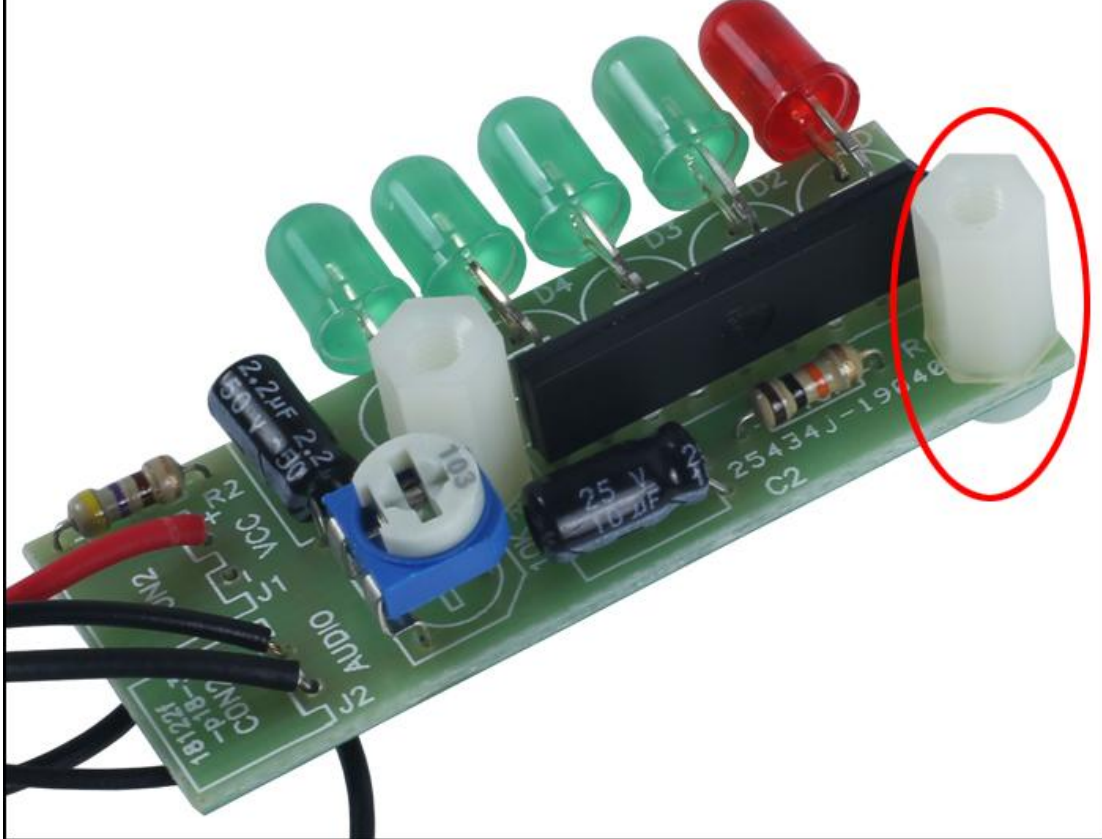

Step 31: Fix Audio Indicator PCB another Acrylic Board by 4pcs M3 Nylon Screw.

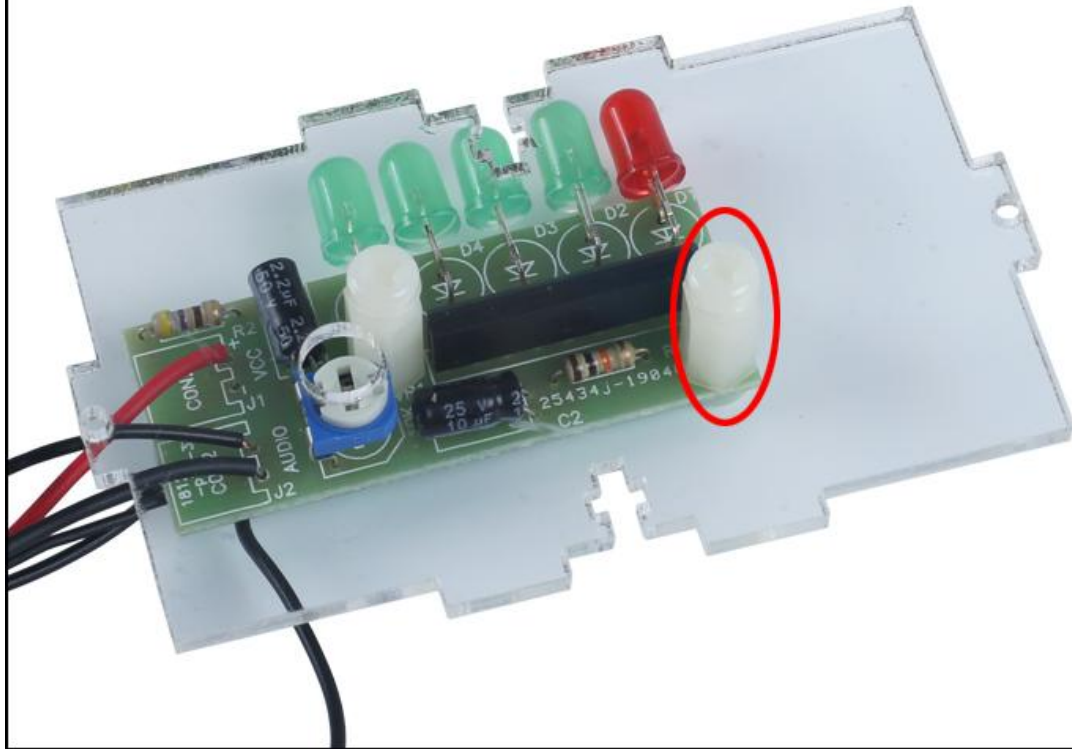

Step 32: Paste double-sided adhesive or other fixing adhesive on the back of battery.

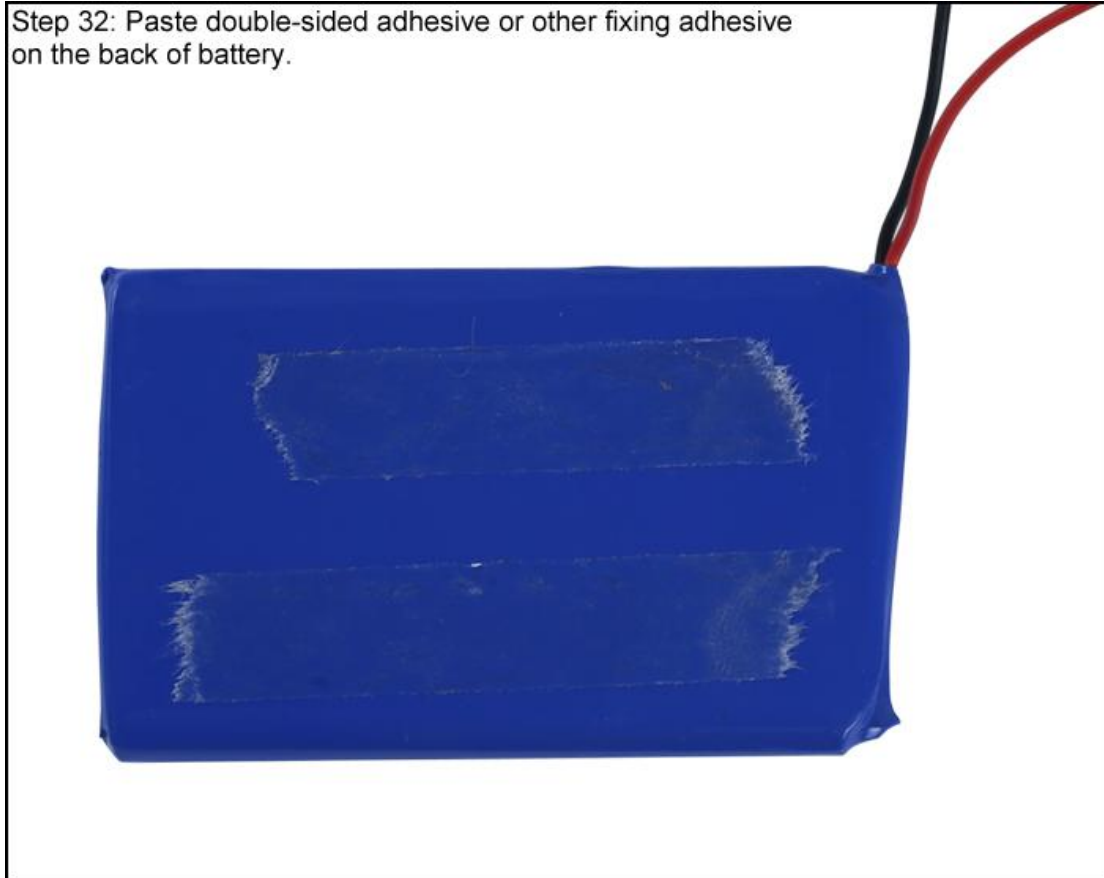



Step 33: Paste 3.7V Polymer Lithium Battery on Acrylic Board.

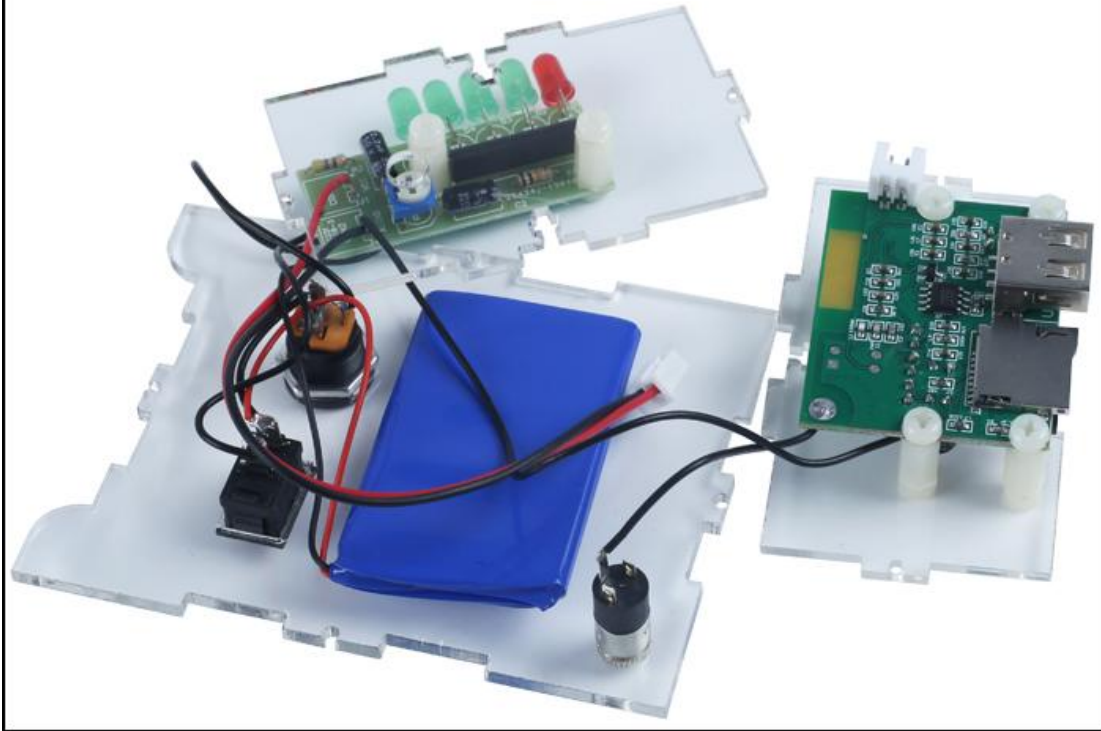

Step 34: Fix Bluetooth Amplifier Acrylic Board on Power Switch Acrylic by M2 Metal Screw and M2 Nut.

Tips: It is recommended to ask for help from others or tools to stabilize shell and screw.

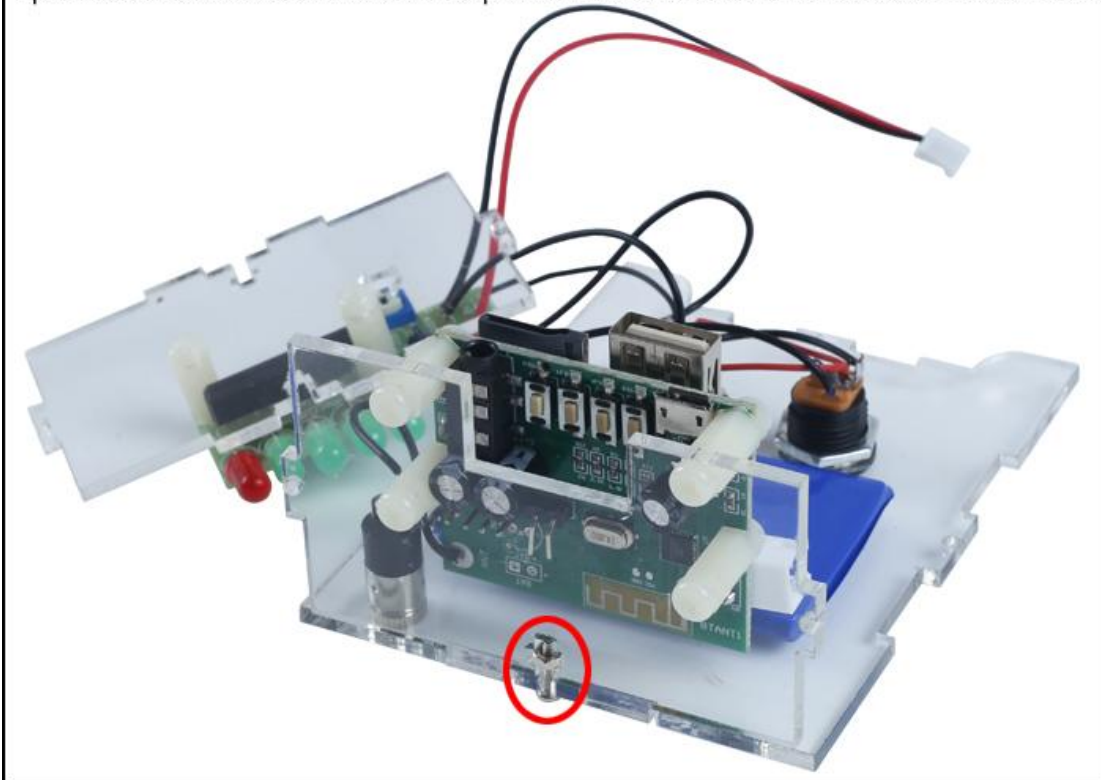

Step 35: Fix Audio Indicator PCB Acrylic Board on Power Switch Acrylic by M2 Metal Screw and M2 Nut.

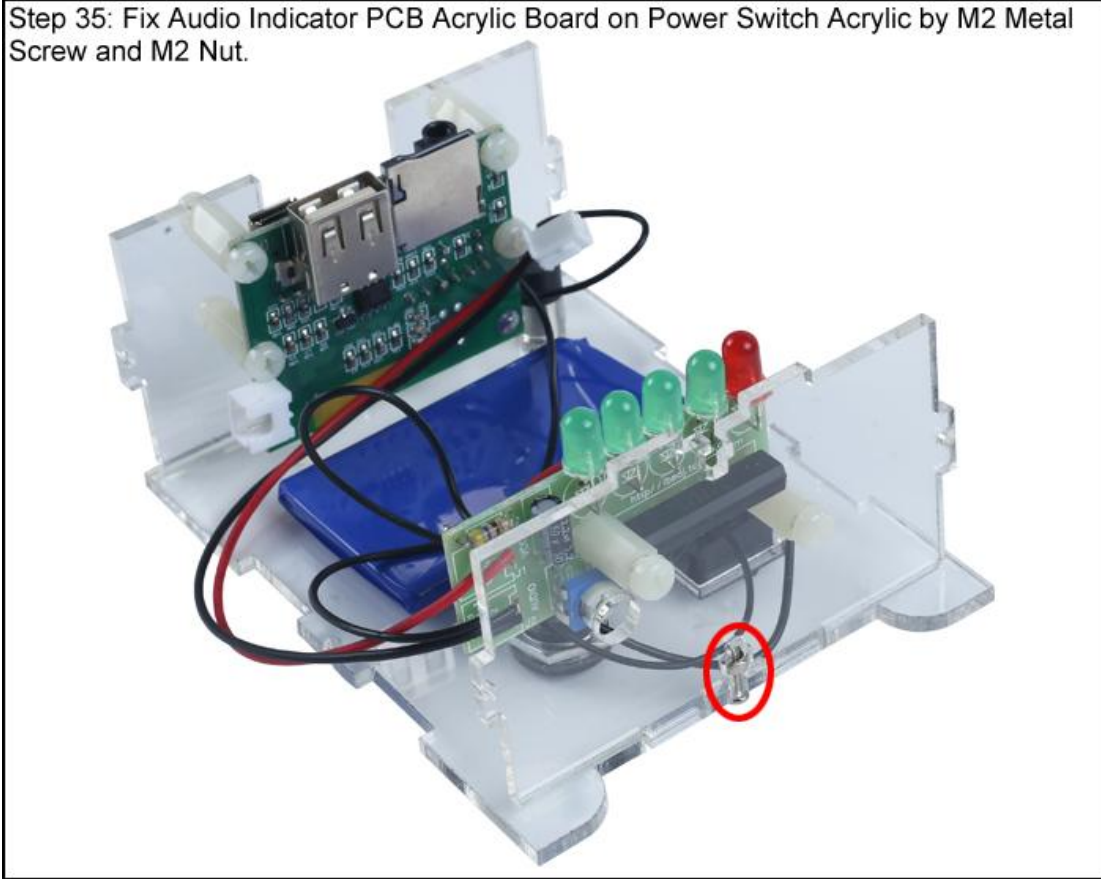

Step 36: Fix Speaker Acrylic Board by M2 Metal Screw and M2 Nut. Check the wire connection

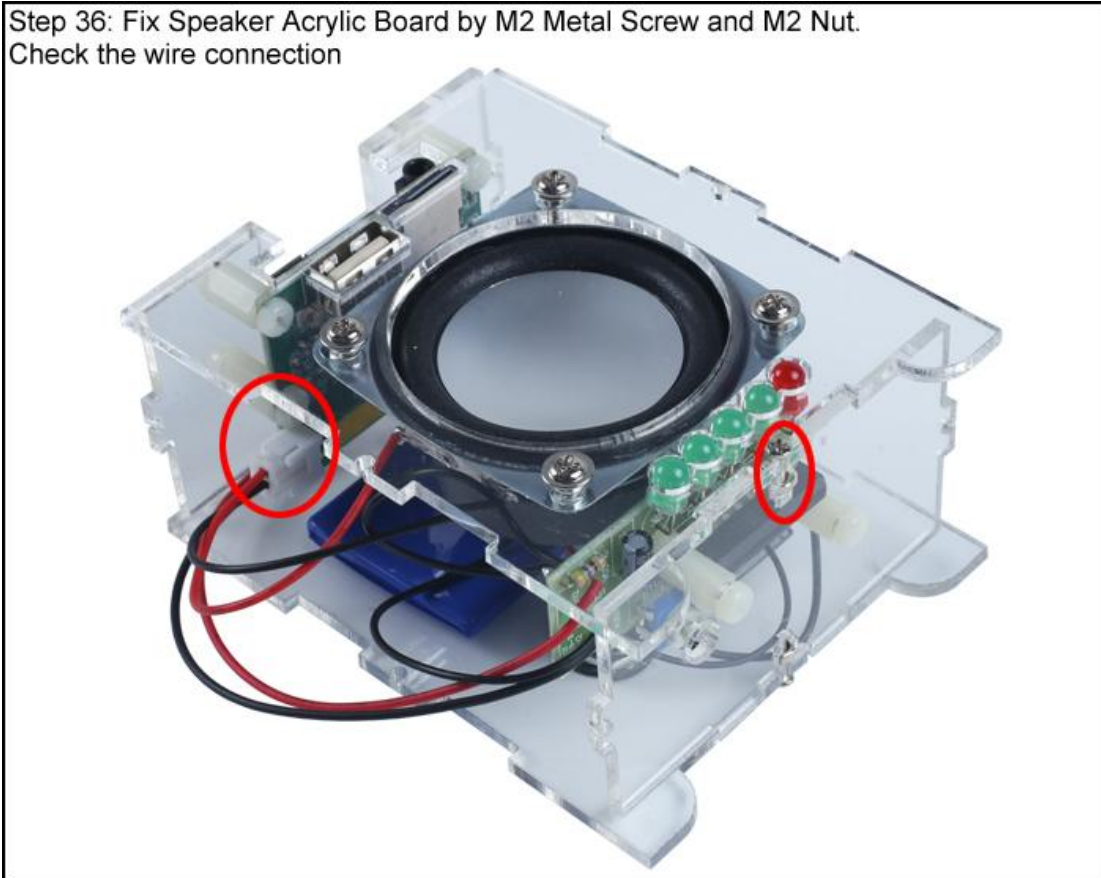

Step 37: Fix one side Acrylic Board by 4pcs M2 Metal Screw and 4pcs M2 Nut.

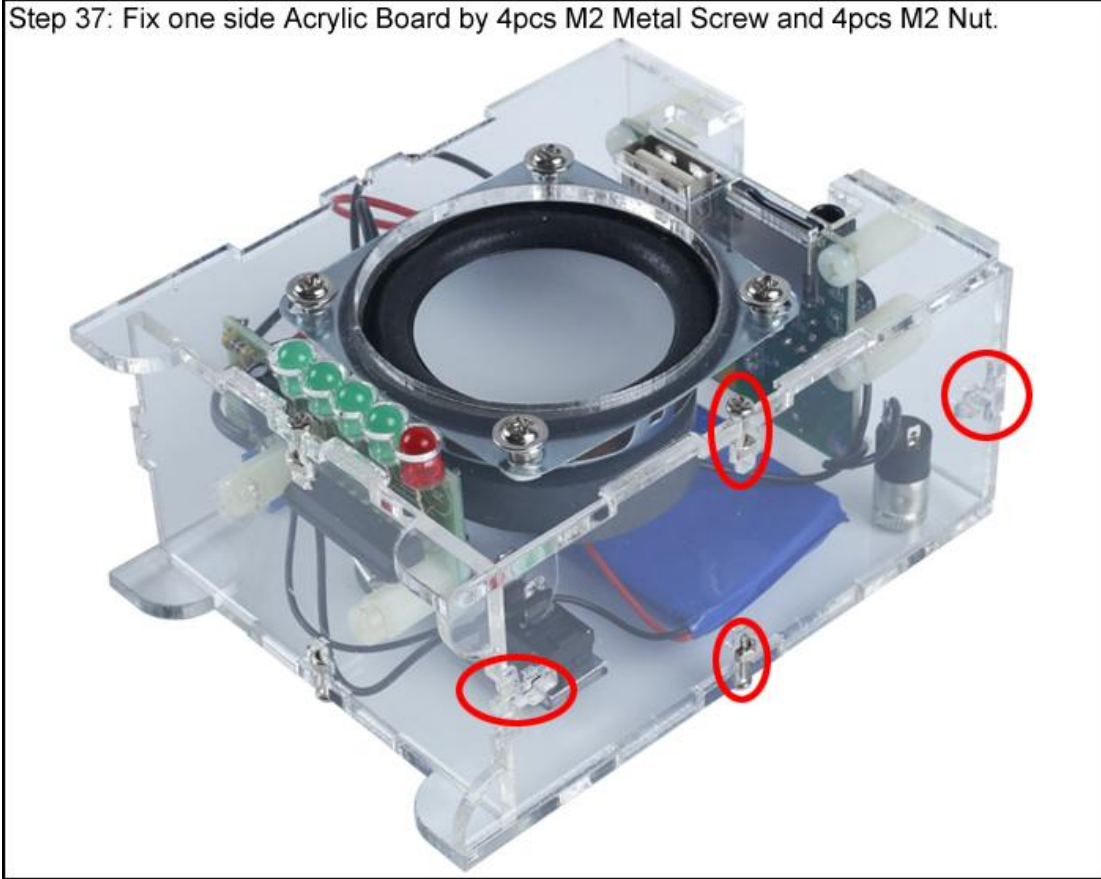

Step 38: Fix the last side Acrylic Board by 4pcs M2 Metal Screw and 4pcs M2 Nut.

