



## DIY Supercharged Bluetooth Speaker (v2.0)

by [ASCAS](#) on December 19, 2013

### Table of Contents

DIY Supercharged Bluetooth Speaker (v2.0)	1
Intro: DIY Supercharged Bluetooth Speaker (v2.0)	2
Extreme Soundtest! That Will Blow You Away! (Please wear HQ headphones. Hear the rich sound of the	2
Step 1: Parts & Materials	3
Step 2: The Acrylic Stencil Printout	4
File Downloads	4
Step 3: Sanding & Filing The Edges	4
Step 4: Cutting The Speaker's Holes (The Hard Part)	5
Step 5: Mounting Your Speakers & Radiator	6
Step 6: Sandwich The Speakers	6
Step 7: Melting Acrylic - For Side Panels	7
Step 8: Recycling Bluetooth Modules - Teardown	7
Step 9: Bluetooth Module - Hack & Mod	8
Step 10: Wiring Instructions	10
Step 11: Button, Aux & Switch Extension	10
Step 12: Mounting The Battery + Battery Upgrade	11
Step 13: Mount The Bluetooth Module	12
Step 14: Fabricating The Amplifier	12
File Downloads	13
Step 15: Installing The Amplifier	13
Step 16: Soldering The Speakers (Must Read)	14
Step 17: Sealing The Lower Panel	14
Step 18: Grinding The Edges & Sanding The Surface	15
Step 19: Paint-Job Time!	15
Step 20: Customize!	17
Related Instructables	17
Advertisements	17
Comments	17



Author:ASCAS ASCAS.com

Hello There! I'm Angelo, I was 10 when I first published my 1st ible, and started my hobby at a young age of 4. Unlike most people my friends and I have a hobby of making awesome project :D Electronics & programming is my line of specialty, that's why I compete in the annual "National Robotics Competition". Last month I manage to earn my first "Championship Title" in the NRC prelims. Not to forget that I love HiFi audio setups, just like my dad. He has his collection of B&W speakers while I design my own from scratch MDF wood. Everytime I finish a speaker, we compare it to his HiFi setup and do a blind test. Astonishingly, after putting up a blindfold my dad was not able to determine whether it was his B&W setup or my DIY Bookshelf Speakers. I love sports, specially wake boarding and basketball :D Anyways, I plan to become an engineer someday, innovating and build projects that would build a brighter future.

## Intro: DIY Supercharged Bluetooth Speaker (v2.0)

Meet AirJam, the DIY Supercharged Bluetooth speaker. Ready your tools, we are making one from scratch! The previous "DIY Bluetooth Speaker (v1.0)" had flaws so I listed all the possible improvements and built a v2.0, named AirJam. It took a lot of sweat to build AirJam (20 man hours!). If only I had a 3D printer, life would have been a lot easier :)

**Hacking & recycling helped me save money! Try to do the same :D**

### SMALL SIZE, BIG SOUND.

Despite AirJam's tiny size, it has the ability to surpass its competitor's performance. Thanks to the sandwiched speaker orientation, I was able to fit 4 Full-ranged speaker drivers in one tiny enclosure (2x7x2"). A "passive radiator" was added to extend the lower bass frequencies, thus resulting to a much punchier bass. Compared to its rivals, the AirJam has 4 active drivers and one passive radiator, offering deeper bass and wider mids.

### CHANGE TRACKS WIRELESSLY (works with Siri!)

Thanks to Bluetooth 4.0, AirJam can receive Bluetooth transmissions up to 30 meters! Whether you are using your laptop, tablet or phone, you can easily switch tracks wirelessly. The handsfree feature works great with Speakerphone, Skype, FaceTime and also Siri!

### That design looks familiar! Humm... Where did it come from?

I got my design from Bose's state of the art masterpiece, the Sounlink Mini. My dad gave me one for Christmas. If you would ask me: what's the best compact Bluetooth speaker in market? It's definitely Bose's Soundlink Mini! The only downside is the price, tagged at \$199, it's not the average speaker that an average man would buy.

If you remember reading my bio, you would recall that I love making DIY versions of existing HiFi products. The teardown is my favorite part since you get to learn engineer's secret on building their product's success. Luckily I didn't need to tear my Sounlink down since a lot of resources were cited online.

### Specs & Features:

- Includes Handsfree Microphone (Speakerphone Function)
- Quad 3W Fullrange Speakers (4? - 35mm drivers)
- Quad 3W High Efficiency Amplifier (class AB)
- Li-Po Battery 1,300mAh (20hrs Playback)
- Command Buttons (Volume/Pause//Play)
- Tested dB (via SPL): 96dB @2ft
- 30m Bluetooth Range (v4.0)
- Single Passive Radiator
- 3.5mm Auxiliary Ready

### Videos Comming Soon (after my condenser mic arrives):

- AirJam Professional Add (Business Proposal)
- AirJam vs. Bose Soundlink Mini
- AirJam vs. Jawebone Jambox
- AirJam vs. JBL Charge & Flip

### Extreme Soundtest! That Will Blow You Away!

**(Please wear HQ headphones. Hear the rich sound of the SUPERCHARGED speaker)**

High Efficiency Amplifier Test (Prototyping Stage)

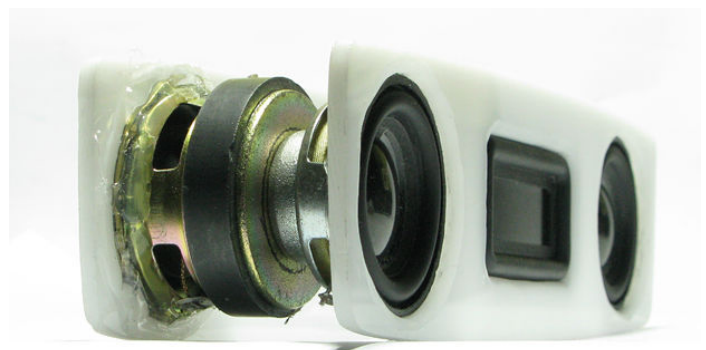

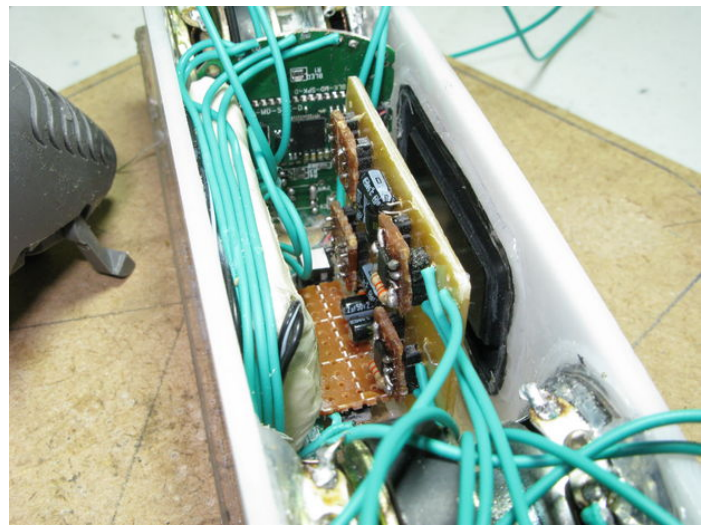

## Step 1: Parts & Materials

### Parts, Modules & Materials:

- Bluetooth Speaker (for teardown) -- [1x \$7.60]
- 35mm Speakers (3W - 4ohms) -- [4x \$2.80]
- 1Cell LiPo Battery (3000mAh) -- [1x \$8.70]
- Acrylic Board (0.4mm thick) -- [1x \$5.00]
- 8002B Audio Amp I.C. (3W - 3?) -- [4x Recycled]
- 2.2uF Electrolytic Capacitor -- [4x local store]
- 10K? Resistor (1/4w) -- [4x local store]
- 33K? Resistor (1/4w) -- [4x local store]

### Similar Alternatives (Read The Guide First):

- Bluetooth Speaker (for teardown) -- [1x \$12.60]
- Efficient 3W+3W Stereo Amplifier -- [2x \$2.90]
- LiPo Battery Charging Module -- [1x \$10.50]

### Tools & Equipment:

- Rotary Tool (ex. Dremel)
- Leatherman Multitool
- Portable Drill
- Metal File



## Step 2: The Acrylic Stencil Printout

Print the stencil provided by the link below. Carefully cut the stencil with a pair of scissors then trace the edges using a neon colored highlighter. Why use a highlighter? It's a lot easier to see when you are grinding and filing the edges.

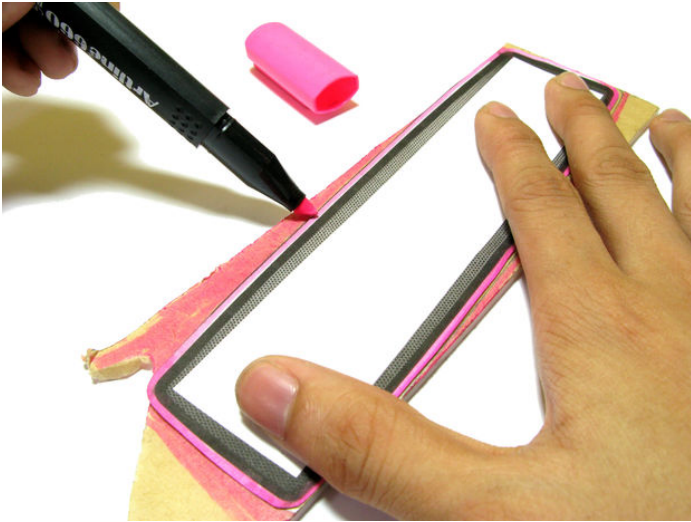

## File Downloads



Printable Stencil Outline.pdf (124 KB)

[NOTE: When saving, if you see .tmp as the file ext, rename it to 'Printable Stencil Outline.pdf']

## Step 3: Sanding & Filing The Edges

You might want to get your rotary tool for sanding and grinding the larger chunks of acrylic. When the highlighted area gets thinner, start using your old metal file.

**Be careful, if you cut too much acrylic, you will have to repeat the whole process!**

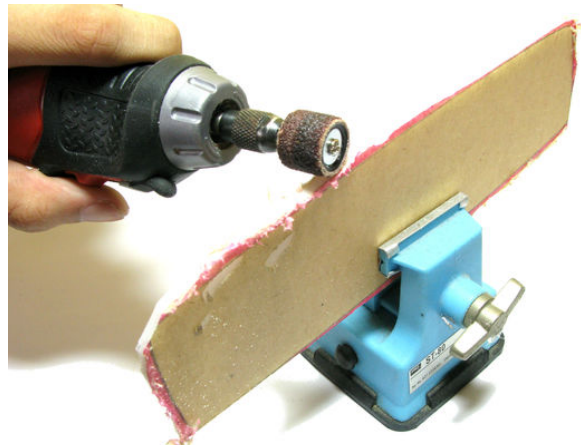

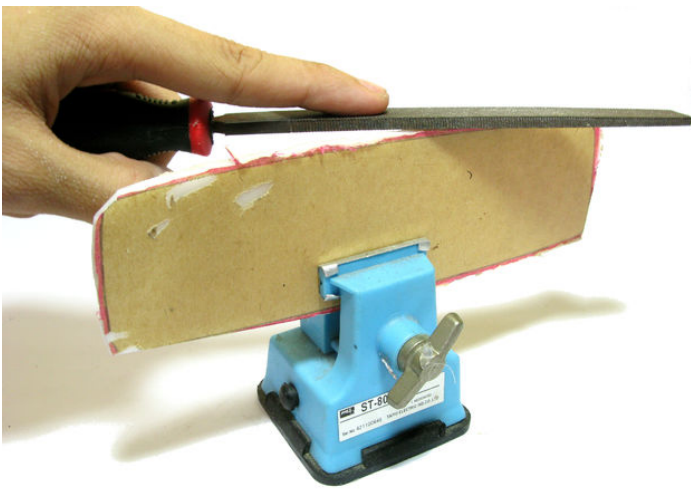

#### Step 4: Cutting The Speaker's Holes (The Hard Part)

Ohh no! It's time to cut the holes. I know how you feel. Luckily there's a technique to cleanly cut circular holes.

- 1st.) Again, use your highlighter pen to trace out your speaker's edges
- 2nd.) Attach your grinding tip for your rotary tool then cut off the excess acrylic.
- 3rd.) Get your sanding drum tip then sand off the remaining pink marks.
- 4th.) Finally, bevel the edges. This helps spread the higher audio frequencies given off by the speakers.

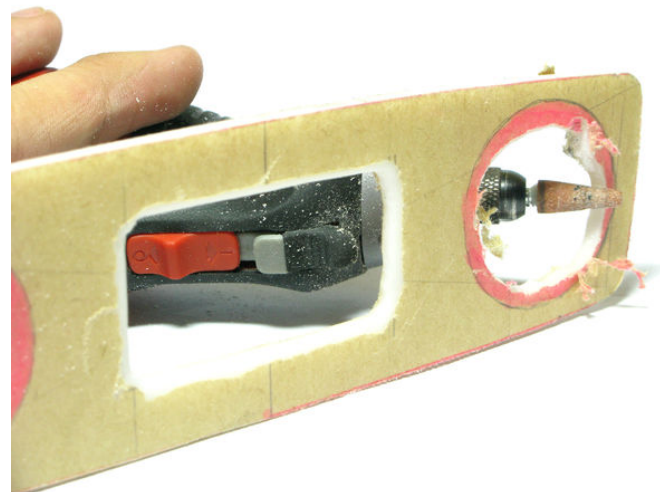
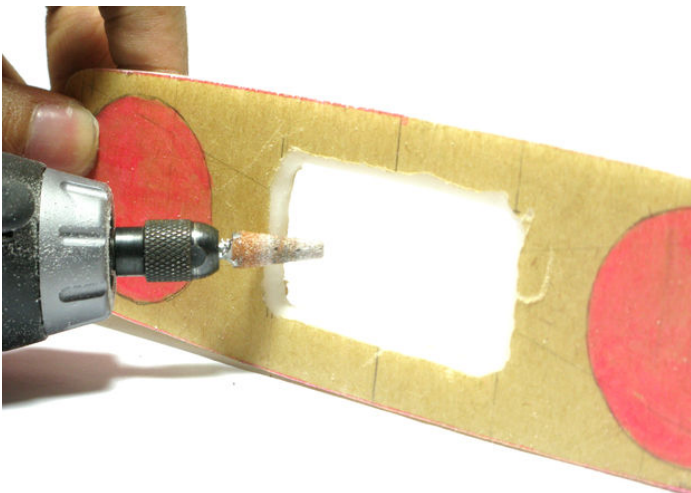
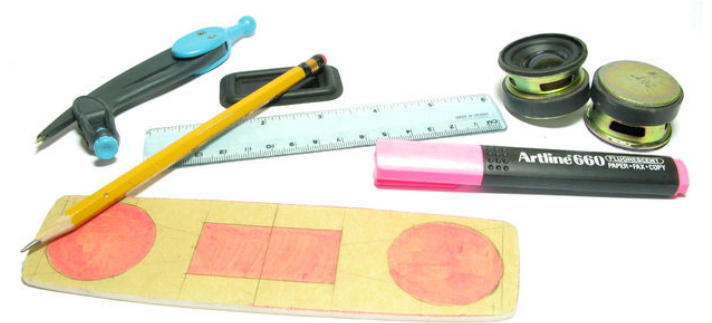

### Step 5: Mounting Your Speakers & Radiator

Okay, this part is crucial. In order to achieve that punchy bass performance, you must keep your BT speaker 100% airtight. Apply enough amounts of superglue on the acrylic's surface (speaker area) to ensure that you have sealed the gaps. Apply minute amounts of hot glue around the passive radiator & speaker drivers.

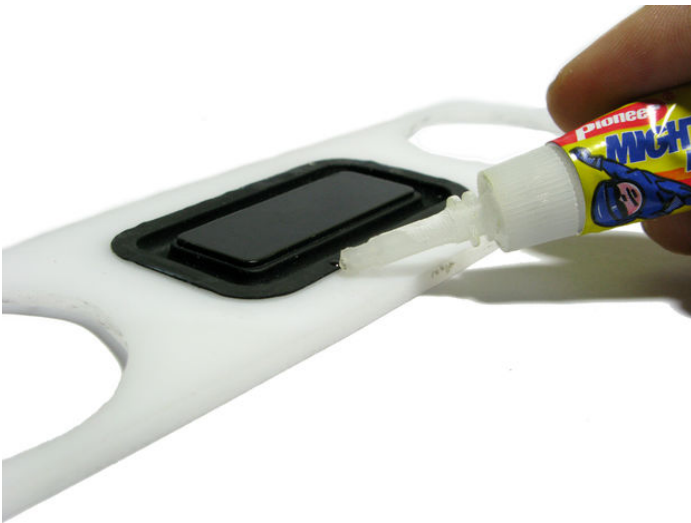
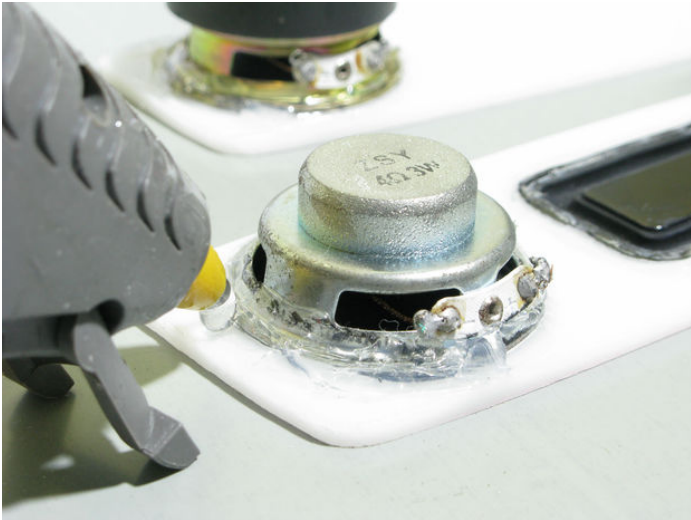

### Step 6: Sandwich The Speakers

The side panels are not yet done. For now, the speaker's will act as the temporary foundation. Since both panels are completely congruent the speakers are also located at the same area (back to back). Use epoxy or superglue to bind them.



### Step 7: Melting Acrylic - For Side Panels

I started off by supergluing the top panel then soften the acrylic by heating it with our kitchen stove. Don't forget, we still have to install our electronic components. We still have leave the lower panel open.

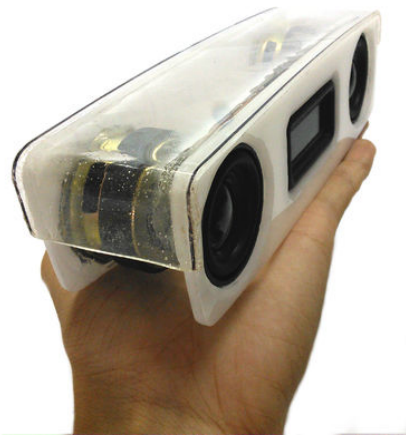

### Step 8: Recycling Bluetooth Modules - Teardown

Here's the thing. I recently found a cheap Bluetooth speaker from our local gadget store, bought it for around 380php (\$7.60). She's a real bargain! If you disassemble four of these, chances are you would end up recycling four 8002B amplifier chips (that's what I'm using).

#### Ordering a Cheap Bluetooth Module:

- Price range is around: \$8 -22
- You only get the BT module itself

#### Ordering a Cheap Bluetooth Speaker:

- Microphone (Handsfree Function)
- Price range is around: \$7-12
- 3W Speaker (35mm)
- Command Buttons
- 3W Amplifier Chip
- 3.7v Li-ion Battery
- Bluetooth Module

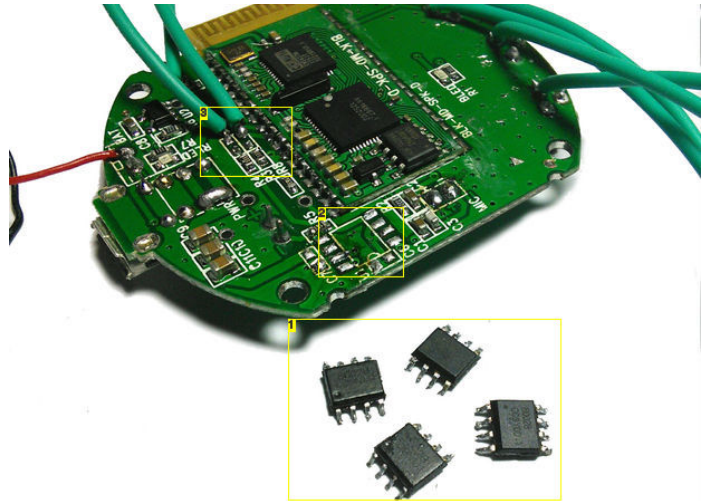
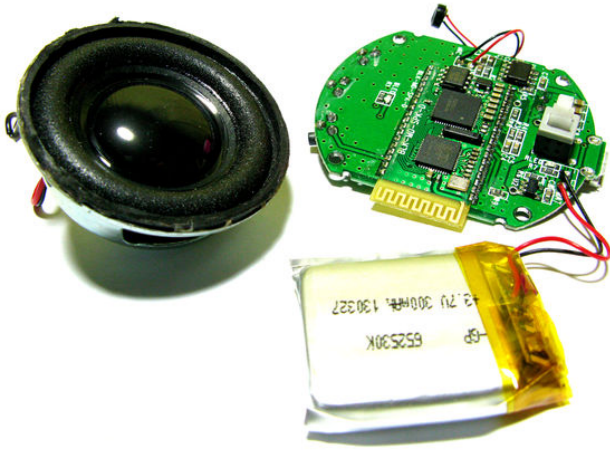

**Image Notes**

1. These came from my other disassembled BT speakers. These are 3w amplifier chips
2. You won't be needing that IC amp
3. The Mod

**Step 9: Bluetooth Module - Hack & Mod**

One can easily say that our previously torn-down BT speaker has a mono channel. We need stereo channels not mono, so are going to hack and mod the BT module. To do this, you must remove the capacitor pairs that are connected from your main BT module going to the mono amp IC, then replace them with wires (as seen on the photo).

If you end up finding a different BT module, research its model and track down the L & R audio pins.

- I researched My Module's Parts:**
- Speaker: 3W Neodymium (35mm - 4ohms)
  - Lithium Charger Chip: UN8HX
  - BT Model: BLK-MD-SPK-D
  - 3W Amplifier Chip: 8002B



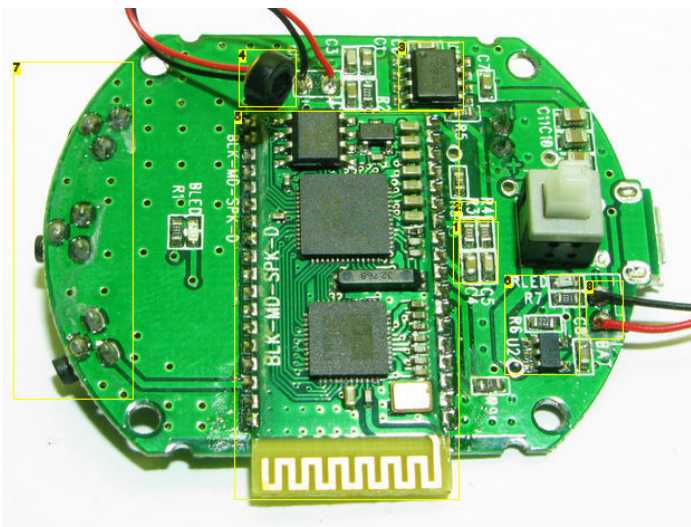

**Image Notes**

1. See these things? These are resistor and capacitor pairs. The BT's audio output goes out here.
2. Both resistors join a junction here. This combines both channels to form a Mono configuration for the mono amplifier.
3. The 3W Mono amplifier, we need to recycle four of those.
4. Mini Microphone for headset.
5. The main Bluetooth module.
6. The lithium charge controller circuit.
7. The command buttons. We need to extend those!
8. This goes to the 3.7v Lithium Battery.

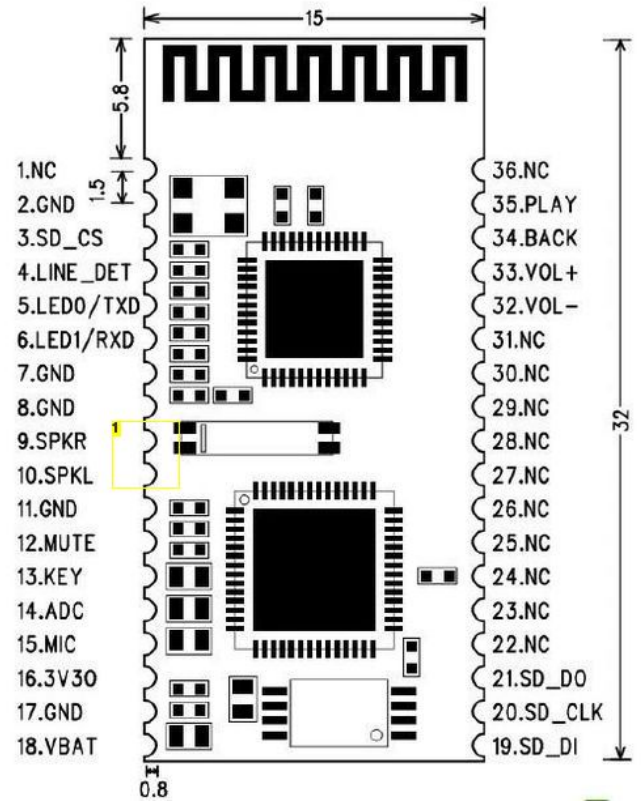

**Image Notes**

1. Find these pins and connect wires for each channel, leading to your amp's input.

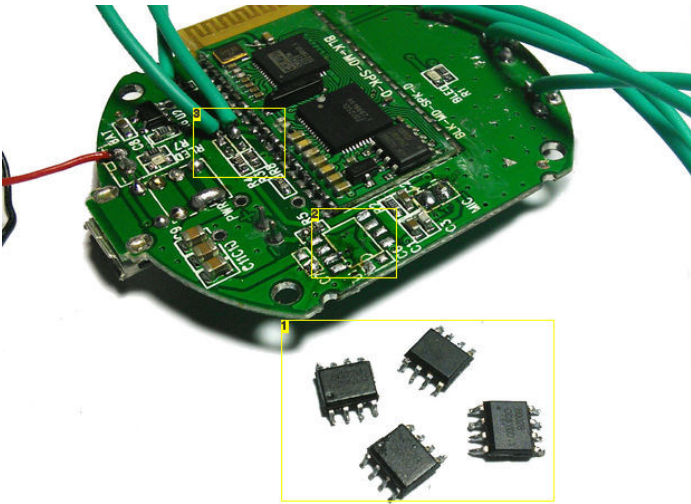
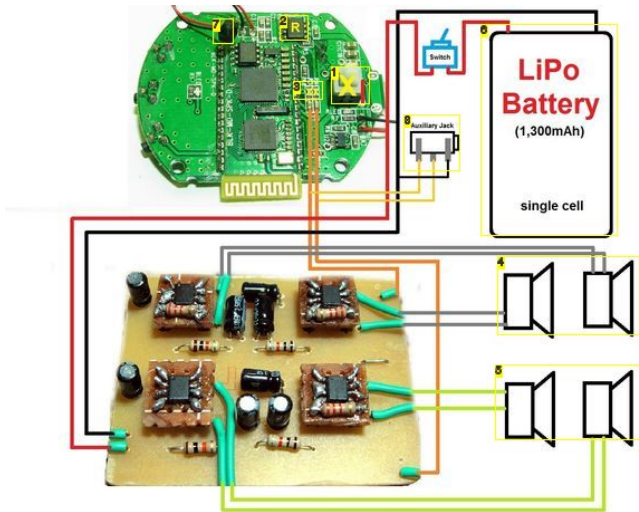

**Image Notes**

1. These came from my other disassembled BT speakers. These are 3w amplifier chips
2. You won't be needing that IC amp
3. The Mod

## Step 10: Wiring Instructions

Here's a simple wiring diagram. Please read the image notes.



### Image Notes

1. Desolder the switch and solder a jumper to complete the circuit.
2. Refer to Step #9
3. Desolder those useless SMD resistors! :))
4. Left Speakers
5. Right Speakers
6. Lithium Battery Upgrade.  
Read Step #12
7. Microphone for speakerphone function
8. Standard Aux Jack

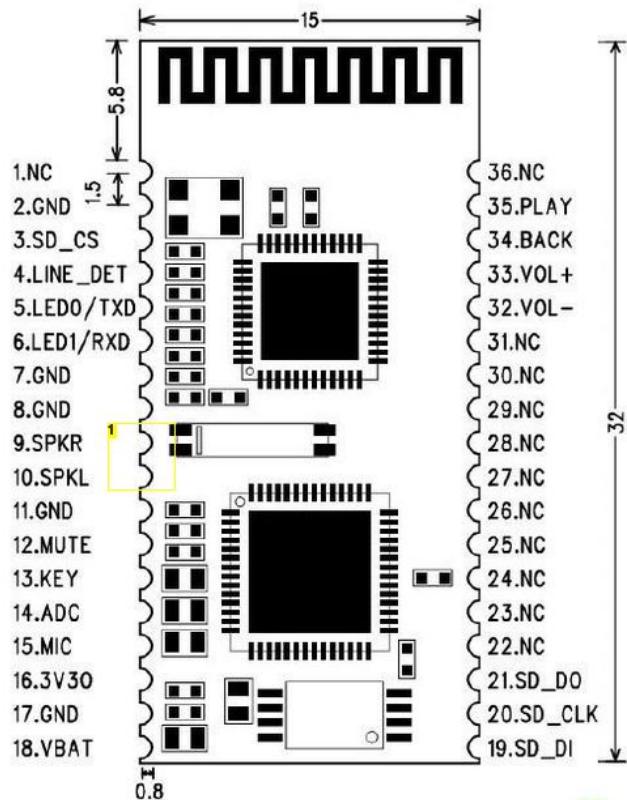

### Image Notes

1. Find these pins and connect wires for each channel, leading to your amp's input.

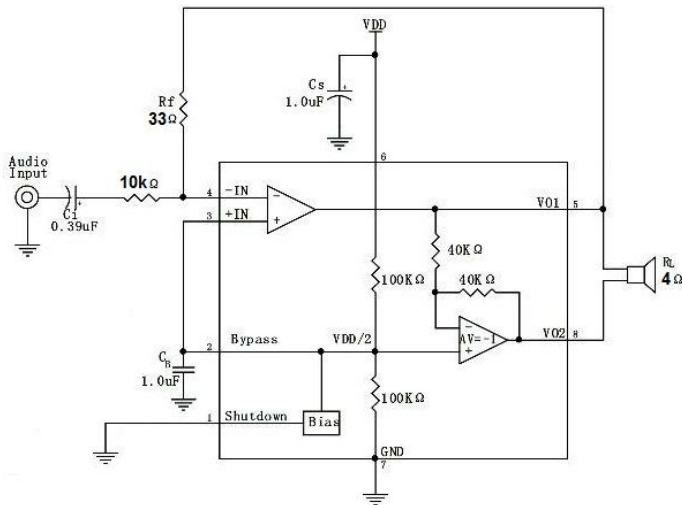

## Step 11: Button, Aux & Switch Extension

- 1st.) Simply extend the buttons from your BT module to your speaker's enclosure.
- 2nd.) The aux, must be connect parallel to the BT module's audio output.'
- 3rd.) Make the enclosure more airtight by filling the button gaps with hot glue.

### What's the perf board for? How do I assemble it?

Well there's nothing fancy or complicated about this step. I just mounted the tact switches on a perf board for the wires to be organized. Just extensions.

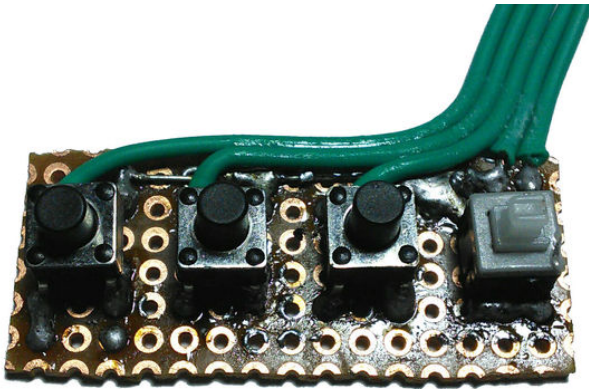
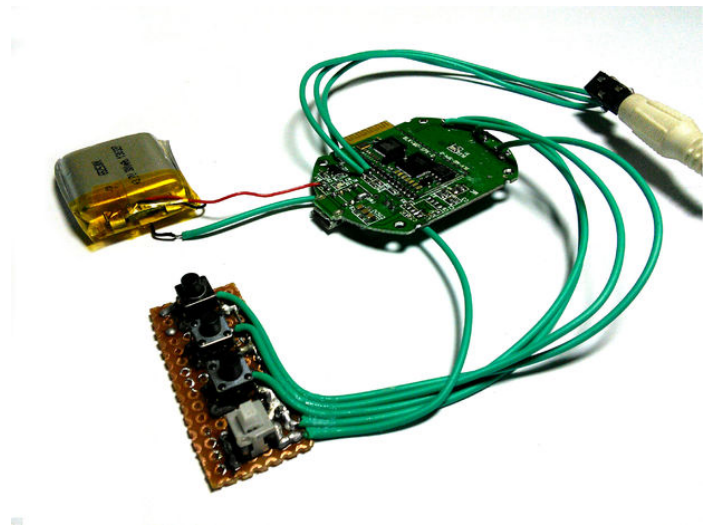
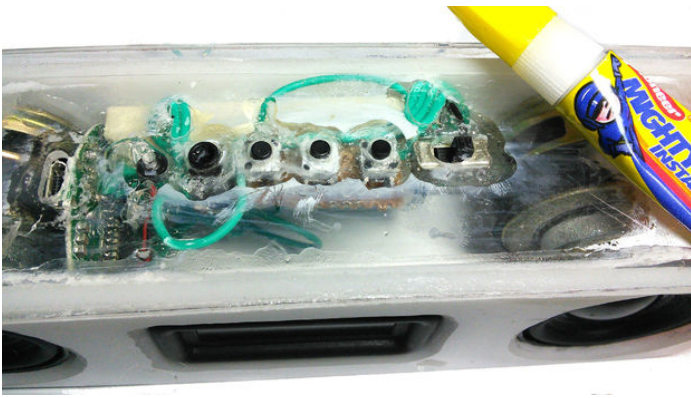

### Step 12: Mounting The Battery + Battery Upgrade

I upgraded the 300mAh Lithium Ion battery (stock) with a much longer lasting 1,300mAh Lithium Polymer. Remember LiPo batteries last 4x longer compared to Li-ion batteries (in terms of size).

The BT module came with a Lithium charging circuit. Don't worry it still works with the larger LiPo battery. The charger's auto cut-off is based on the battery's voltage and not on the current. So in terms of compatibility, the charger would still work with the LiPo, but in a much slower way.

#### Speaker's Tested Battery Life:

- Bedroom Listening (low = 20 hours)
- Living Room (medium = 12 hours)
- Party Outdoors (max = 6 hours)

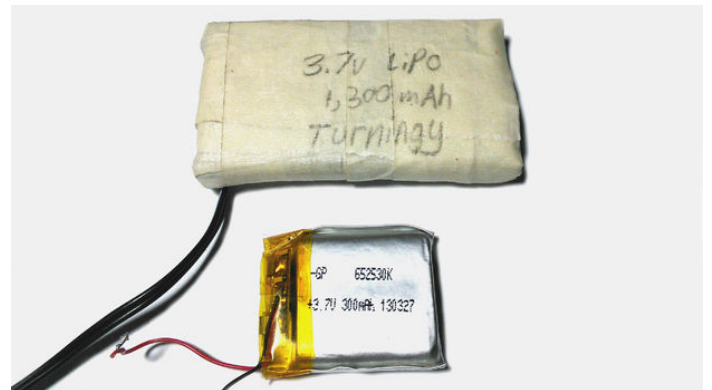
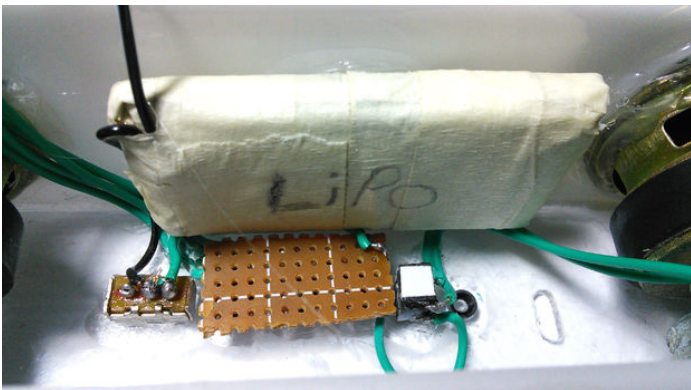

### Step 13: Mount The Bluetooth Module

Before you hotglue the BT module to your speaker's enclosure, be sure to drill a hole for the BT module's micro USB plug.

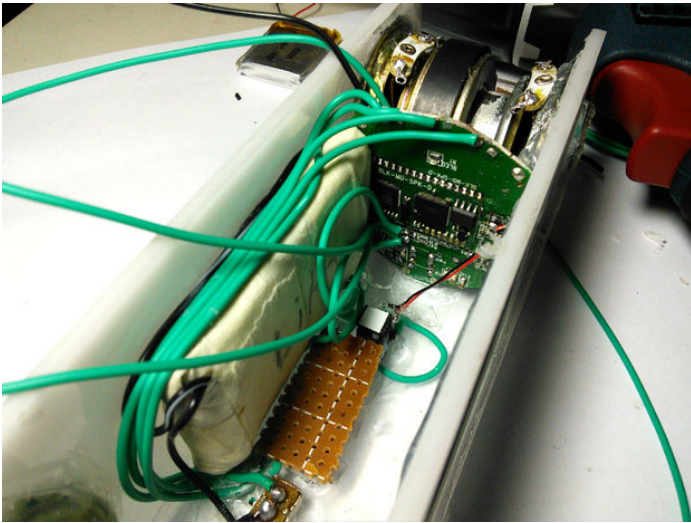

### Step 14: Fabricating The Amplifier

Have you decided, whether you should buy two "2x3W Amplifier Modules " or make one for yourself? If you don't have four 8002B chips, then better go with the ready made amp module. They only cost \$2.90 each, plus dx.com ships them for free!

If your a Bluetooth speaker addict and has salvaged more than three BT speakers, then chances are you have four 8002B chips waiting for you to recycle. If you've managed to find four of those chips then, you could start making the PCB. I provided a downloadable PCB layout with fixed dimensions. The schematic will explain the part's value.

**Convert SMD Chips To DIP:** Read My Guide  
**My Full PCB Tutorial:** DIY Customized Circuit Board

Mono Amplifier DEMO - Breadboard Prototype

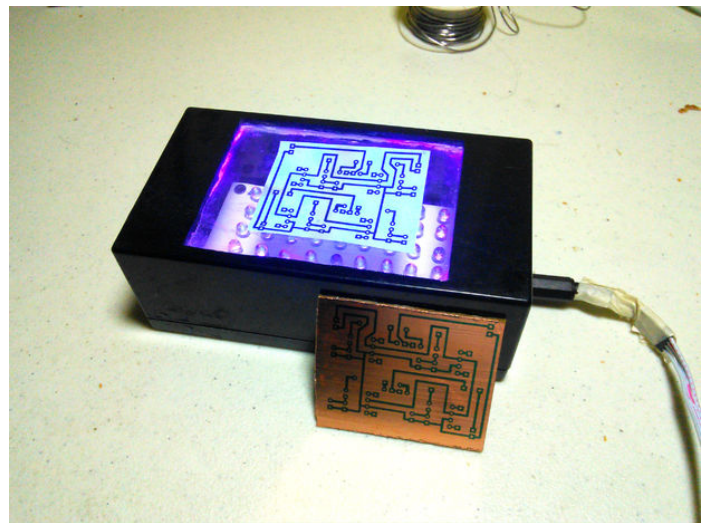
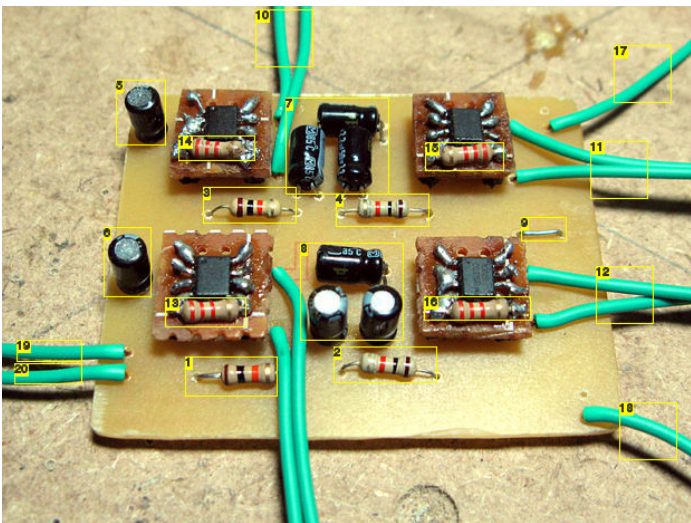

#### Image Notes

1. 10k Ohm Resistor (1/4w)
2. 10k Ohm Resistor (1/4w)
3. 10k Ohm Resistor (1/4w)
4. 10k Ohm Resistor (1/4w)
5. 2.2uF Electrolytic Capacitor
6. 2.2uF Electrolytic Capacitor
7. 2.2uF Electrolytic Capacitors
8. 2.2uF Electrolytic Capacitors
9. Jumper
10. Rear Right Speaker
11. Front Right Speaker
12. Front Left Speaker
13. 33k Ohm Resistor (1/4w)
14. 33k Ohm Resistor (1/4w)
15. 33k Ohm Resistor (1/4w)
16. 33k Ohm Resistor (1/4w)

- 17. Right Channel
- 18. Left Channel
- 19. Ground (-)
- 20. 3.7 Volts

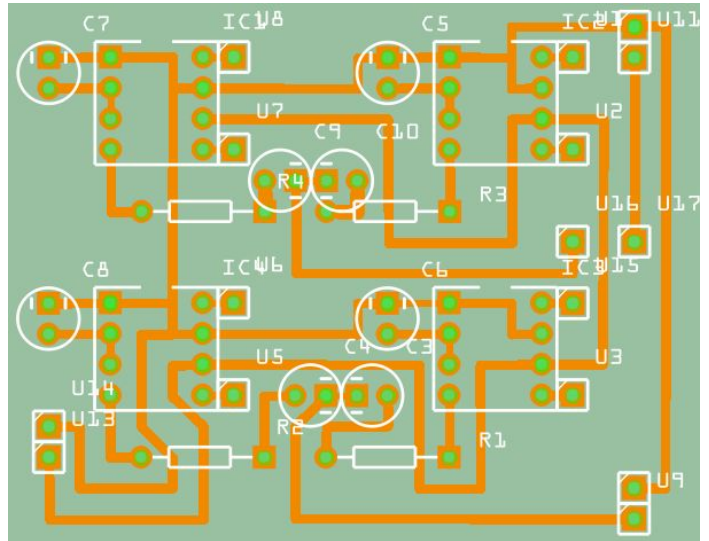
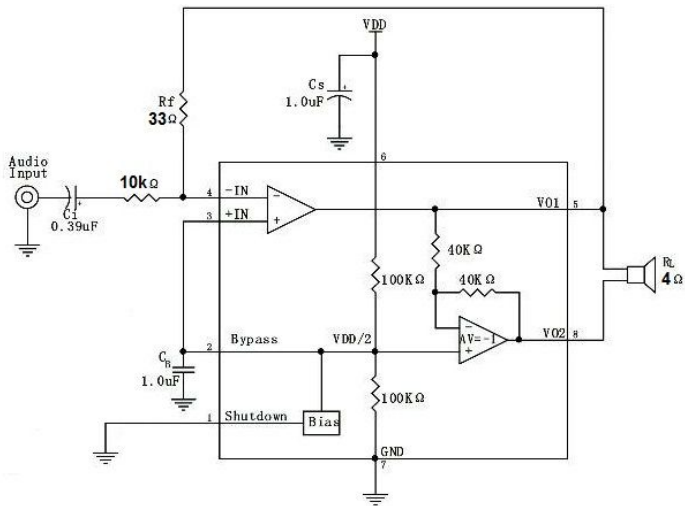
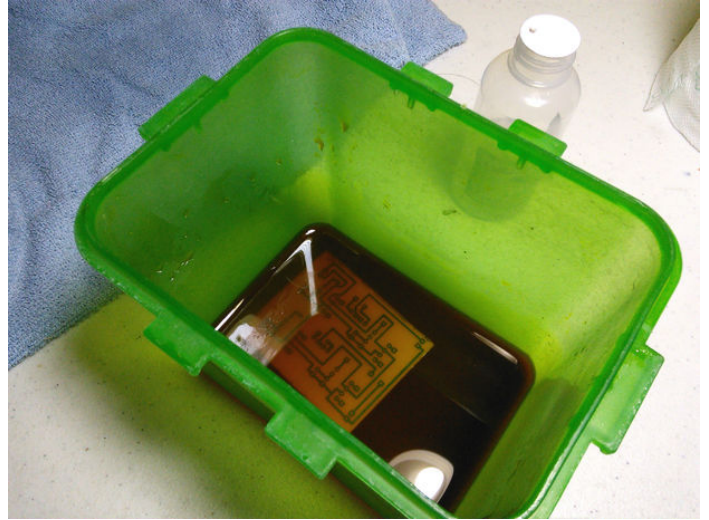
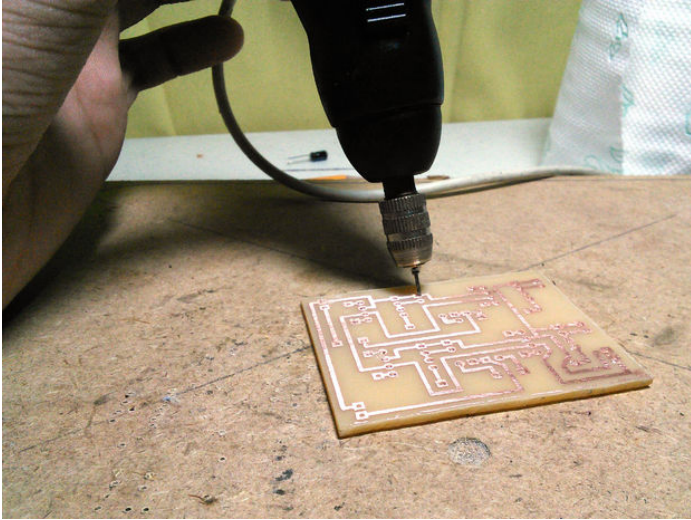

**File Downloads**

 [4x3W Amplifier PCB Layout \(8002B\).pdf](#) (4 KB)  
 [NOTE: When saving, if you see .tmp as the file ext, rename it to '4x3W Amplifier PCB Layout (8002B).pdf']

 [8002B Amplifier Datasheet.pdf](#) (712 KB)  
 [NOTE: When saving, if you see .tmp as the file ext, rename it to '8002B Amplifier Datasheet.pdf']

**Step 15: Installing The Amplifier**

Hot glue the amplifier in place, make sure it does not touch the "passive radiator". The wiring instructions can be found in Step #10. Goodluck!

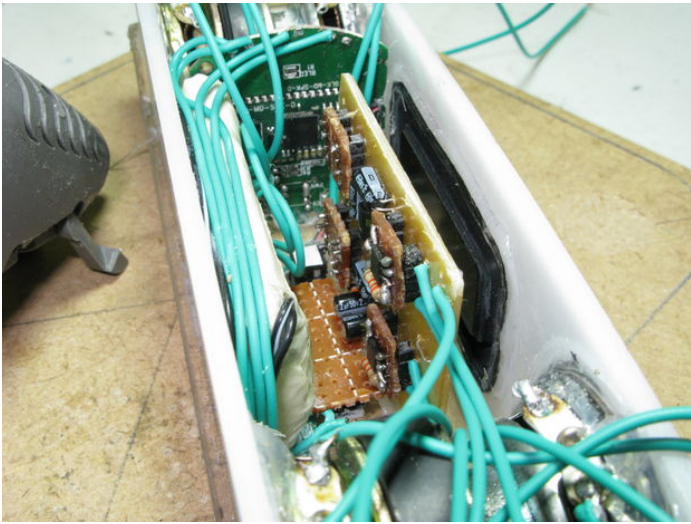

### Step 16: Soldering The Speakers (Must Read)

The pin-5 of the I.C. goes to the speaker's negative terminal, while the pin-8 goes to the positive terminal. Polarity must be observed properly, otherwise all the speakers will cancel each other.

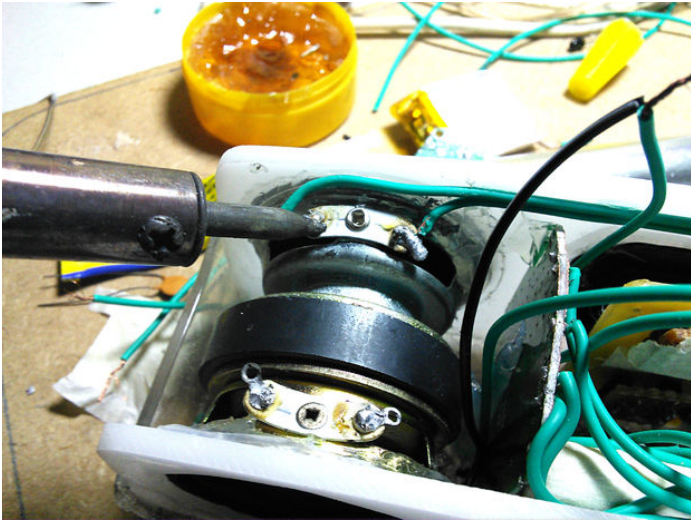

### Step 17: Sealing The Lower Panel

Finish off the airtight enclosure by repeating Step #7, but this time, we are melting acrylic of the lower panel.



### Step 18: Grinding The Edges & Sanding The Surface

Use your handy rotary tool to grind off those sharp protruding edges. Don't stop until you achieve a flat surface. Remember, the superglue used to bind the acrylic works as a filler (putty). It hides the gaps after sanding.

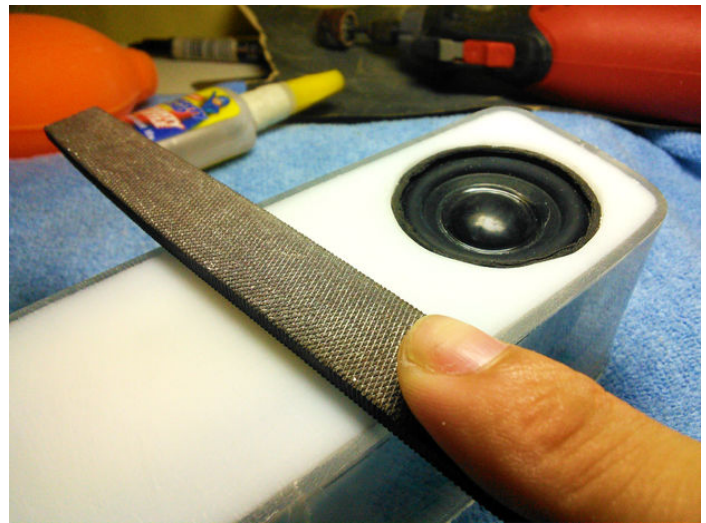

### Step 19: Paint-Job Time!

Now for my favorite part. Express yourself with colors! I gave mine a two-toned finish (The famous "Black & Yellow" :D)

#### My Steps (You Could Do Your Own Steps):

- 1st.) Stuff your Auxiliary Jack, Mic and Switch with tissue paper.
- 2nd.) Cover the front baffle panel with masking tape.
- 3rd.) Paint the side panels with a can of "Matt Black Spray Paint"
- 4th.) Cover the side panels with masking tape.
- 5th.) Paint the side panels with a can of "Glossy Yellow Spray Paint"
- 6th.) Let it dry under the sunlight for 2 hours.
- 7th.) Unmask the tape.

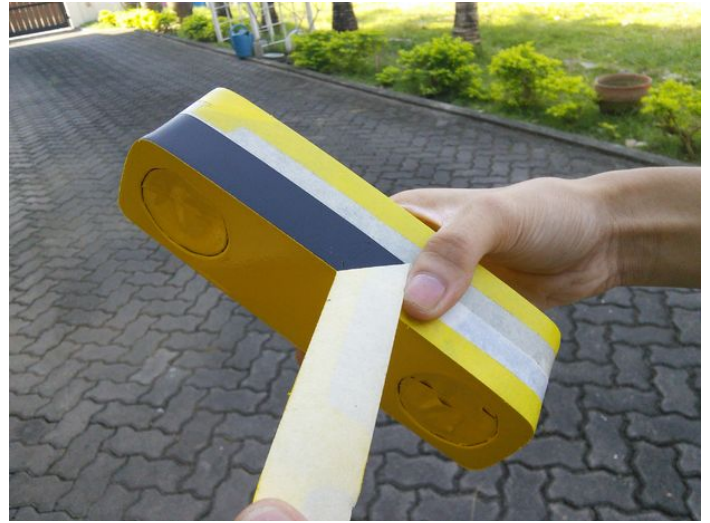



## Step 20: Customize!

Ok, now that we are done. Let us start customize our "AirJam" with anything! Adding vinyl stickers, painting stripes, laser cutting texts, you name it, let your imagination run wild!

### Suggestions (give me more guys!):

- Use Sugru to make AirJam's rubbery legs, it reduces vibrations. (The future needs fixing!)
- If you have an iPhone, play with Siri! AirJam talks back to you! :D
- Replace the dustcaps with parabolic plastics (makes it look better)
- Try to find a cheap AirPlay module (loss-less wireless audio)

Hey guys! I'm glad to inform you that we are building 3 more Bluetooth speakers this year! If you guys like it, your single **vote** would mean a lot to me! Thanks for visiting! Enjoy your AirJam!



## Related Instructables



**DIY Bluetooth Speaker** by ASCAS



**Convert SMD Chips to DIP (Breadboard Friendly)** by ASCAS



**DIY 70's Style Headphone Bluetooth Modification** by andrewwayneisbor



**Macbook 13" Repair - Speaker and Bluetooth Removal (video)** by powerbookmedic

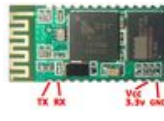

**Cheap 2-Way Bluetooth Connection Between Arduino and PC** by techbitar



**DIY RC Android Sumobot [Bluetooth Multiplayer]** by ASCAS

## Comments

10 comments [Add Comment](#)



**metalix** says:

what is the rubber thing between the speaker used for

Dec 30, 2013. 11:27 PM [REPLY](#)



**ASCAS** says:

It's called a "Passive Radiator", also known as a passive membrane. As stated above, it's used to extend the lower audio frequencies given off by the speaker (gives deeper bass). It's a good replacement for bass ports.

Dec 30, 2013. 11:31 PM [REPLY](#)



**lumpyloUIS** says:

Sorry, another question: Did you have to introduce a boot loop isolator since you are running the Bluetooth module and amps off of the same power source? I have heard that this introduces interference without one.

Dec 30, 2013. 9:41 AM [REPLY](#)



**lumpyloUIS** says:

\*ground loop, not boot loop. whoops

Dec 30, 2013. 12:55 PM [REPLY](#)



**ASCAS** says:

Nope it does not, the amp has built in filter capacitors, they filter the noise. Wait for the ible to be published tomorrow. I will provide the wiring diagrams :))

Dec 30, 2013. 10:03 AM [REPLY](#)



**lumpyloUIS** says:

Dec 30, 2013. 9:30 AM [REPLY](#)

ASCAS, thanks so much for this instructable. I have been looking for a passive radiator (PR) bluetooth build forever. This is the first ive found and it looks awesome! Couple of questions. Did you do any type of volume measurements for your driver/PR/amp combo? That single PR seems small for 4 35mm drivers. Do you have any other suggestions on sourcing the PR? It doesnt look like that boat is available inthe US.

---



**tekletowner** says:

Dec 30, 2013. 1:57 AM [REPLY](#)

Great Job! Will you be adding a downloadable PDF of this?

---



**ASCAS** says:

Dec 30, 2013. 5:30 AM [REPLY](#)

Yup! LOL you're the 1st to comment, the guide is not yet published :)

---



**tekletowner** says:

Dec 30, 2013. 6:38 AM [REPLY](#)

What are dimensions of just the PCB? The one you purchased

---



**tekletowner** says:

Dec 30, 2013. 6:10 AM [REPLY](#)

lol

---