

H-1

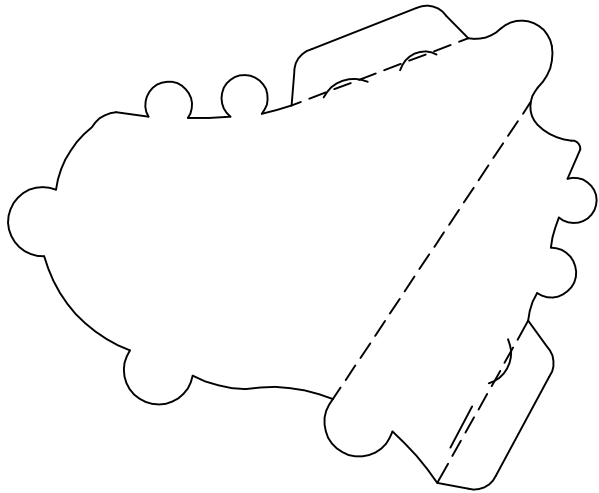

H-2

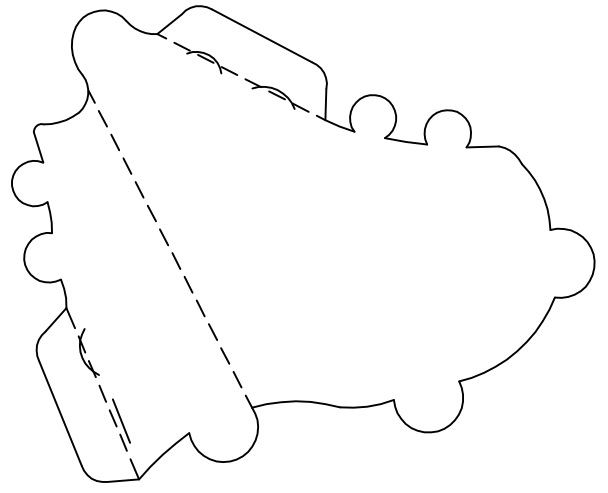

H-3

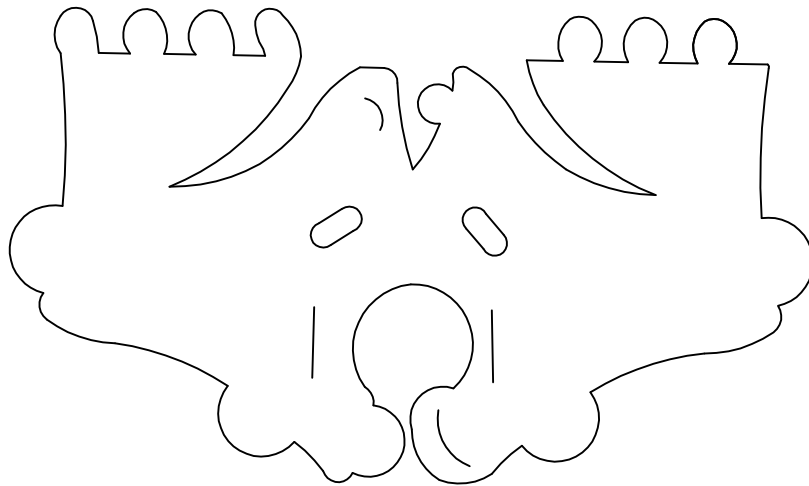

H-4

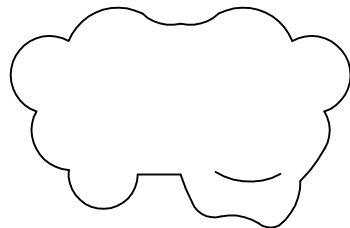

Cut _____
 Valley-fold - - - - -
 Mountain-fold - - - - -

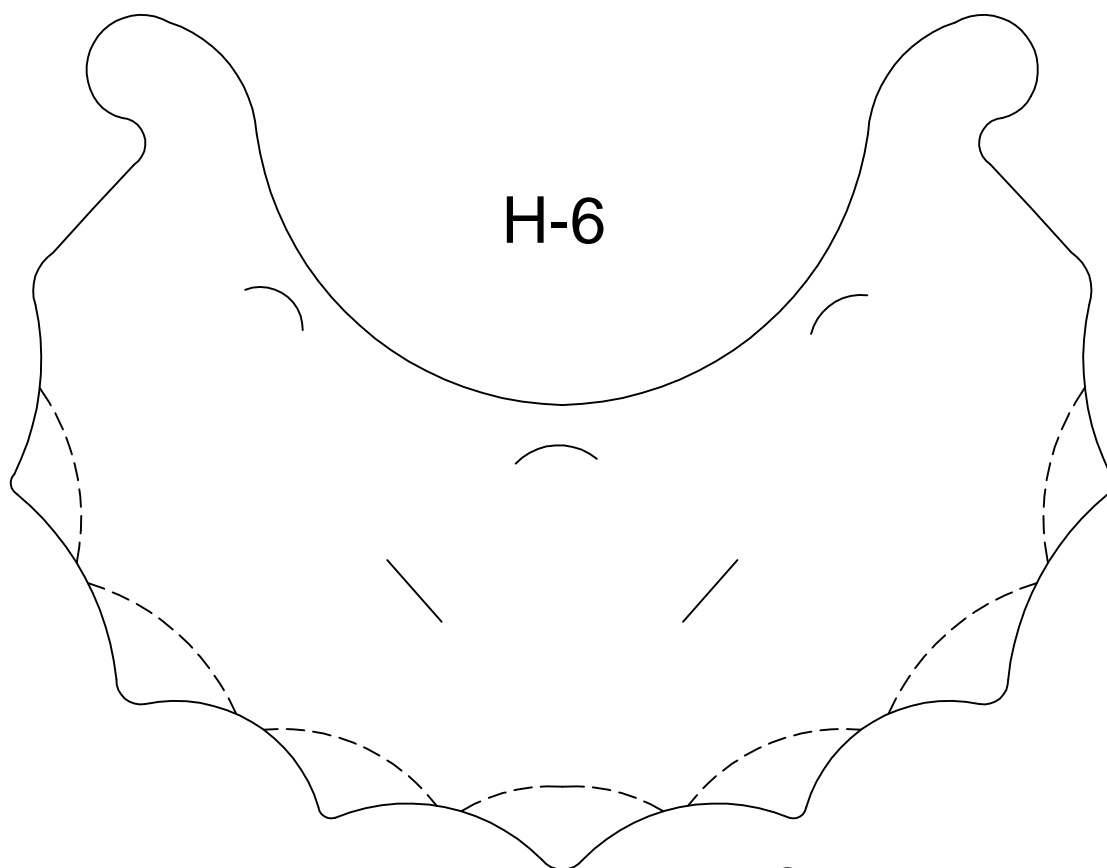
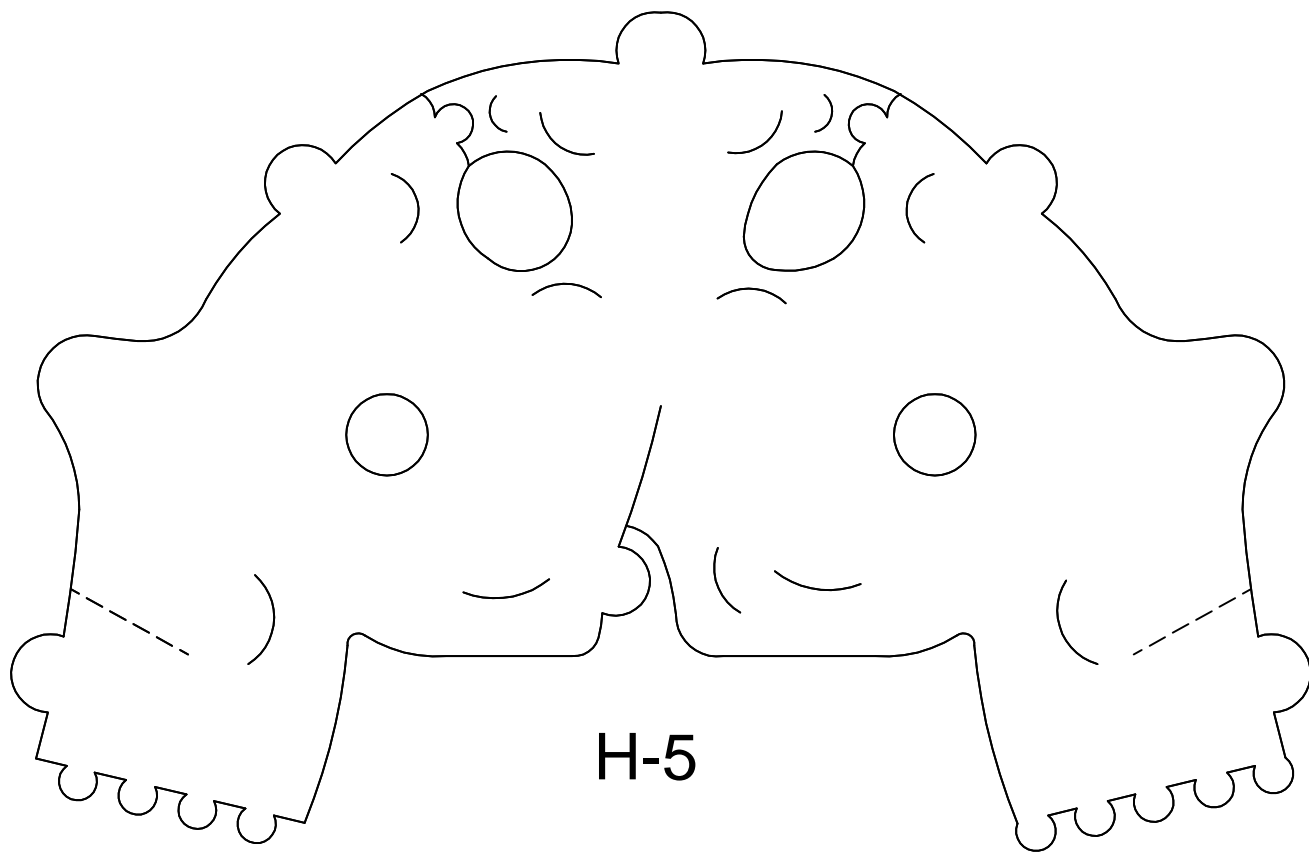

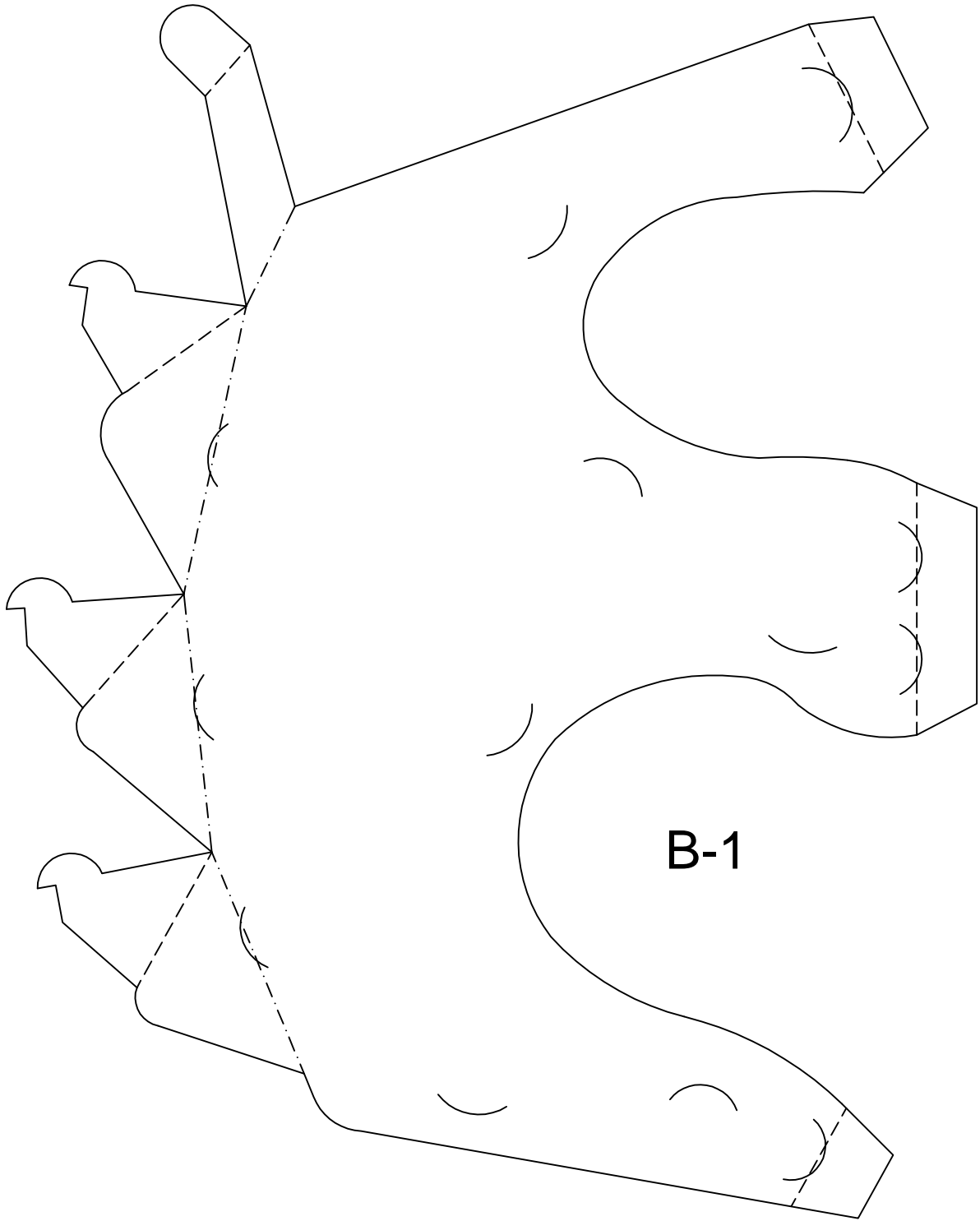

B-1

B-2

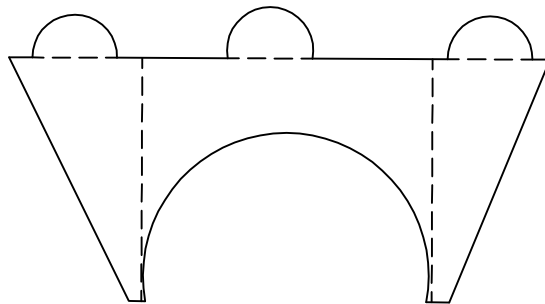

Cut
 Valley-fold
 Mountain-fold

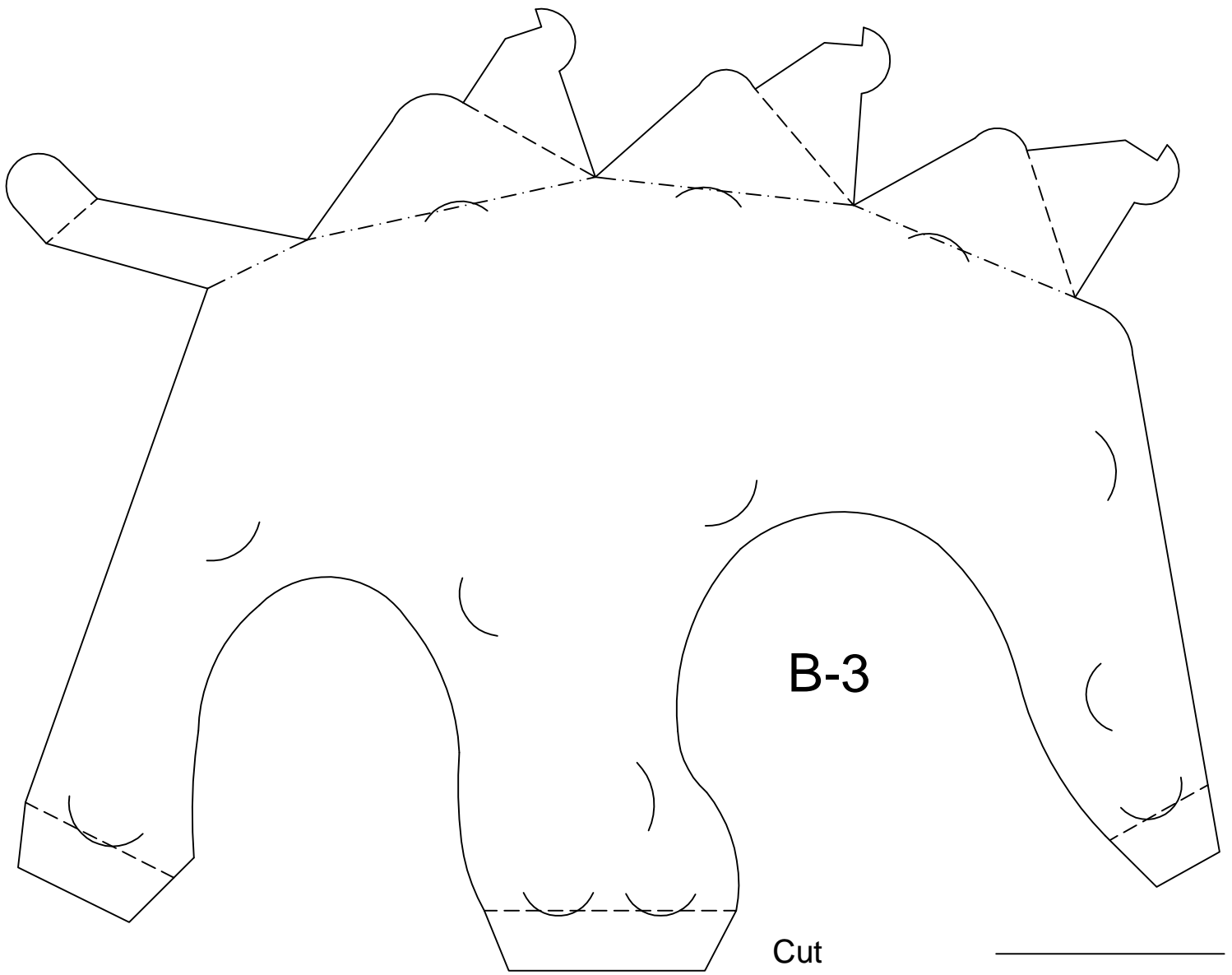

B-3

Cut _____
Valley-fold - - - - -
Mountain-fold - - - - -

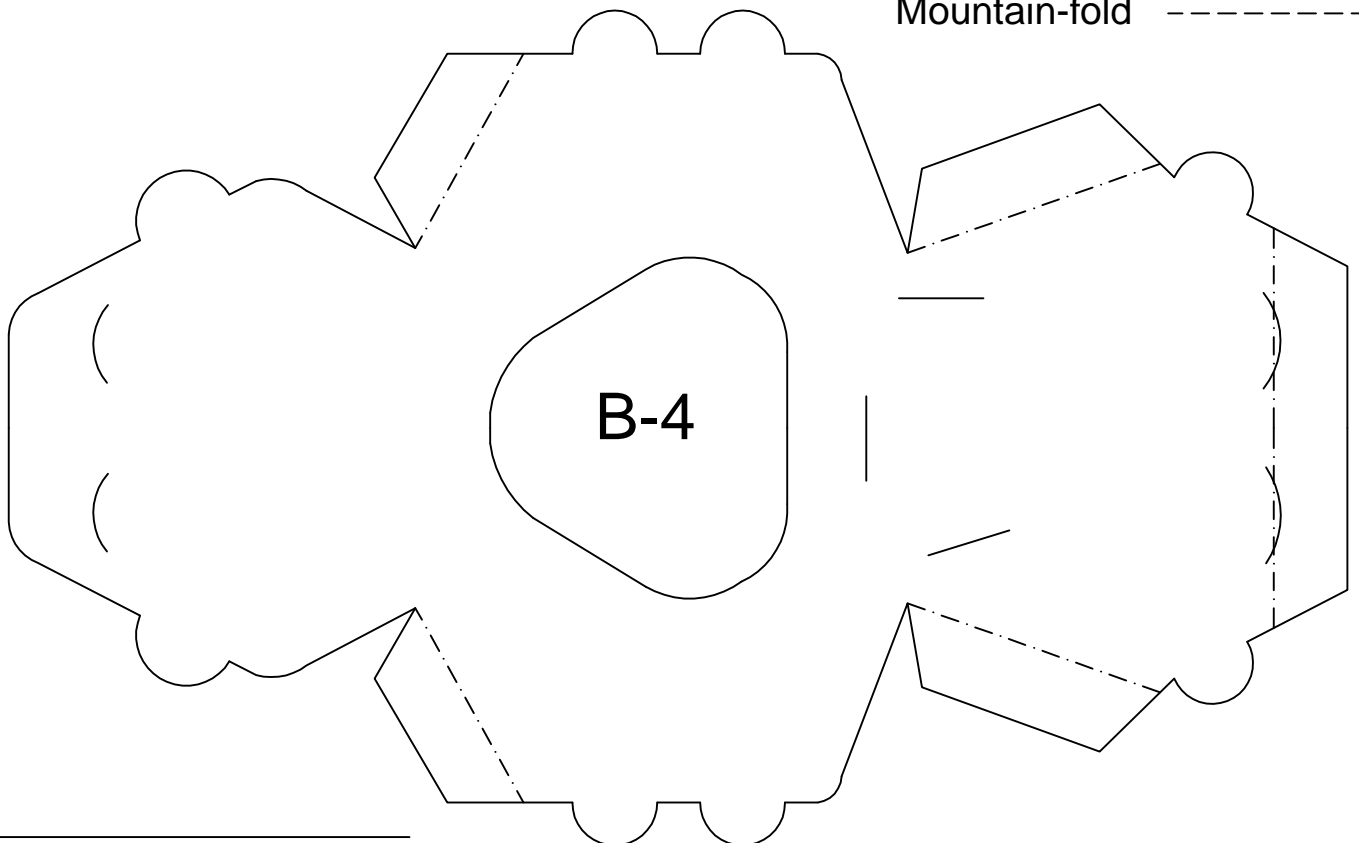

B-4

L-1

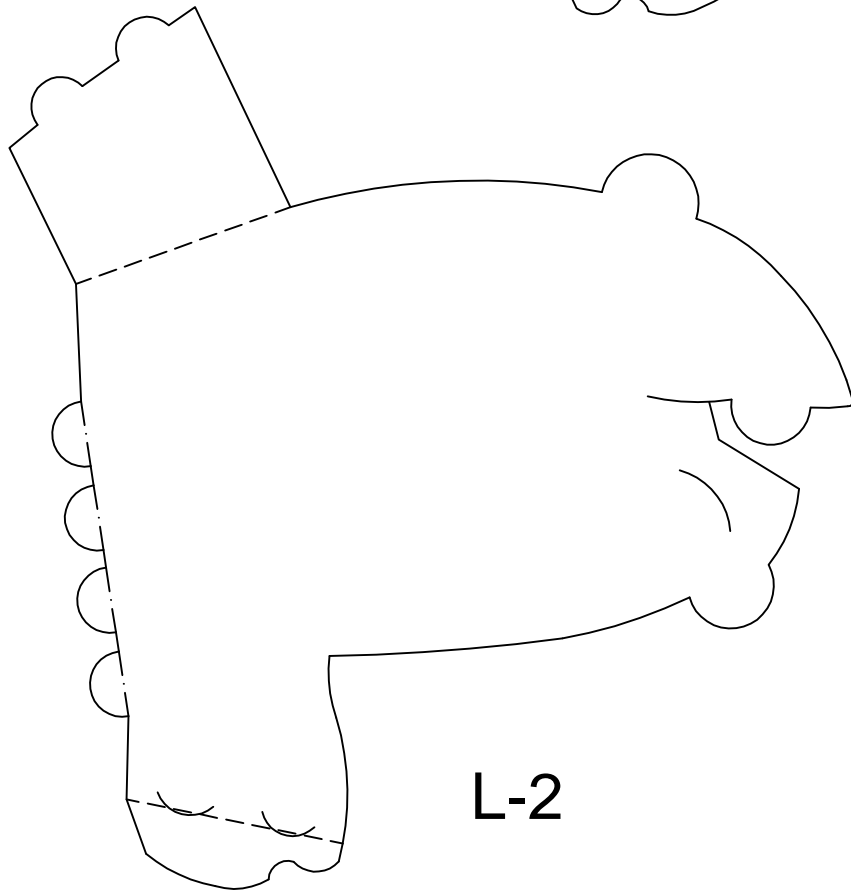
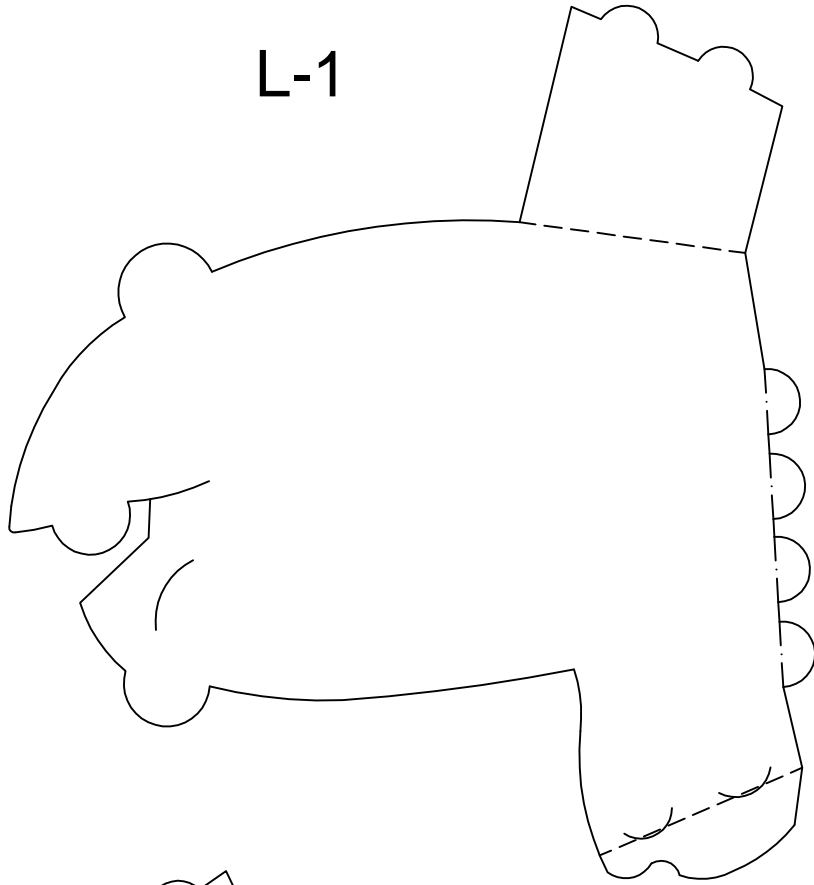

L-2

Cut _____
Valley-fold - - - - -
Mountain-fold - . - . - .

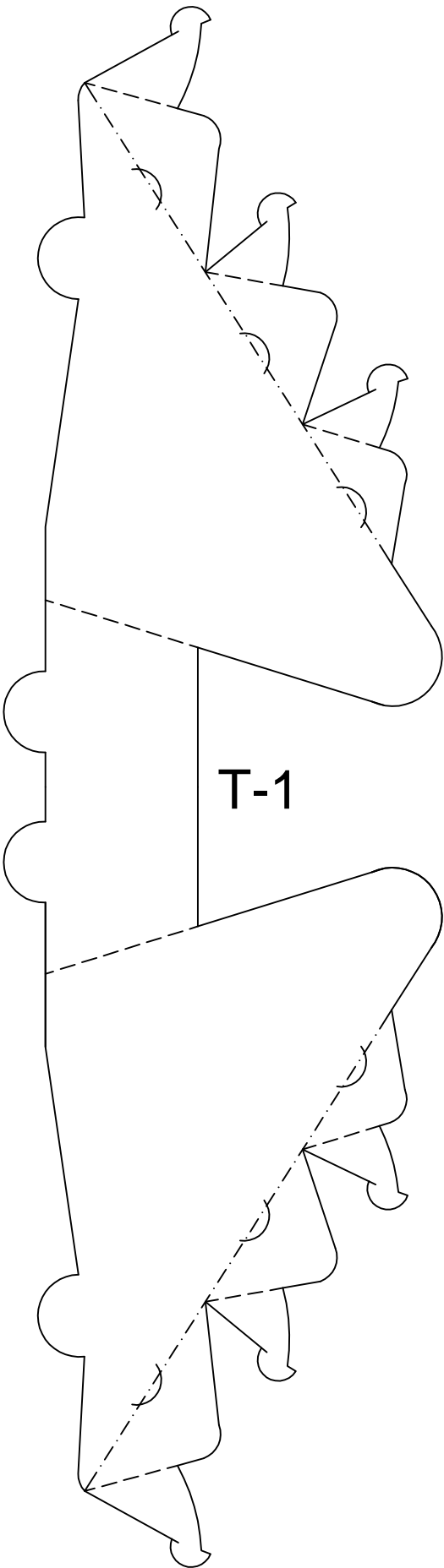

T-1

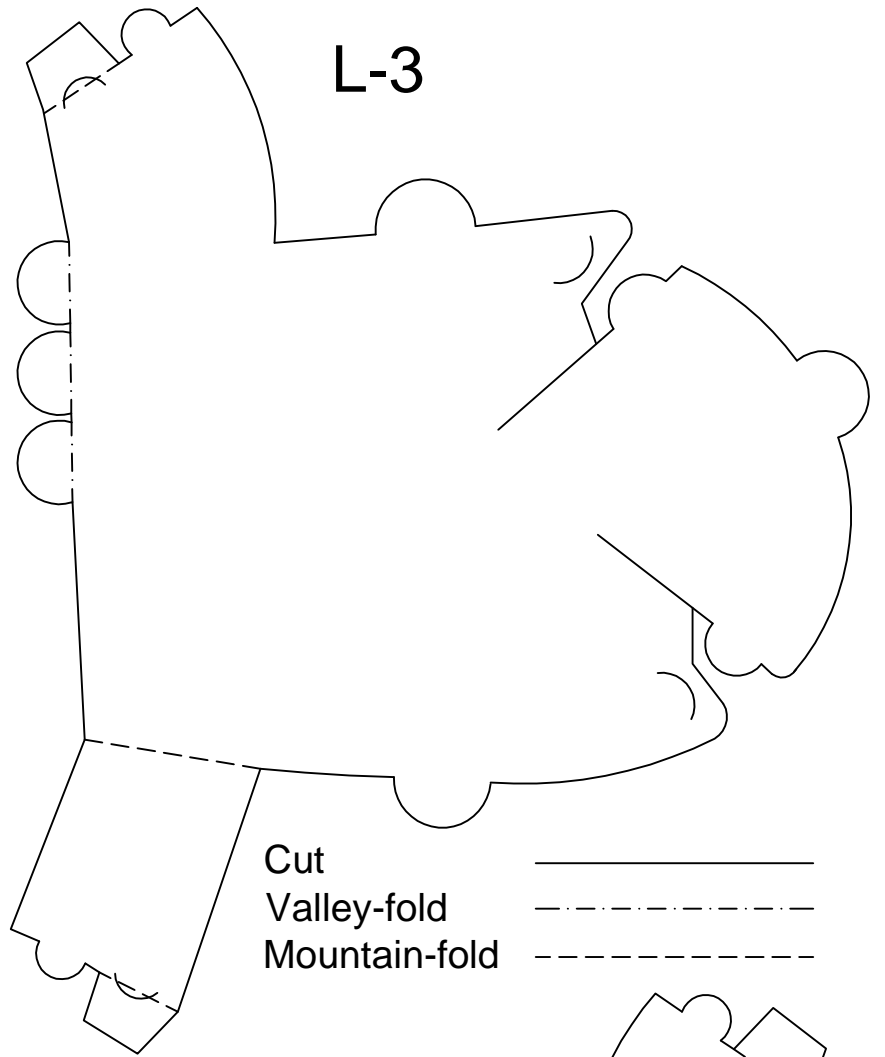

L-3

Cut _____
Valley-fold - - - - -
Mountain-fold - - - - -

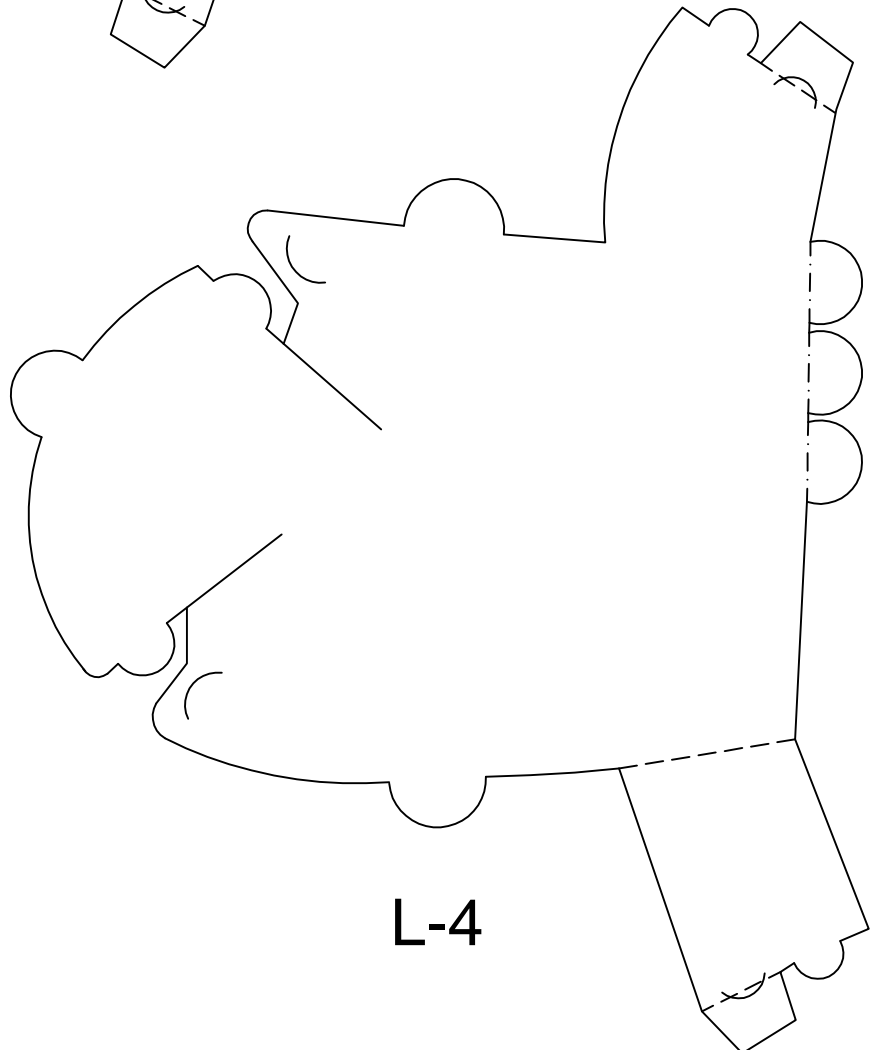

L-4