

Installation Instructions

**devireg[®] 700/750
751/752/753/754**

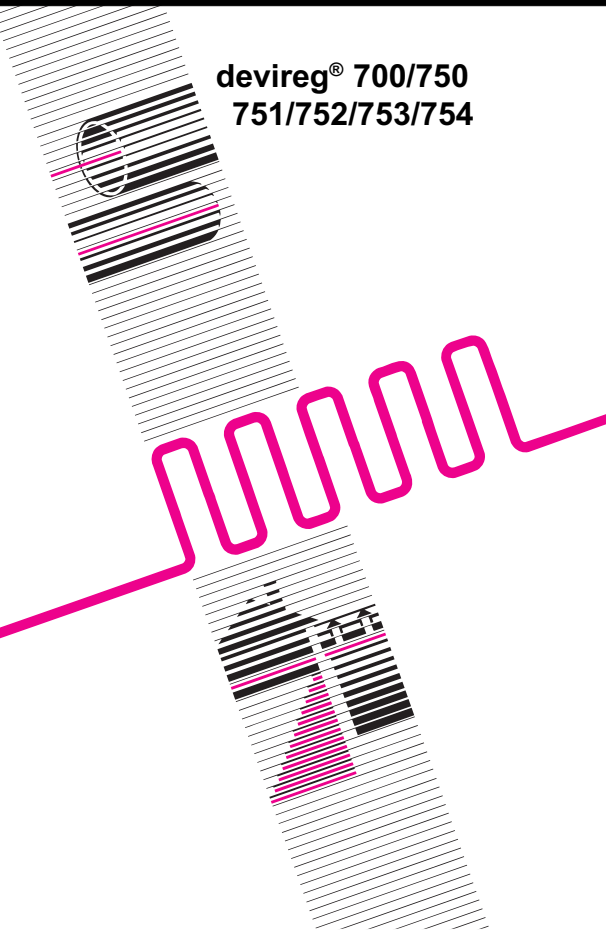

Application:

The devireg® 700 - 754 series is an universal control system used for regulation of storage heating systems.

The devireg® 700 - 754 series automatically adjusts itself to low tariff periods.

The devireg® 700 - 754 is a series of electronic controls designed to save energy and regulate floor heating during low tariff periods in connection with the outside temperature and the quantity of stored heat in the floor. As a result of this only the exact required amount of energy is used.

The devireg® 700- 754 series is designed to be mounted on DIN rails.

devireg® 700 - master unit:

devireg® 700 is a central control unit which via a sensor continuously measures the outdoor temperature and compen-sates for the wide variation of climatic conditions which are typical of spring and autumn. It uses the information it receives from the climatic conditions outside to make statistical calculations and regulate the other devireg® units in the 700 series with which it is connected.

As devireg® 700 is the central control unit, all other devireg® units in the 700 series are dependant on being connected with it.

The devireg® 700 can be connected with up to 100 sub stations, these sub stations could be devireg® 751/ 752/ 753/ 754 or combinations of them. This allows for a total capacity of controlling up to 400 individual rooms.

Installing devireg® 700:

devireg® 700 can be mounted on a DIN rail, in a fuse box cupboard or similar place.

The outdoor sensor has a length of 4 m and the indoor sensor has a length of 4 m. Both sensors can be extended up to 50 m.

Installing the outdoor sensor:

The outdoor sensor should be mounted at a minimum height of 2.5 m from the outside ground level. It is an advantage if it can be installed on the same side as the living room. If these are located in different positions of a building, a north or south facing wall should be used (Europe only).

The sensor should be installed flush on the surface of the outer wall.

Installing the indoor sensor:

The indoor sensor (which is provided with all units in the devireg® 700 series except the devireg® 700), should be positioned in the centre at the open end of a cable loop and on the same level as the cables. The sensor should be placed in an installation pipe which is sealed at the end to avoid concrete from entering during casting.

Connecting devireg®:

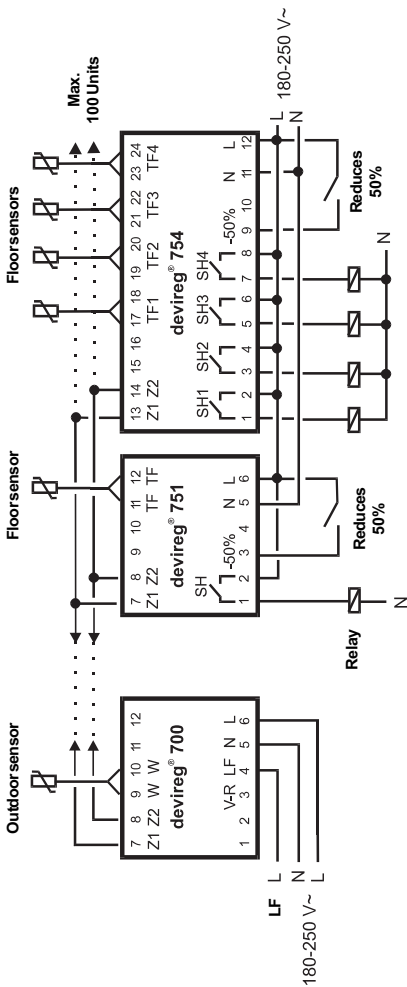

- LF:** The LF phase indicates the low tariff period. It is not important which wires are connected to which phase as long as there is a difference in voltage between terminal 4 and 5.
- V-R:** The phase on terminal 3 is used to change to continual regulation during a low tariff period. It is not important which wires are connected to which phase as long as there is a difference in voltage, between terminal 4 and 5. When there is no phase on terminal 3 delayed regulation will automatically be chosen.
- Z1-Z2:** These are communication outputs to sub units which can be coupled with devireg® 751, 752, 753 and 754. With devireg® 700, up to 100 units can be connected. The outward signal is a pulsating constant current of approx. 12 V where the pulse varies from 0 to 25 seconds depending on the temperature, the E1 setting, the low tariff period and the time of the day.

devireg® controls:



The consumption of energy during the night can be changed from +30% by turning the control button to the right and -30% by turning the control button to the left.



The consumption of energy during the day can be changed from +30% by turning the control button to the right and -30% by turning the control button to the left.



Maximum floor temperature: with this control button the floor temperature is set thus the storage heating in the floor is kept under the appropriate maximum temperature.

Setting the controls of E6

Installed effect	Surface	E6 setting
120 to 149 W/m ²	Ceramic	35°C
	Carpet	40°C
	Well insulated	45°C
150 to 170 W/m ²	Ceramic	40°C
	Carpet	45°C
	Well insulated	50°C
over 170 W/m ²	Ceramic	45°C
	Carpet	50°C
	Well insulated	55°C



Fully charged: this is the control which is set to the outside temperature to ensure a full charge.

First, the heating system is set to the designed temperature.

Example: E1 is set to -1°C. This means that with an outside temperature of -1°C and a tariff system of e.g. 8 + 2 hours, the indoor temperature will be maintained at 20°C.

RESET E1 is turned to the right.

The built-in 24 hour clock and all of the controls are set to zero. The next low tariff period will be registered as a night period. The reset function is delayed by approx. 2 seconds. When the system is in RESET, the control light (()) flashes on and off.



The control light is on when the built-in clock registers the night period.



The control light lights green when the heat in the floor is less than the E6 setting and the output relay is not activated.



The control light lights red when the warmth in the floor is less than the E6 setting and the output relay is activated.



The control light is turned off when the heat in the floor is equal to the E6 setting.

Alarm function:

Floor sensor

When short circuited or disconnected,  flashes rapidly and the relay is cut off.

Outdoor sensor

When short circuited or disconnected,  flashes rapidly and the relay is cut off.

Comm.

When the communication wire short-circuits,  flashes rapidly and the relay is cut off.

Low tariff guard.

If the LF signal lasts more than 16 hours without pause or if the low tariff period differs with more than two hours from the previous day, the relay will be cut off and  will blink rapidly.

Function:

Continual regulation

When continual regulation has been chosen (see V-R phase) the floor temperature will be regulated during the entire low tariff period. The heat will be turned on at the same time as the low tariff period starts. Depending on the outside temperature and the floors storage heat, the heat will be turned off.

Continual regulation is used when low tariff periods vary in time and length from day to day or when the night and day time tariffs are identical.

The reset function is used to synchronise the 24 hour built-in clock. After resetting, the night period will start, lasting 11 hours. After this the day period starts which also lasts 11 hours. The remaining 2 hours are used to wait for the low tariff period which will synchronise the built-in clock.

V-R = Continual control:

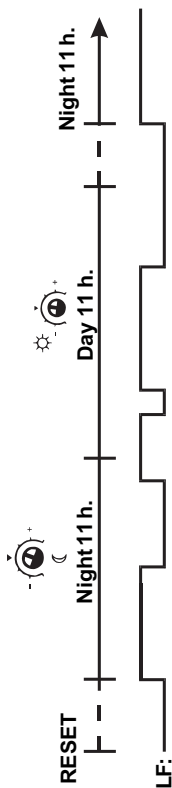

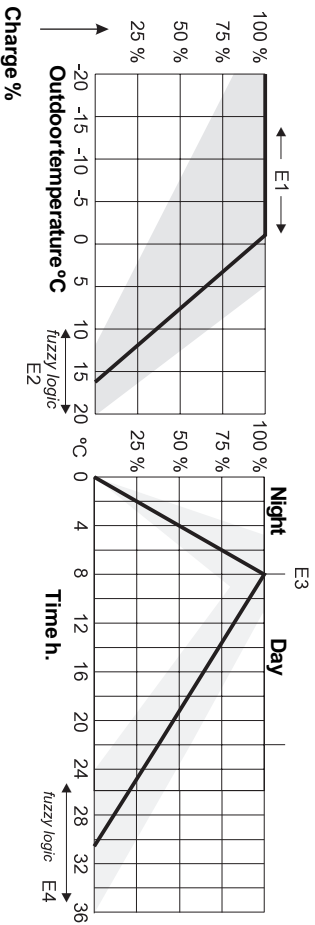

Delayed regulation:

When the set-back has been chosen (see V-R phase) the time at which the heating would otherwise be turned on is delayed so that it is turned off at the same time as the low tariff period ends. The charging up of the floor and the discharging are time controlled in ramp form.



Trouble-shooting:

1. Check the mains voltage (fuses and fault current RCD relay).
2. Connect the LF- signal by short-circuiting clamp 4 and 6.
3. Day and night are set to middle.
4. E1 is set to RESET. Then the inbuilt clock is set to 0 and the calculated energy consumption is set to 50%.
5. E6 is set to maximum (60°C). If the floor temperature is less than 40°C  must flash red and the output relay should be activated. If the relay will not activate, adjust NIGHT to maximum. Ensure that there is voltage to the heating cables.
6. E6 is set to a minimum (20°C).
If the floor temperature is above 20°C  flashes red and the output relay must be deactivated. If the relay does not deactivate adjust NIGHT to a minimum. Ensure that there is no voltage to the heating cables.
7. The floor temperature can be controlled by setting NIGHT and DAY to their middle positions and turning E1 away from the RESET position. Locate the point at which  changes from off to a green light by adjusting E6. The floor temperature can be seen on the E6 scale.
8. Checking the Comm. output.
Measure the voltage between clamps 7 and 8 with a normal voltmeter. The voltage should change between 0 V and approx. 12 V. When E1 is set to RESET there should be approx. 12 V for 8 seconds and 0 V for 18 seconds.
9. The sensor can be checked with an Ohmmeter in accordance with the diagram on next page. When short-circuited or disconnected the alarm will go off.

NTC Sensor

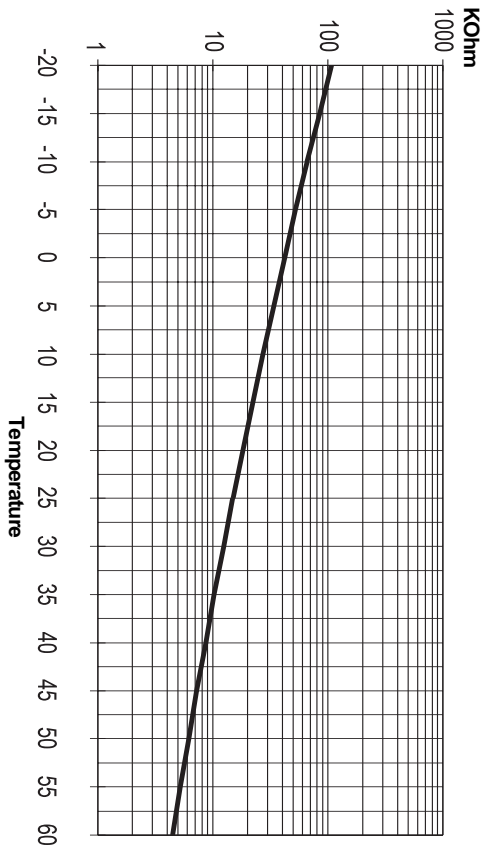

Technical data for devireg® 751/750

Voltage:	180 - 250 V ~ 50 - 60 Hz
Load:	250 V ~ 10 A.
Load:	Cos φ = 0.3 max. 1 A
Moistureproof:	IP 20
Sensor type:	NTC 15kOhm at 25°C
Operation temperature:	-10°C to +45°C
Mounting:	DIN rail 35 mm. DIN - EN 50022
Comm. Z1-Z2:	0 - approx. 12 V DC. pulsating, max 100 units

devireg® 700:

The same technical specifications as a devireg® 750 but without the output relay.

devireg® 752:

The same technical specifications as a devireg® 751 but with an adapter for 2 floor sensors with a load capacity of 8 A per output.

devireg® 753:

The same technical specifications as a devireg® 752 but with an adapter for 3 floor sensors with a load capacity of 8 A per output but with a max. combined load of 16 A for all three outputs.

devireg® 754:

The same technical specifications as a devireg® 753 but with an adapter for 4 floor sensors with a load capacity of 8 A per output but with a max. combined load of 16 A for all four outputs.

devireg® 750:

devireg® 750 is designed to control a single room. devireg® 750 is a combination of devireg® 700 and a devireg® 751. It can be connected with a floor sensor and an outdoor sensor.

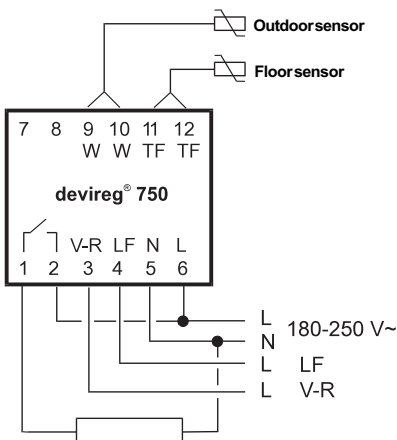

The DEVI Warranty:

You have purchased a deviheat® system, which we are certain will increase your home comfort and economy.

deviheat® provides complete heating solutions with deviflex® heating cables or devimat® heating mats, devireg® thermostats and devifast fitting bands.

If, however, contrary to all expectations, a problem should occur with your heating system, we at DEVI, with manufacturing units in Denmark, are, as European Union suppliers, subject to general product liability rules, as stated in Directive 85/374/CEE, and all relevant national laws which implies that: DEVI provides a warranty for deviflex® heating cables and devimat® heating mats for a 10 year period and all other DEVI products for a 2 year period against defects in material and production.

The guarantee is granted on the conditions that the WARRANTY CERTIFICATE on the overleaf is filled out properly in accordance to instructions and that the defect is inspected by, or presented to, DEVI or authorised DEVI distributor.

Please note, that the wording of the WARRANTY CERTIFICATE must be provided in english or local language with the ISO code for your country in the upper left corner of the

front page of the installation instruction in order to release the warranty.

The obligation of DEVI will be to repair or supply a new unit, free of charge to the customer, without secondary charges linked to repairing the unit. In case of defective devireg® thermostats, DEVI reserves the right to repair the unit free of charge and without unreasonable delay to the customer.

The DEVI warranty only covers connections made by authorised electricians and installations performed in accordance with the installation instruction, and does not cover faults caused by incorrect designs supplied by others, misuse, damage caused by others, or incorrect installation or any subsequent damage, that may occur. If DEVI is required to inspect or repair any defects caused by any of the above, then all work will be fully chargeable.

The DEVI warranty is void, if payment of the equipment is in default.

At all times, we at DEVI will respond honestly, efficiently and promptly to all queries and reasonable requests from our customers.

The above mentioned warranty concerns product liability whereas matters in relation to legislation on sale of goods shall be referred to national law.

Warranty Certificate

The DEVI Warranty is granted to:

Name:

Address:

Postal code:

Phone:

Please Observe!

In order to obtain the DEVI Warranty, the following must be carefully filled in. See other conditions on the overleaf.

Electrical Installation by:

Installation date:

Type of thermostat:

Production code:

Suppliers Stamp:



DE-VI
DK · 7100 Vejle
Tlf. +45 76 42 47 00
Fax +45 76 42 47 03

08090022 · 02.01