

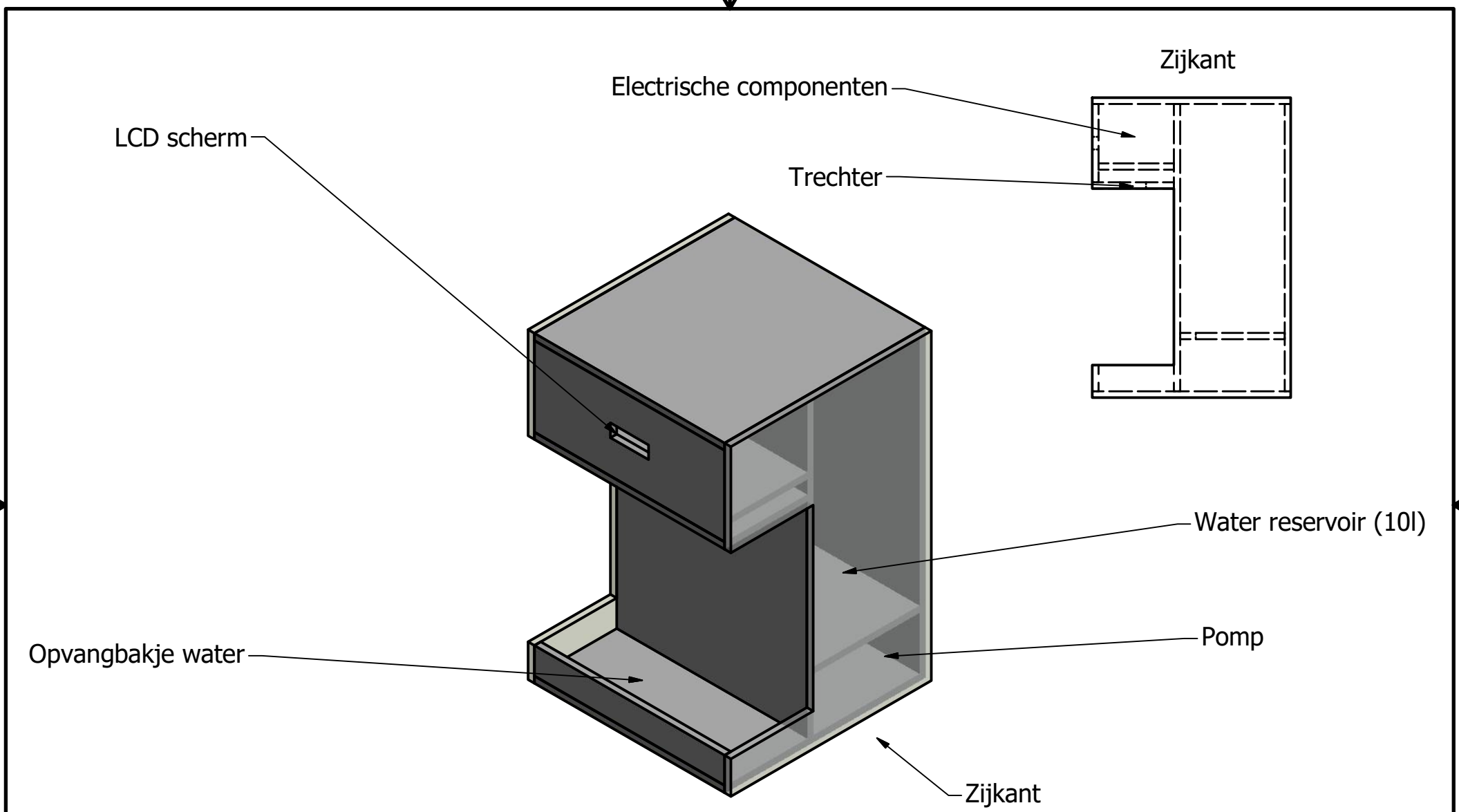



Designed by Margot De haene	Checked by	Approved by	Date	Date 31/05/2020	
			Sens'O		
				Edition 1	Sheet 1 / 12



Designed by Margot De haene	Checked by	Approved by	Date	Date 31/05/2020	
			<b>Sens'O</b>		

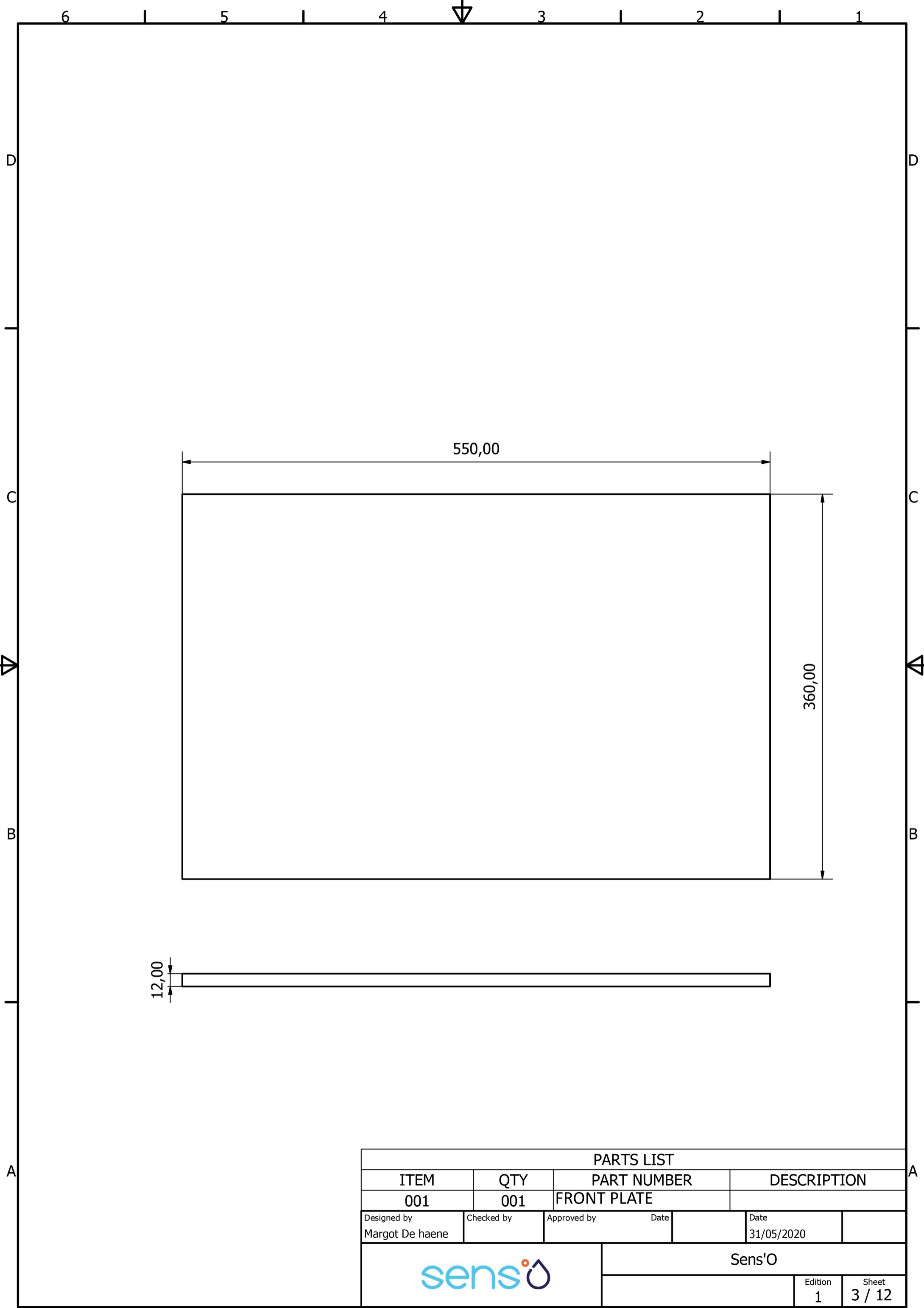

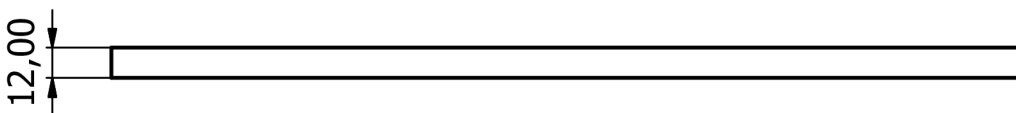
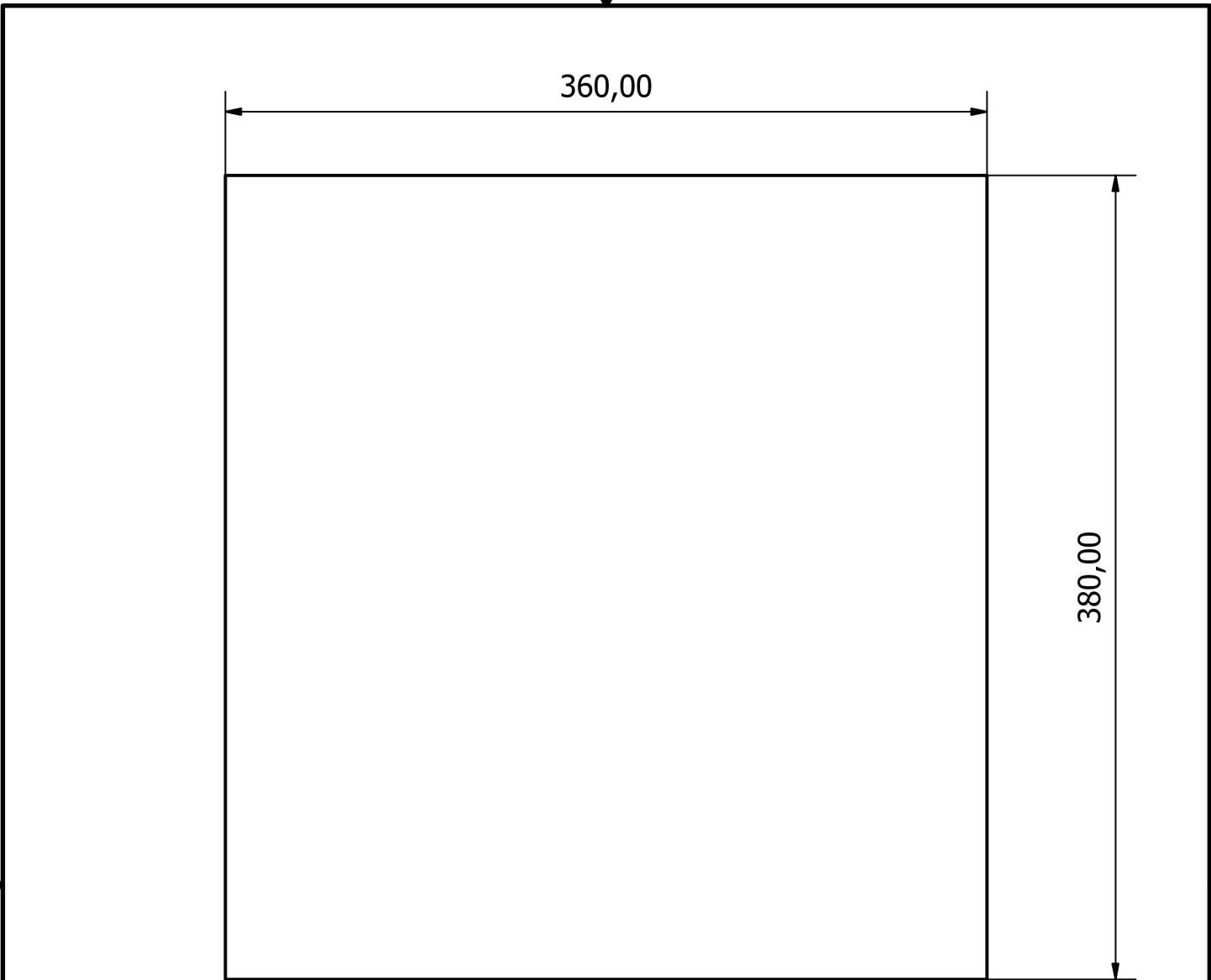

PARTS LIST			
ITEM	QTY	PART NUMBER	DESCRIPTION
001	001	FRONT PLATE	
Designed by Margot De haene	Checked by	Approved by	Date 31/05/2020
		Sens'O	
		Edition 1	Sheet 3 / 12



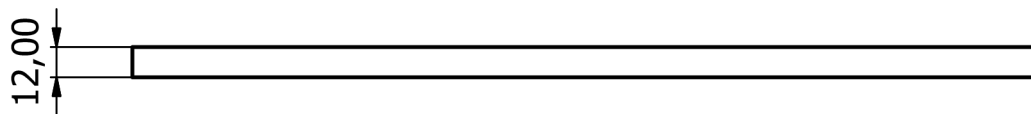
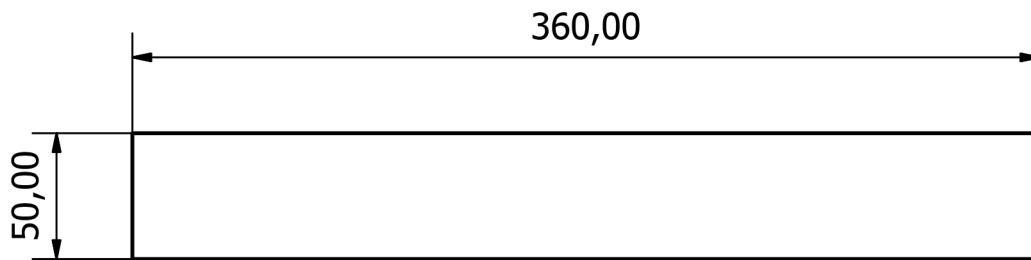

PARTS LIST			
ITEM	QTY	PART NUMBER	DESCRIPTION
002	001	TOP PLATE	
Designed by Margot De haene	Checked by	Approved by	Date
			31/05/2020
		Sens'O	
		Edition 1	Sheet 4 / 12





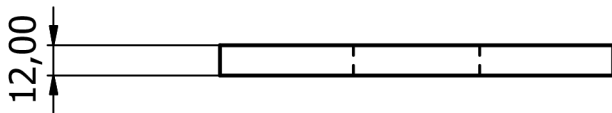
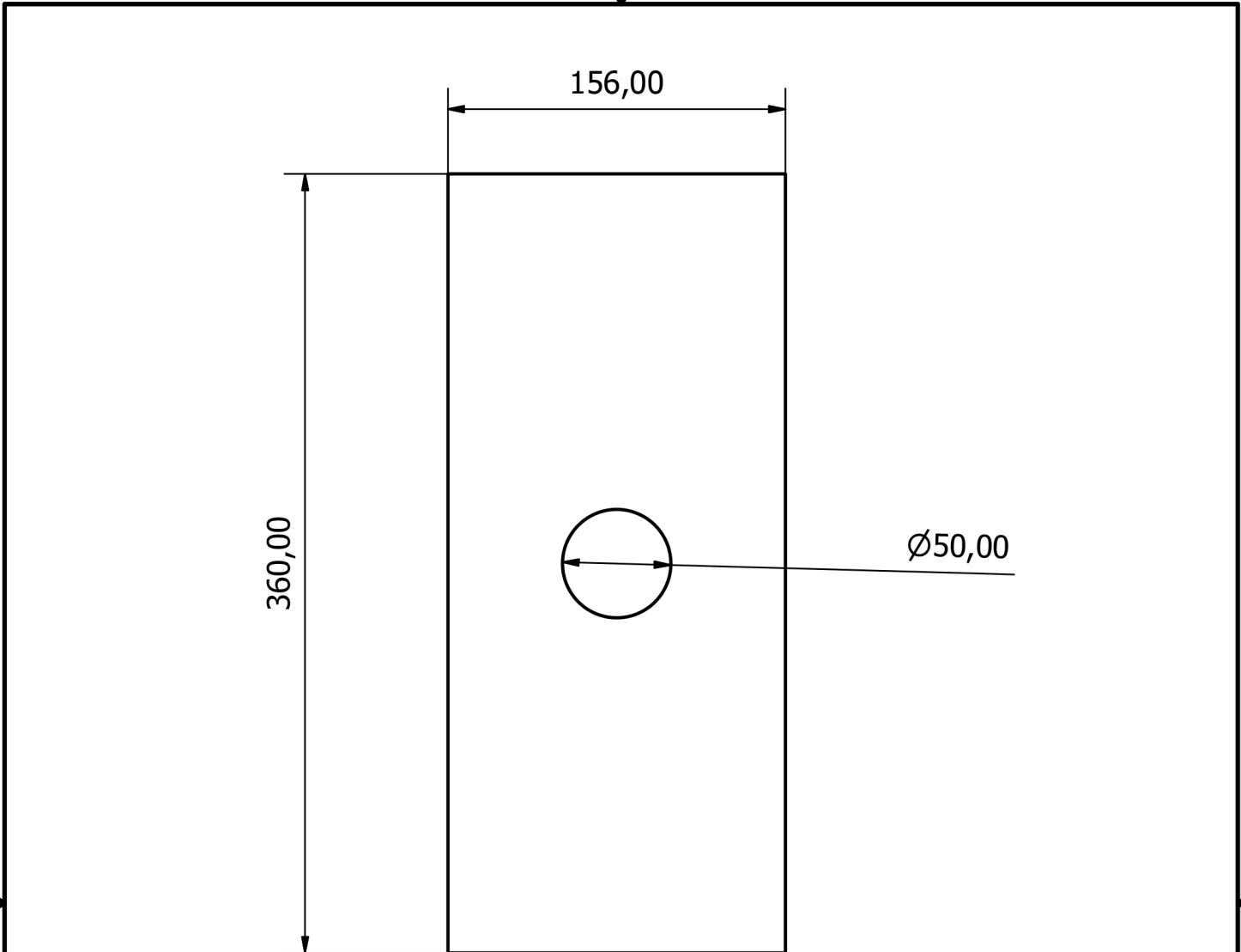

PARTS LIST			
ITEM	QTY	PART NUMBER	DESCRIPTION
003	001	SMALL FRONT PLATE	
Designed by Margot De haene	Checked by	Approved by	Date 31/05/2020
		Sens'O	
			Edition 1



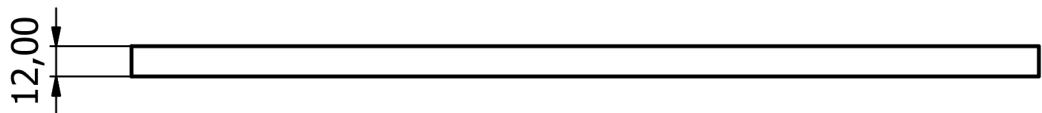
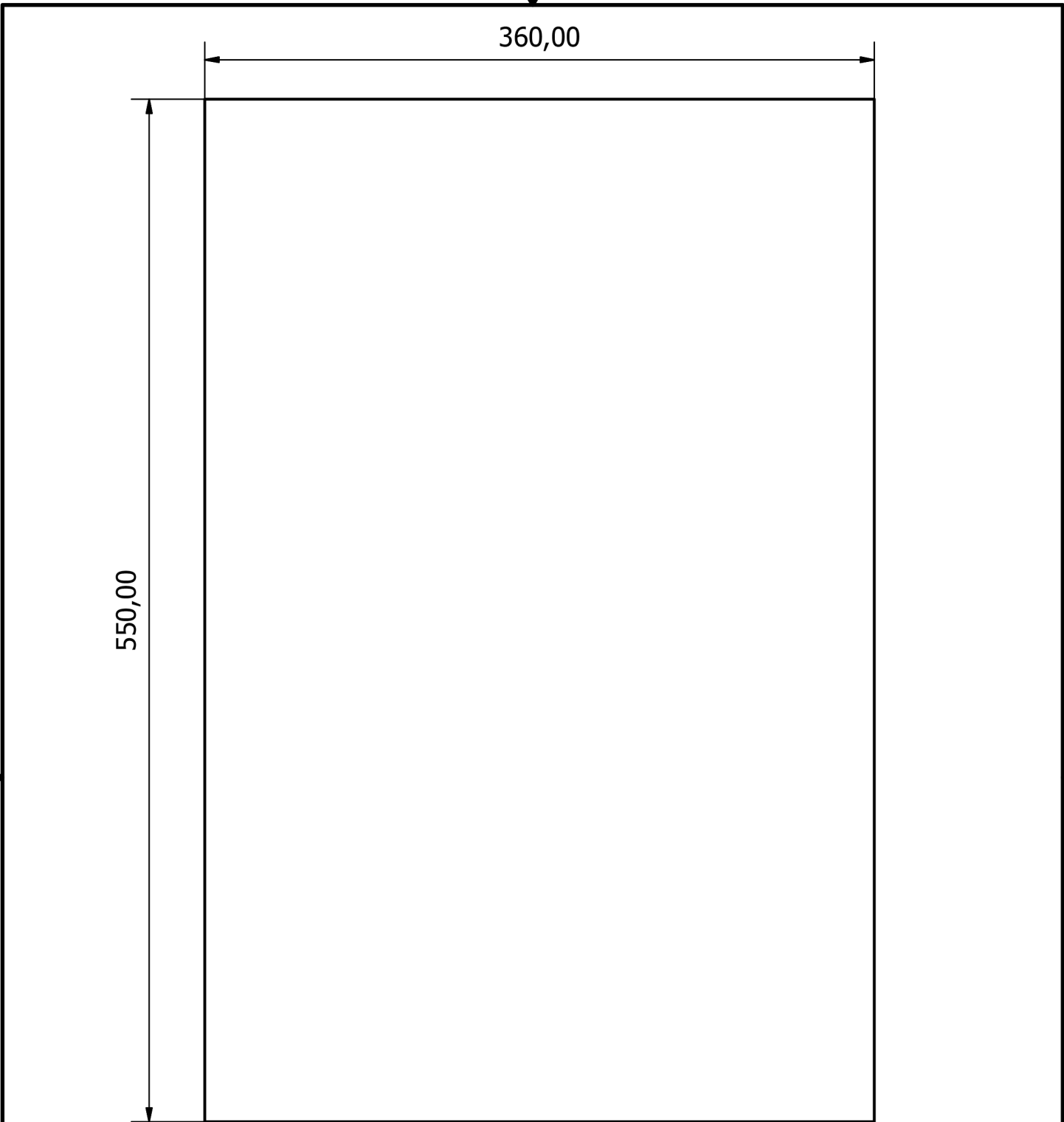

PARTS LIST			
ITEM	QTY	PART NUMBER	DESCRIPTION
004	001	BOTTOM PLATE FUNNEL	
Designed by Margot De haene	Checked by	Approved by	Date 31/05/2020
		Sens'O	
			Edition 1





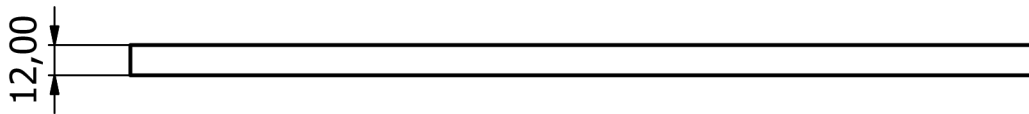
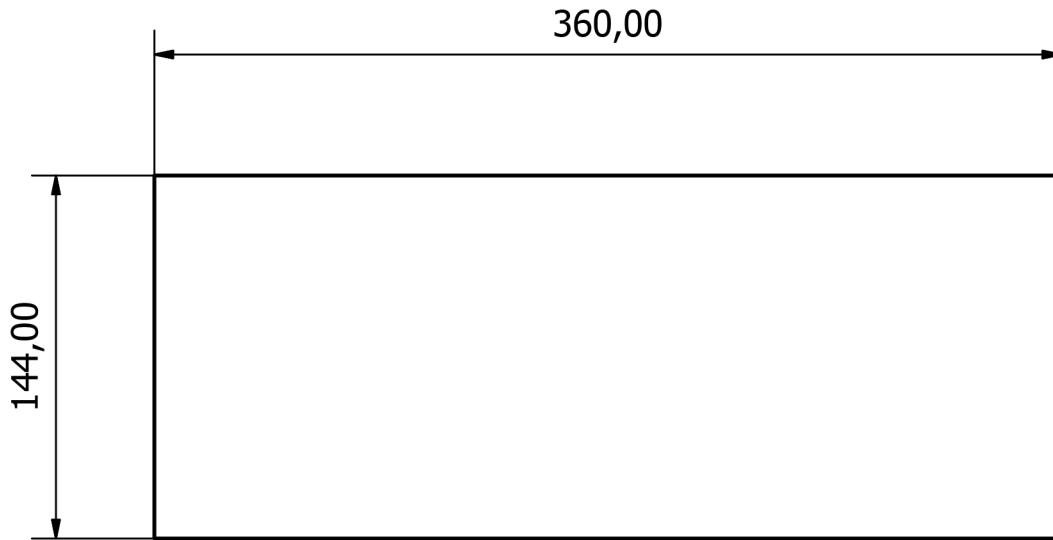

PARTS LIST			
ITEM	QTY	PART NUMBER	DESCRIPTION
005	001	BACK PLATE	
Designed by Margot De haene	Checked by	Approved by	Date
			31/05/2020
		Sens'O	
			Edition 1

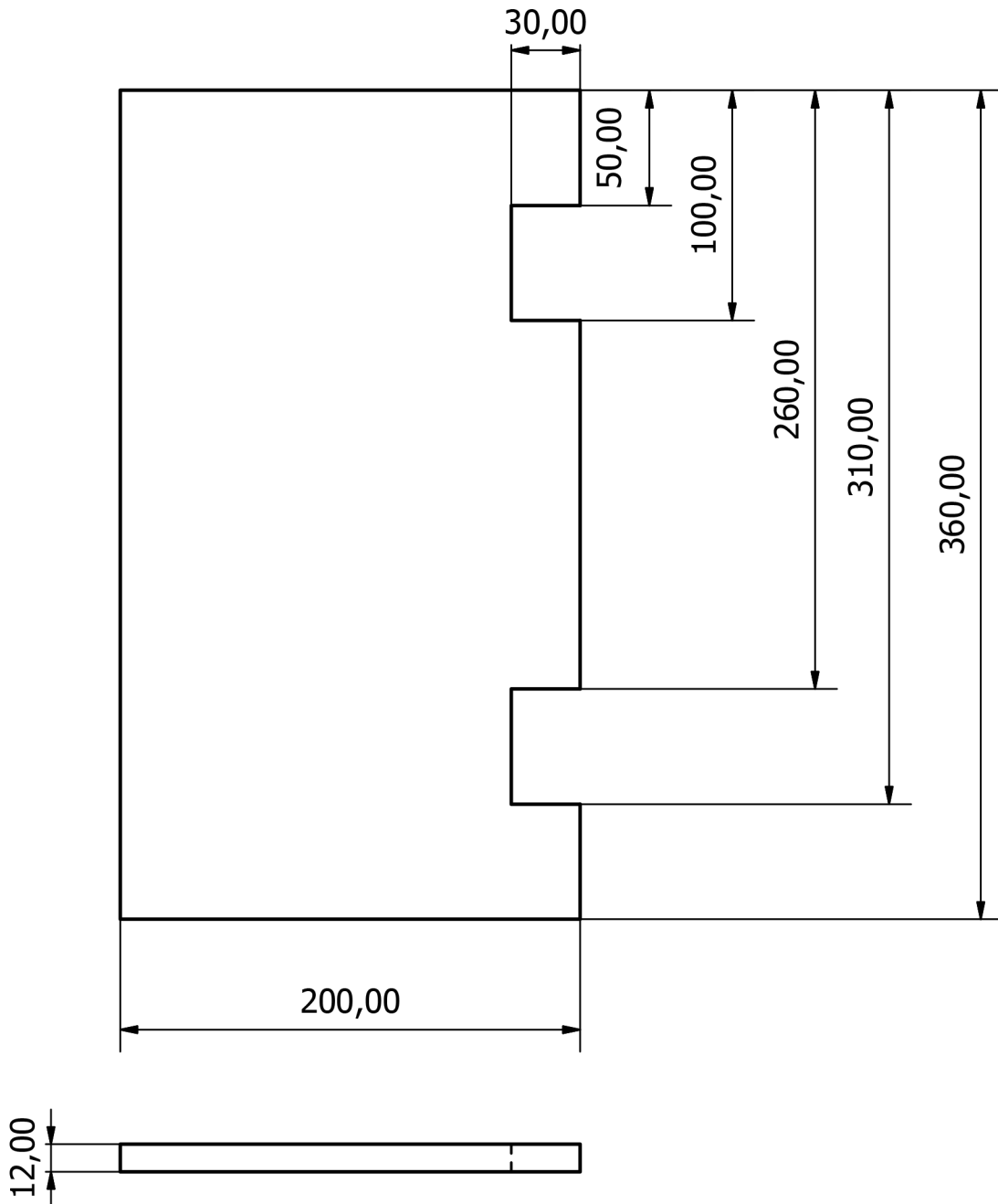

PARTS LIST			
ITEM	QTY	PART NUMBER	DESCRIPTION
006	001	PARTITION	
Designed by Margot De haene	Checked by	Approved by	Date 31/05/2020
		Sens'O	
			Edition 1



PARTS LIST			
ITEM	QTY	PART NUMBER	DESCRIPTION
007	001	PARTITION 2	INSIDE WITH CABLE SPOTS
Designed by Margot De haene	Checked by	Approved by	Date 31/05/2020
		Sens'O	
		Edition 1	Sheet 9 / 12

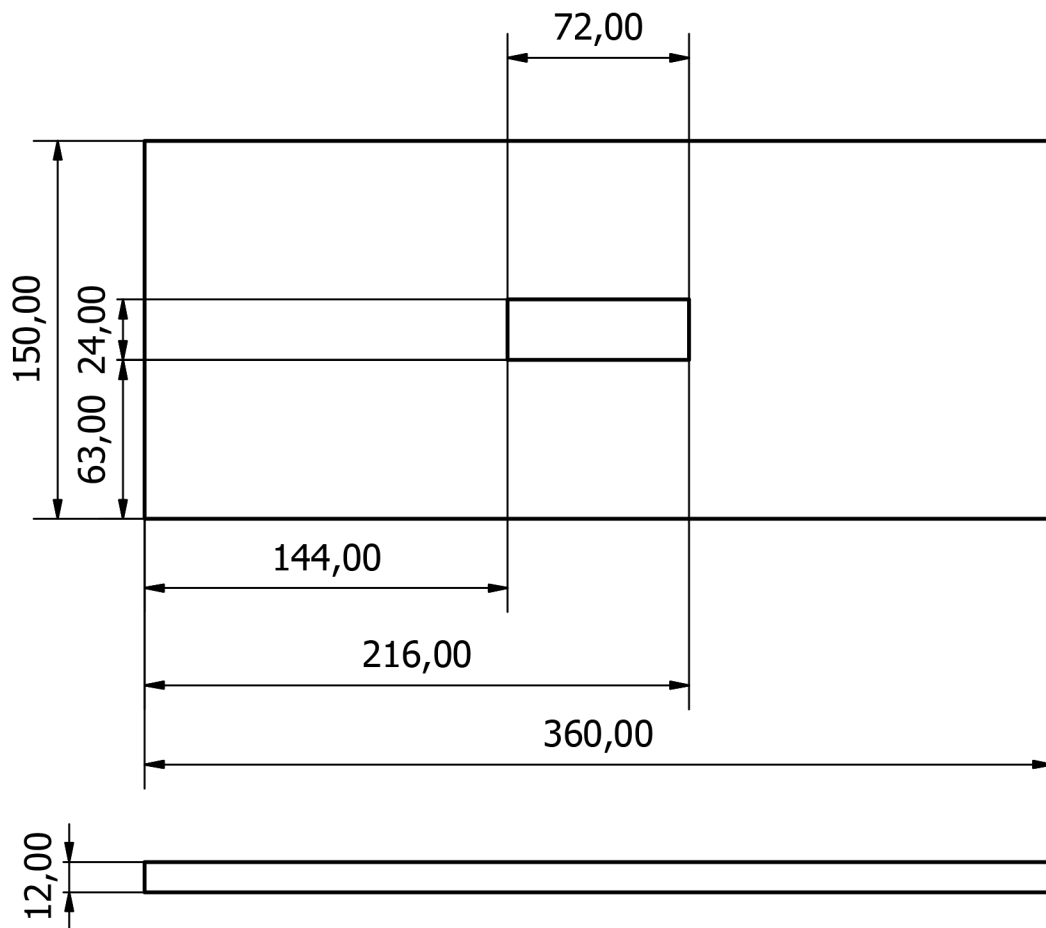

PARTS LIST			
ITEM	QTY	PART NUMBER	DESCRIPTION
008	001	FRONT PLATE WITH LCD	
Designed by Margot De haene	Checked by	Approved by	Date 31/05/2020
		Sens'O	
			Edition 1

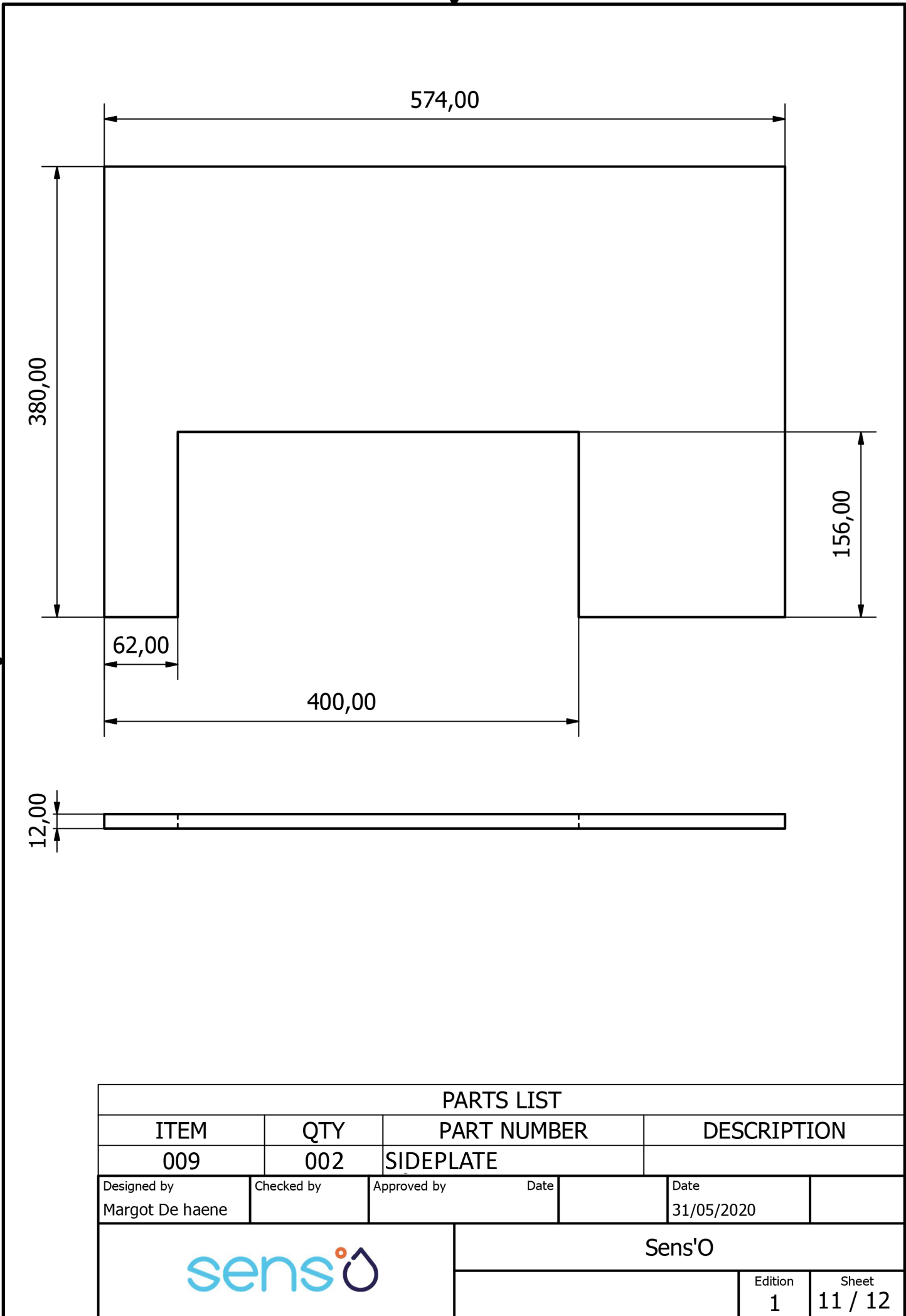

PARTS LIST			
ITEM	QTY	PART NUMBER	DESCRIPTION
009	002	SIDEPLATE	
Designed by Margot De haene	Checked by	Approved by	Date
			31/05/2020
		Sens'O	
		Edition 1	Sheet 11 / 12

