

Alternate designs from  
the Art of Star Wars

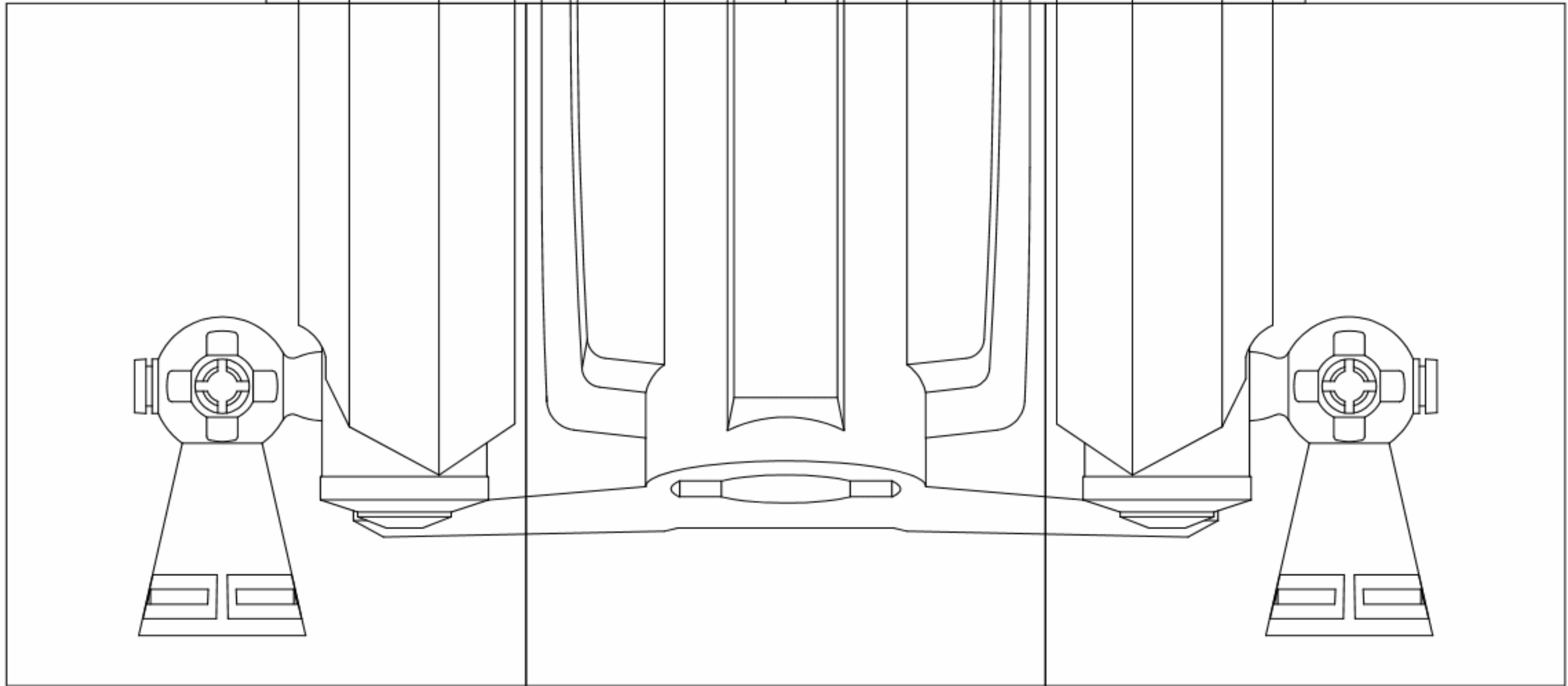

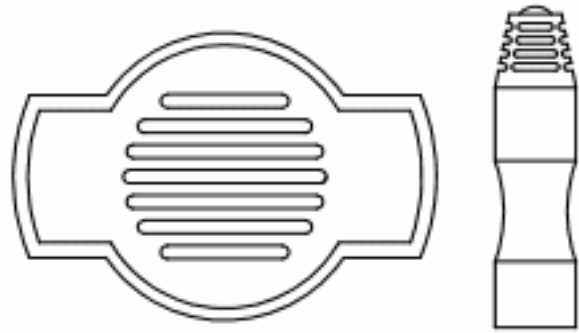

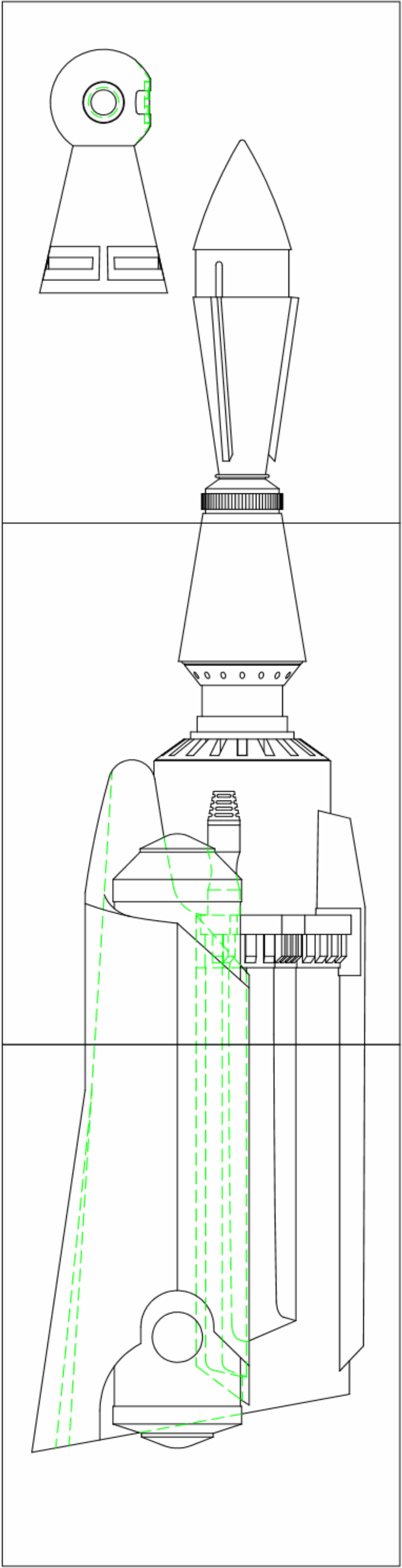

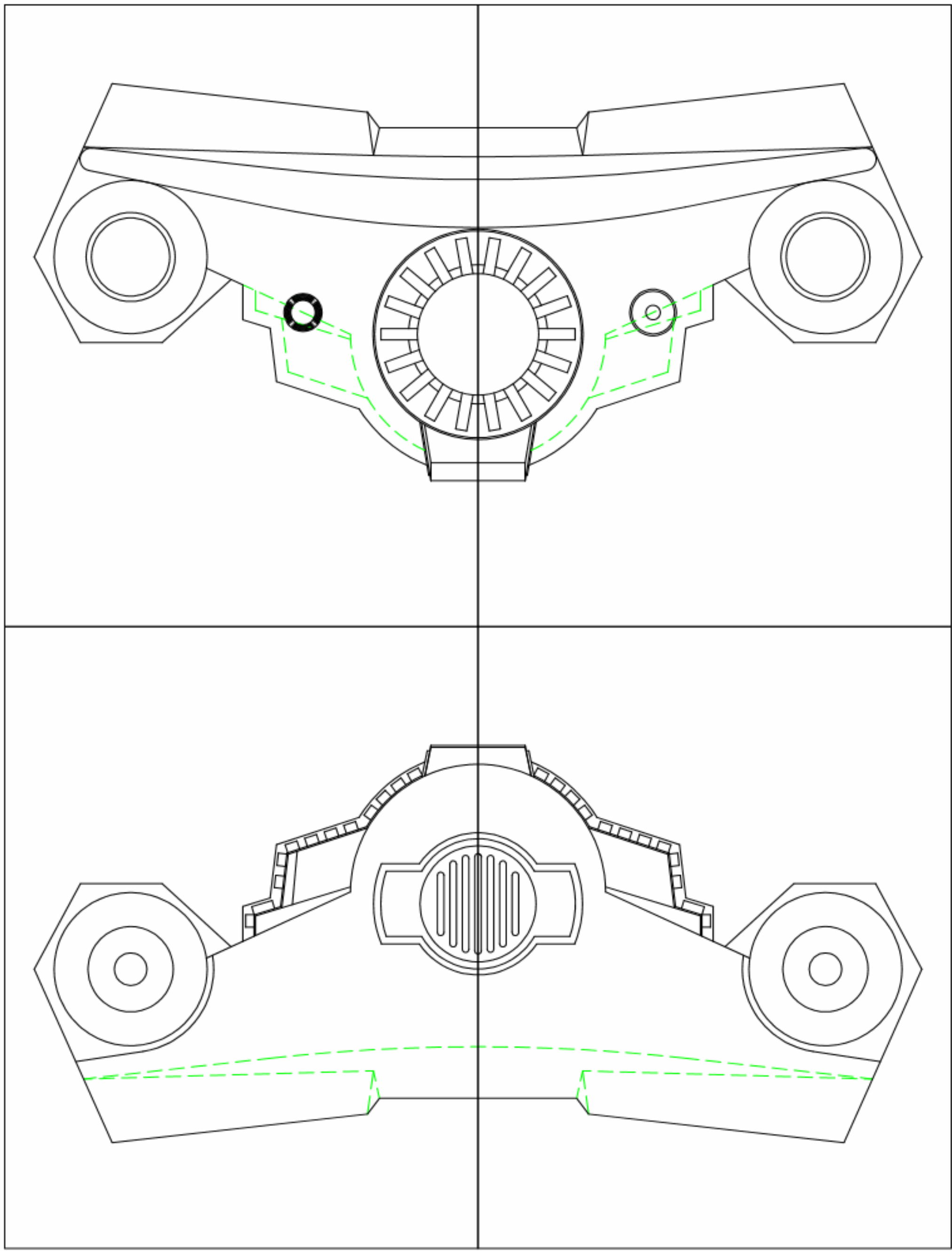
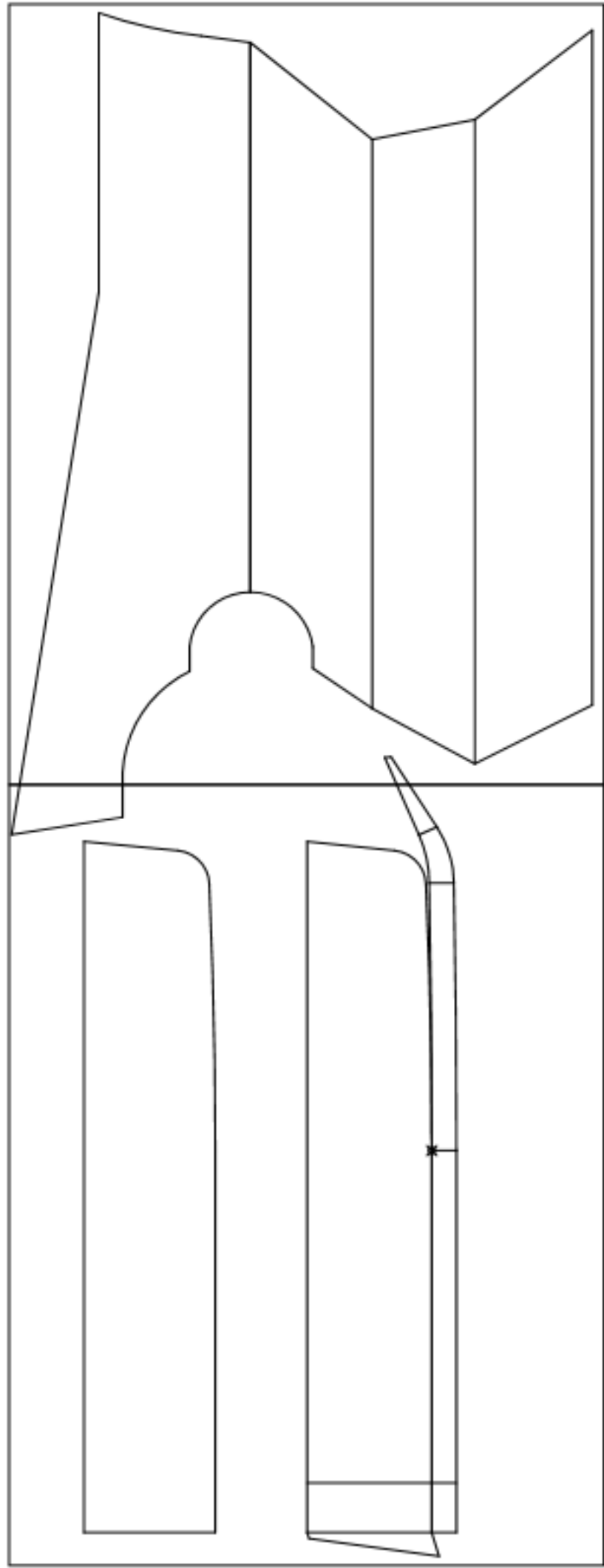
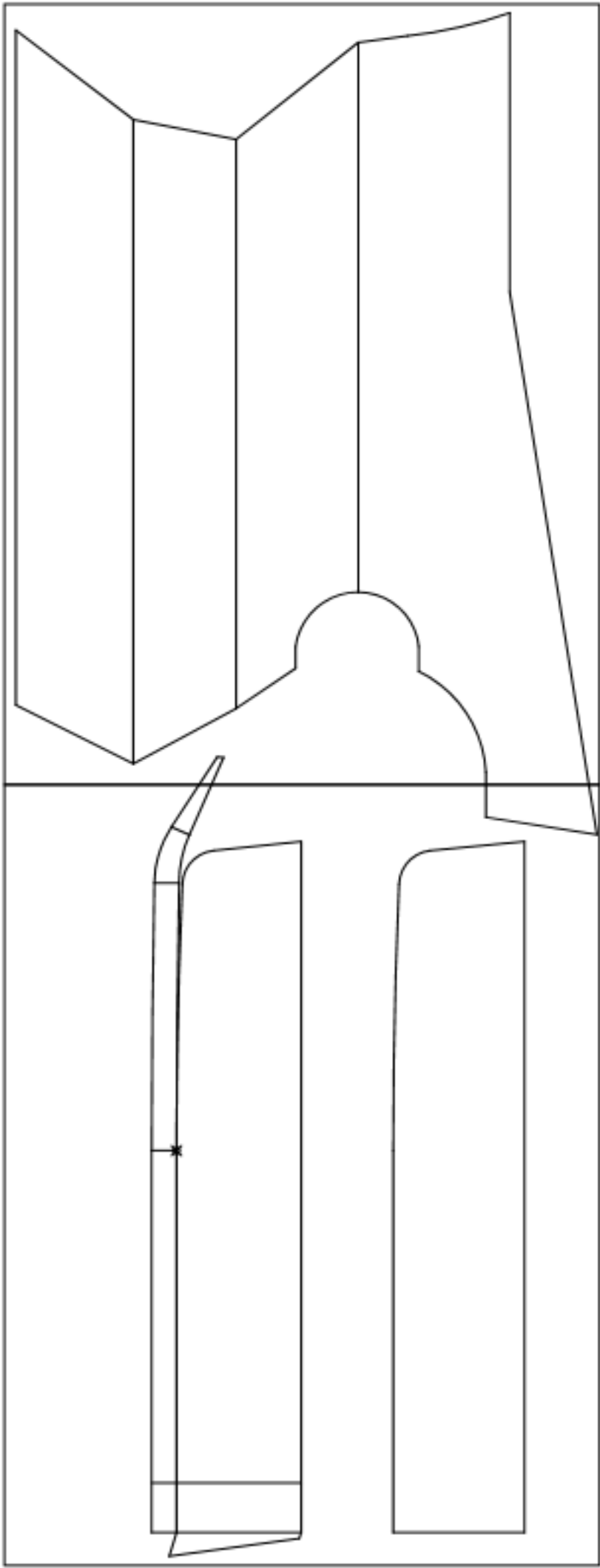
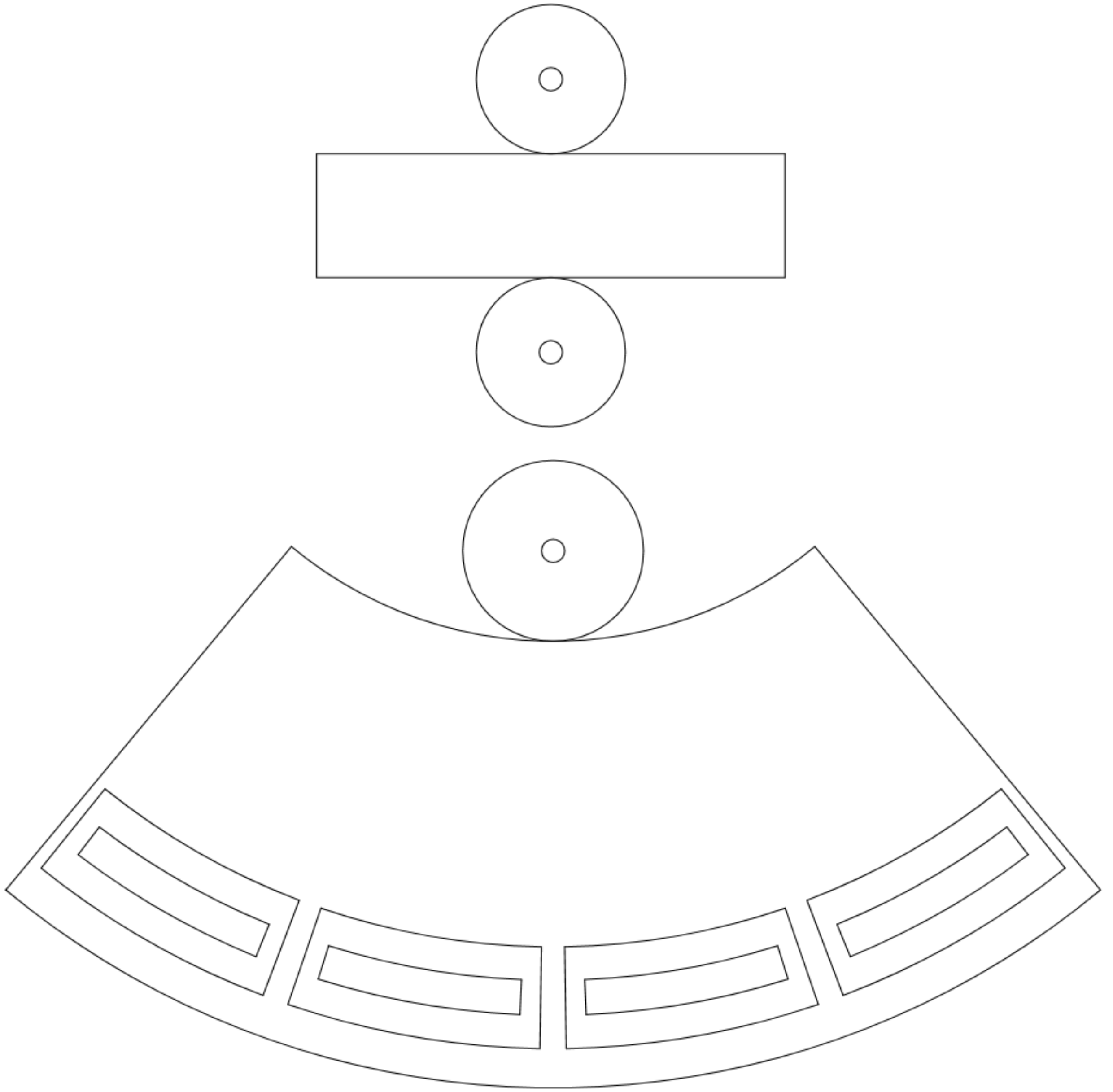

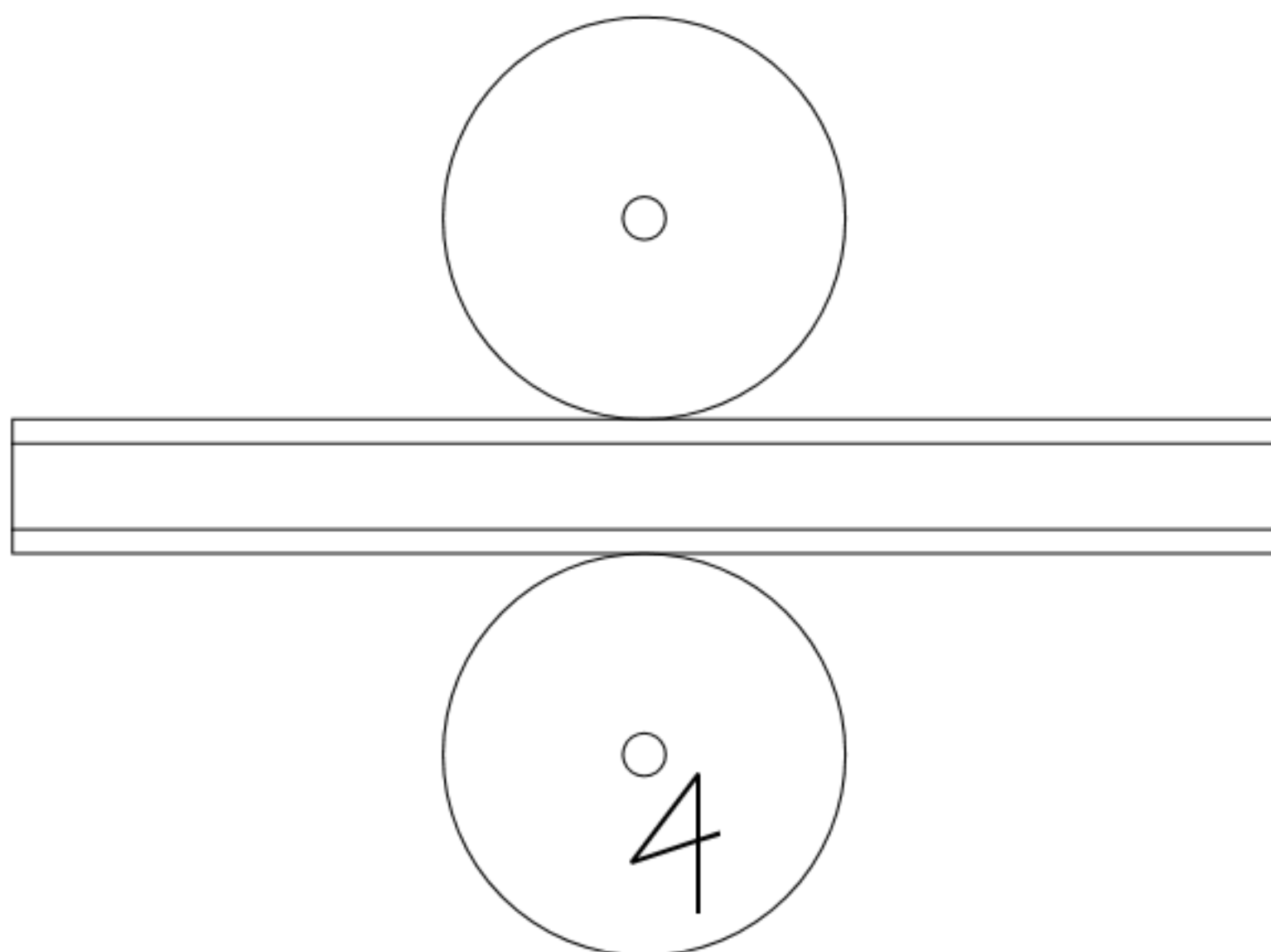
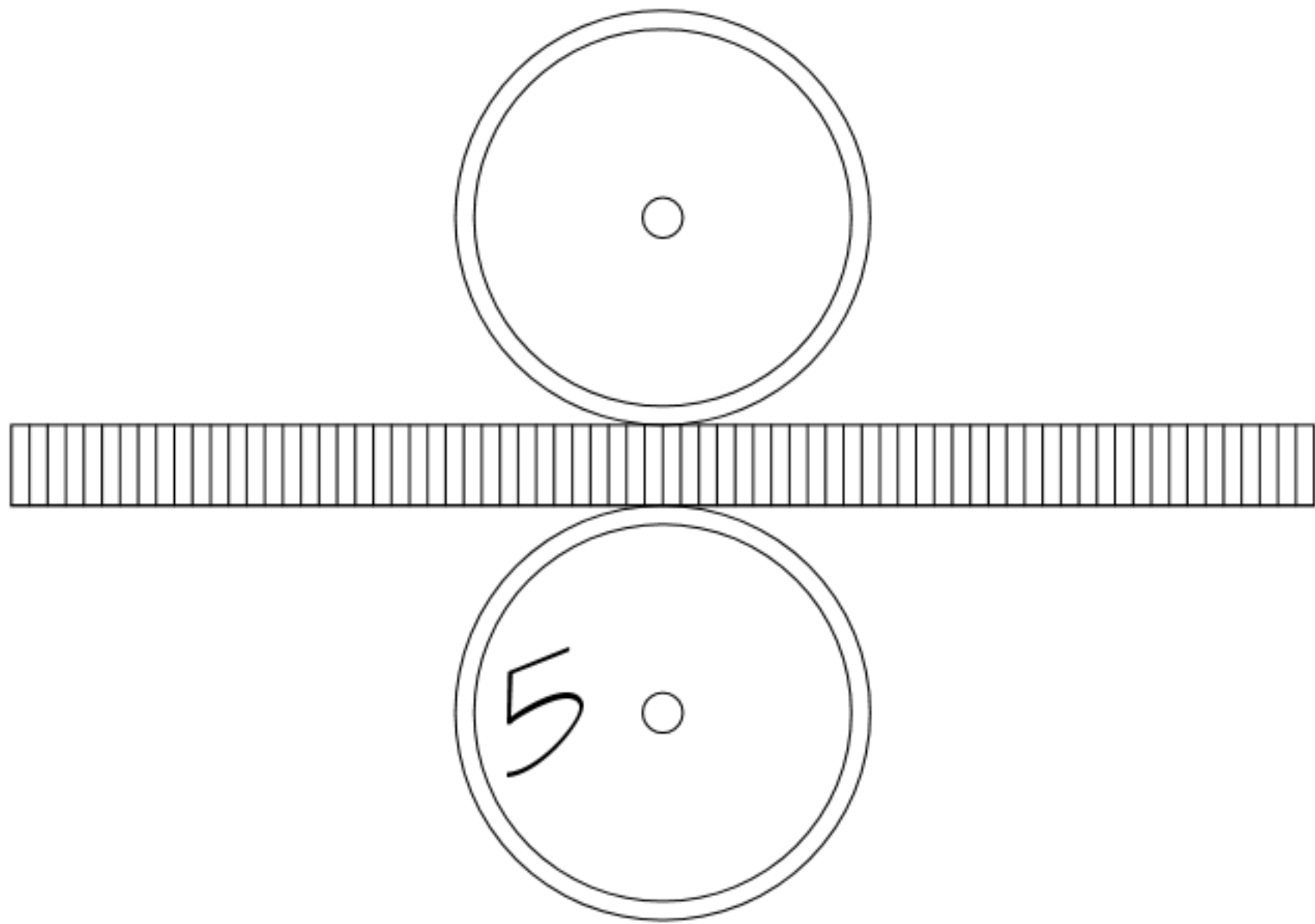



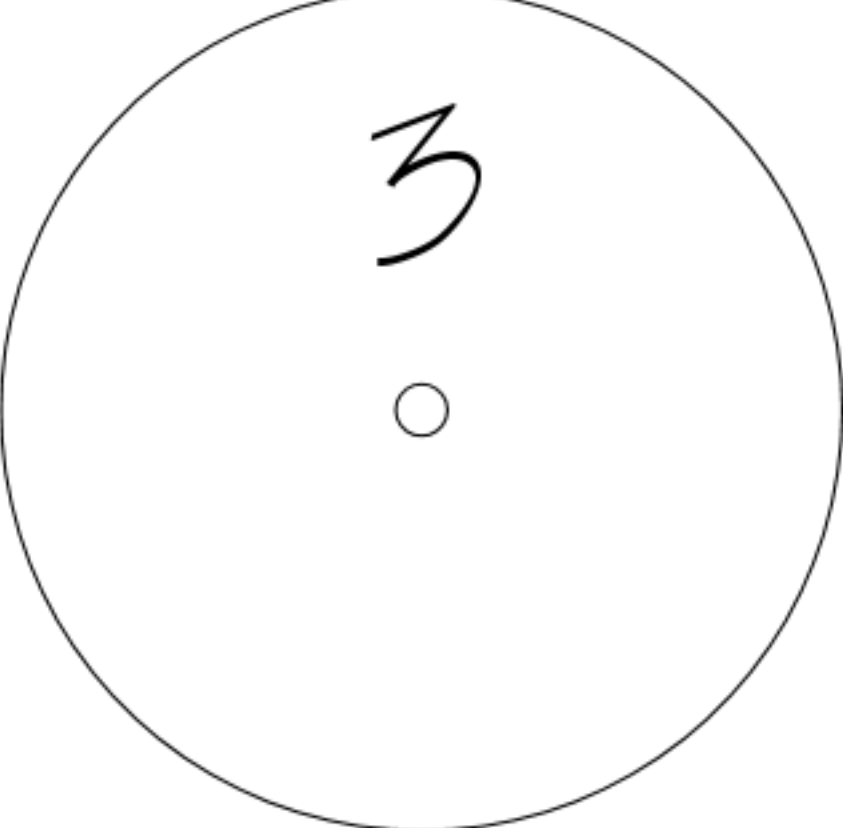
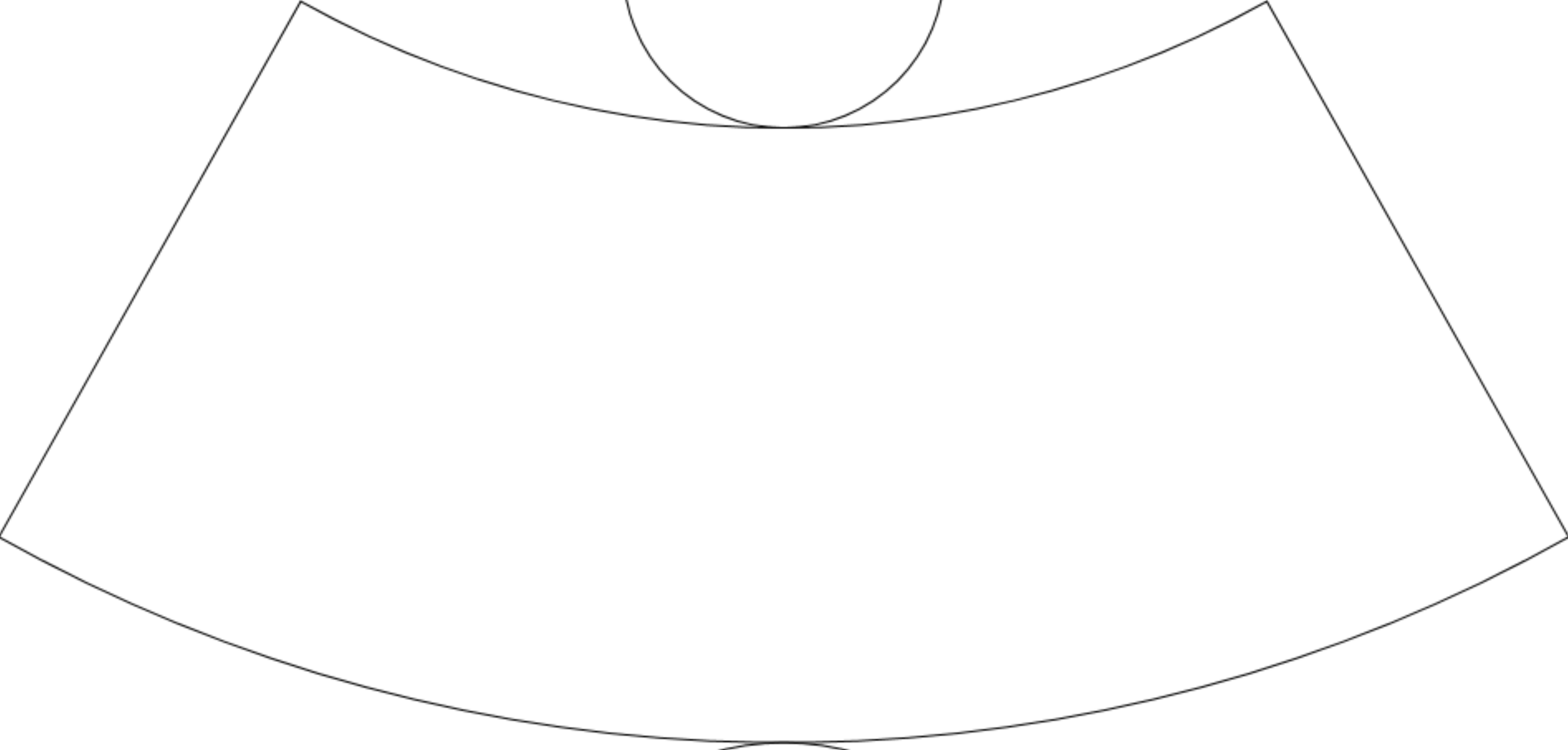
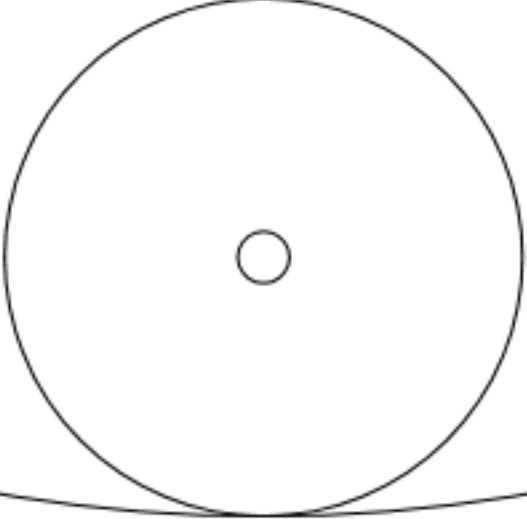
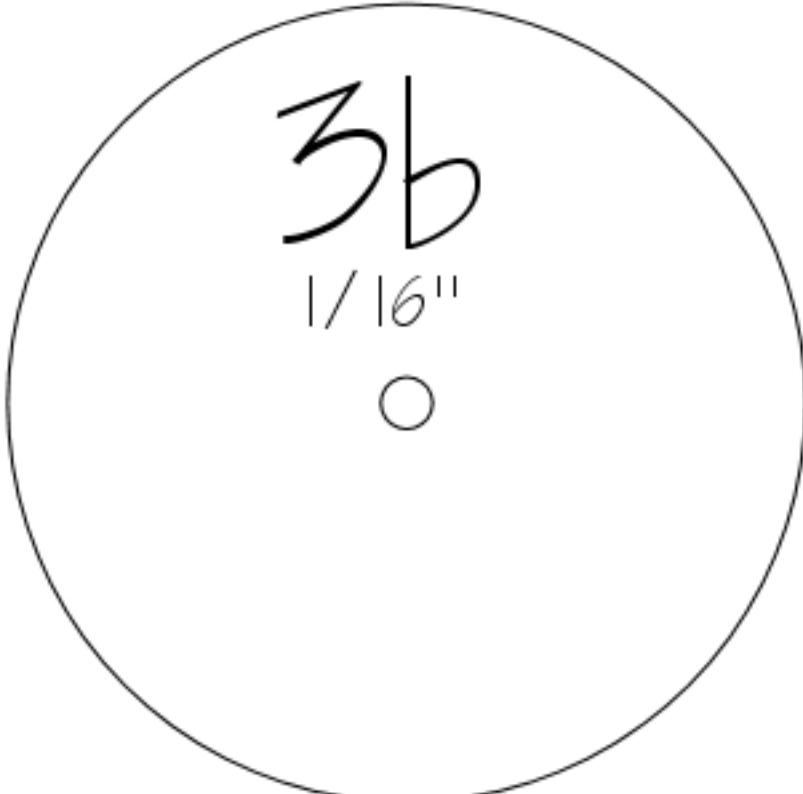

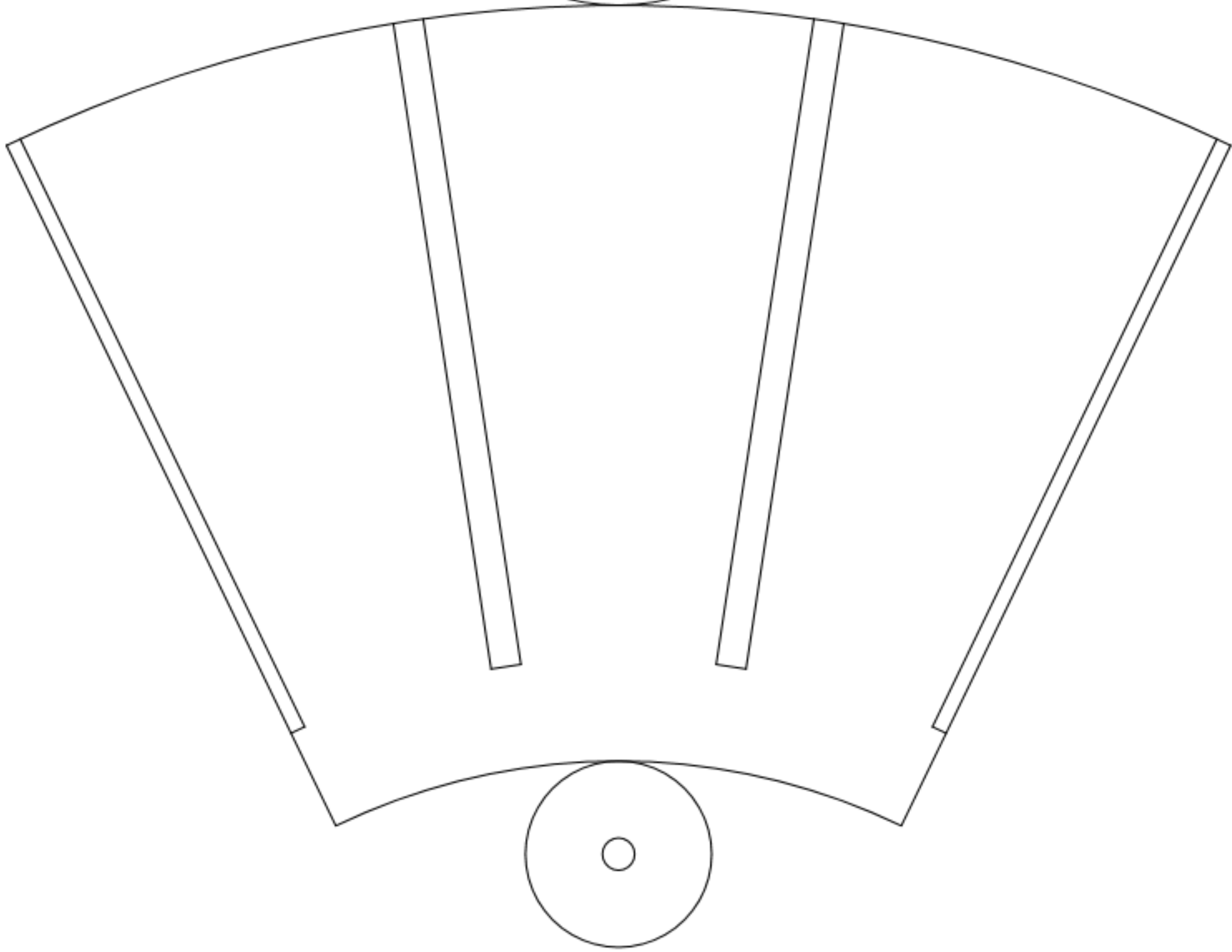
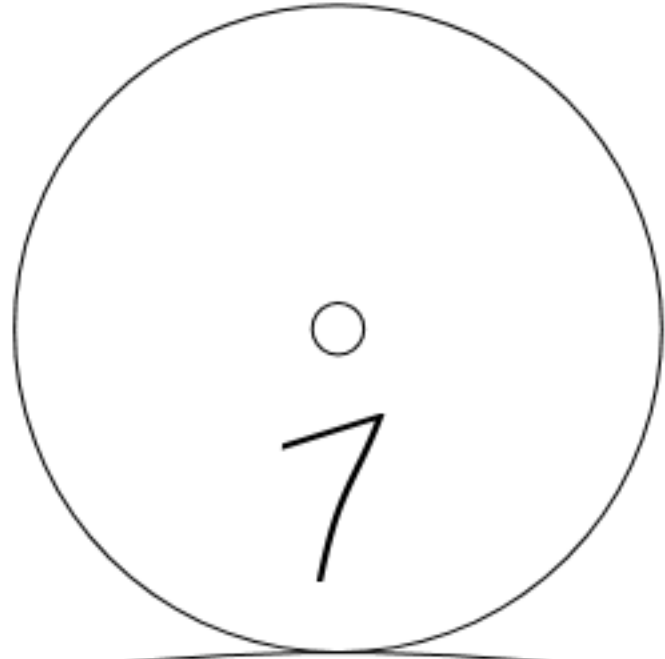

# BOTTOM CAP

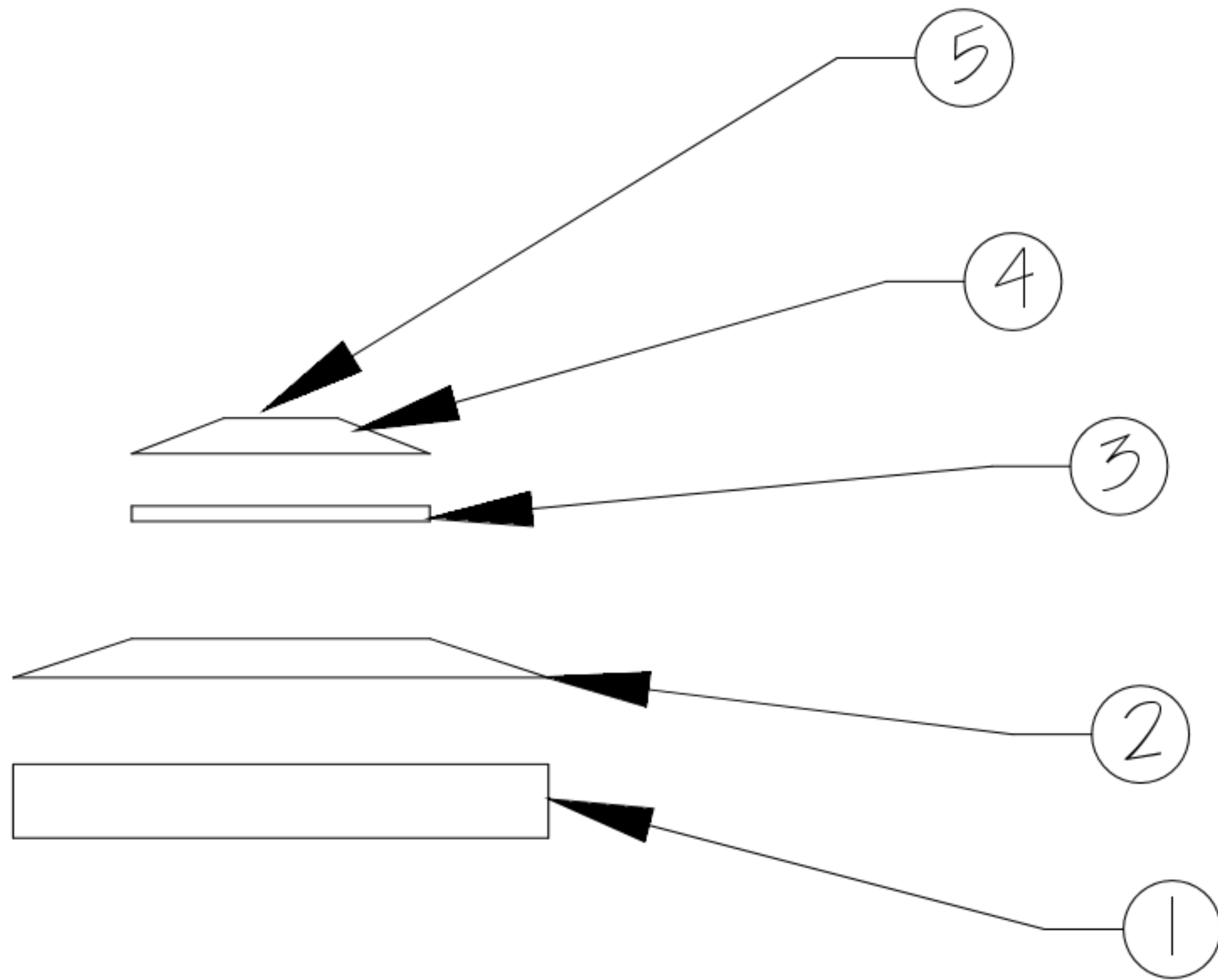
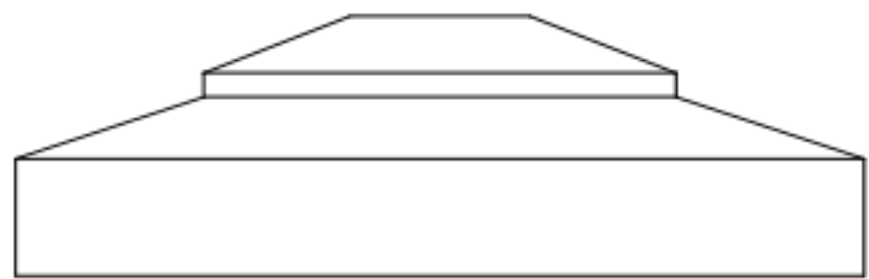
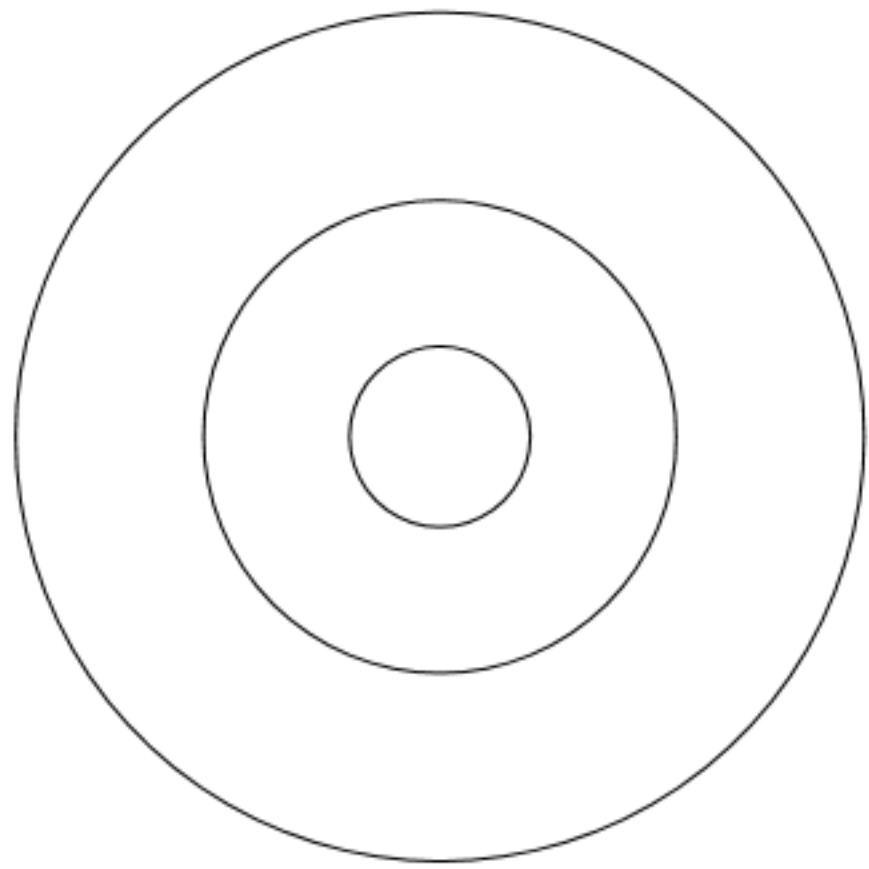

# BOTTOM CAP

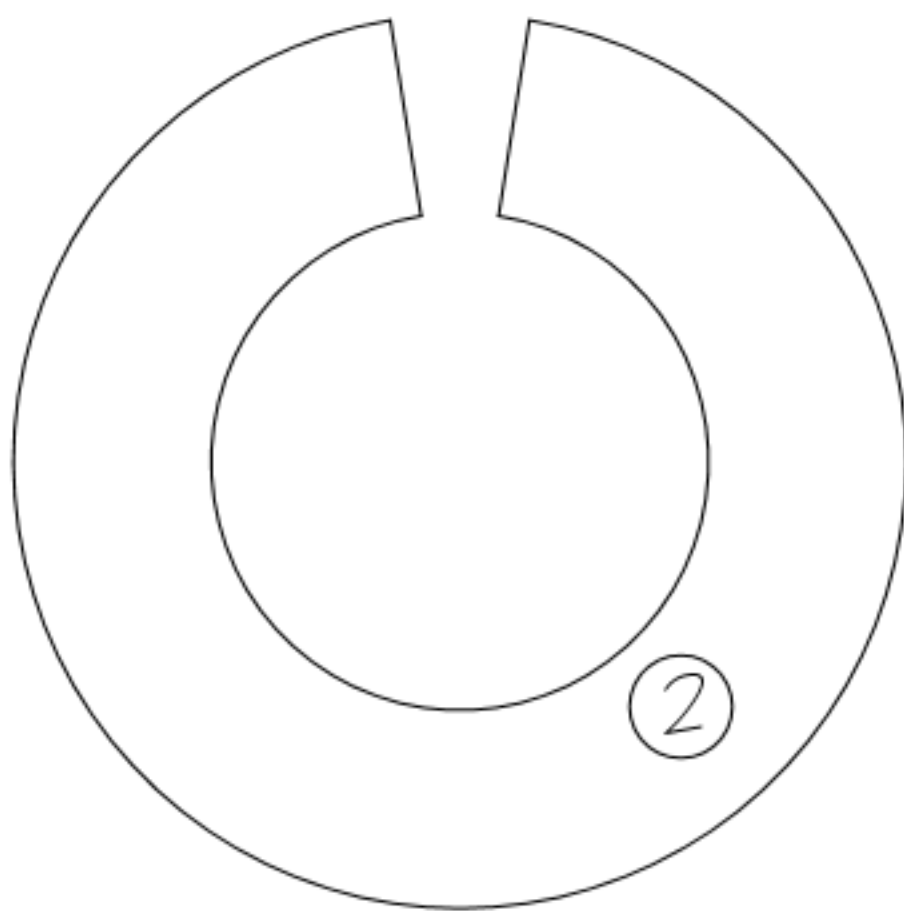

# TOP CAP

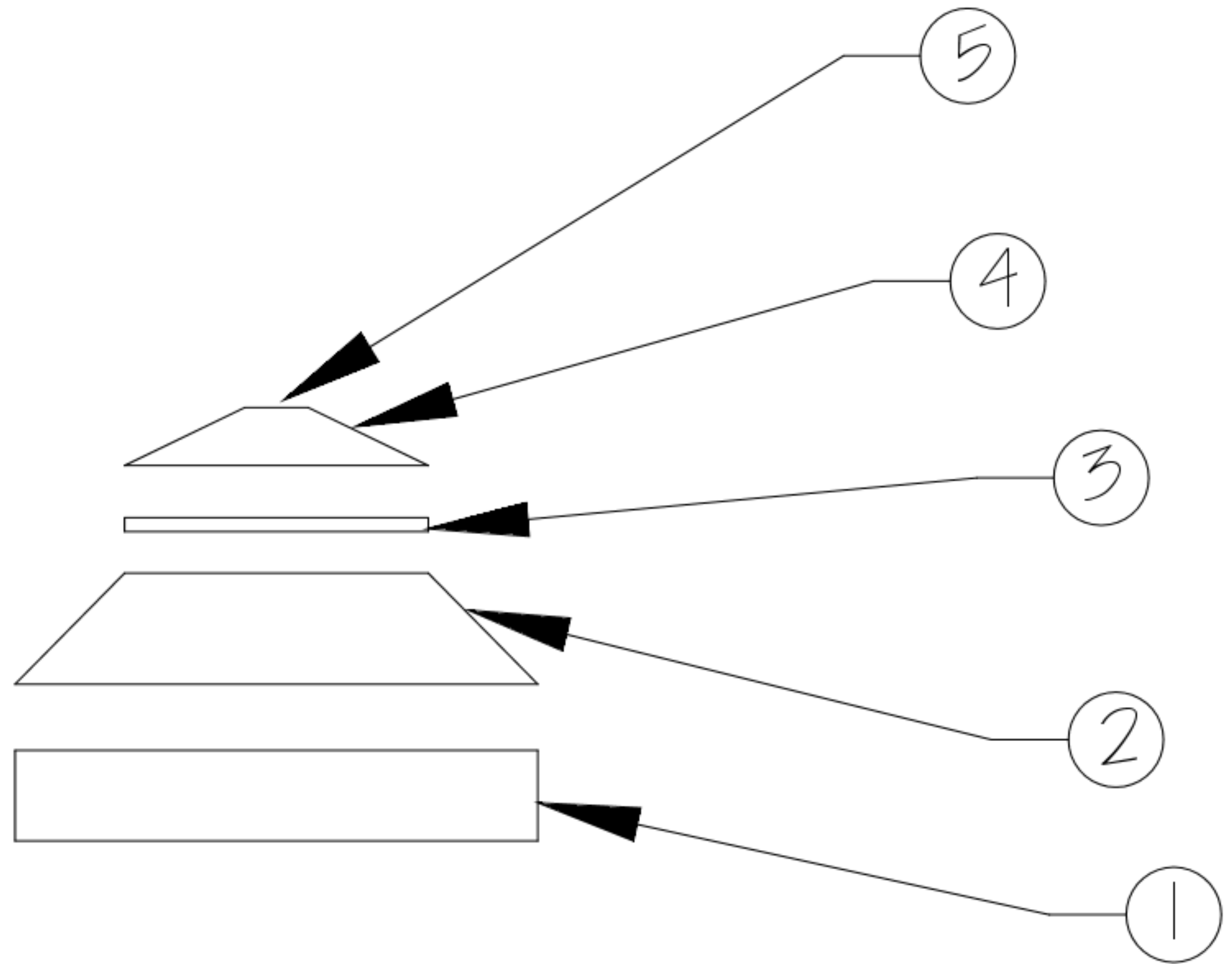
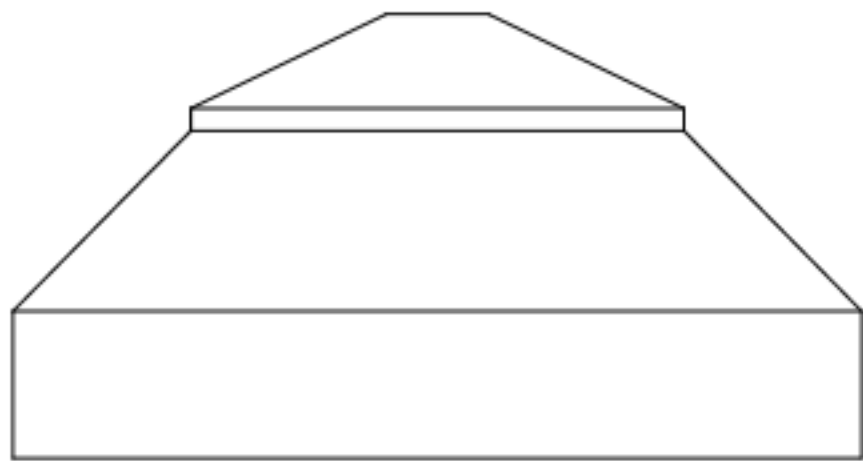
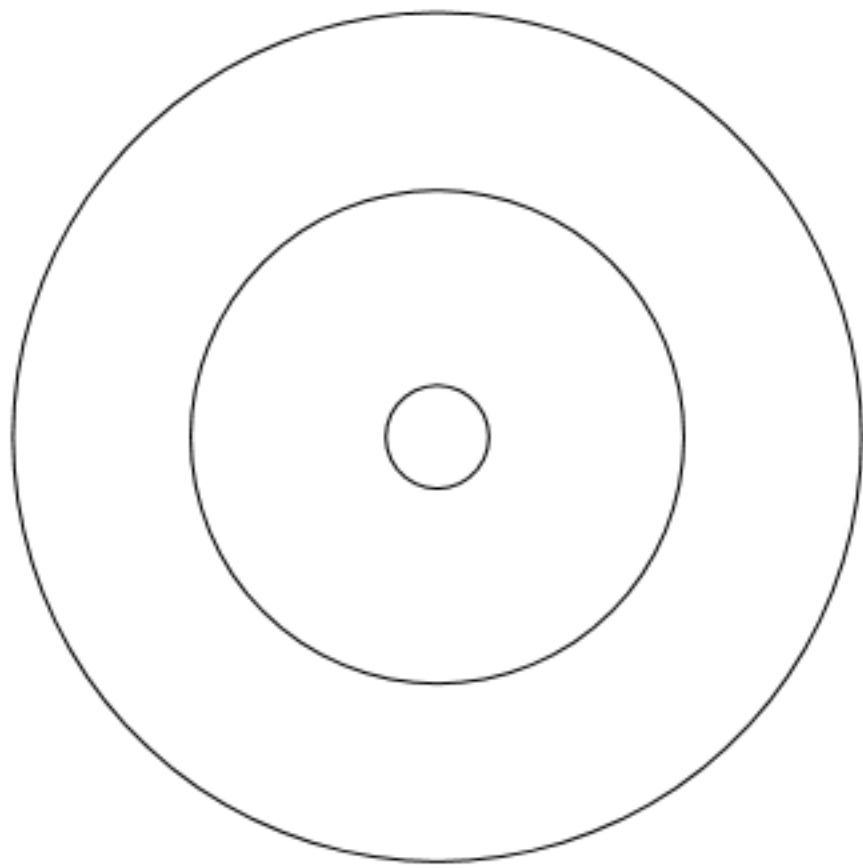

# TOP CAP

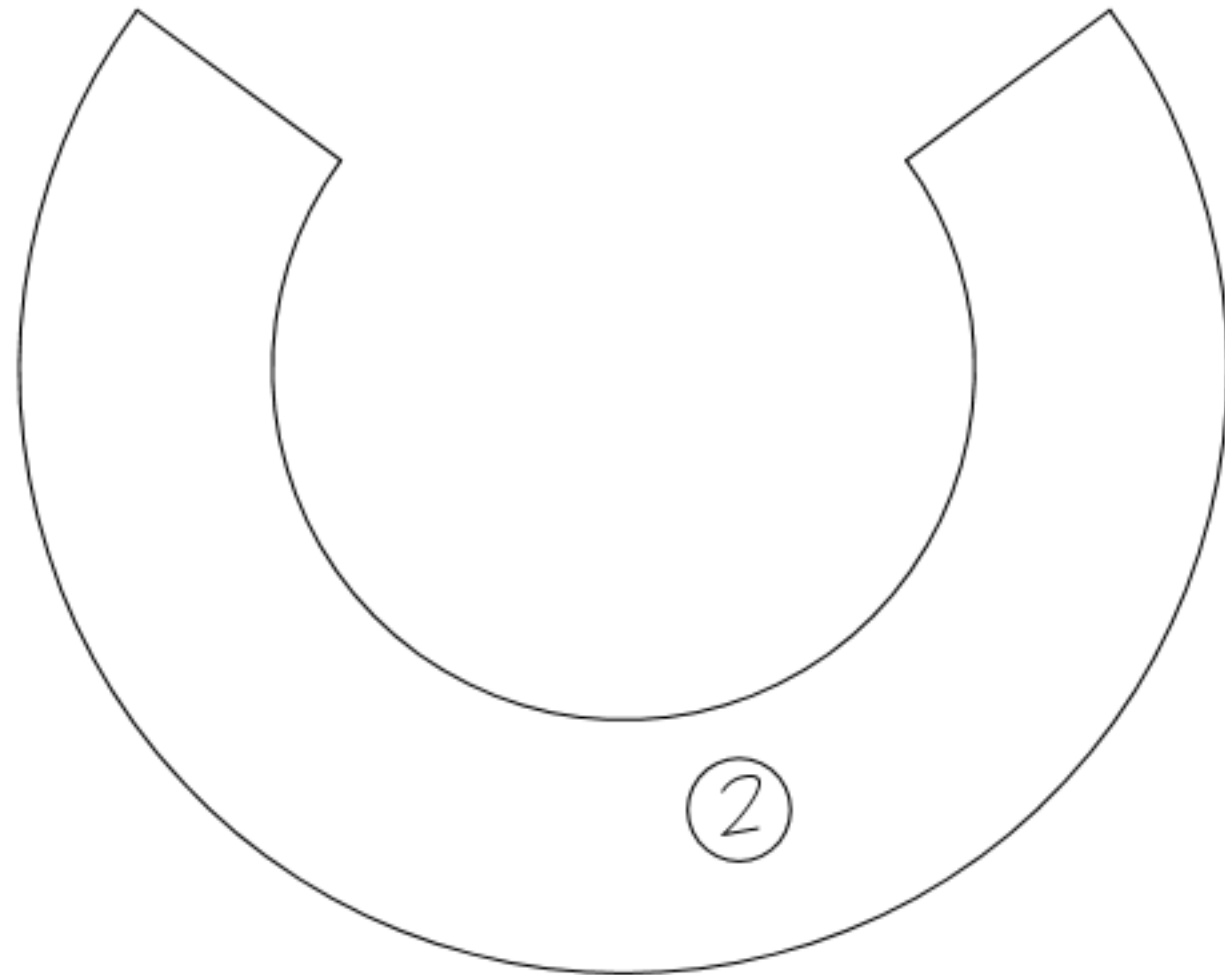
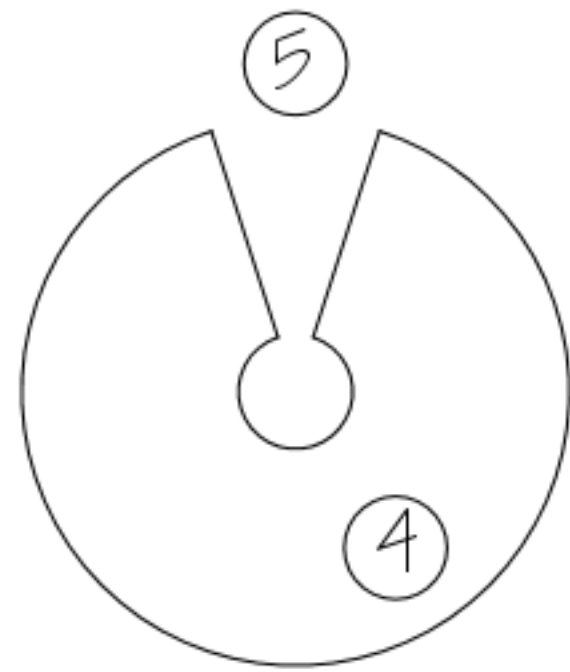

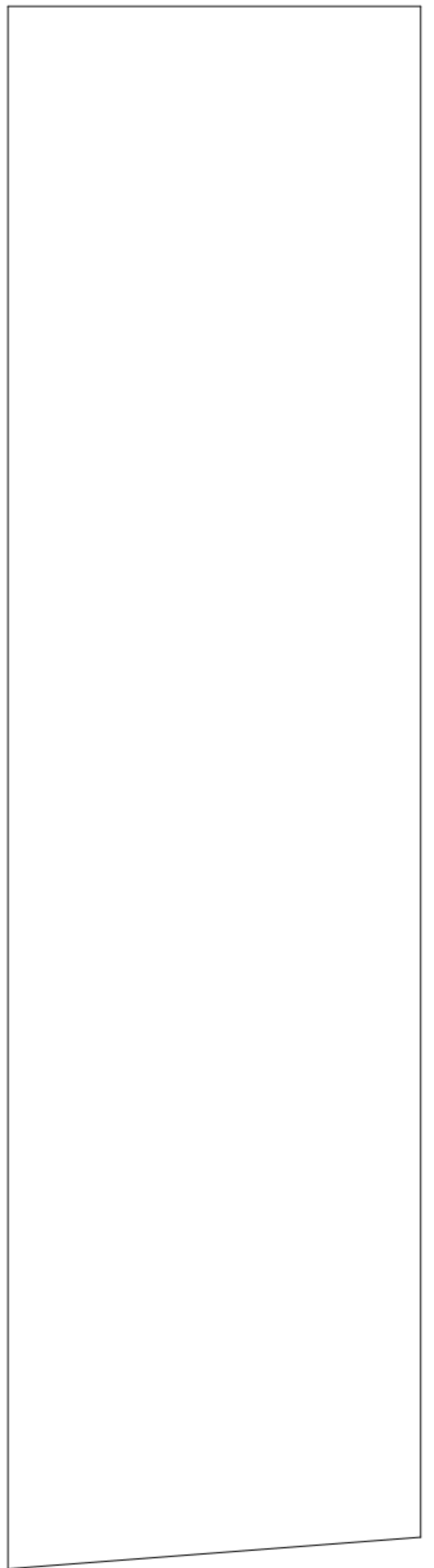
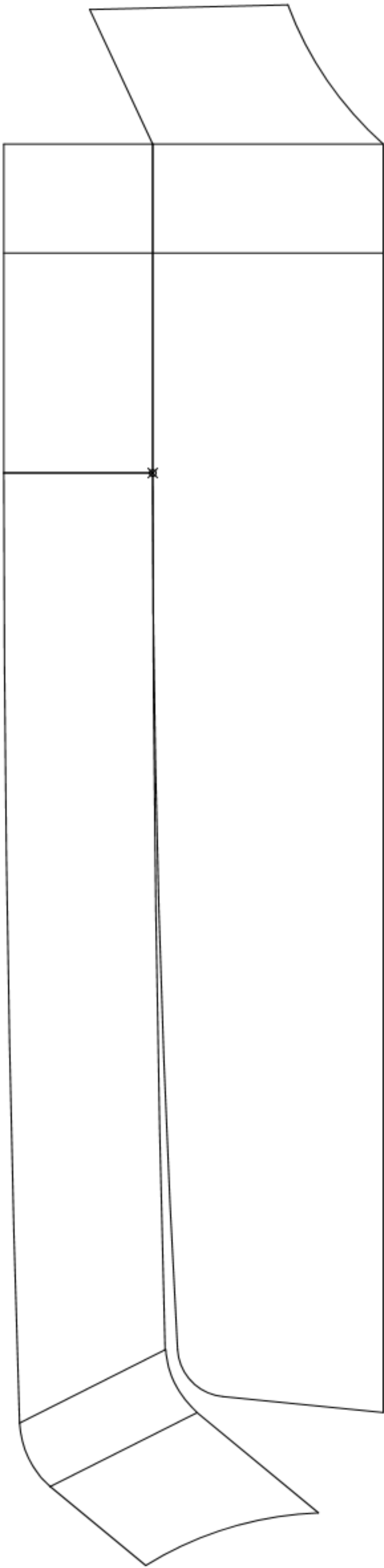

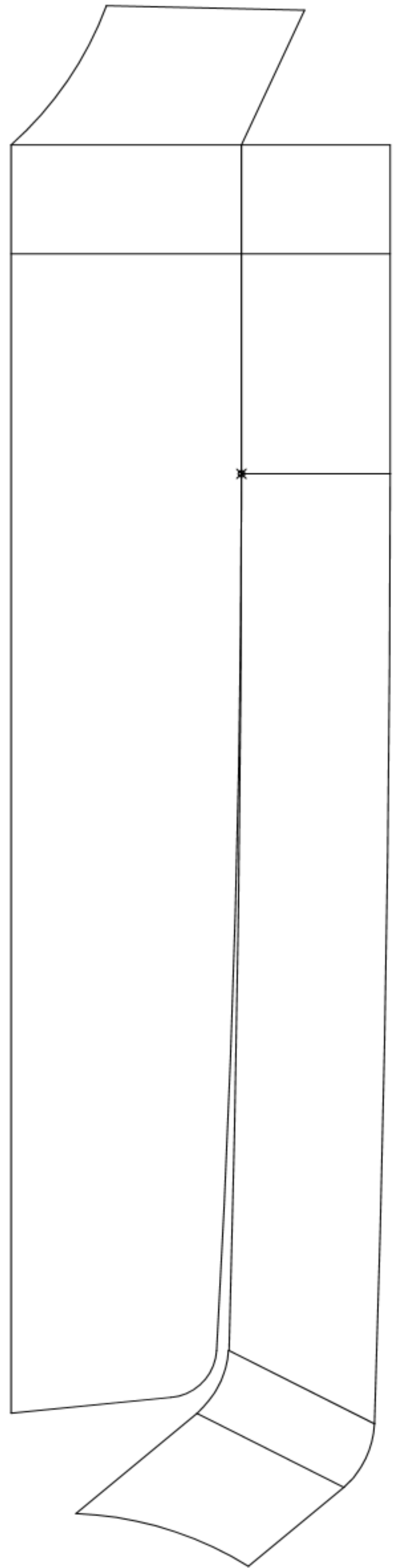
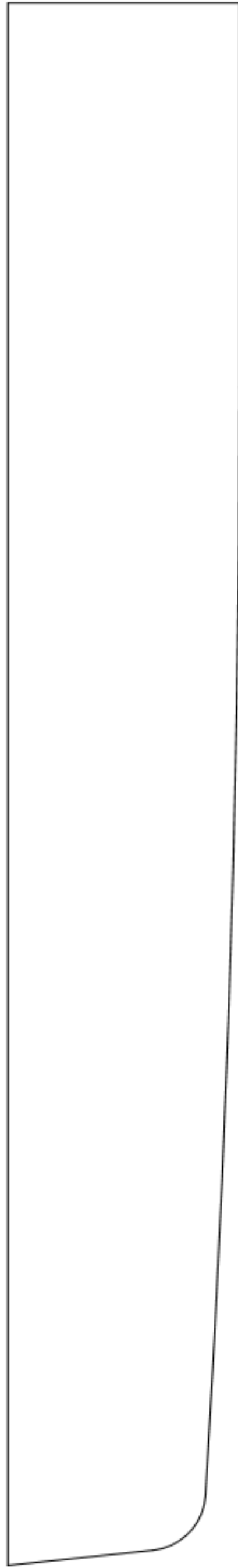
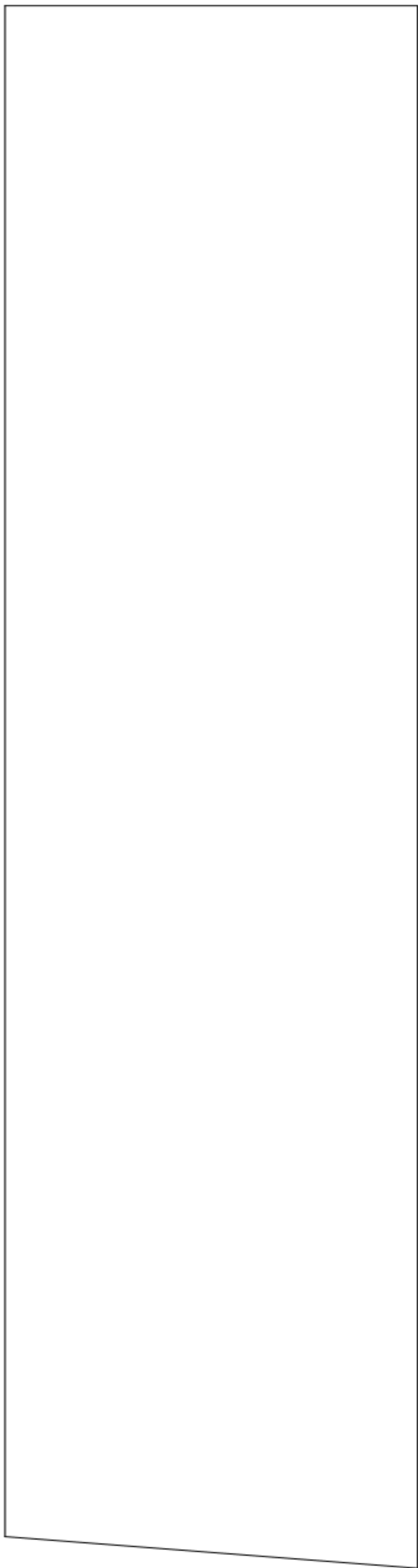



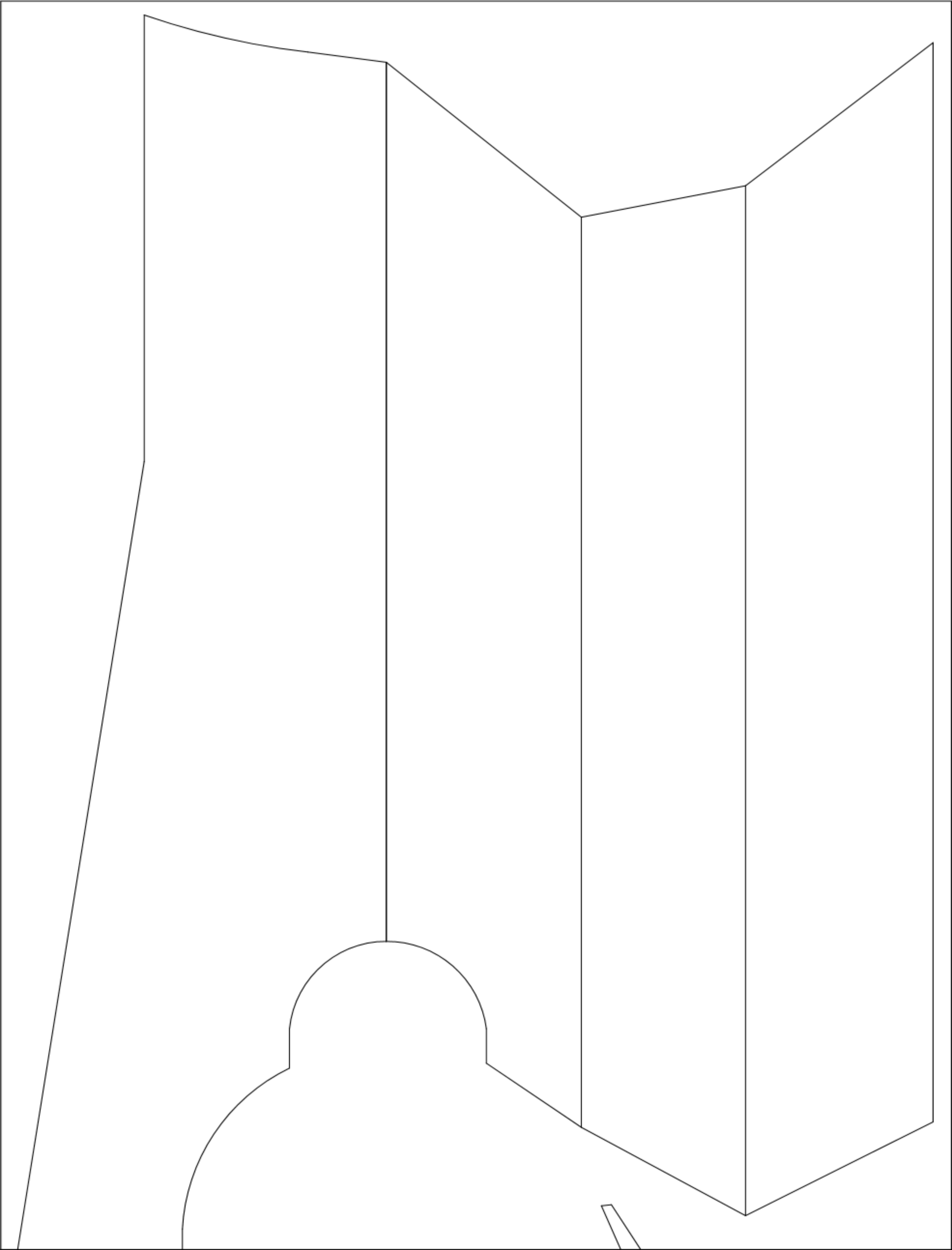

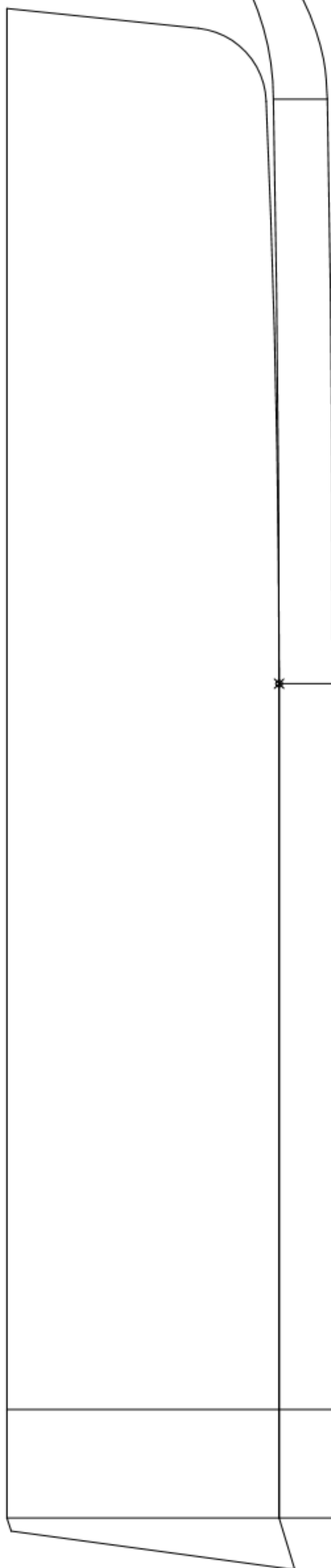
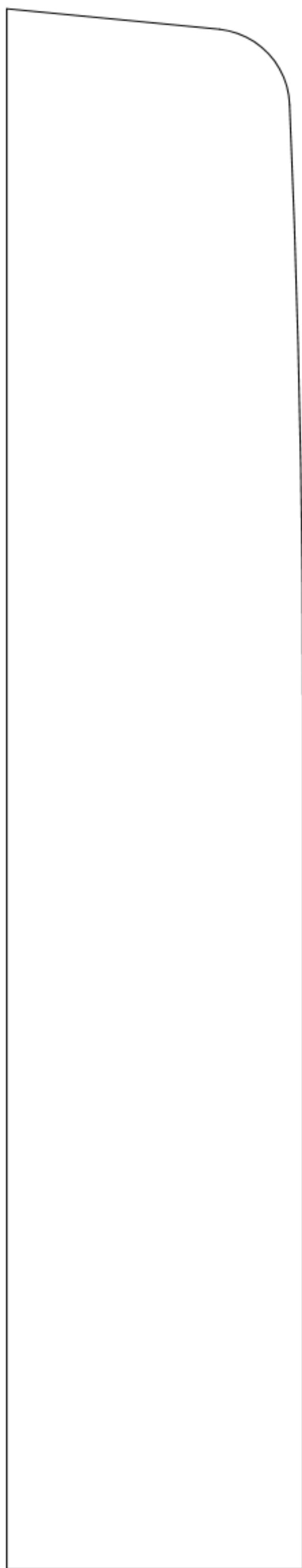

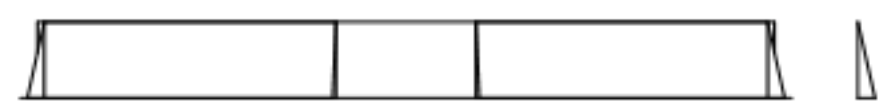
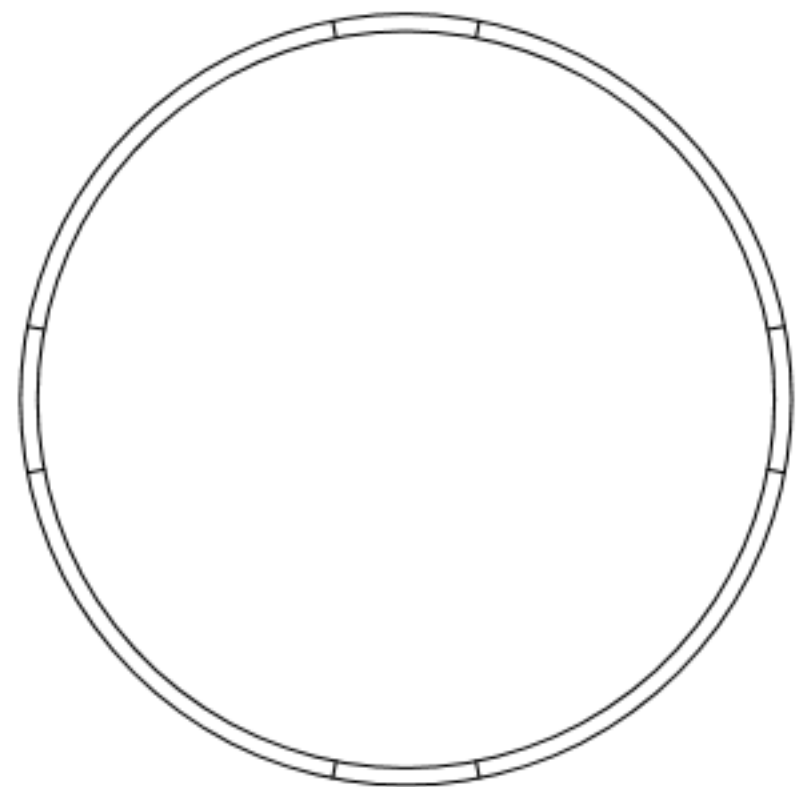
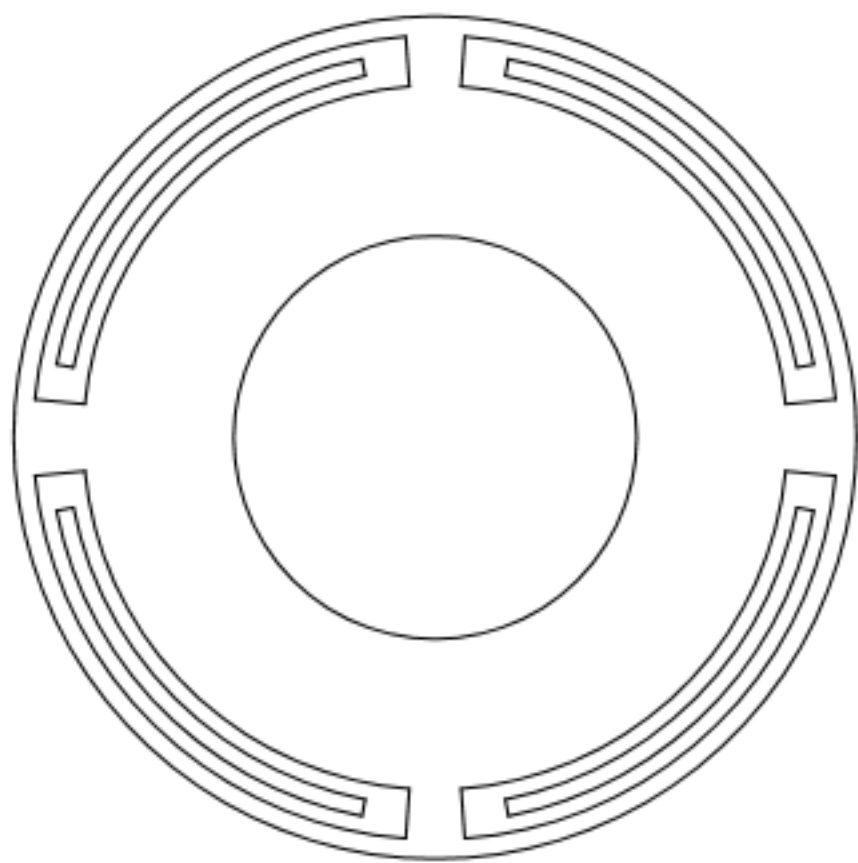
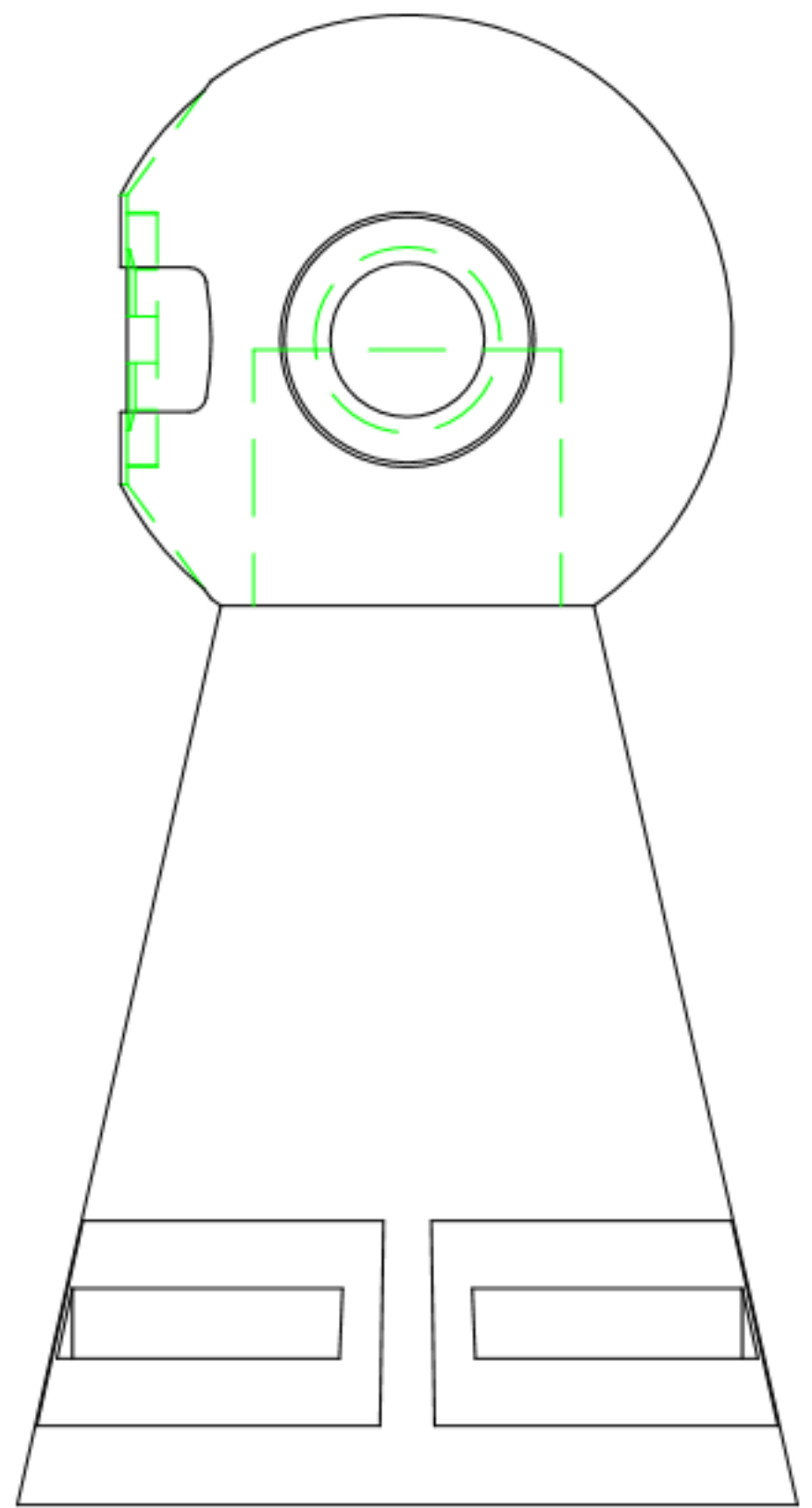
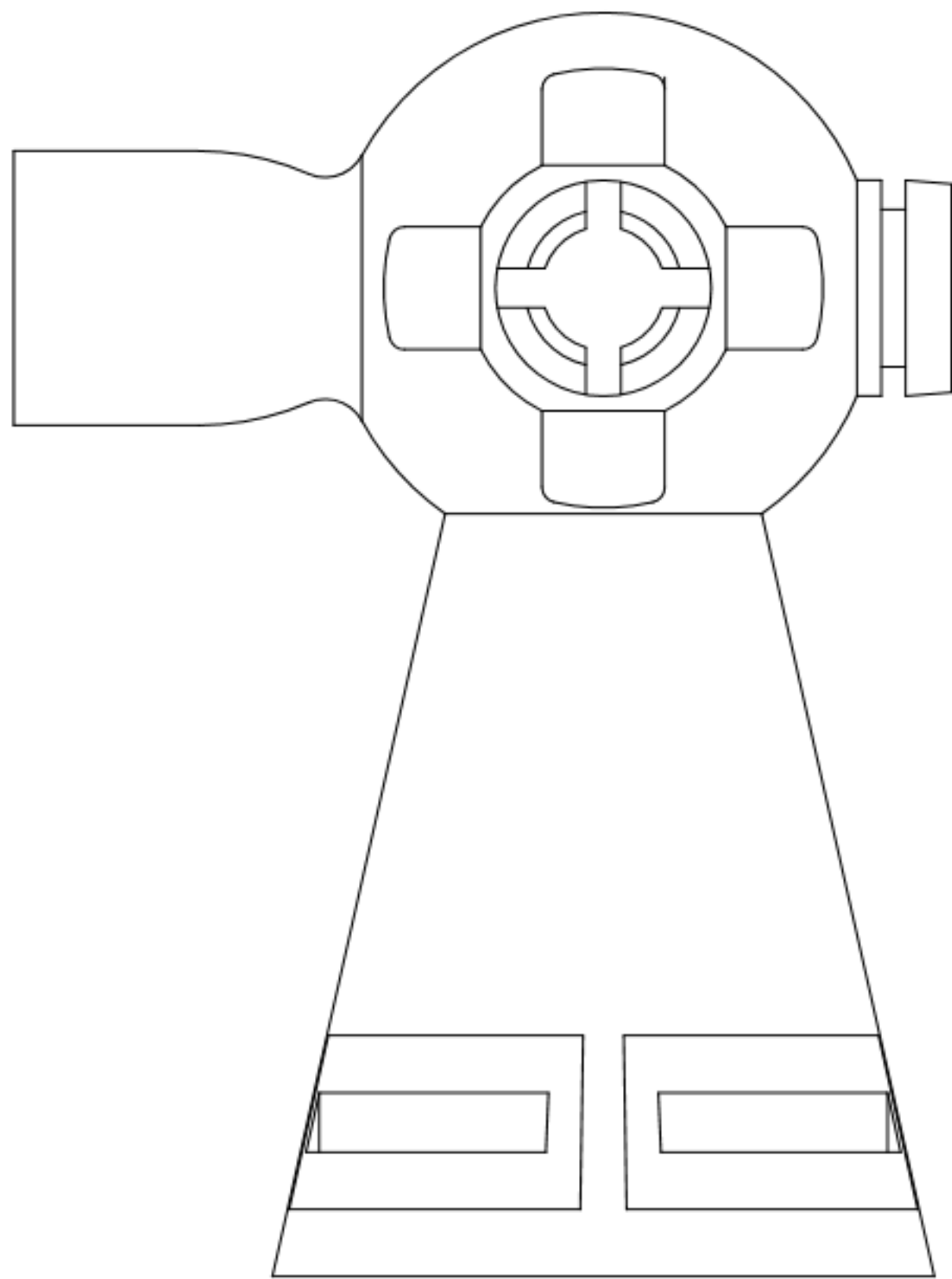

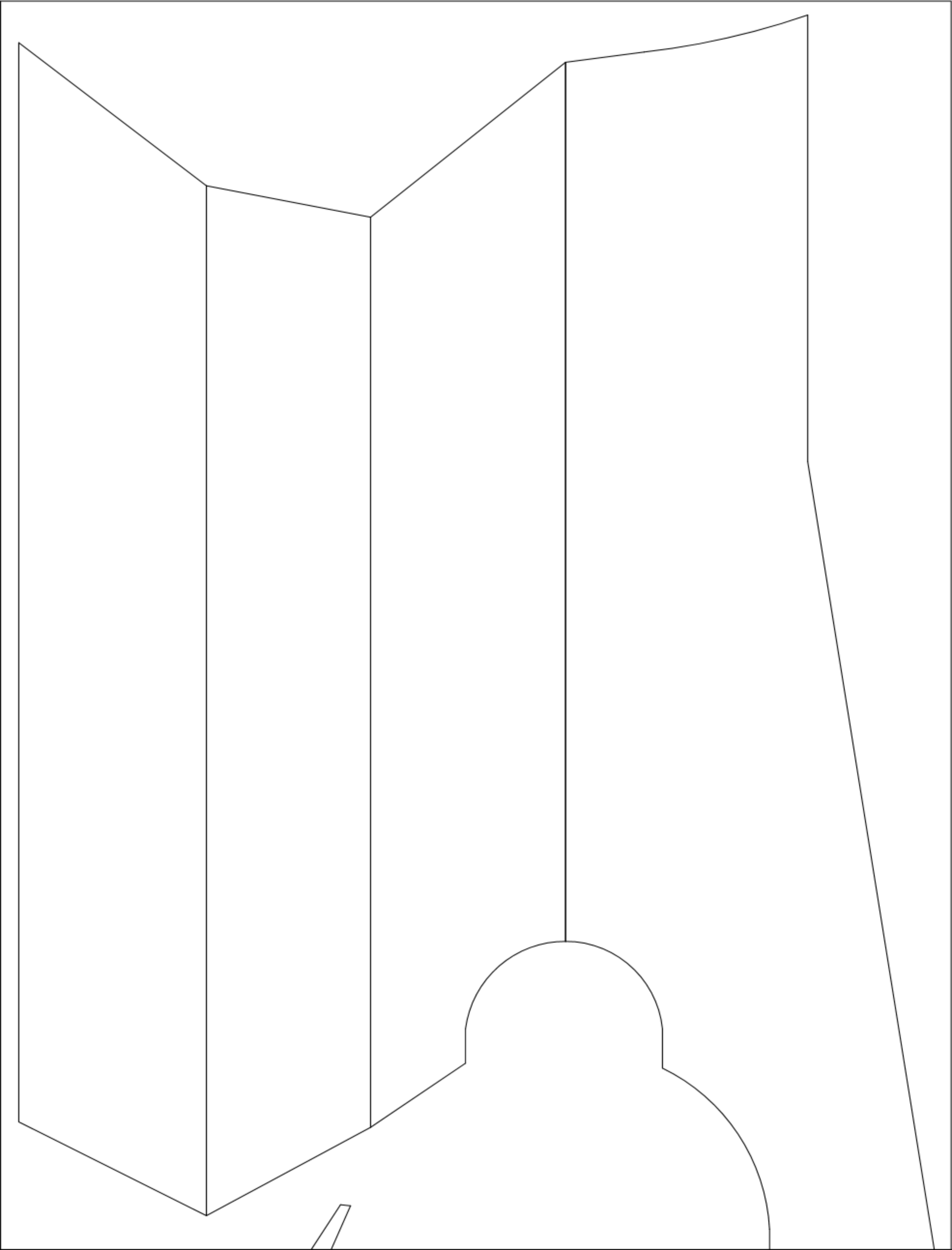

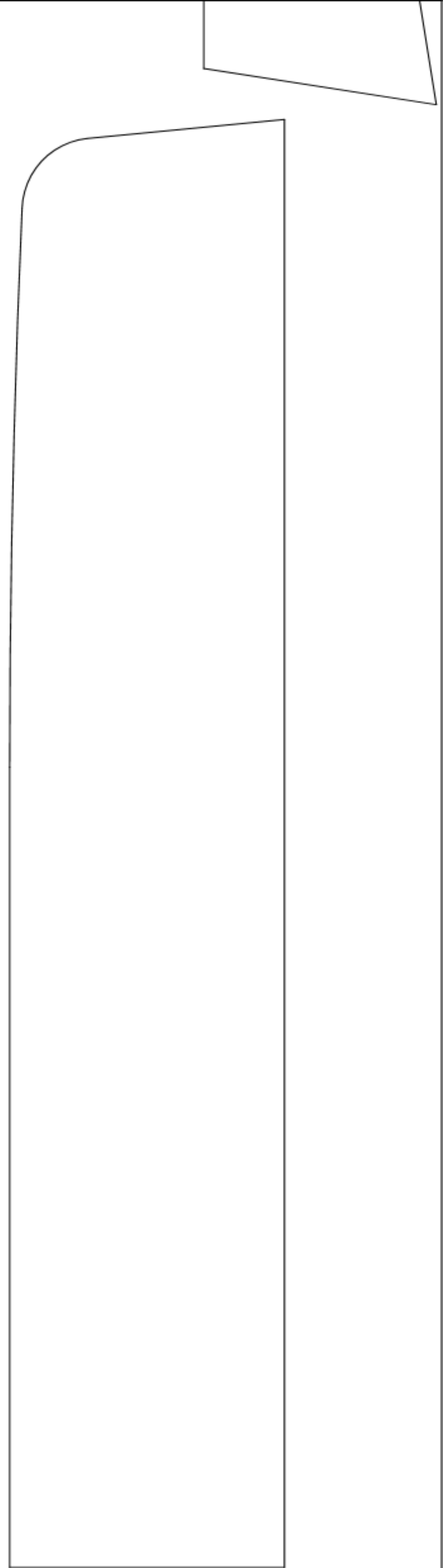
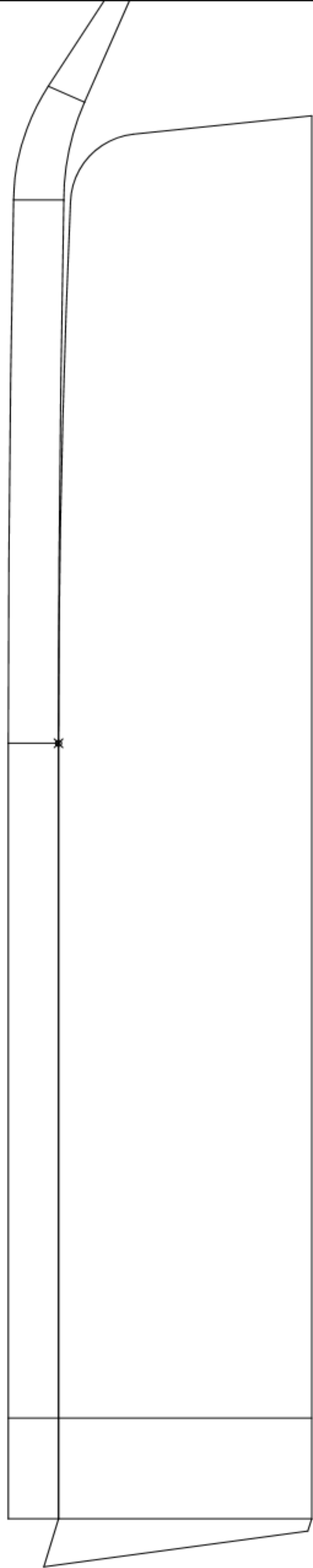

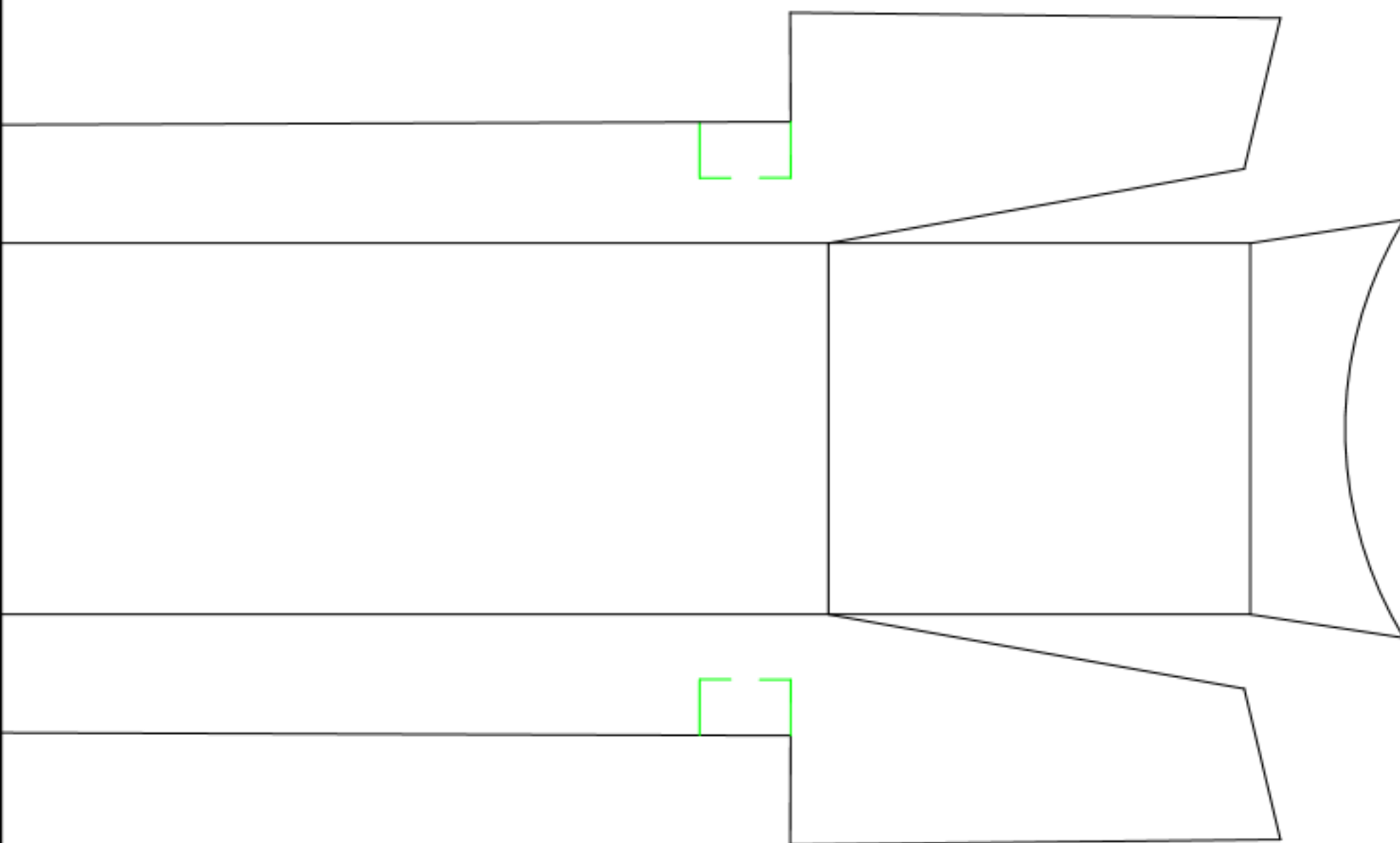
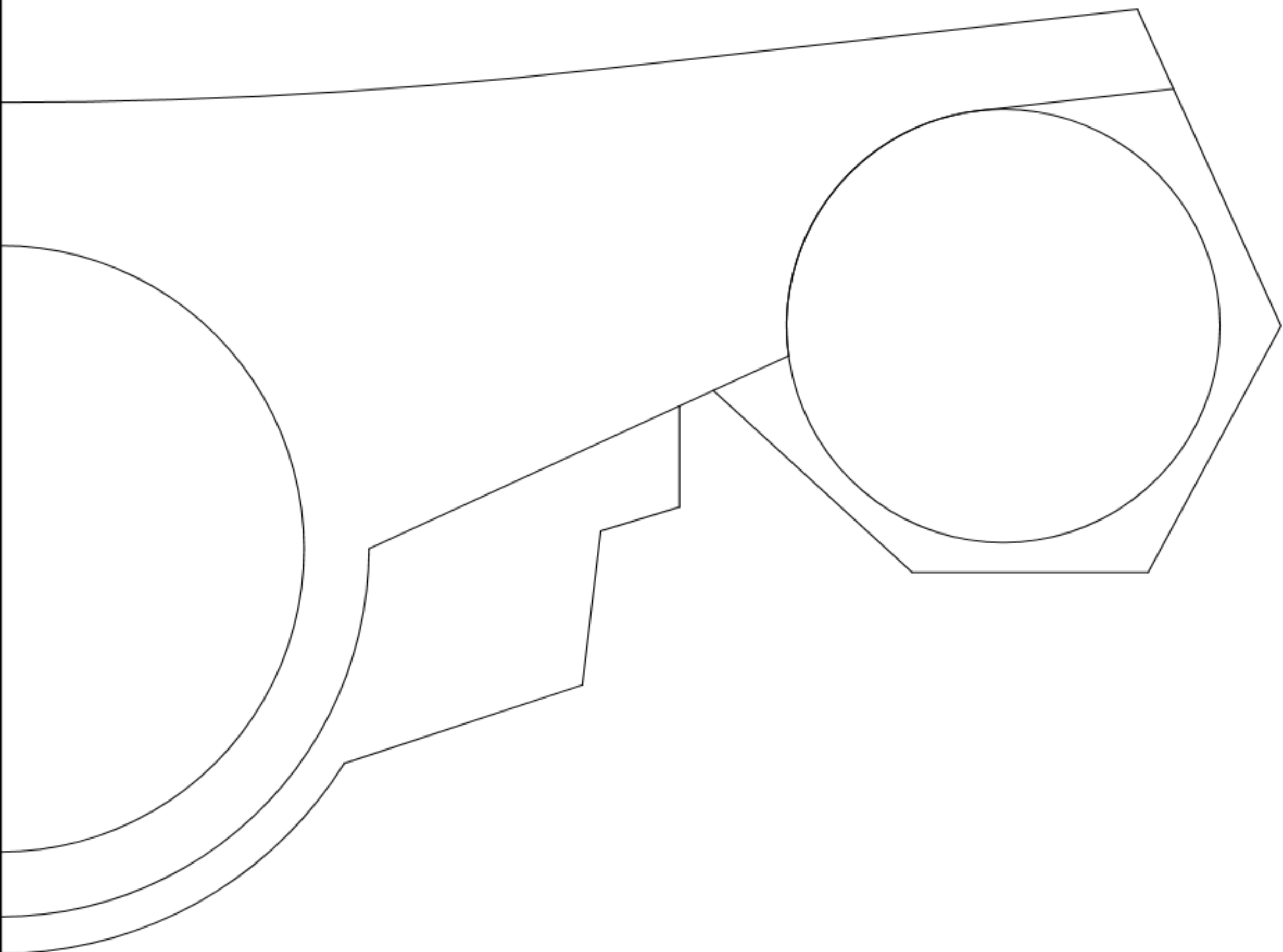

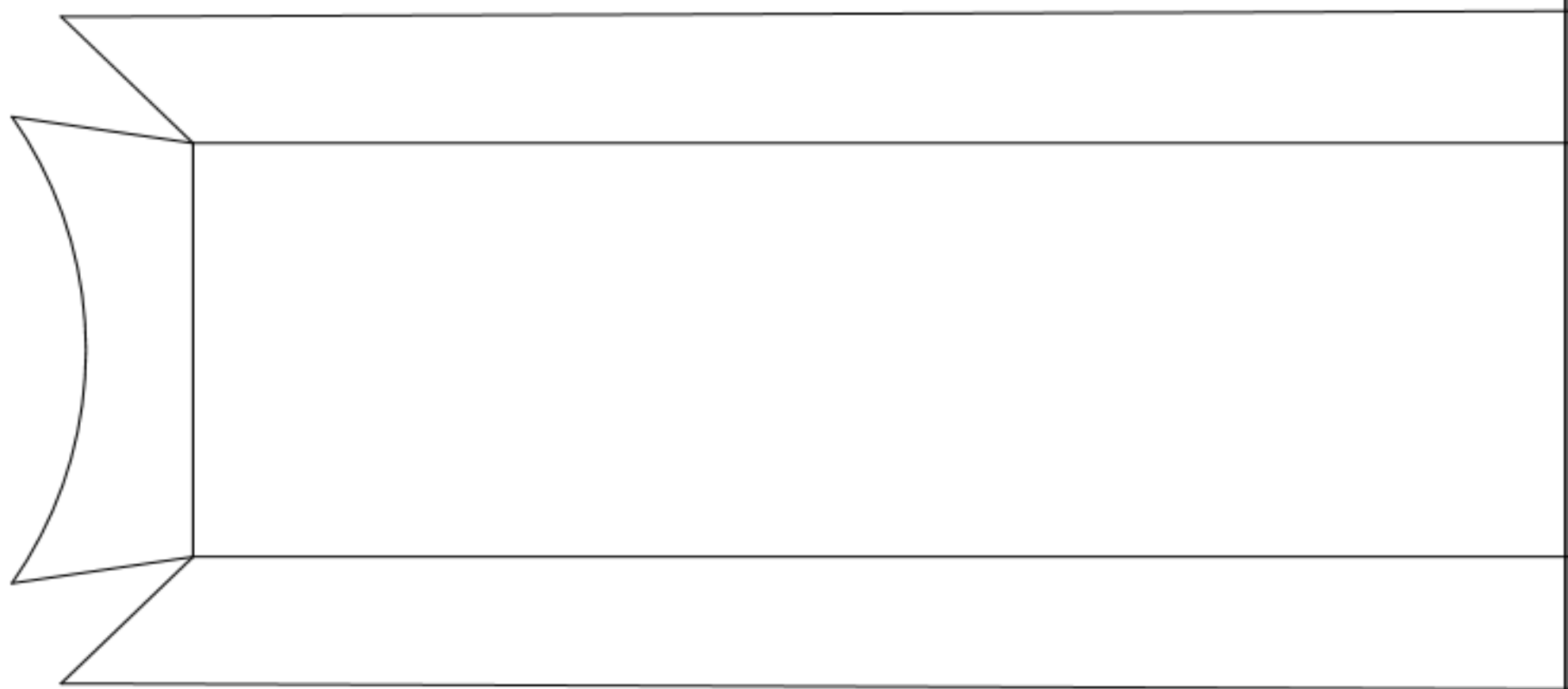
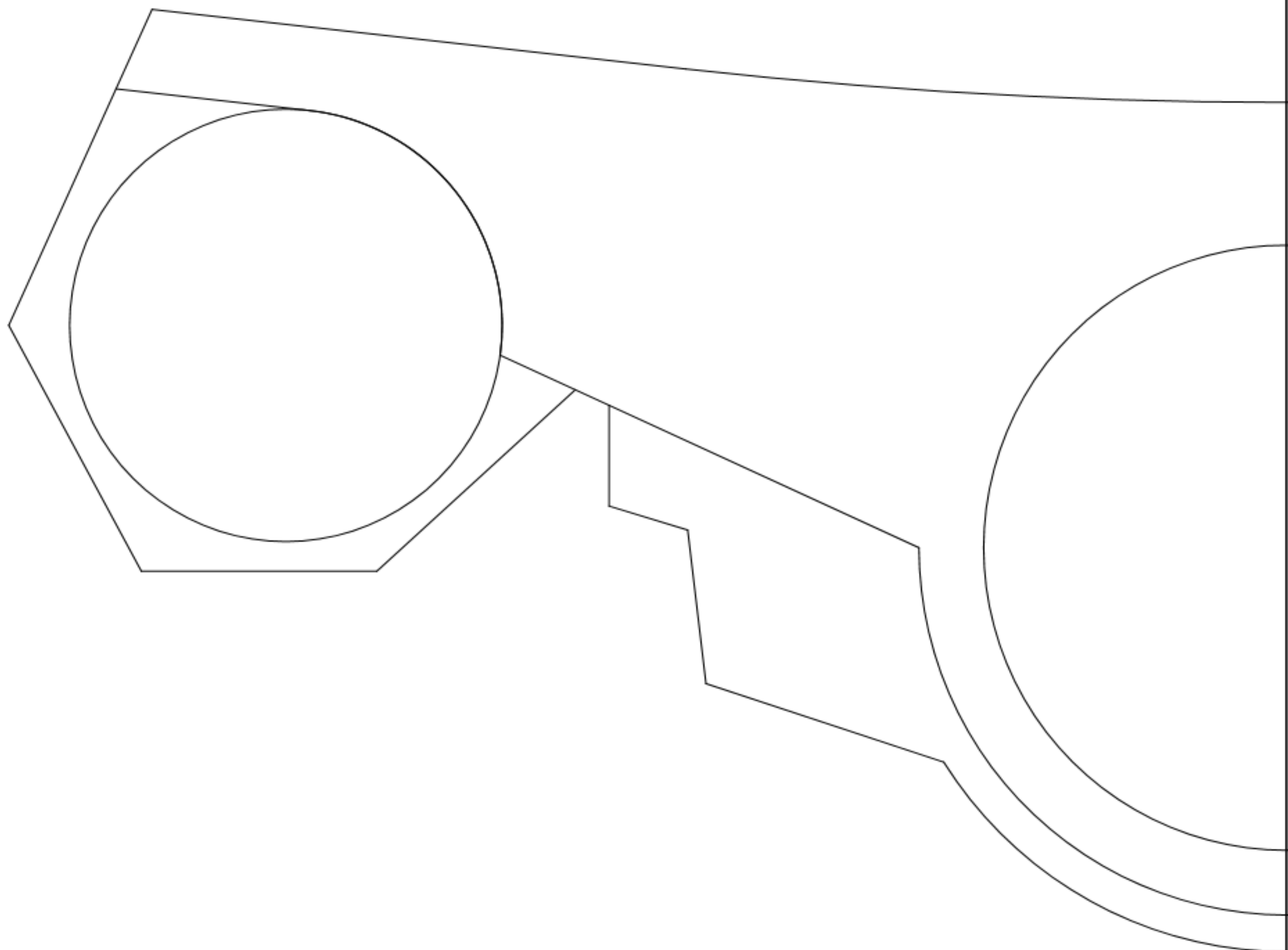

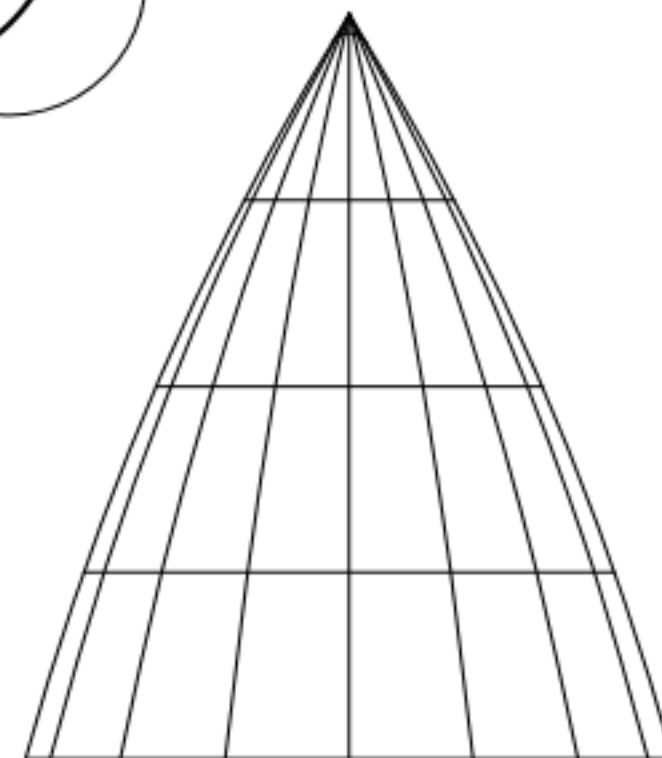
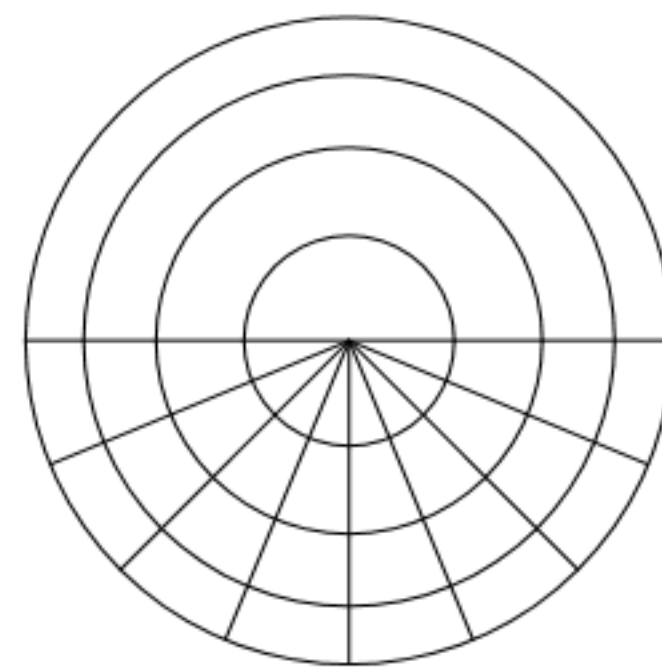
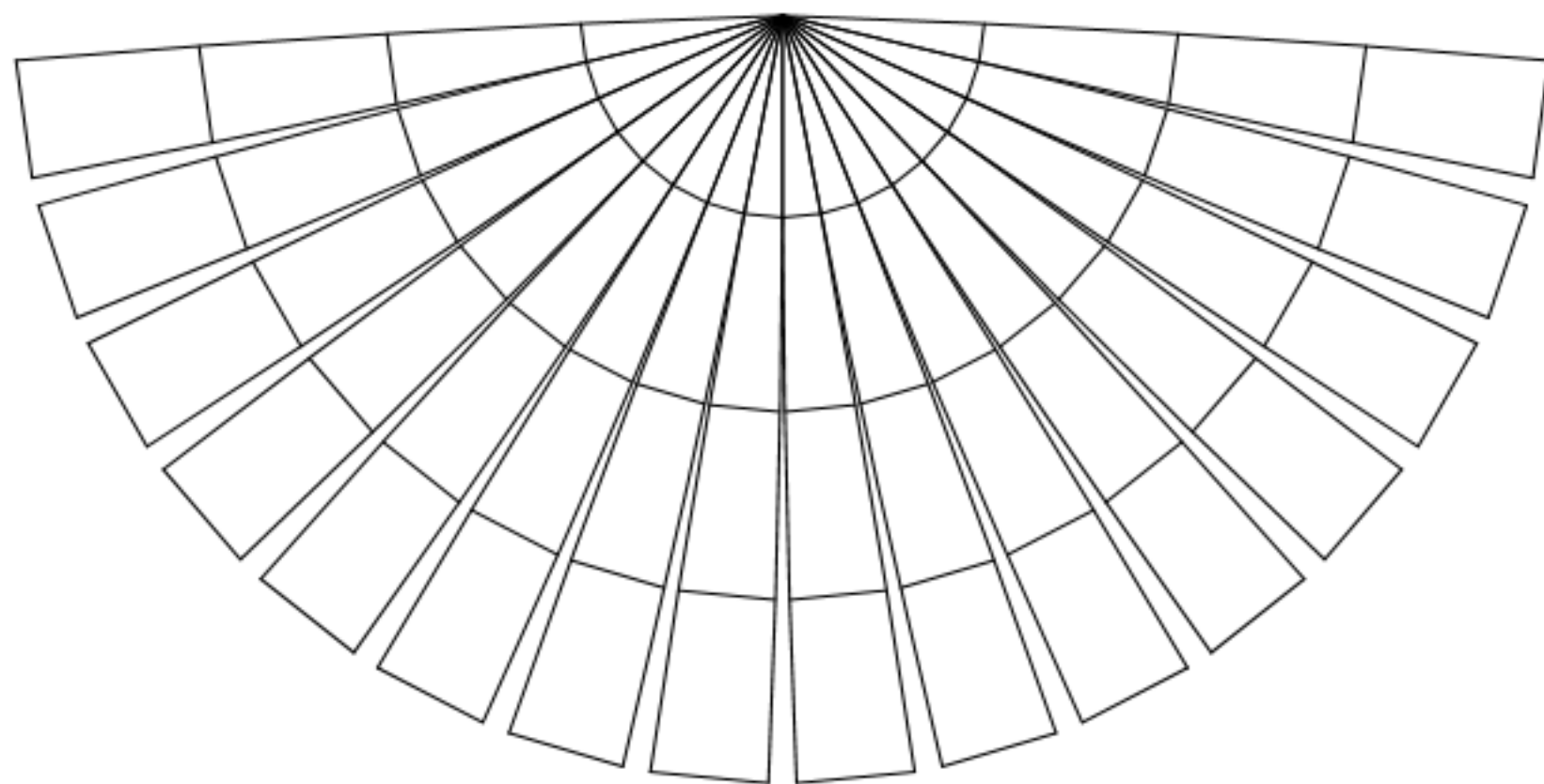
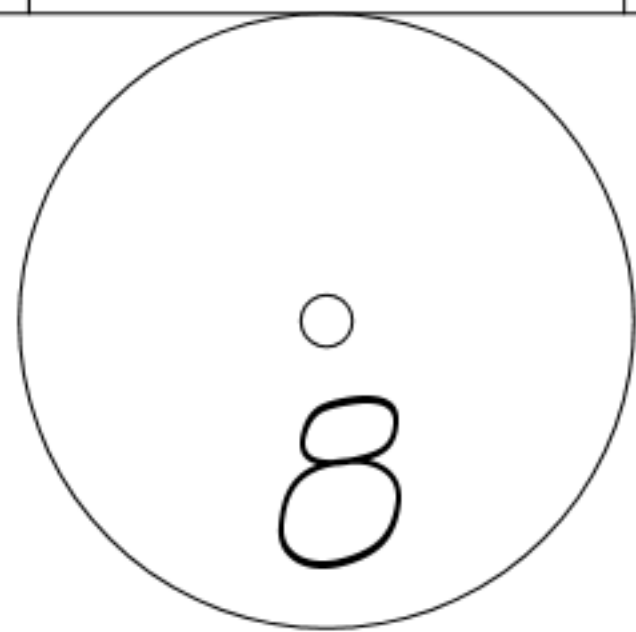
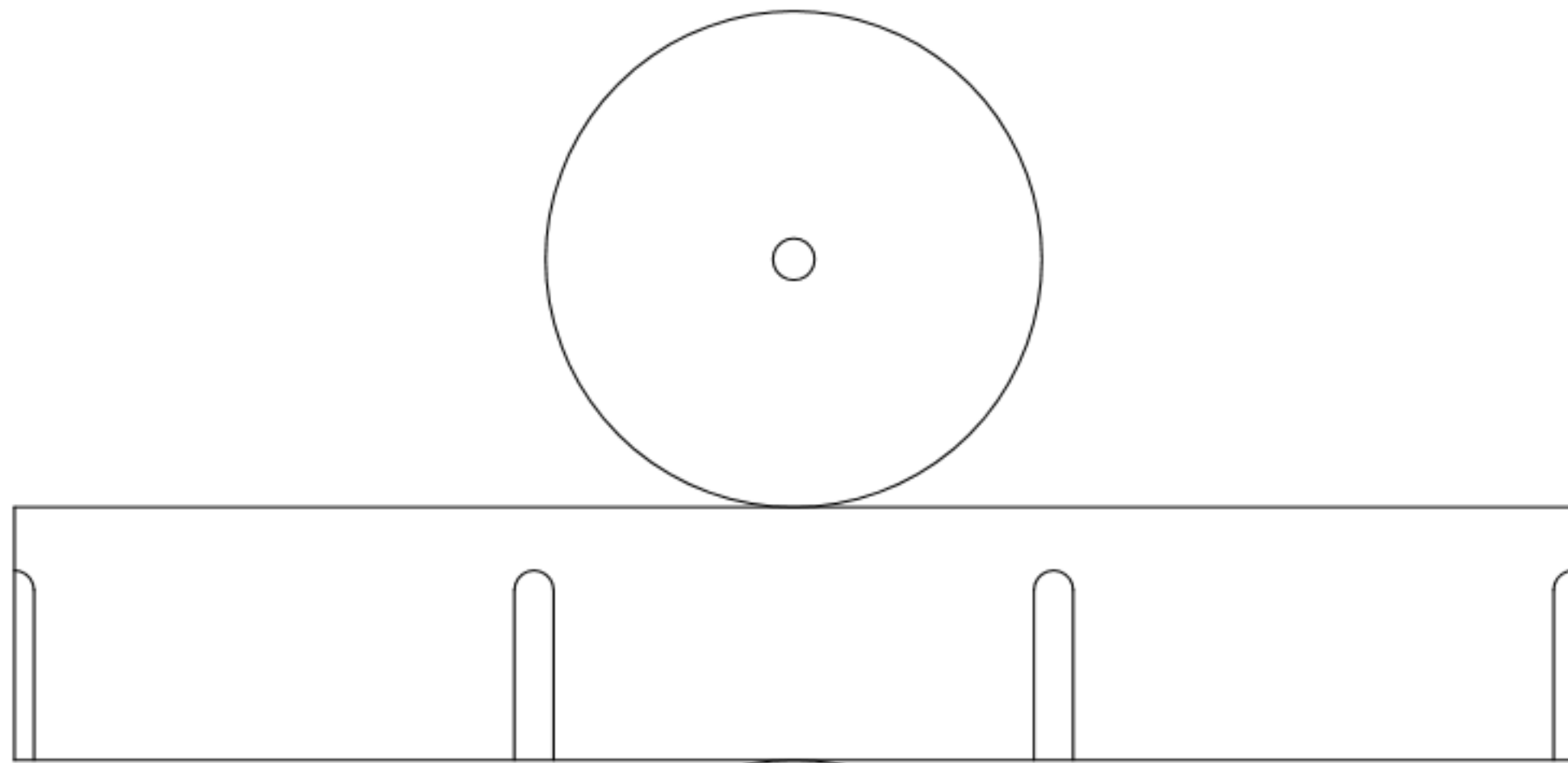



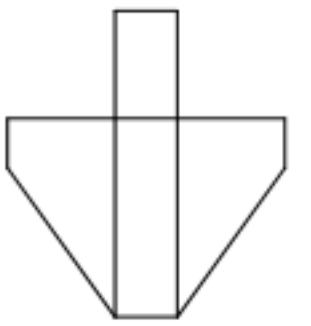
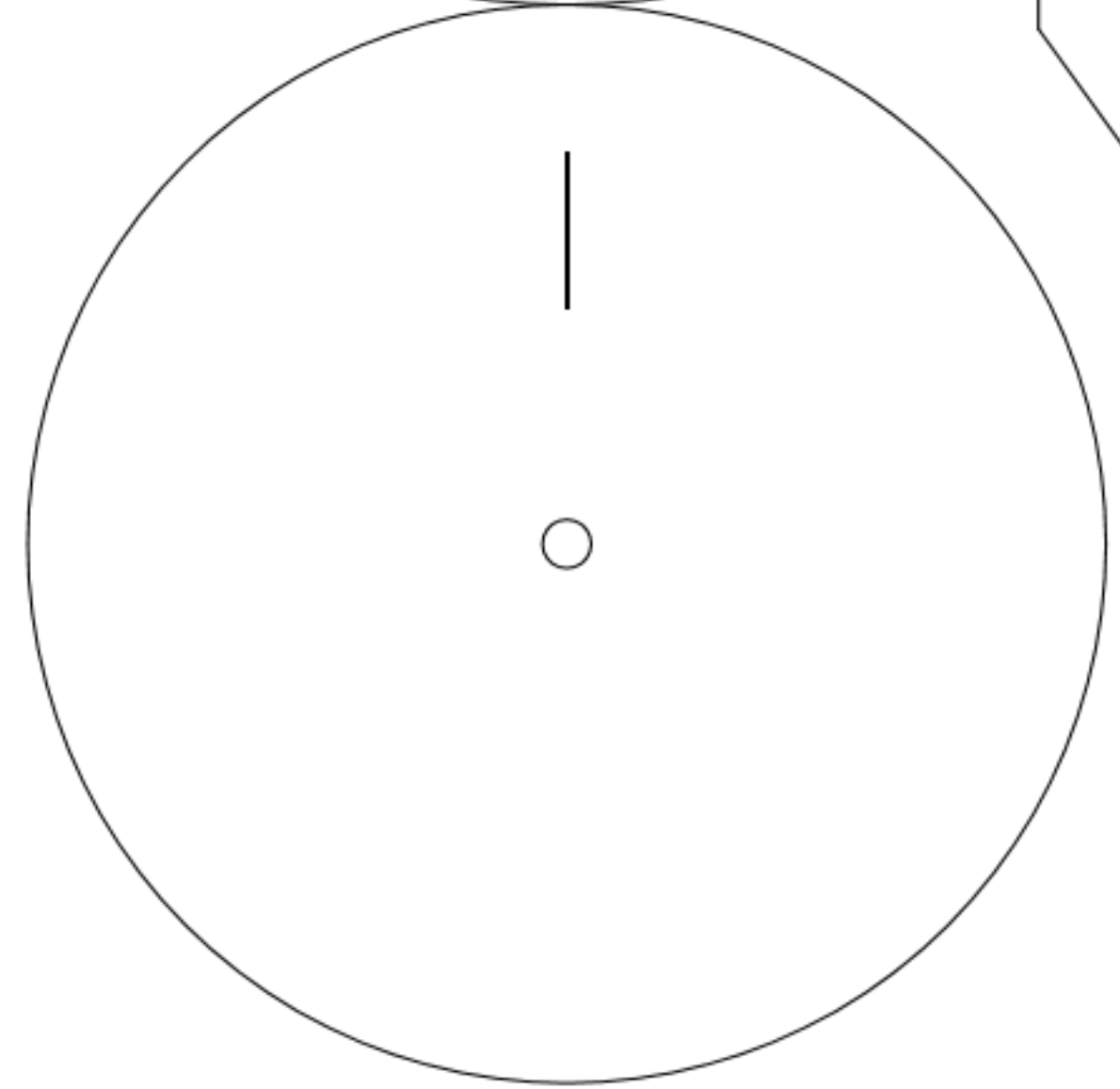
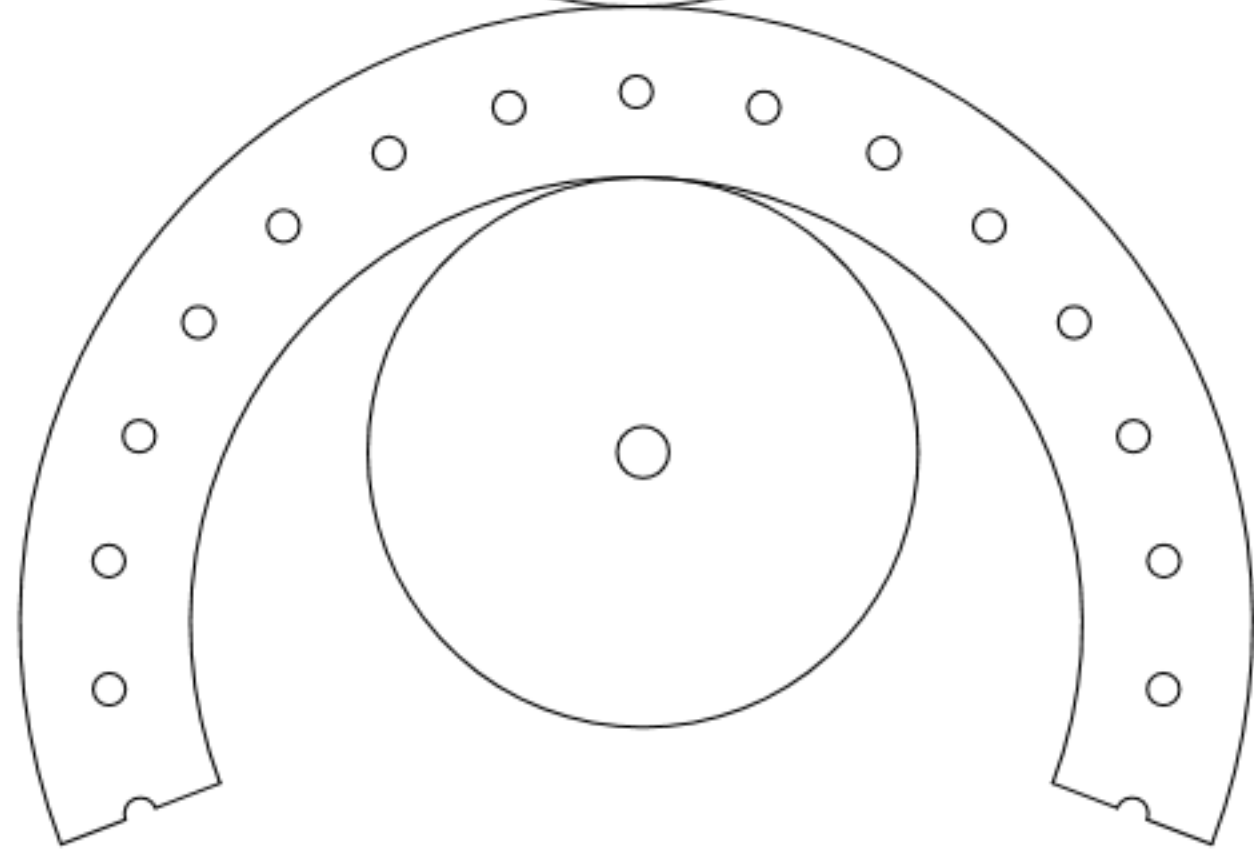
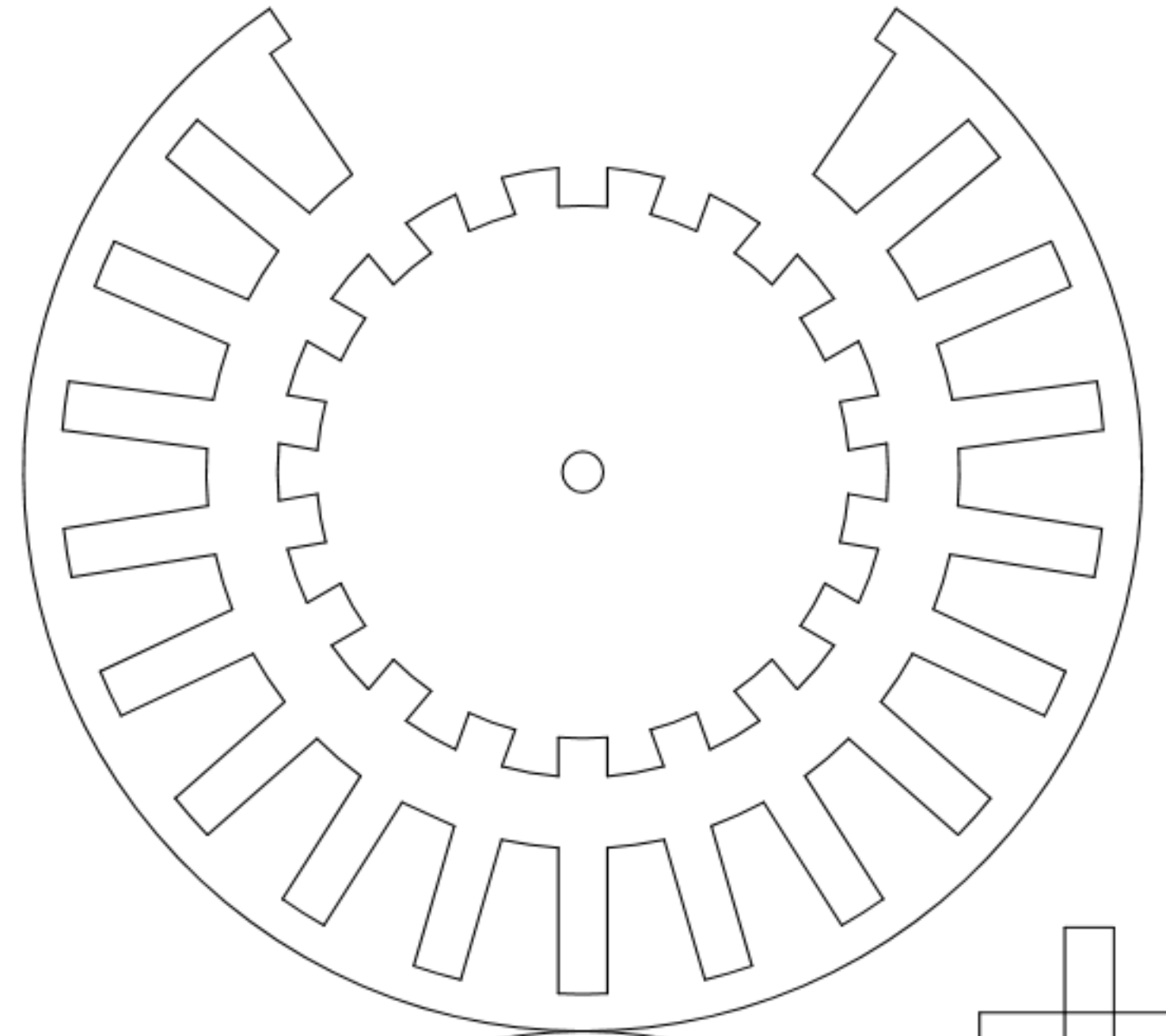
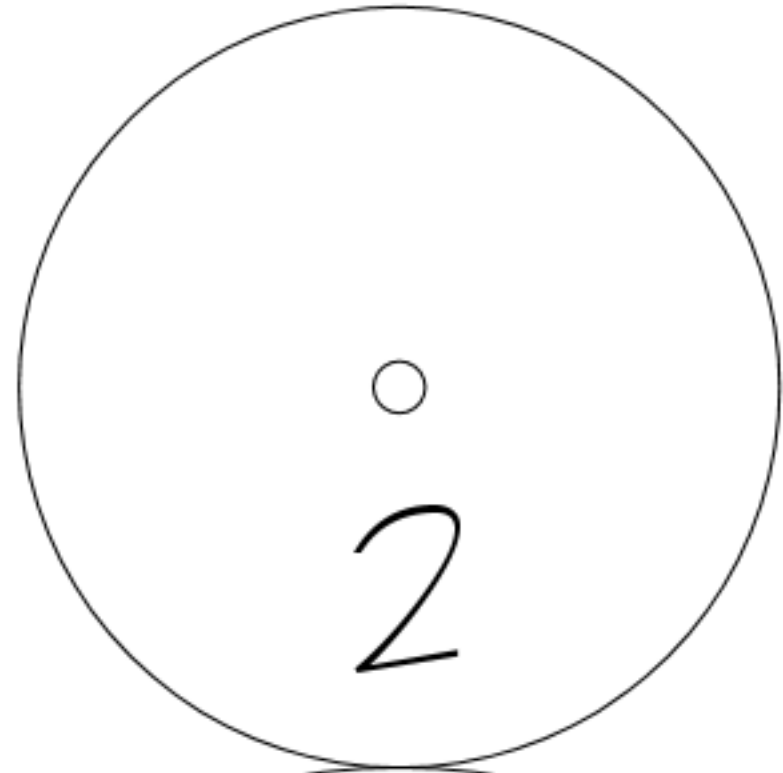

9

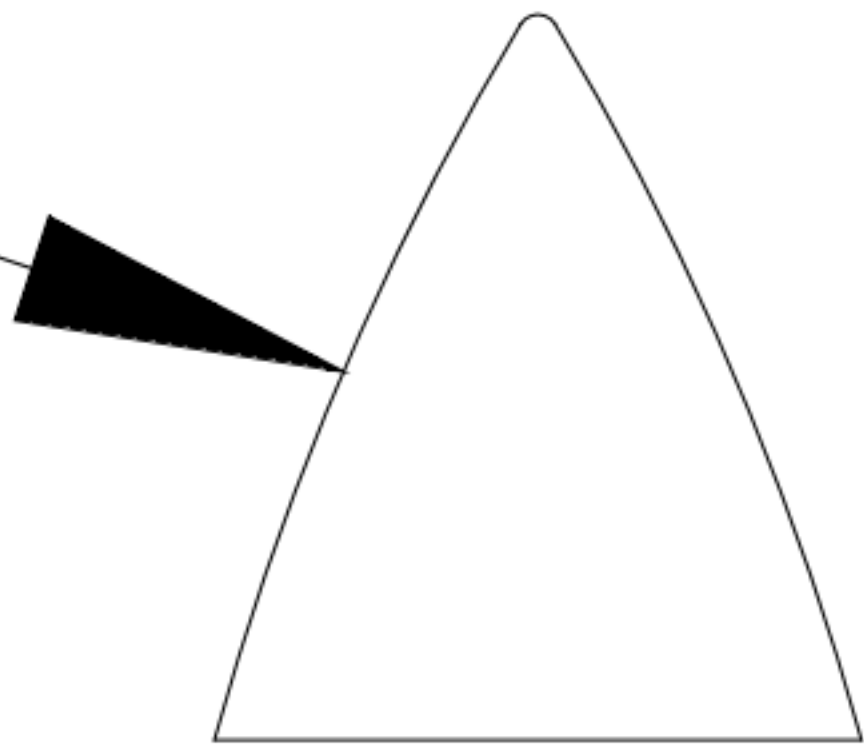

8

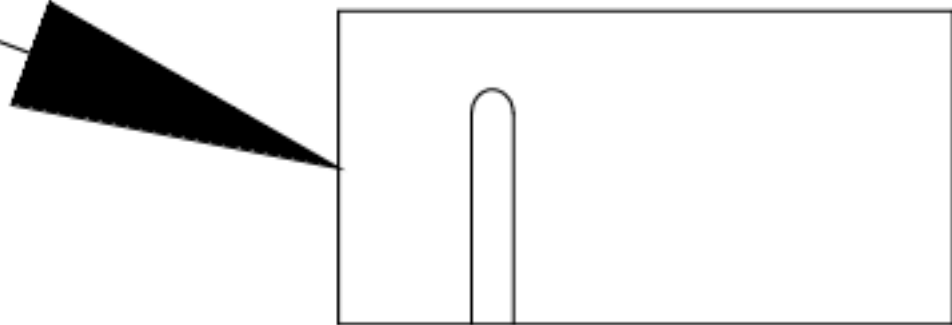

7

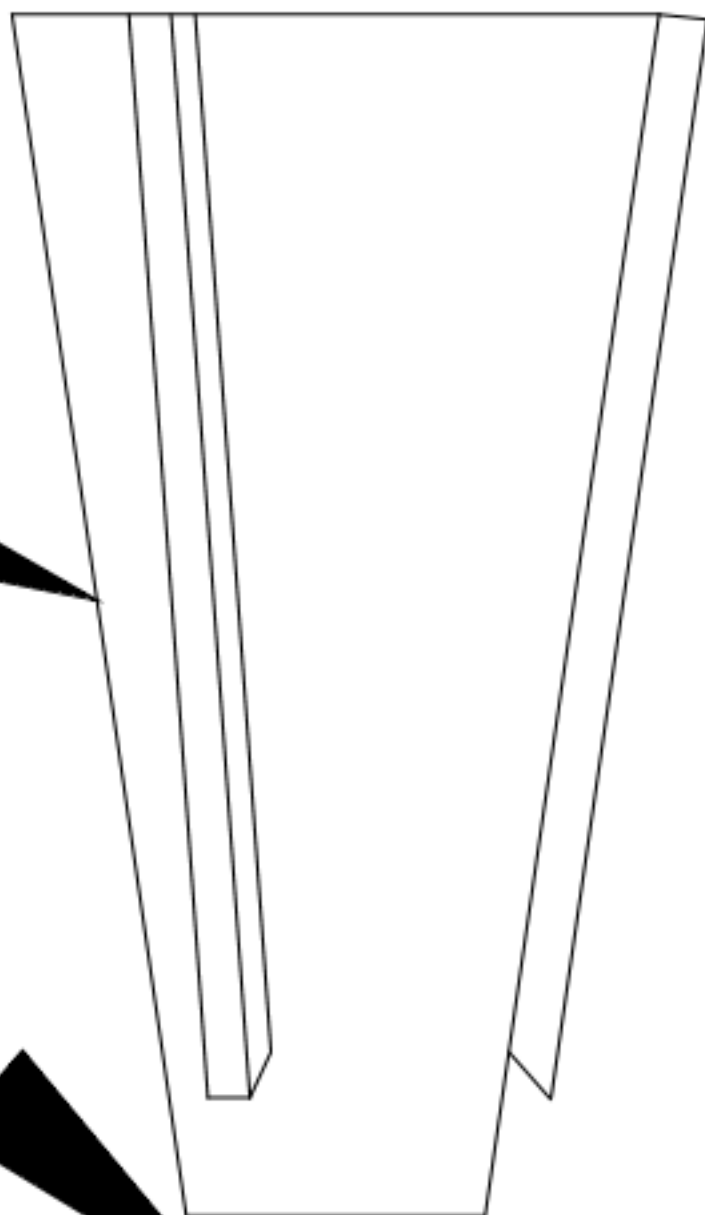

7a

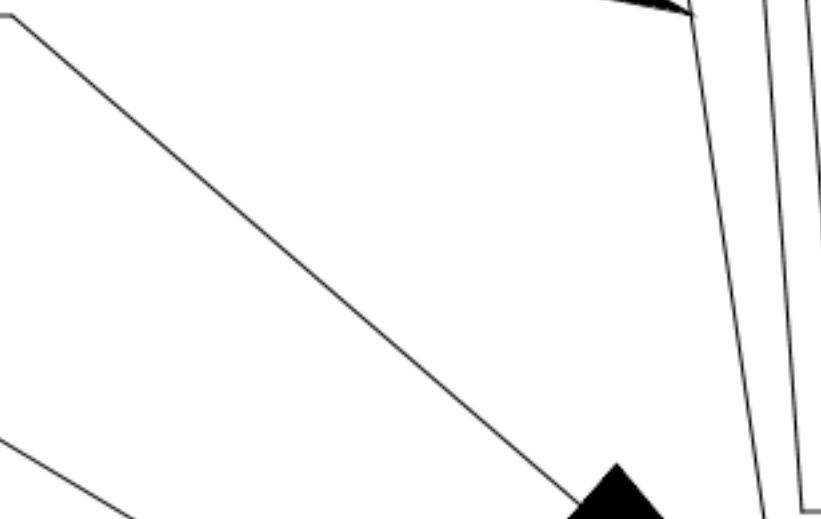

6

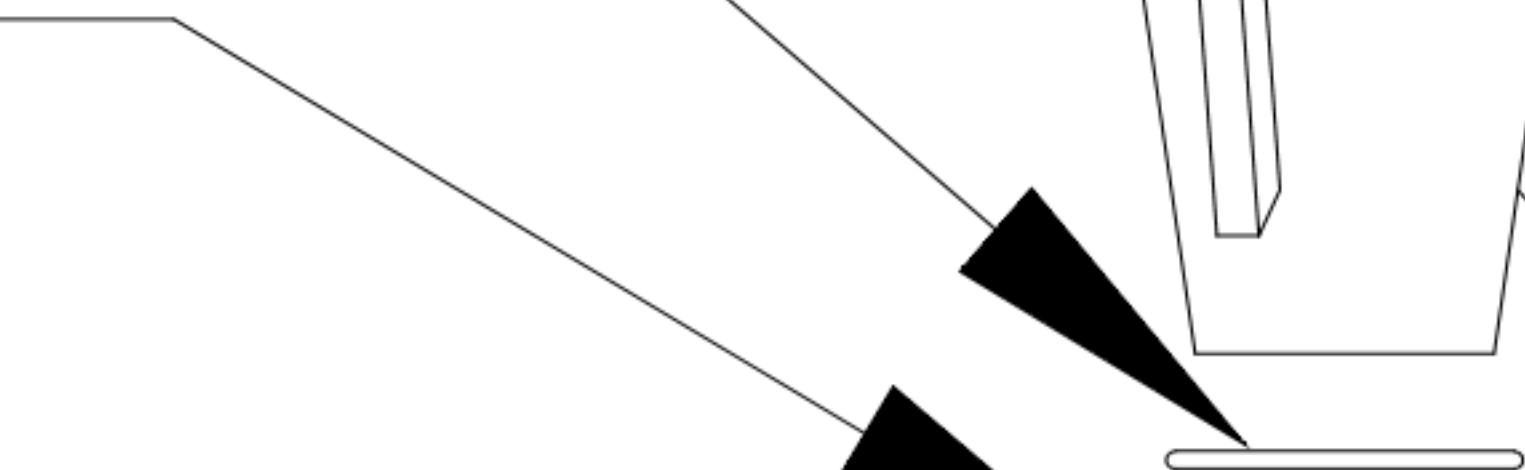

5

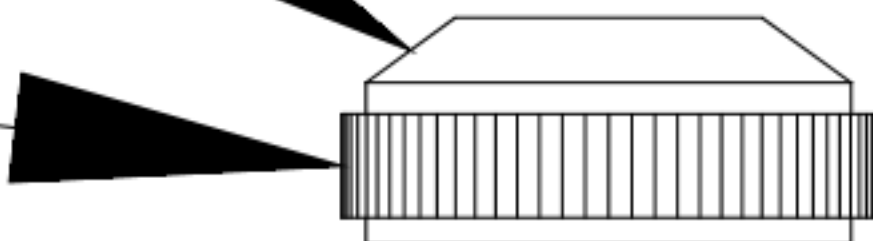

4



3

3b

3a

2

1c

1b

1a

1

1d

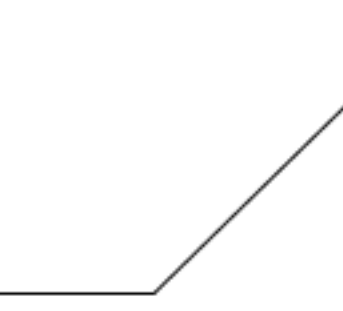
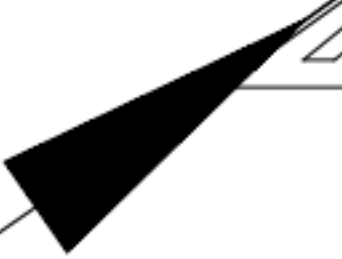
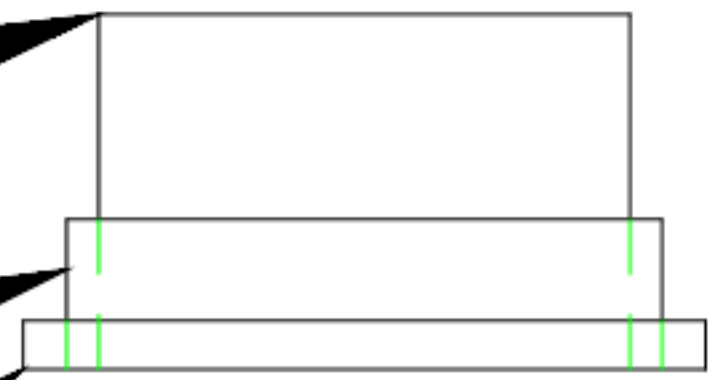
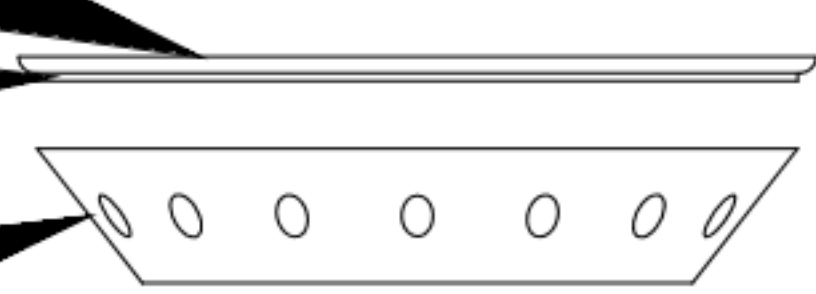
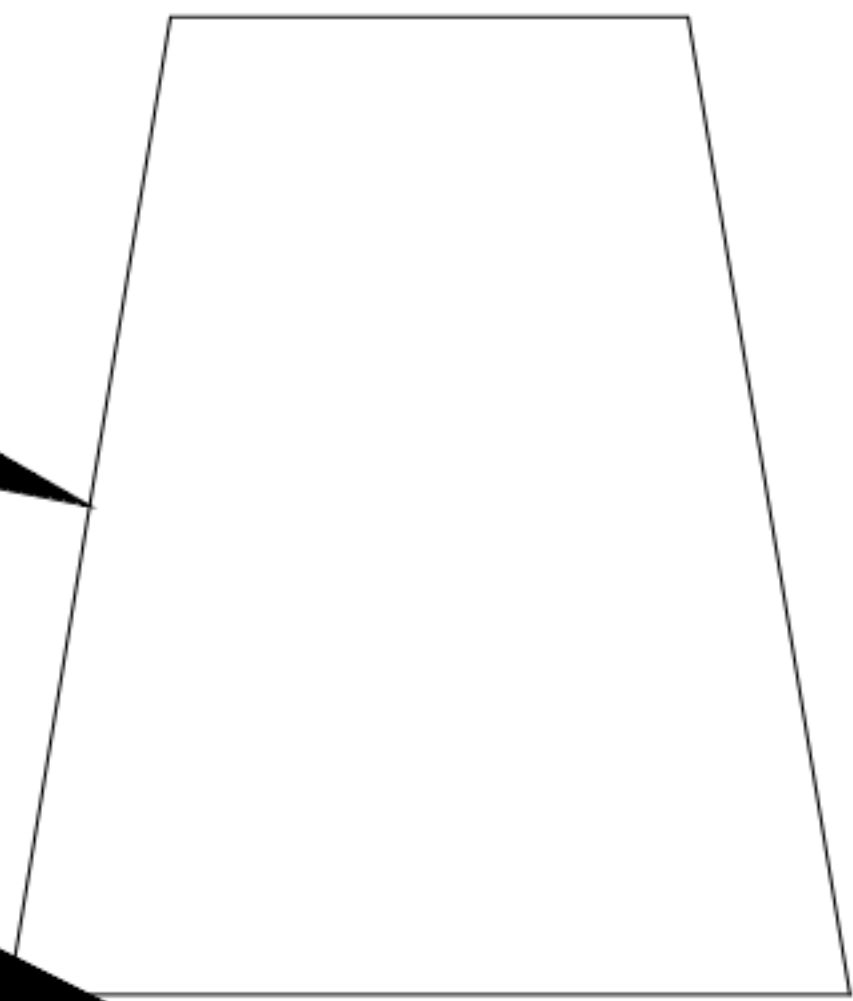

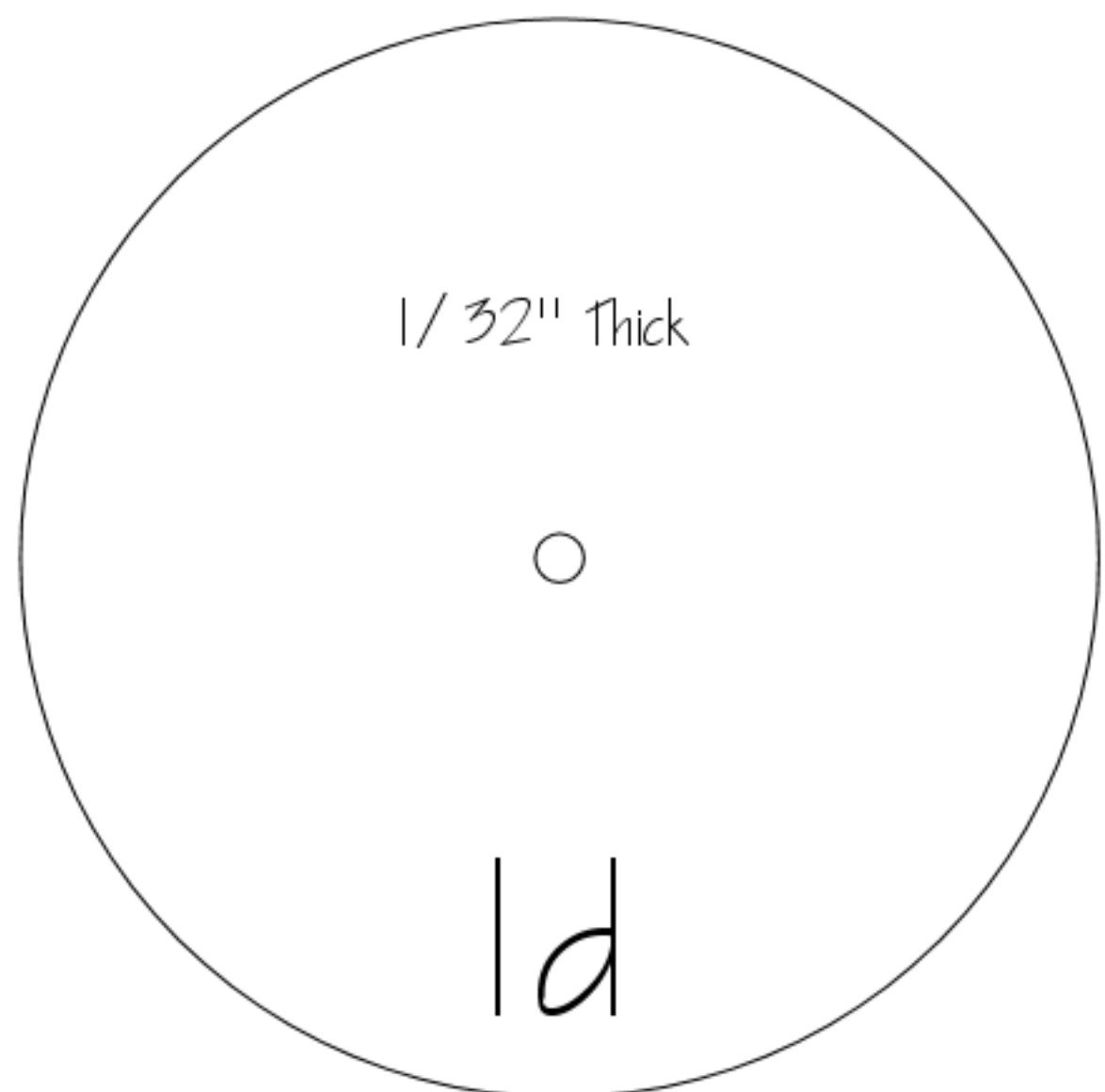
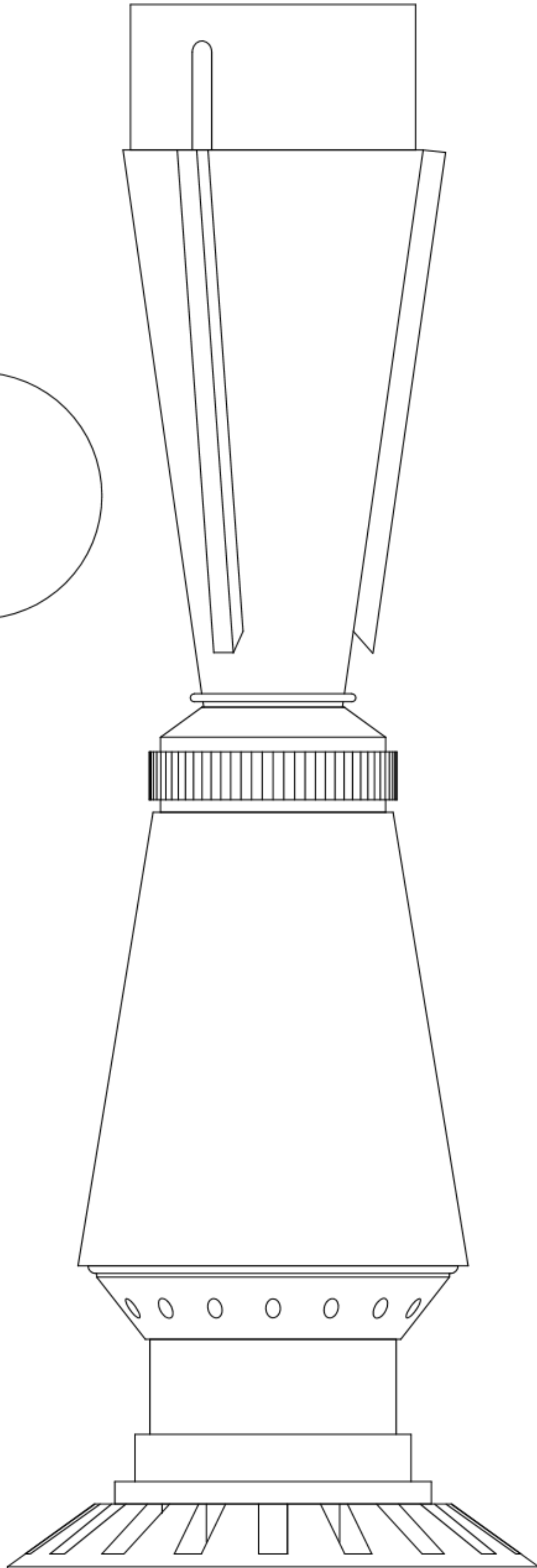
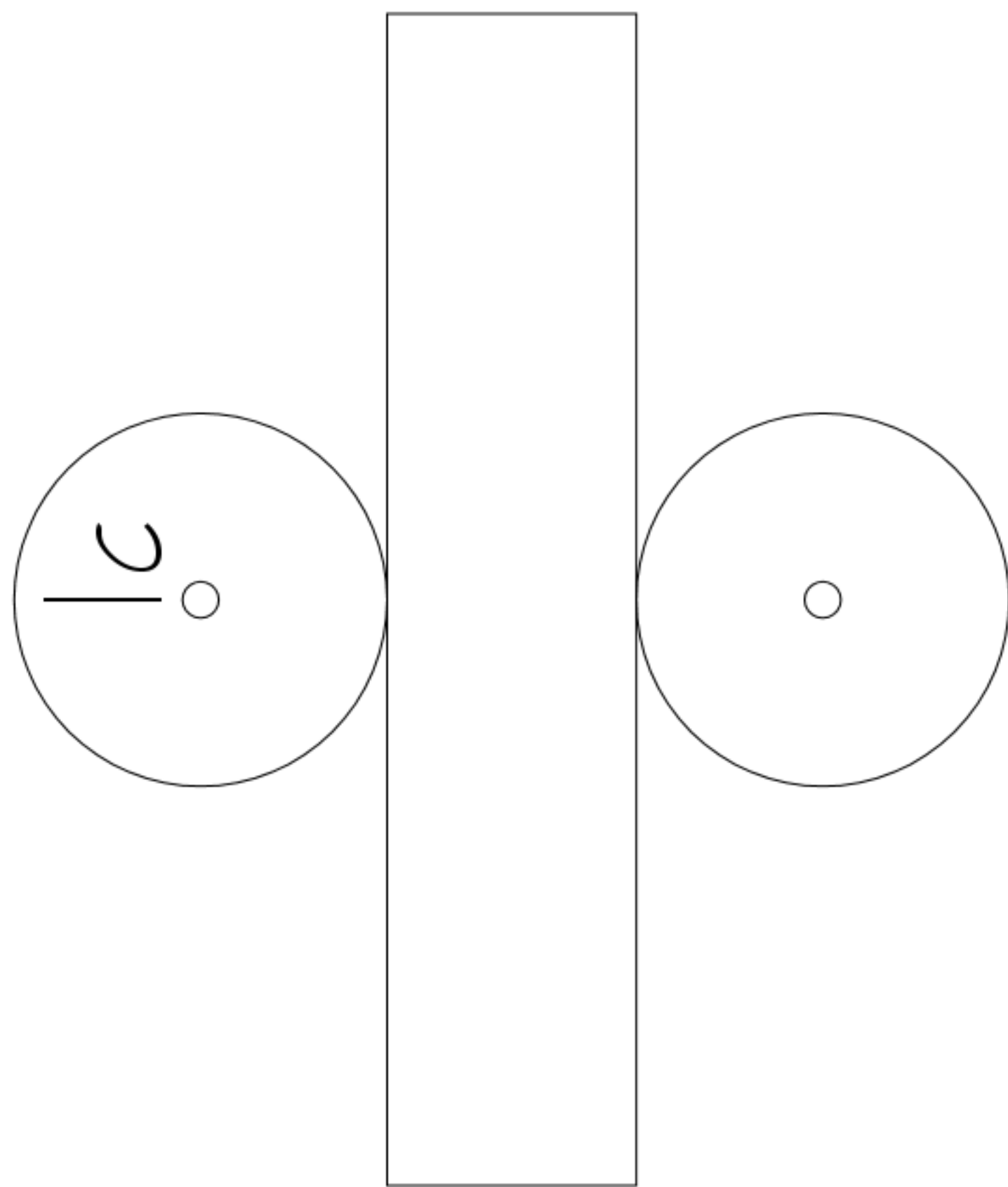

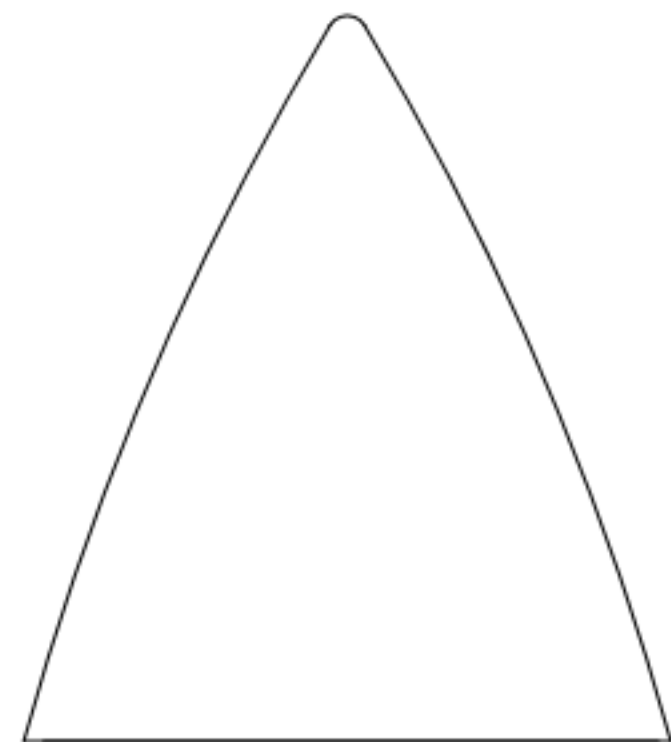
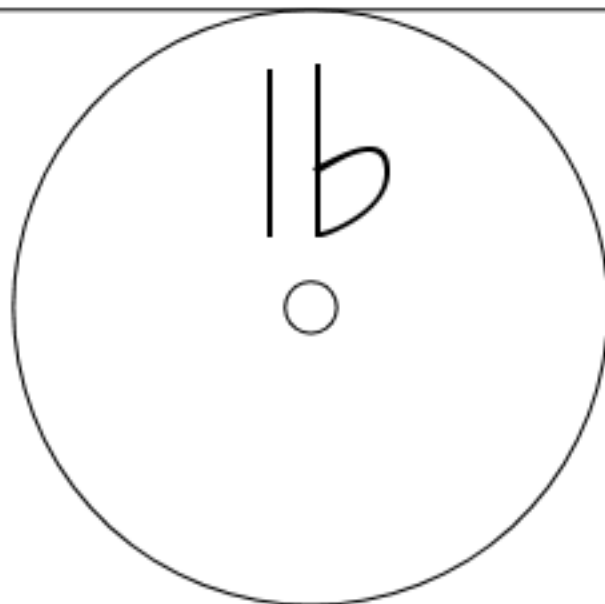
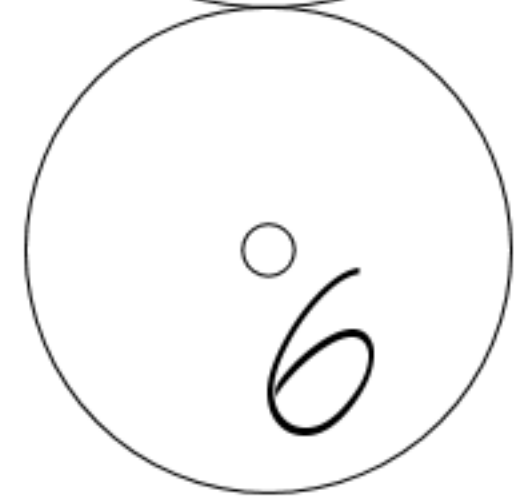
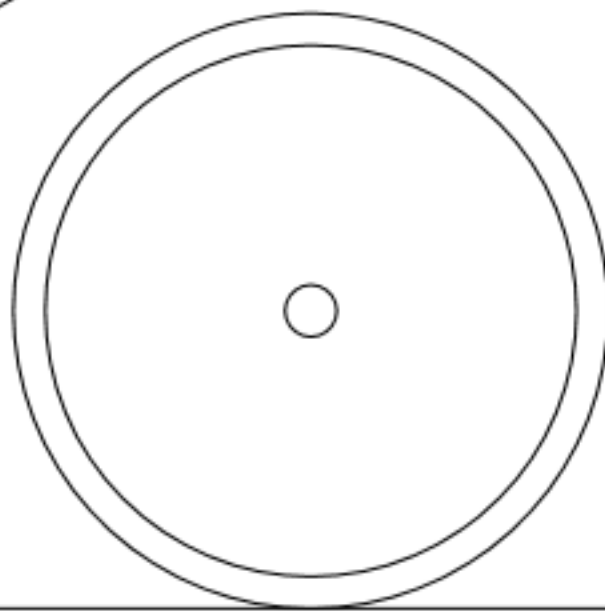
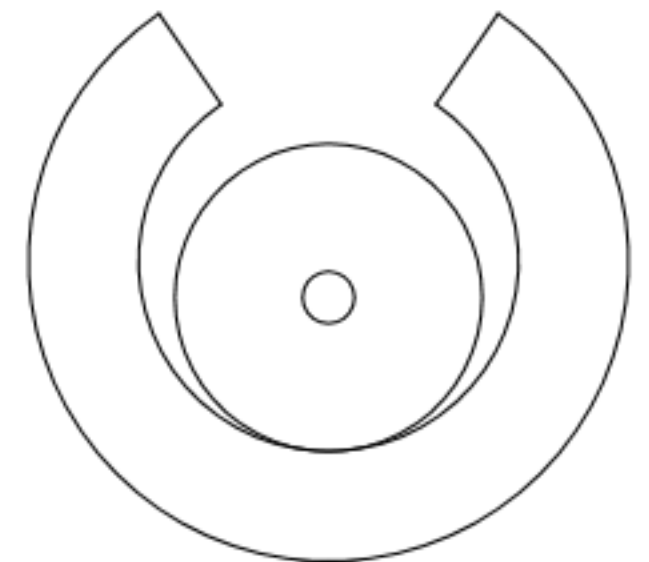
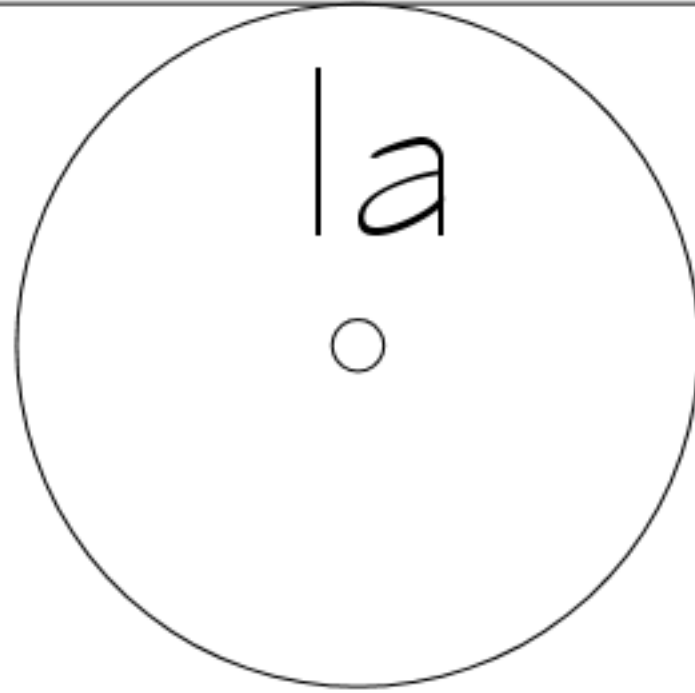
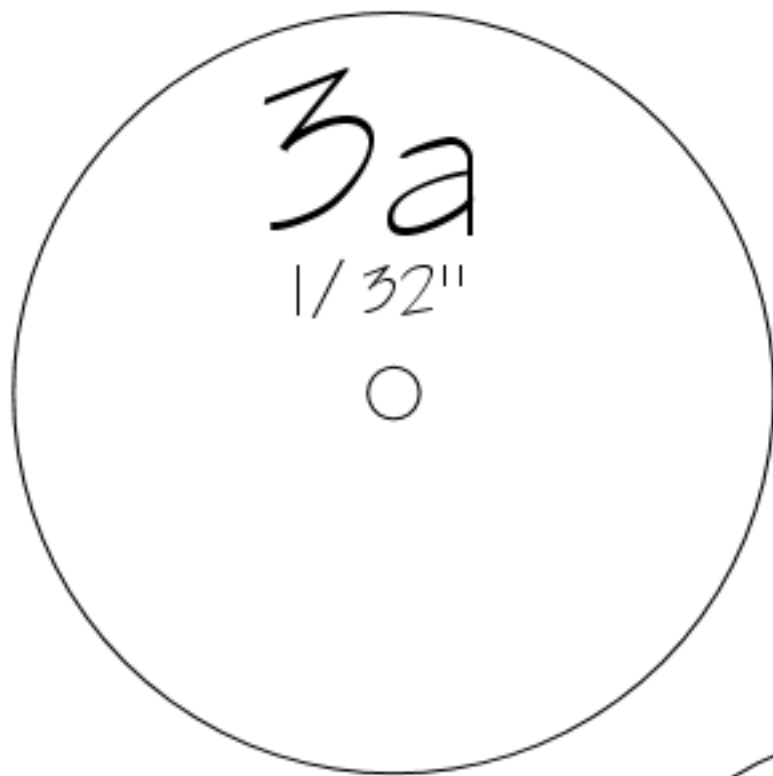
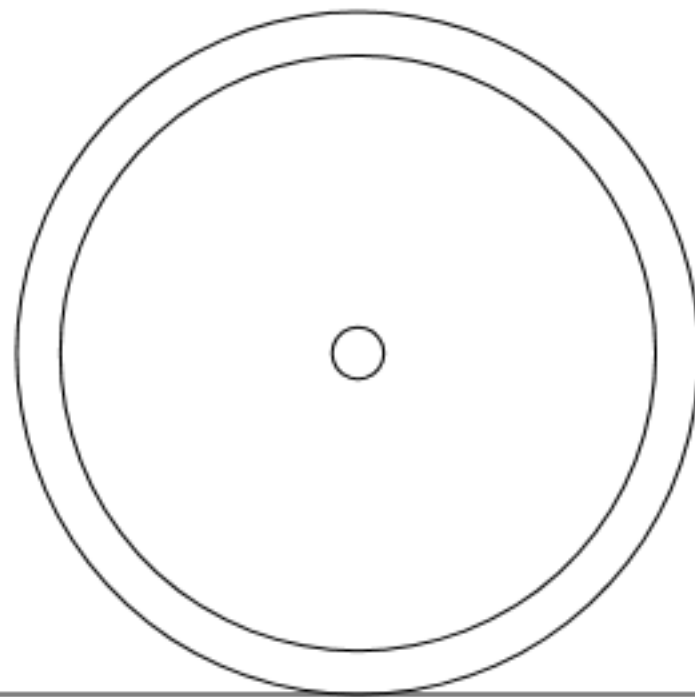

Centimeters

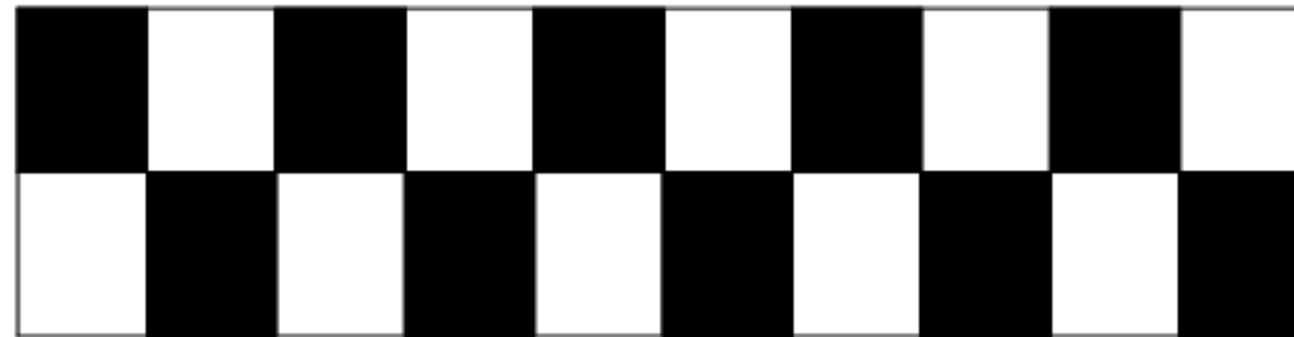

Inches

Copyright 2005 Alan Sinclair

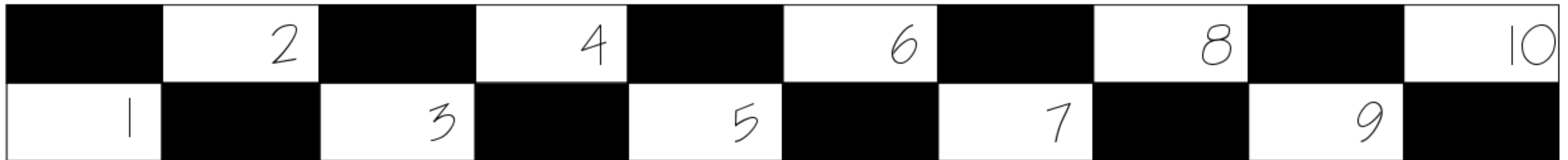

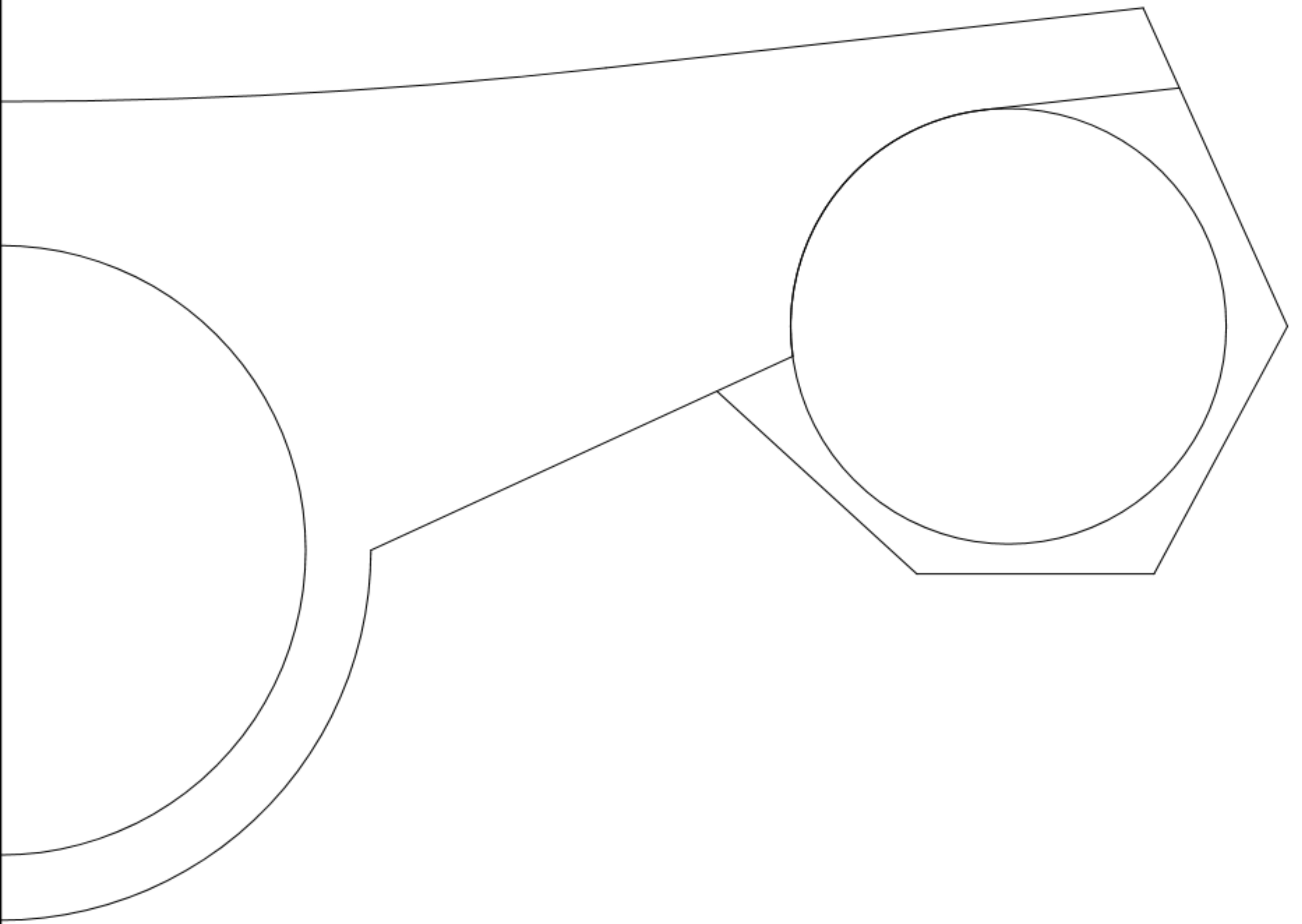

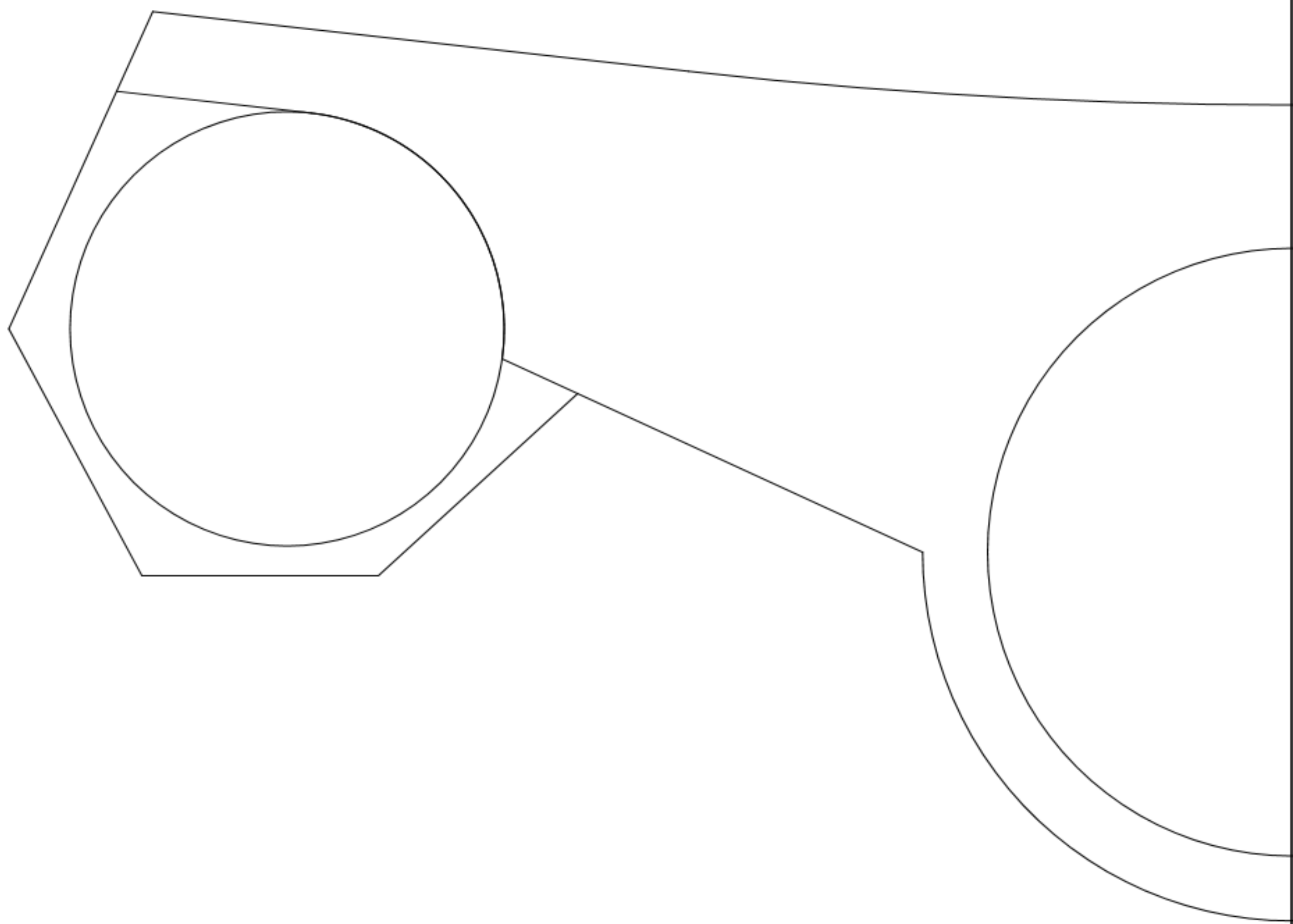



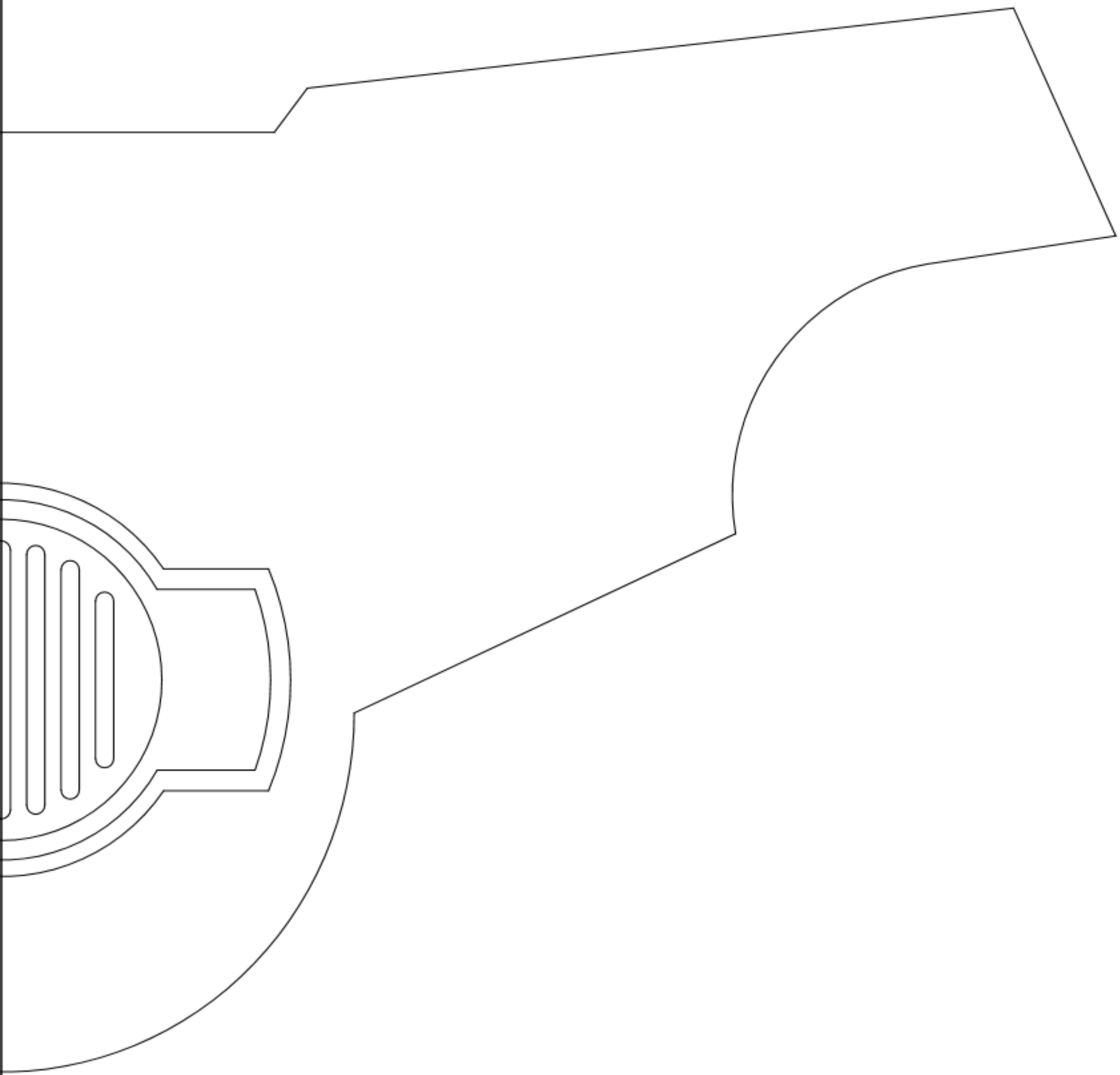

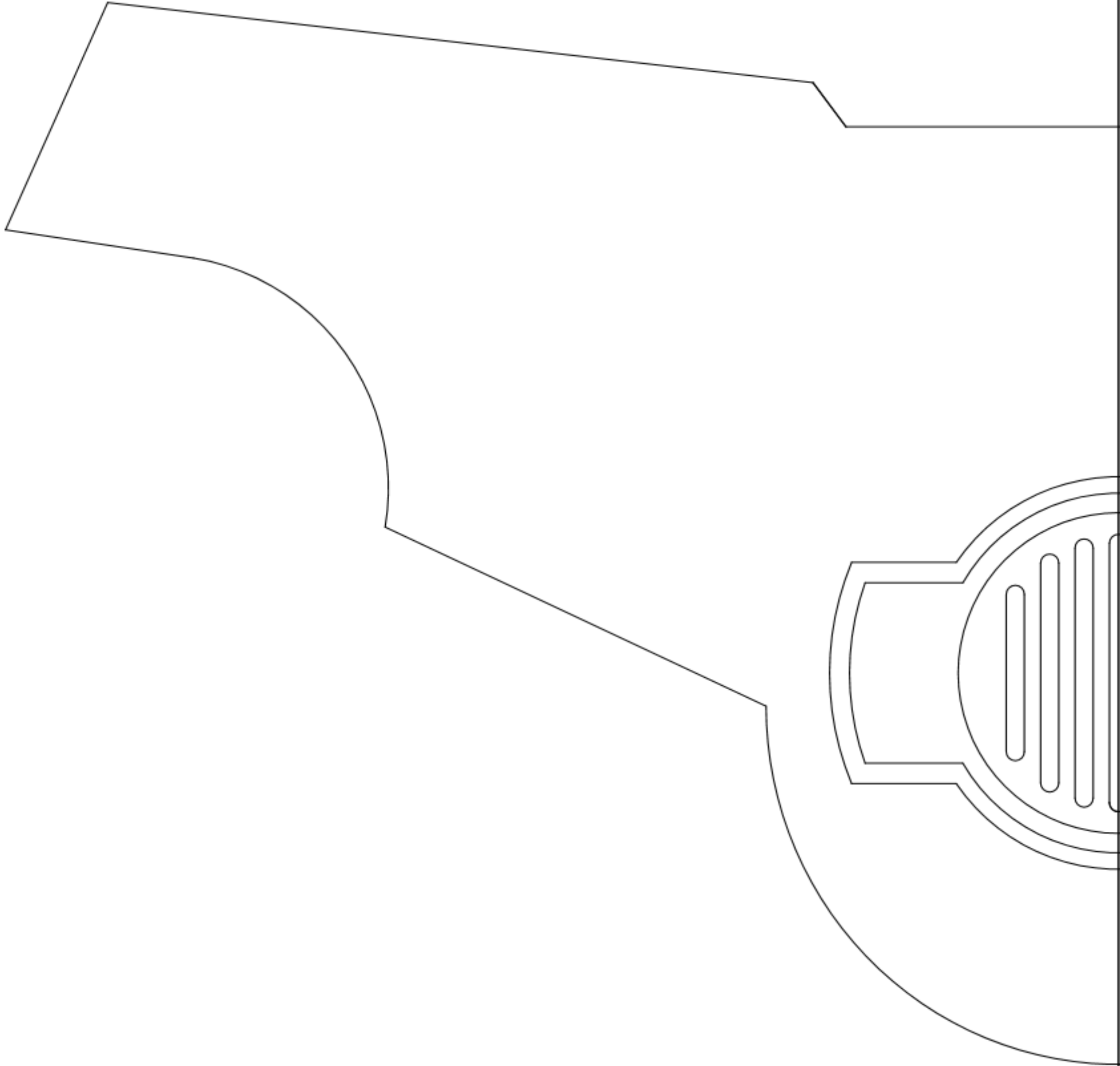

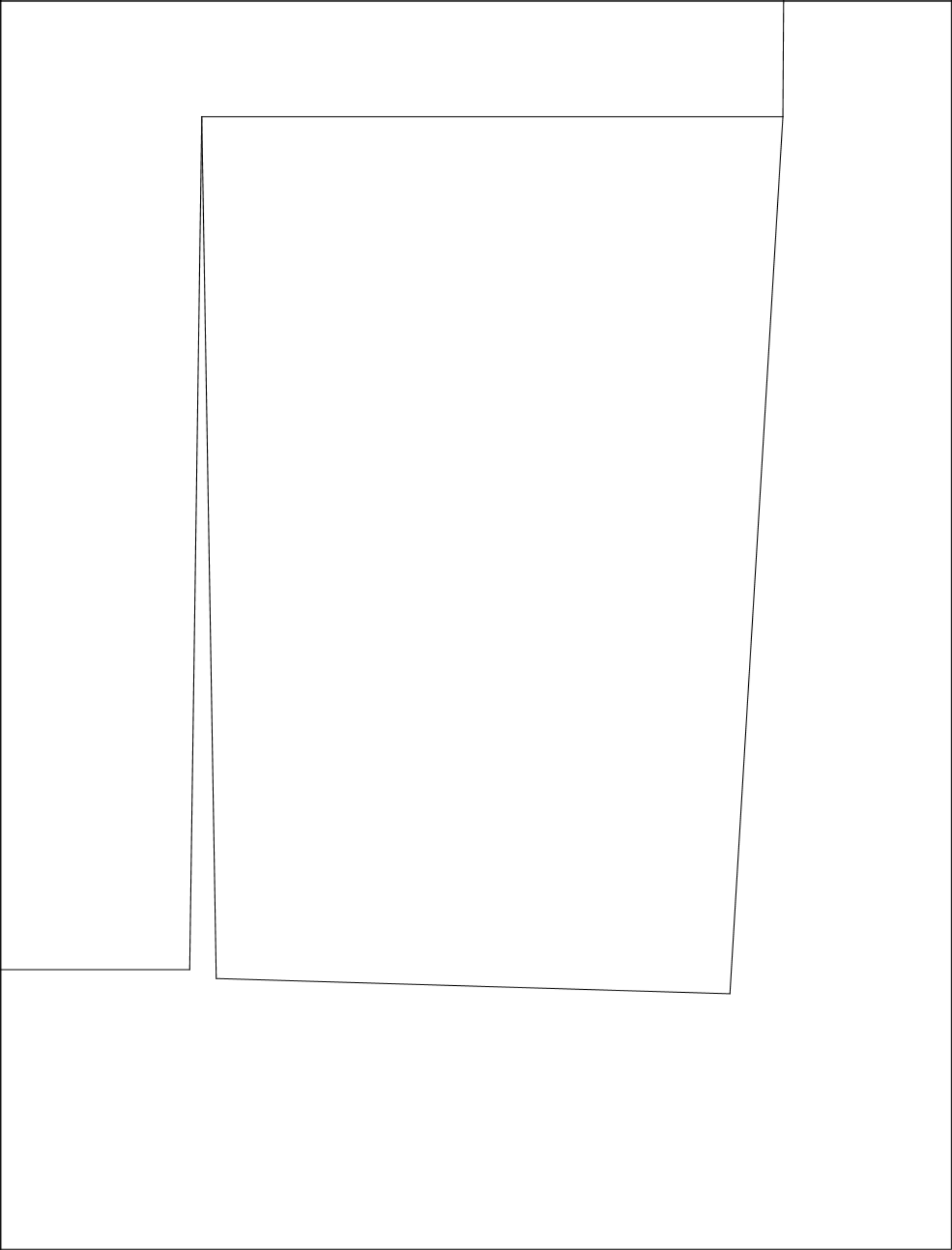

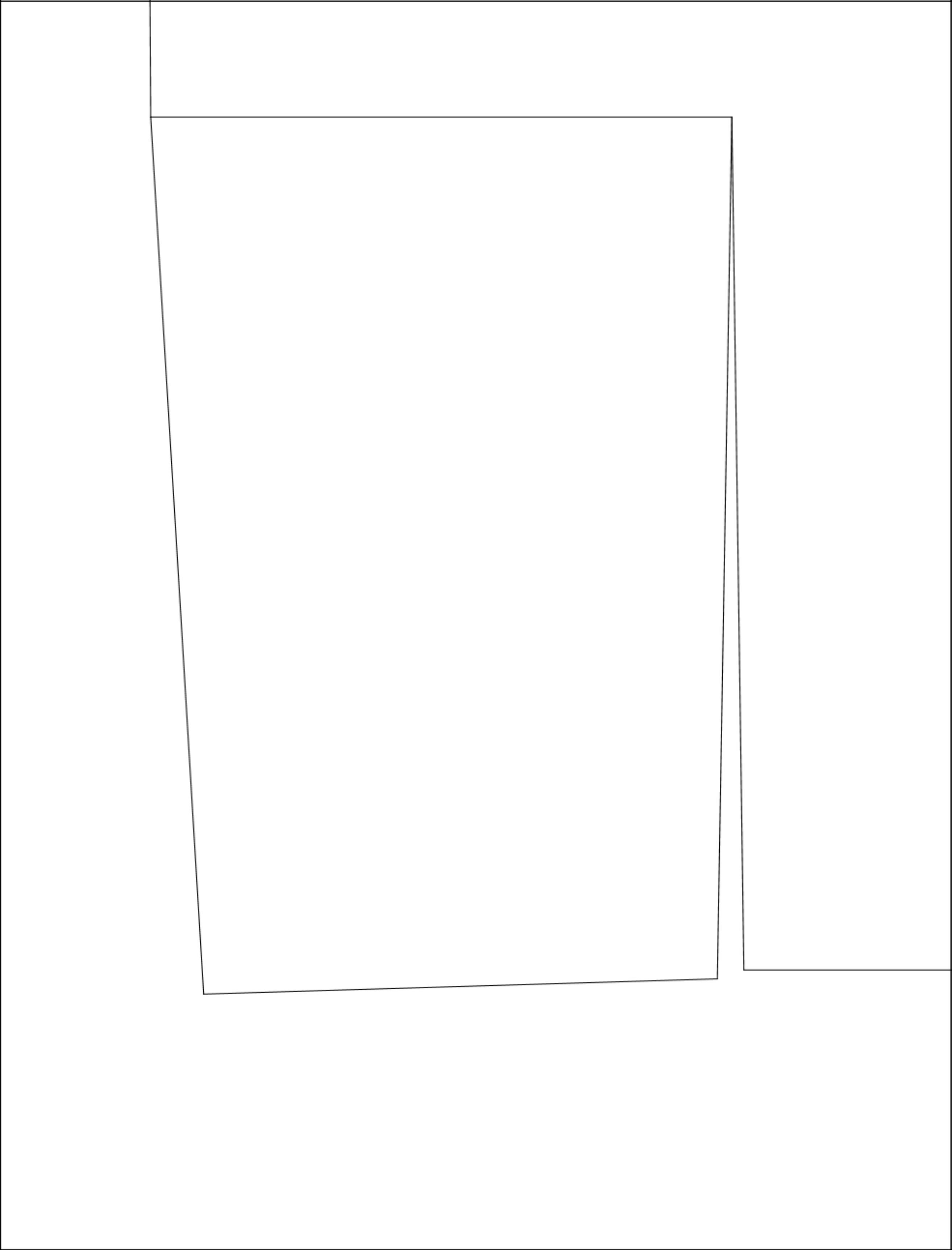

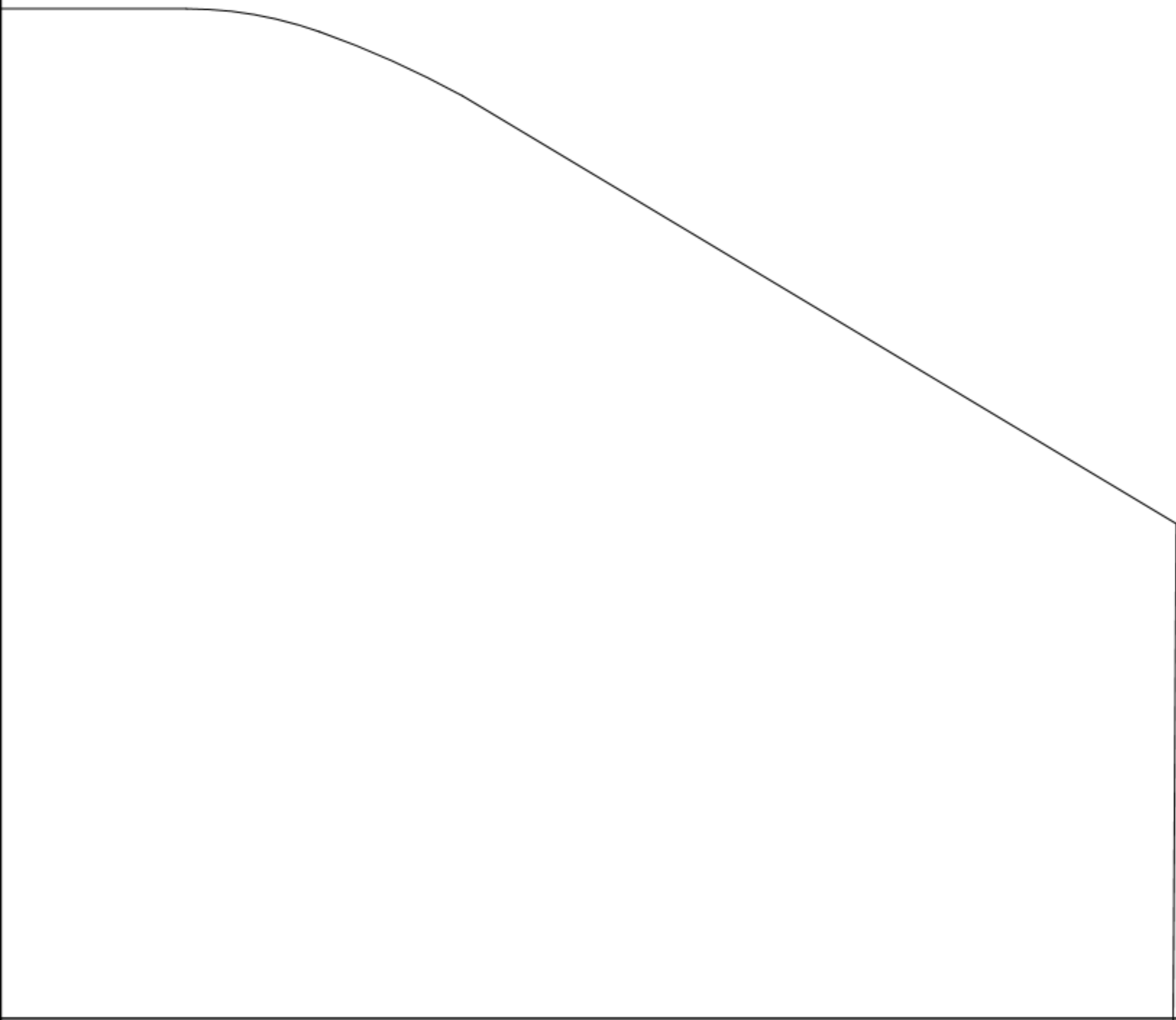

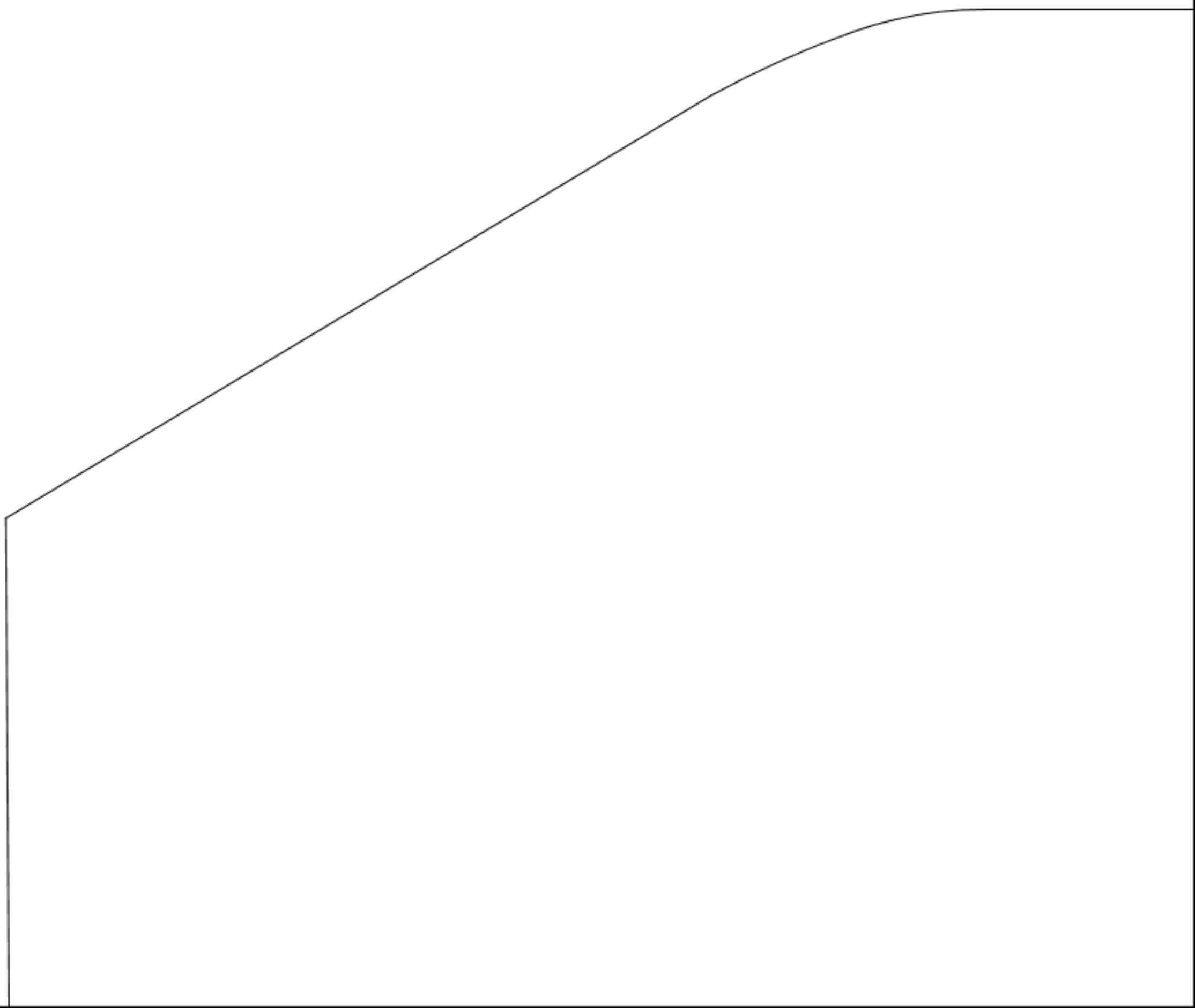

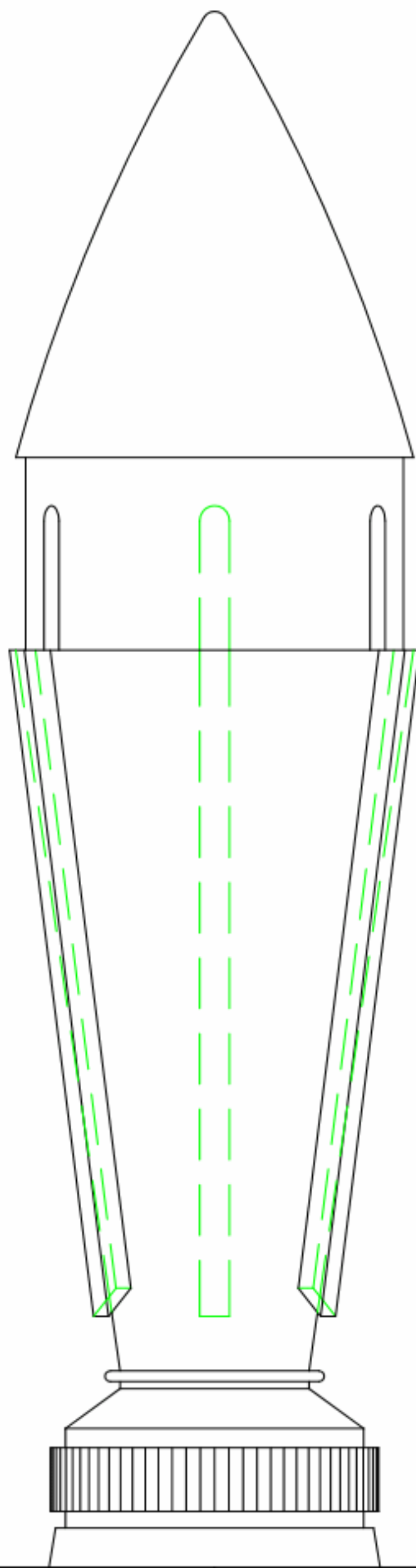

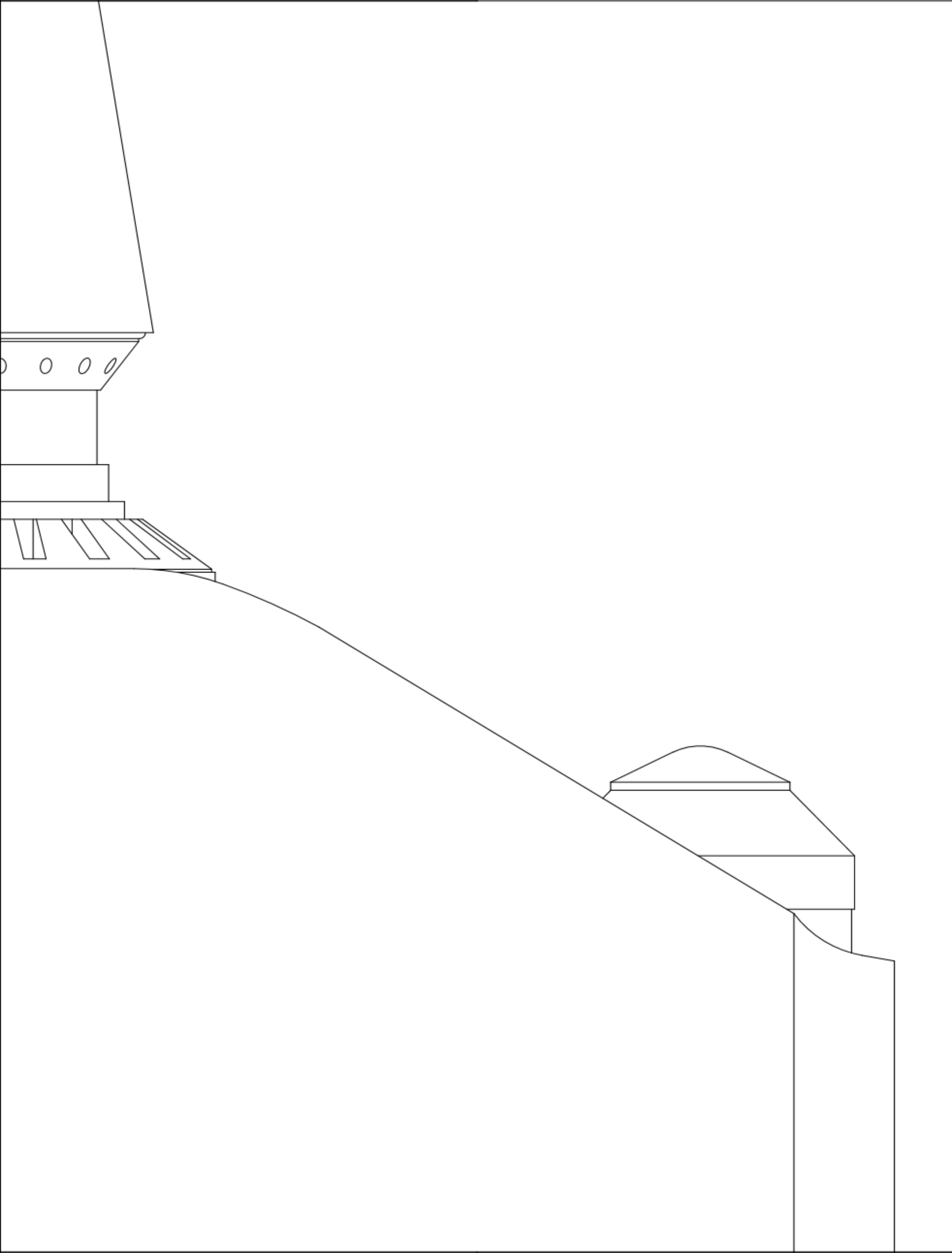



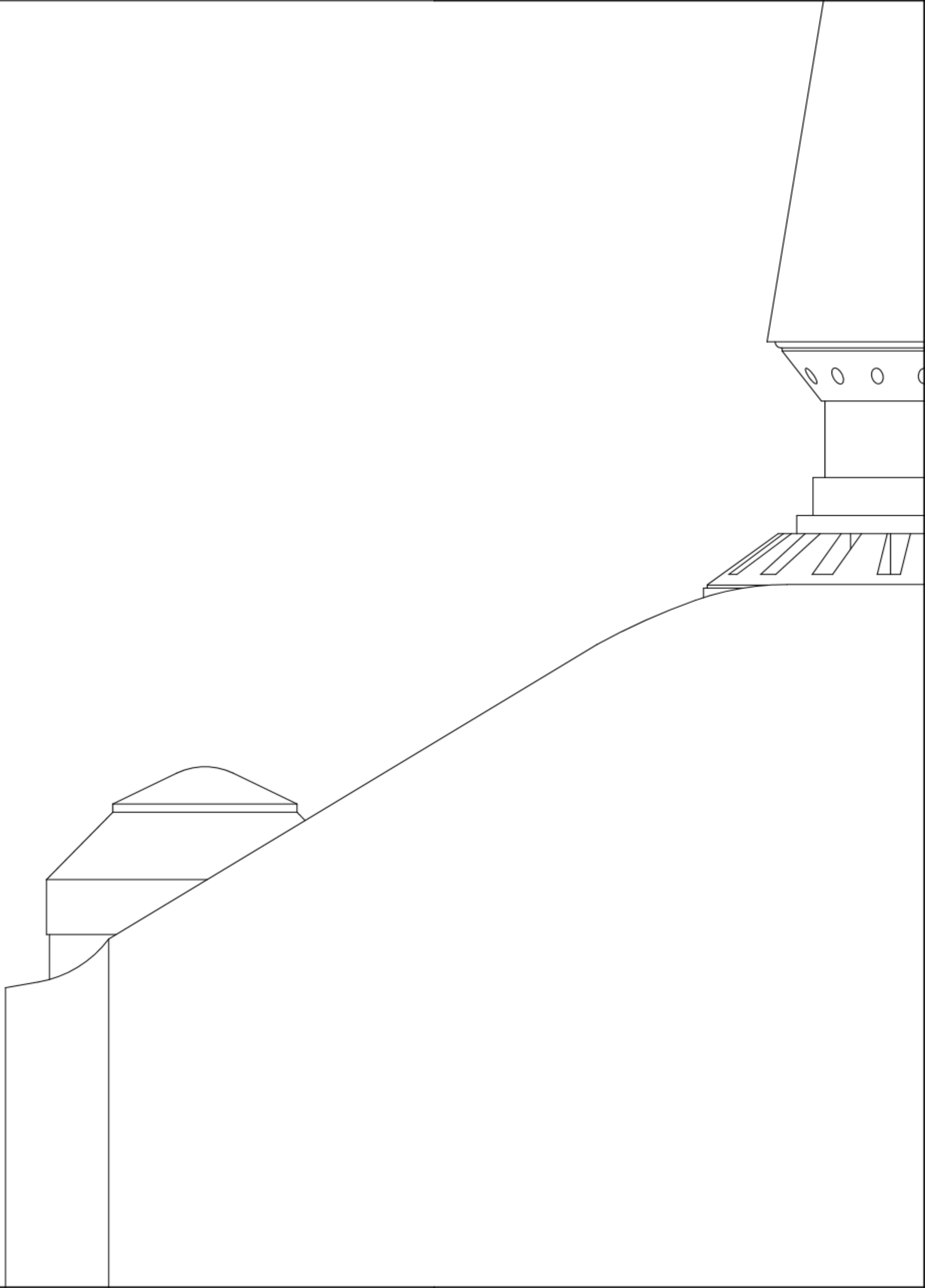

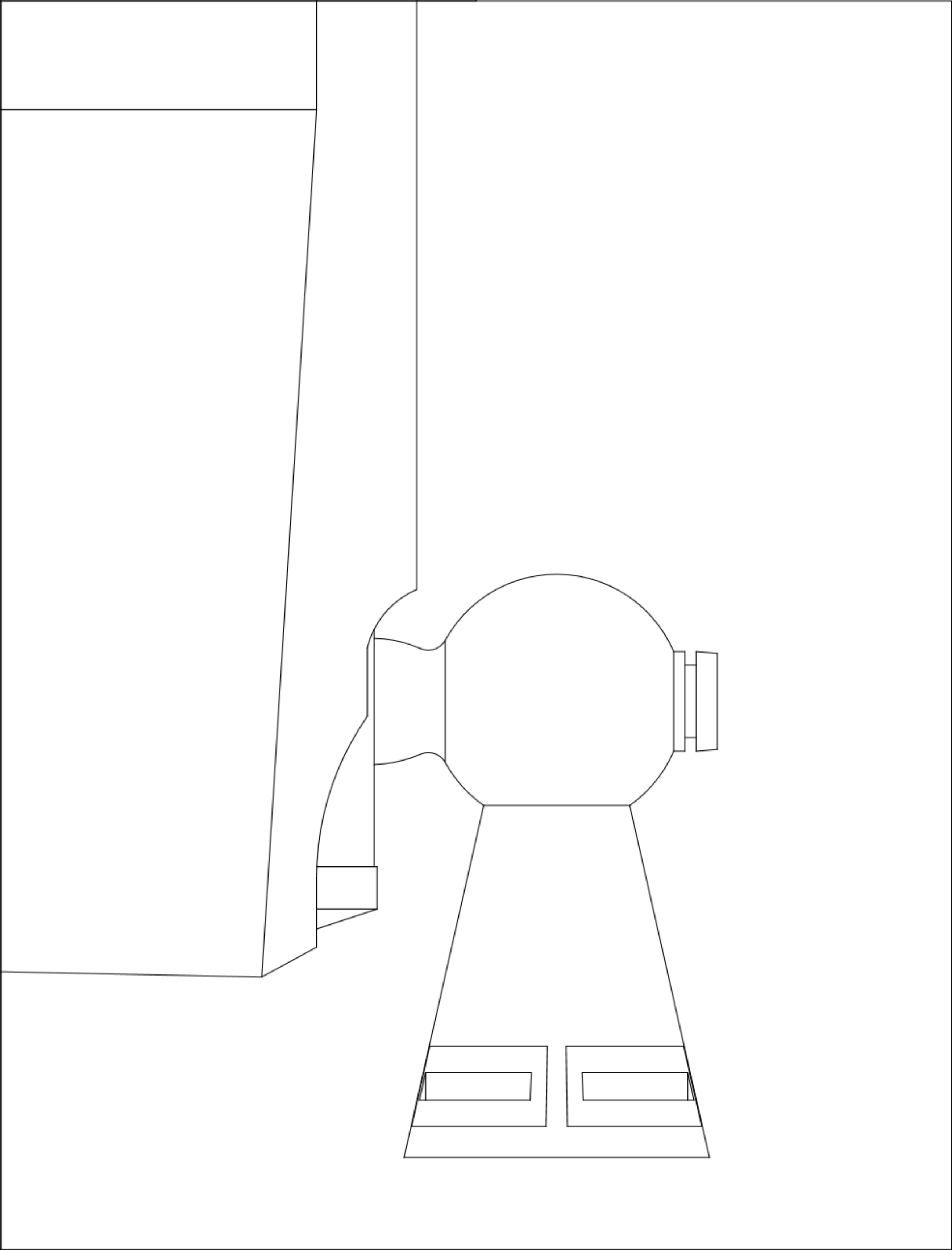

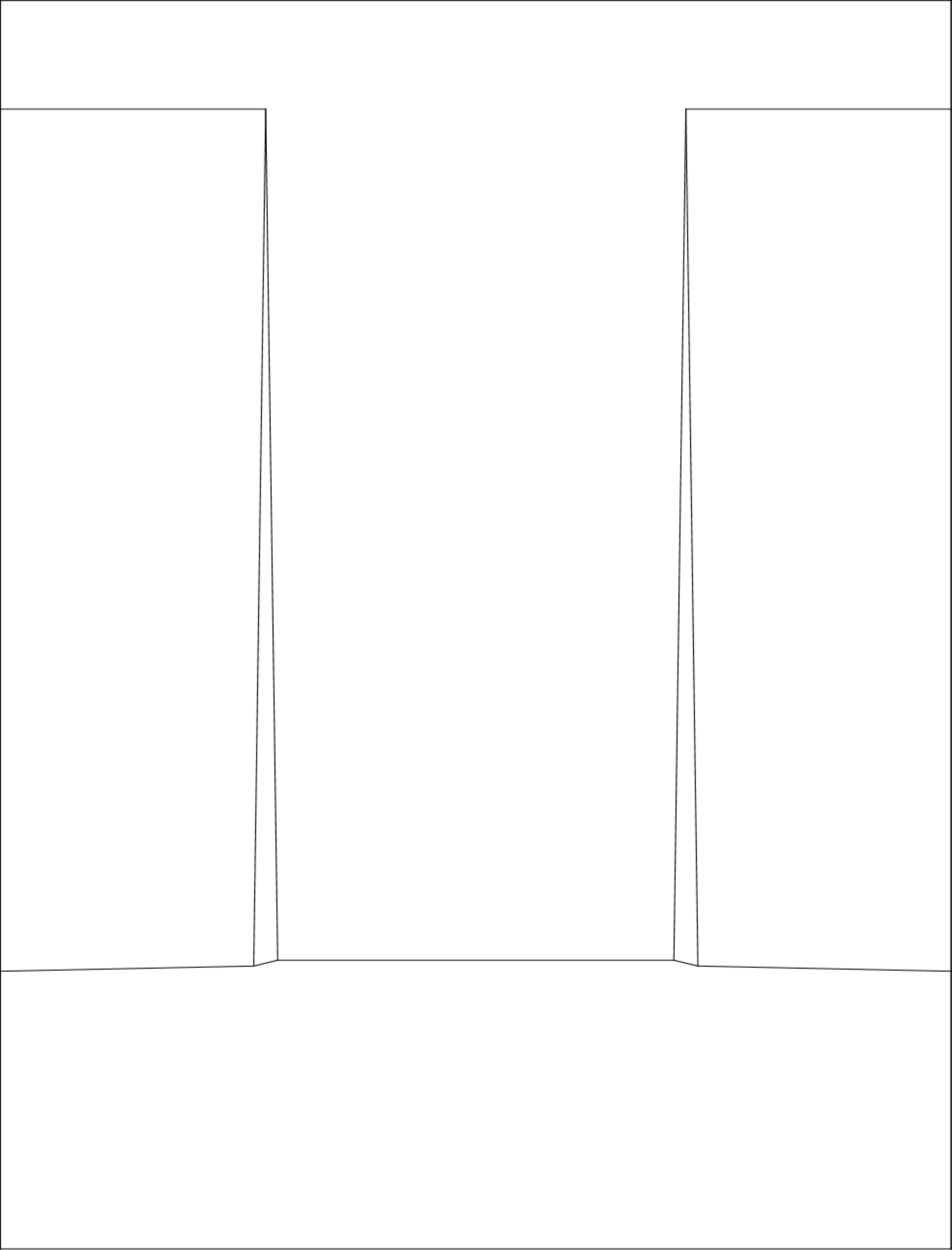

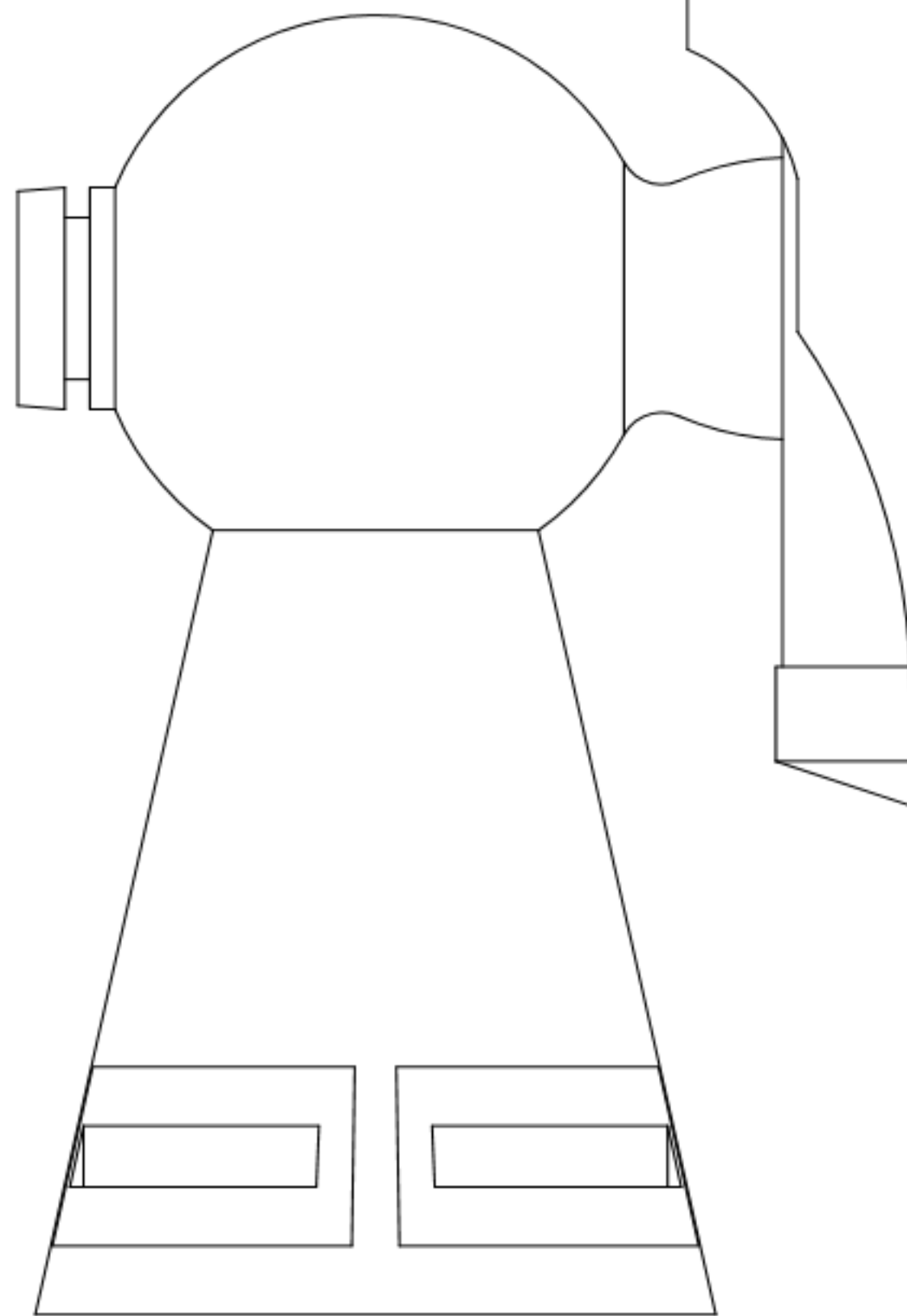

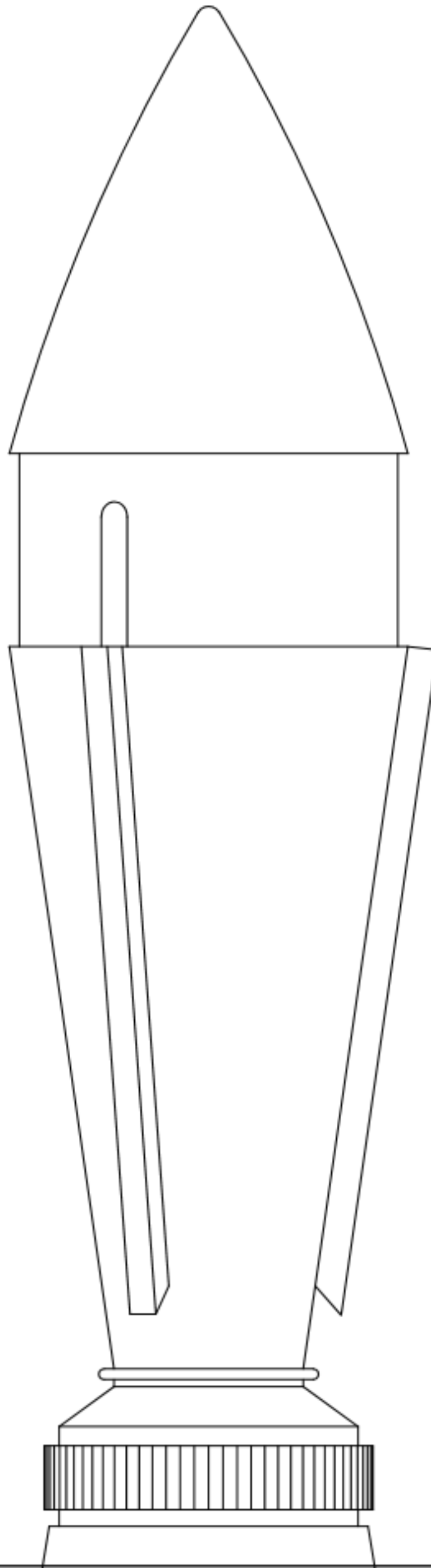
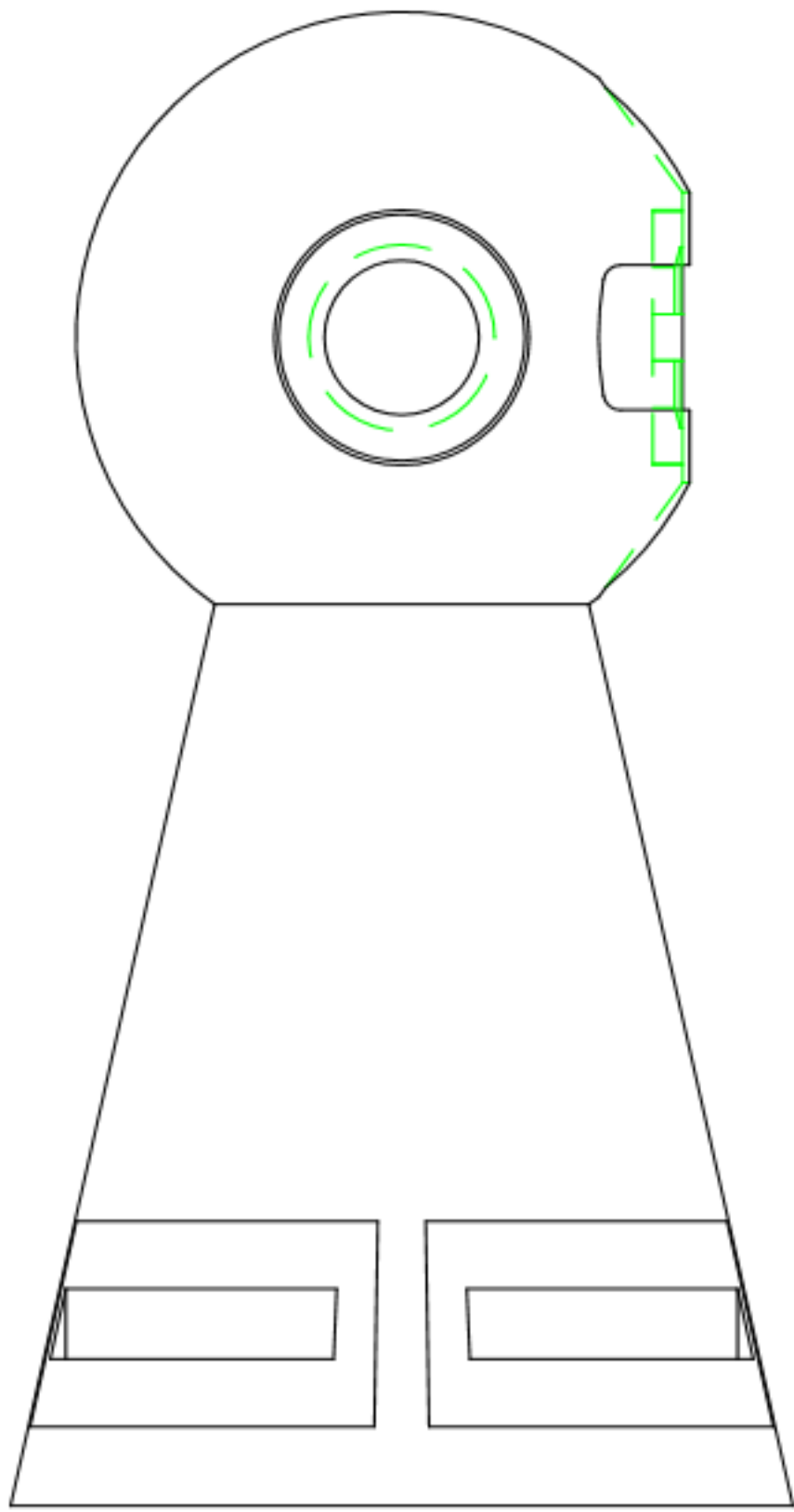

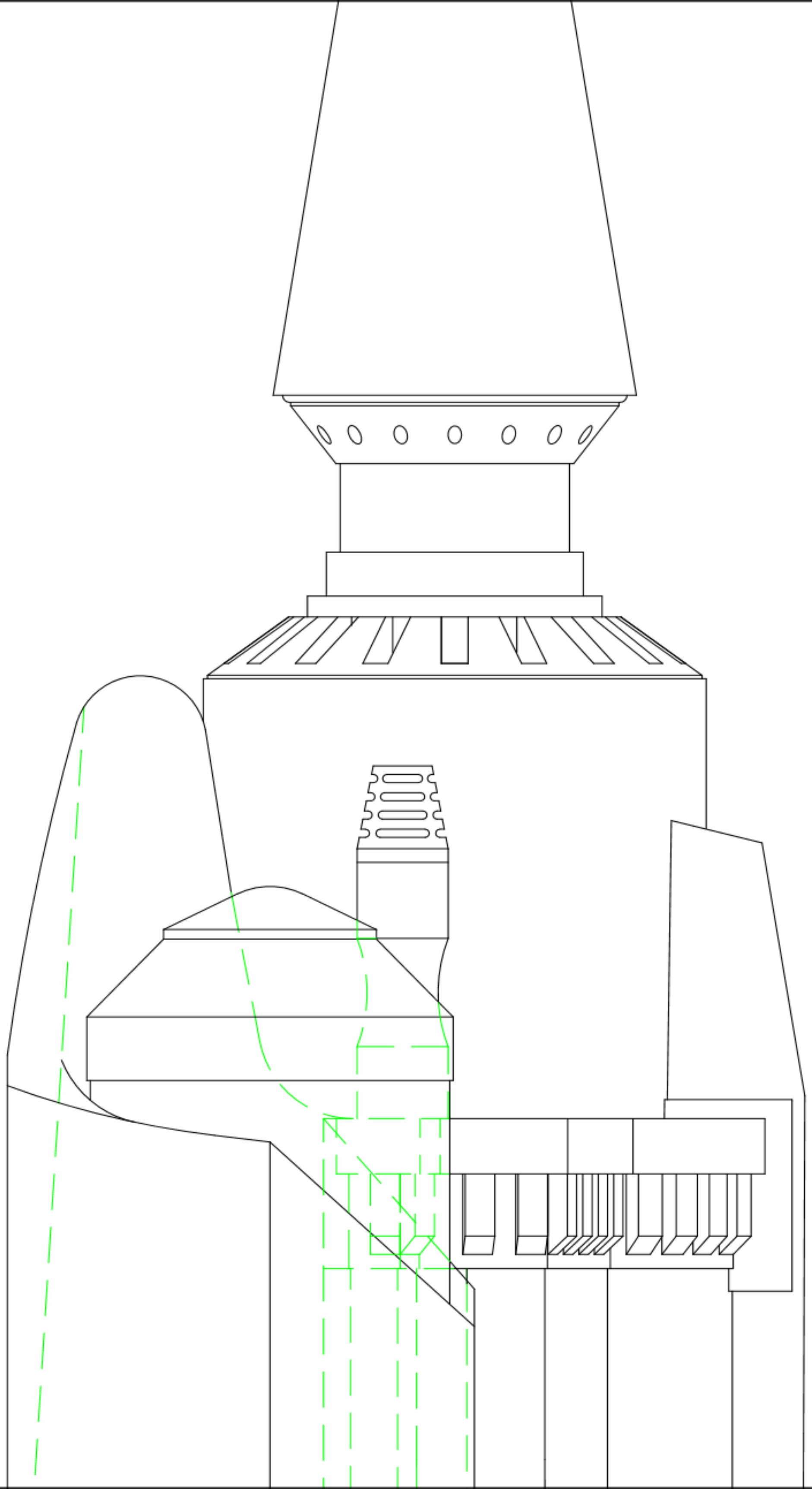

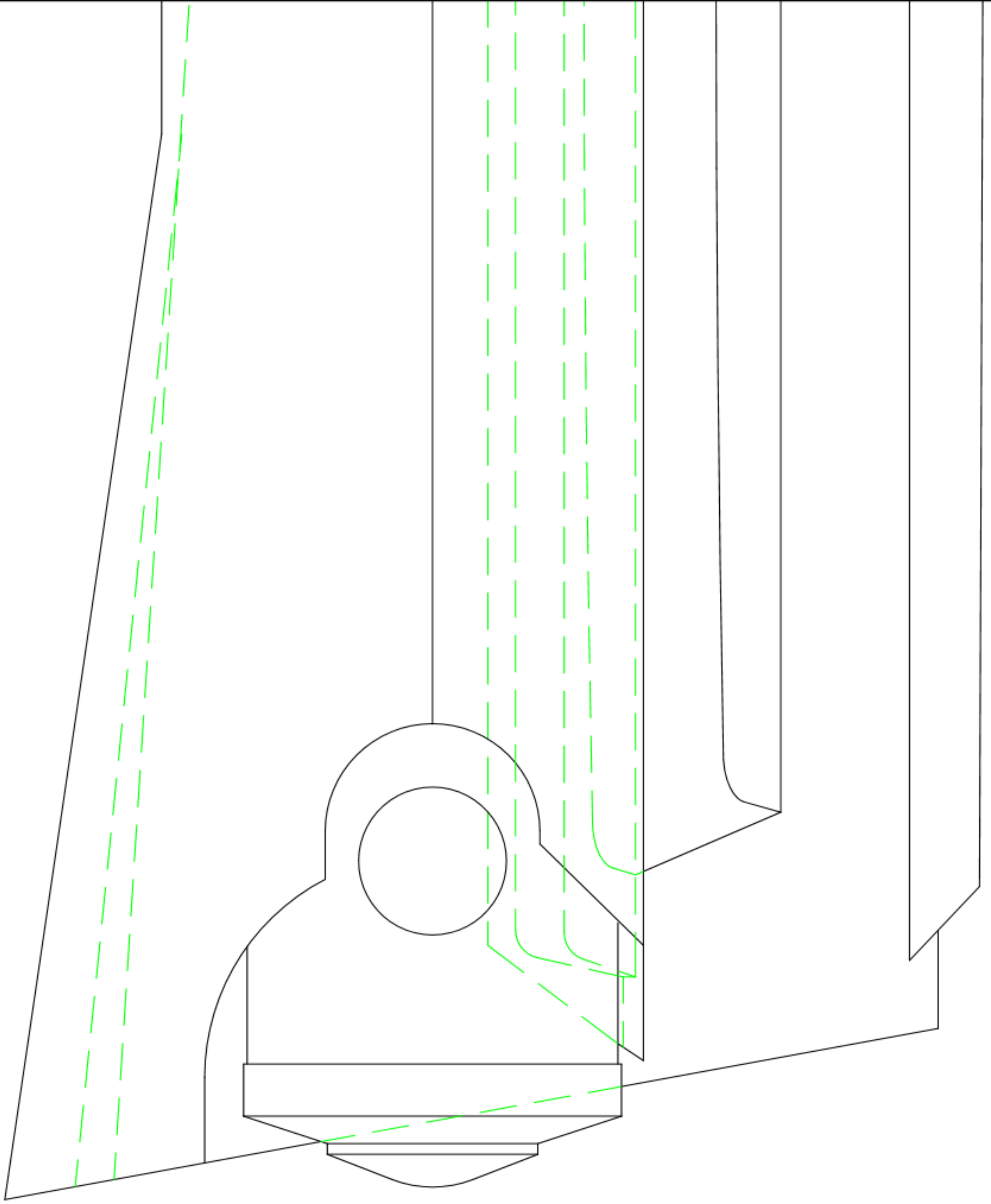

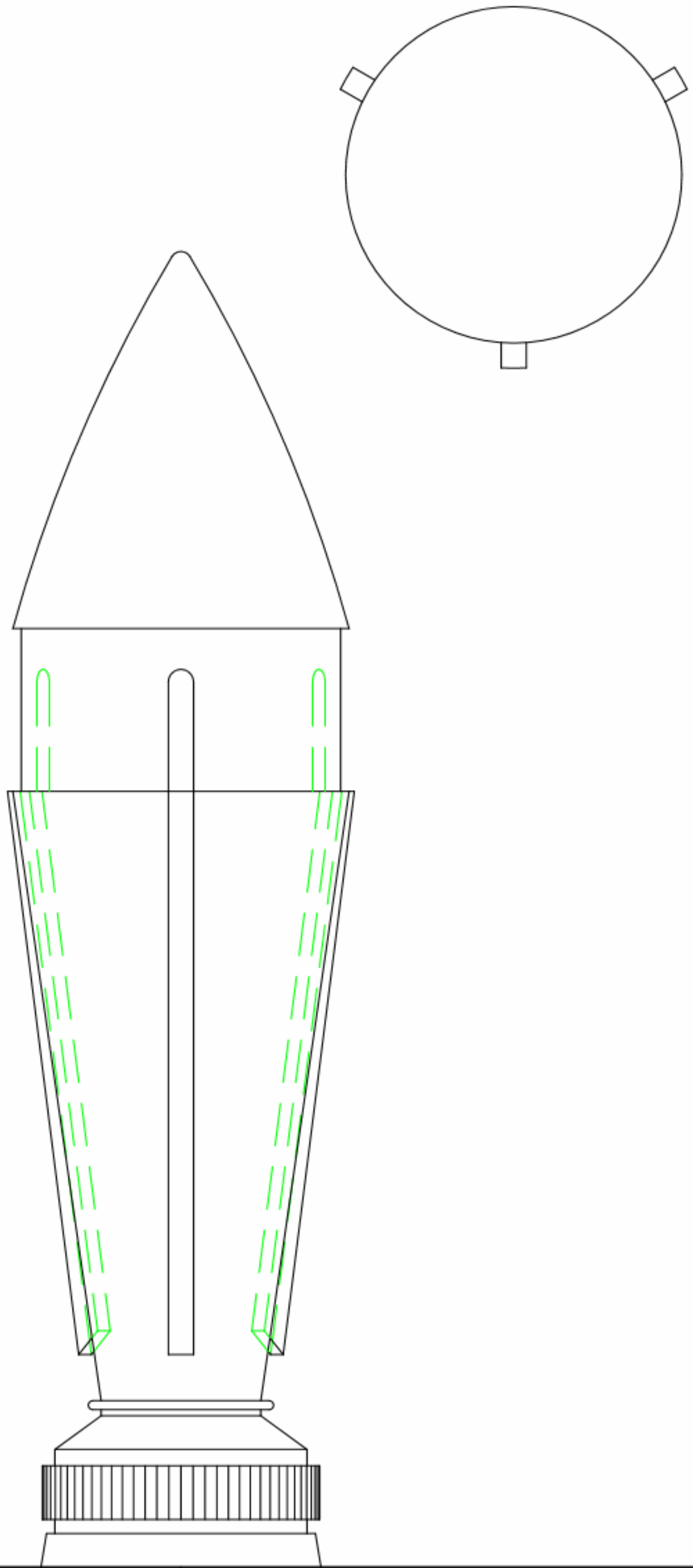



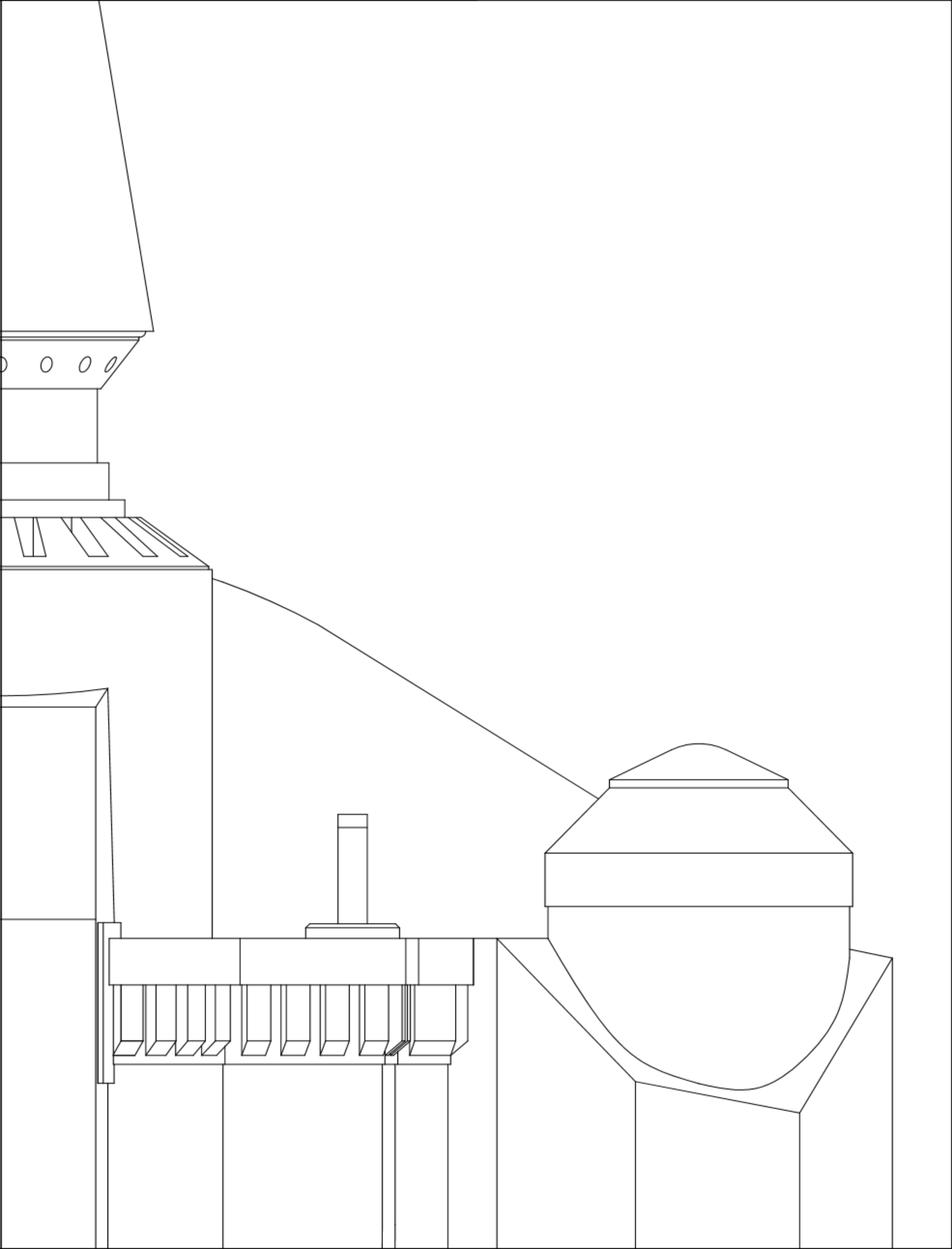

Alternate designs from  
the Art of Star Wars

