

(BBAC)
breadboard arduino
compatible

Breadboard Arduino Compatible Assembly Guide

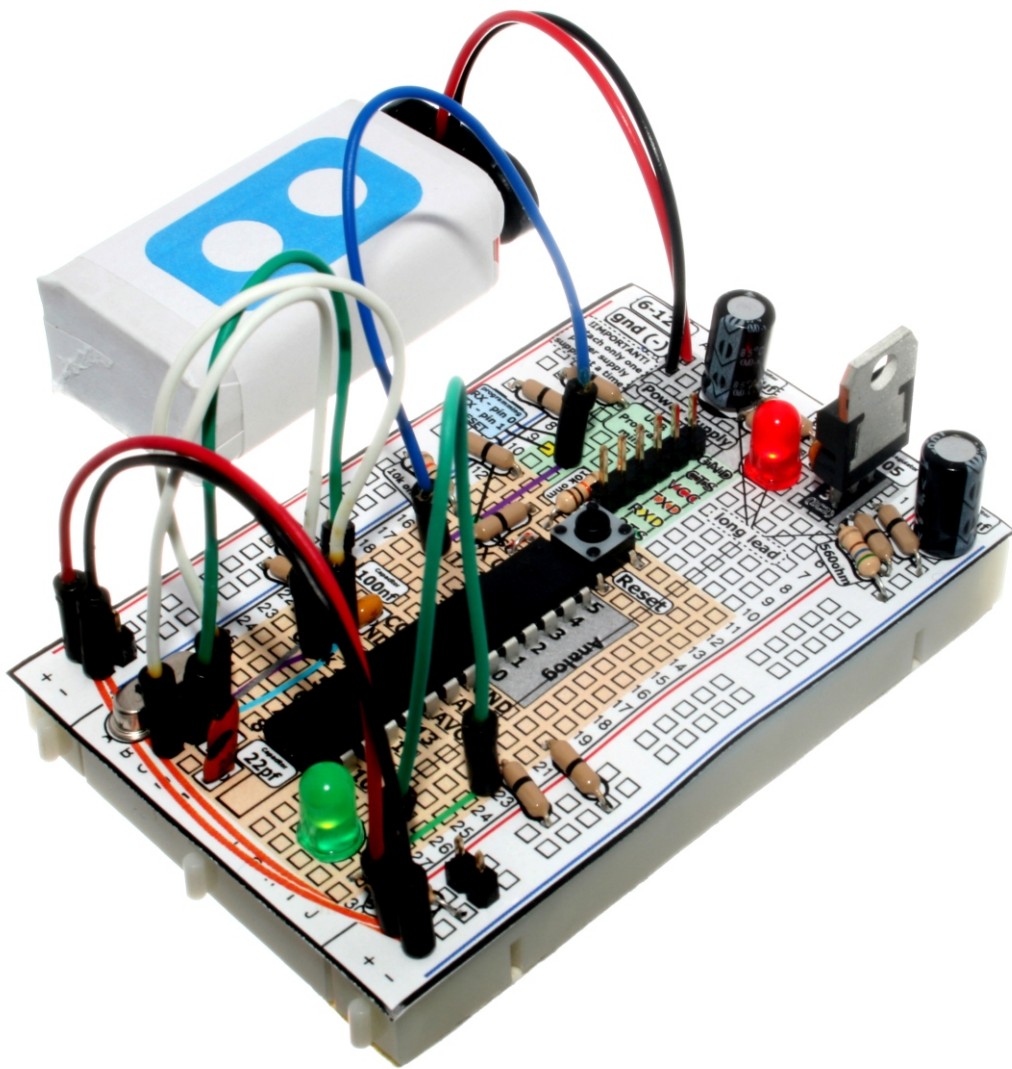

(BBAC)

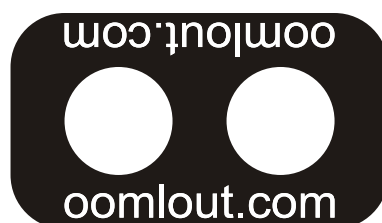

A Few Words

About this Kit

The pre-made Arduino Duemilanove board is an amazing prototyping platform, but sometimes its fun to make something for yourself. The goal of this kit is to make building your own a fun and easy experience. Collecting all the bits and pieces so you can pop them into place and have a fully functional Arduino compatible to play around with in no time.



About Open Source Hardware

All of .:oomlout:.'s projects are open source. What does this mean? It means everything involved in making this kit, be it this guide, 3D models, or code is available for free download. But it goes further, you're also free to reproduce and modify any of this material, then distribute it for yourself. The catch? Quite simple; it is released under a Creative Commons (By - Share Alike) license. This means you must credit .:oomlout:. in your design and share your developments in a similar manner. Why? We grew up learning and playing with open source software and the experience was good fun, we think it would be lovely if a similar experience was possible with physical things.

(more details on the Creative Commons CC (By - Share Alike) License can be found at)
(<http://tinyurl.com/2dkzmd>)

About .: oomlout :.

We're a plucky little design company focusing on producing
"delightfully fun open source products"

To check out what we are up to

<http://www.oomlout.com>

About Problems

We strive to deliver the highest level of quality in each and every thing we produce. If you ever find an ambiguous instruction, a missing piece, or would just like to ask a question, we'll try our best to help out. You can reach us at:

help@oomlout.com

(we like hearing about problems it helps us improve future versions)

Thanks For Choosing .:oomlout:.

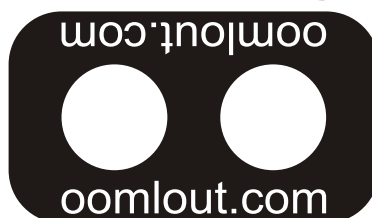

.: Where to Find Everything :.

{PART}	Required Parts	02
{COMP}	Comparing a BBAC to a Duemilanove	03
{SCHEM}	BBAC Schematic	04
{ASEM}	Assembly Instructions	05
{PROG}	Programming Instructions	08
{NOTE}	Room to Take Notes	09





01 PART

the parts

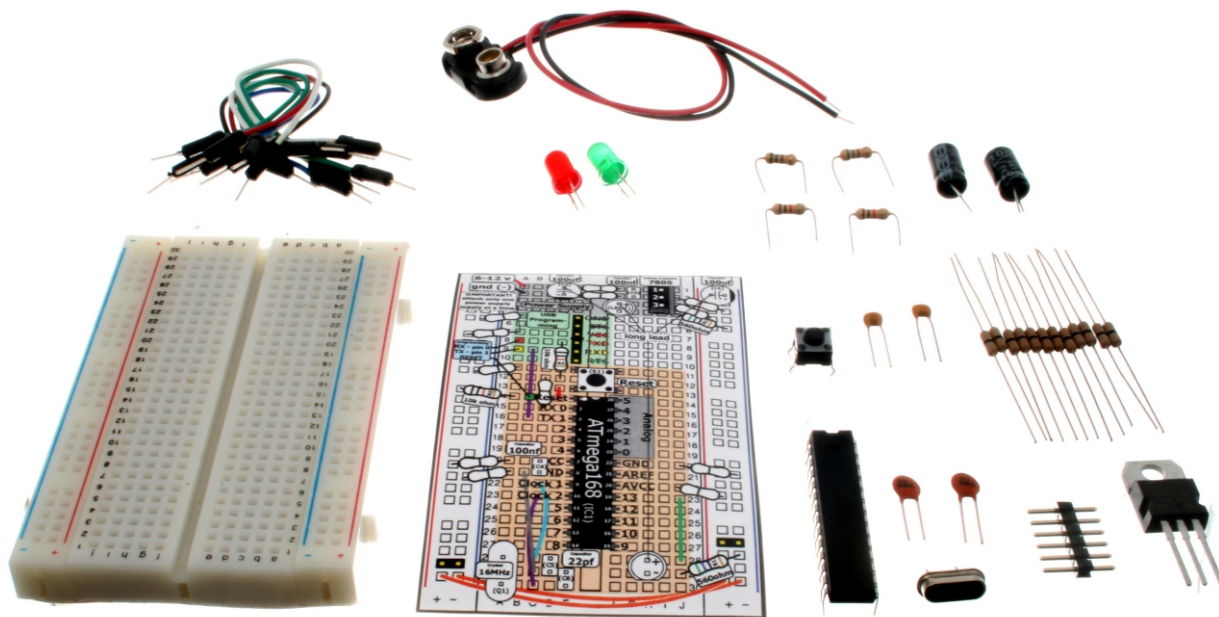

:: The Parts Needed for a :: :: Breadboard Arduino Compatible::



Capacitors

-  **100 uf** - filters the power supply
-  **100 nf** - bypass capacitor
-  **22 pf** - filters the crystal

Resistors

-  **0 ohm** (black)
used as jumper wires
-  **560 ohm** (green-blue-brown)
LED current limiting
-  **10k ohm** (brown-black-orange)
Pull-ups

Header - (6 pin)



Used for programming with an FTDI cable

Battery Clip - (9v)



For powering the board with a 9v battery

Breadboard

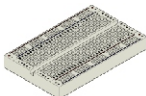

Allows for easy assembly of circuits without soldering

Crystal - (16 MHz)

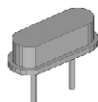

Provides a clock signal for the ATmega chip

Breadboard Layout Sheet

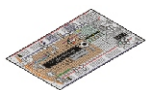

Place on top of a breadboard to show where components go

Microcontroller - (ATmega168)



A single chip computer that runs your code

Pushbutton - (Reset)

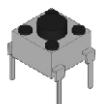

Resets the micro-controller when pressed

Voltage Regulator - (7805)



Takes in 7-12 volts and outputs 5 volts

LEDs- (Light Emitting Diodes)

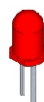
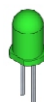

Used as indicators

Red - power

Green - connected to pin 13

∴ An Arduino Duemilanove: & ∴ Breadboard Arduino Compared∴

02 COMP
comparison

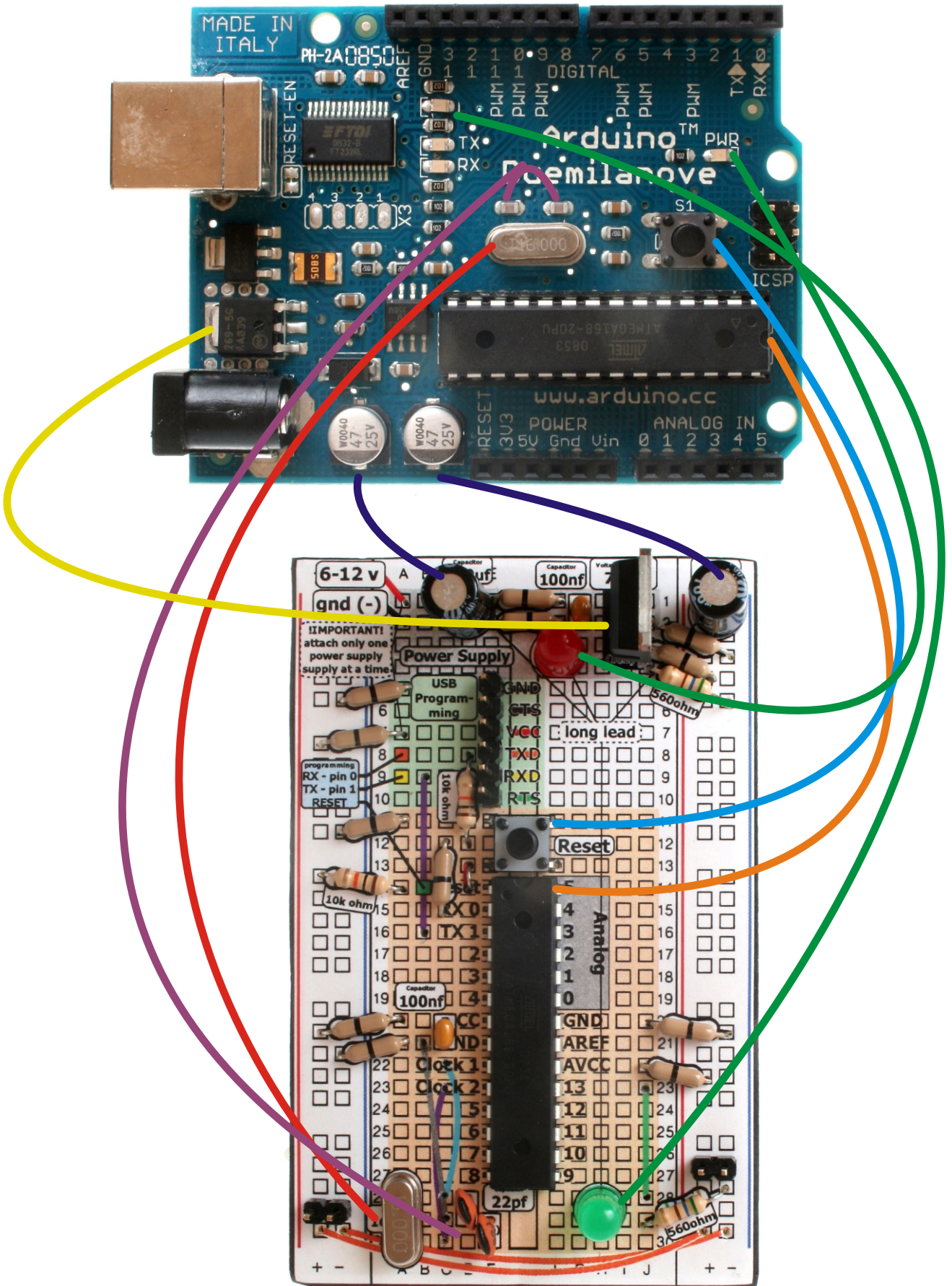

:: Breadboard Arduino Compatible ::

::Schematic::

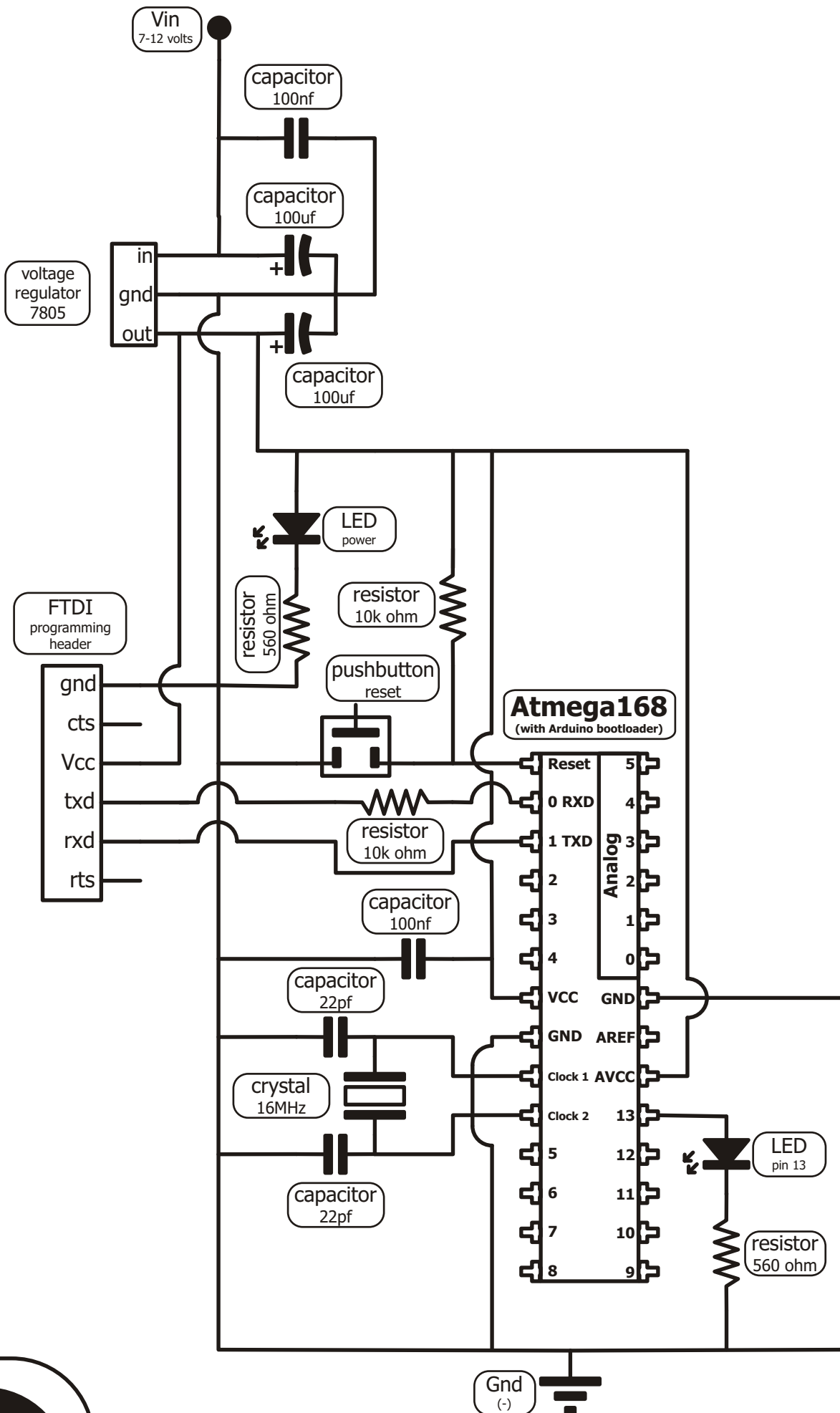

.: Breadboard Arduino Compatible.:.

04 ASEM

assembly

.:Assembly Steps.:.

Parts:



Breadboard
x1



Breadboard
Layout sheet
x1



2 Pin Header
x2

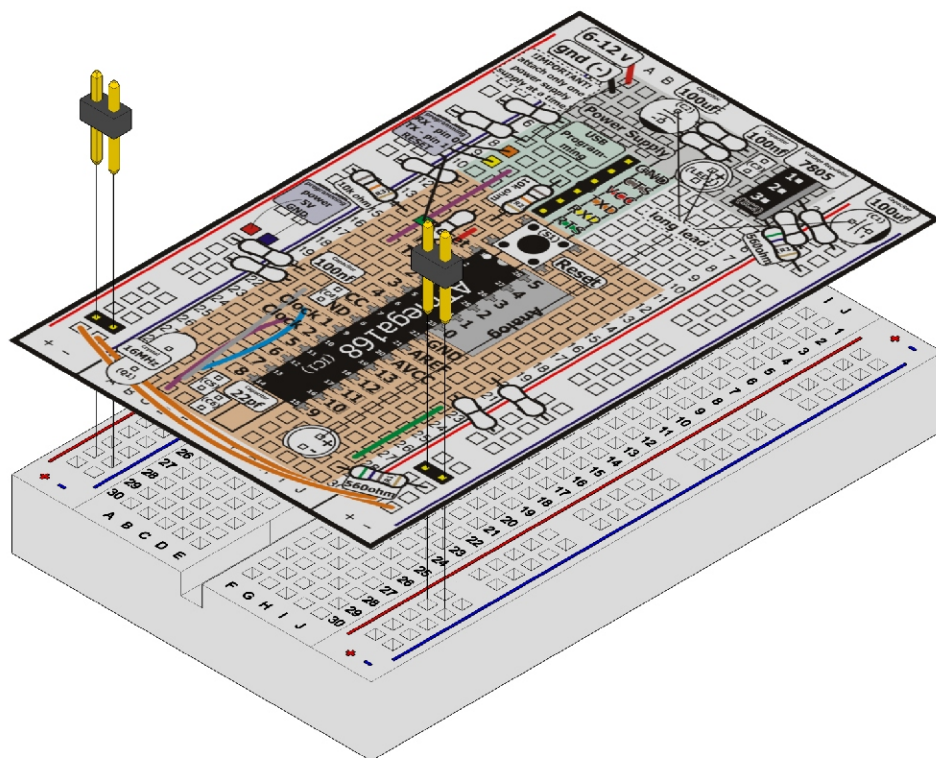

1

Parts:



0 ohm resistor
(black)
x12



560 ohm resistor
(green-blue-brown)
x2



10k ohm resistor
(brown-black-orange)
x2

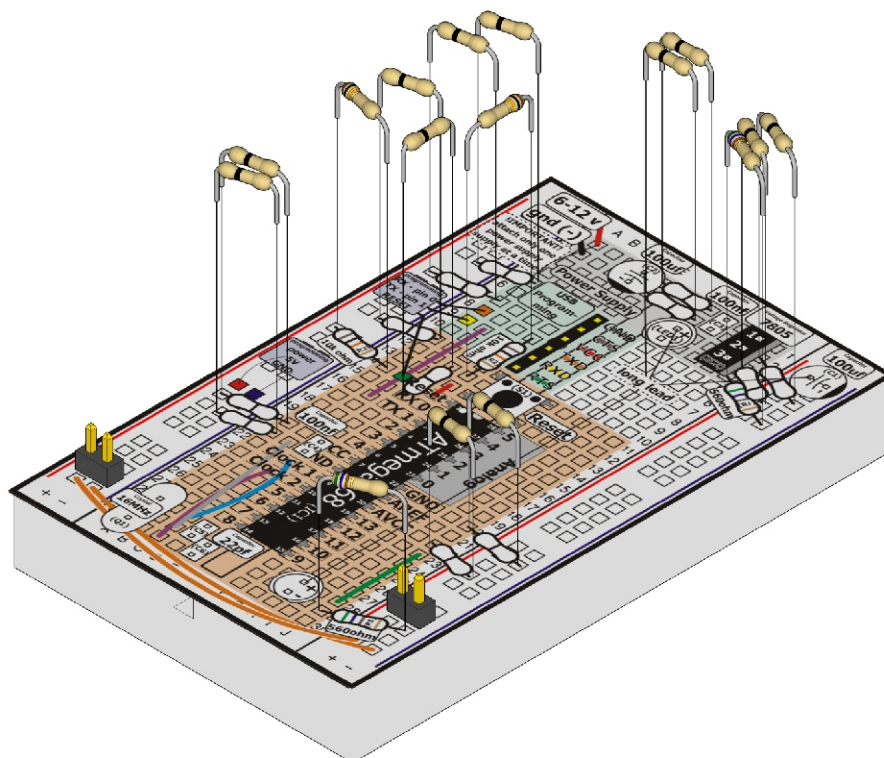

2

05

04 ASEM assembly

Parts:



Capacitor
100 uf
x2



Capacitor
100 nf
x2



Capacitor
22 pf
x2

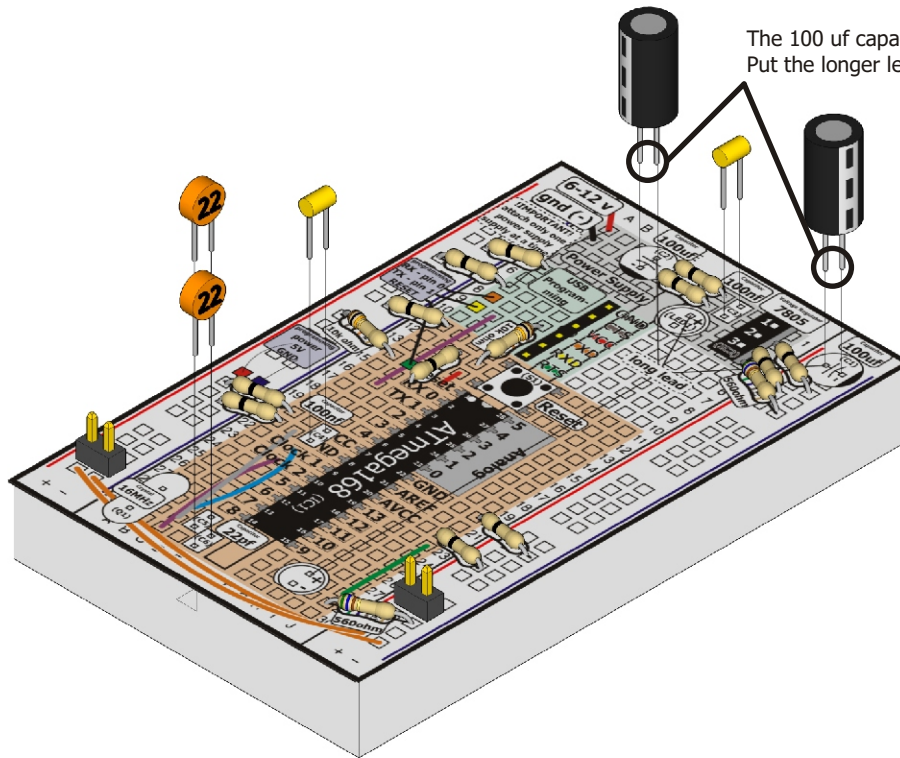

3

Parts:



Pushbutton
x1



Header (6 pin)
x1



Red LED
x1



Green LED
x1

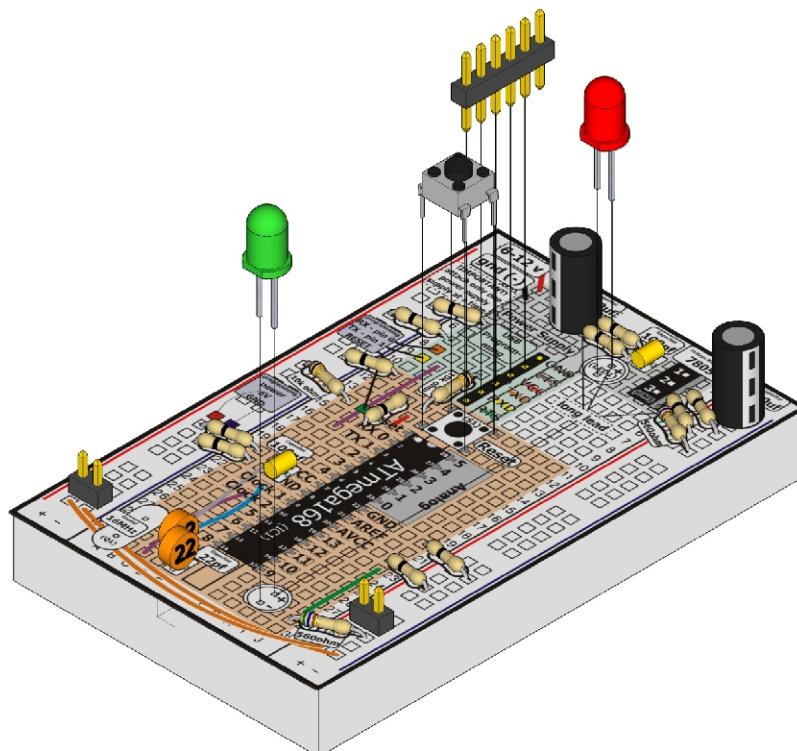

4

Parts:



Microcontroller
ATmega168
x1



Crystal
(16 MHz)
x1



Voltage Regulator
(7805)
x1

There is a half moon cutout, this goes at the top

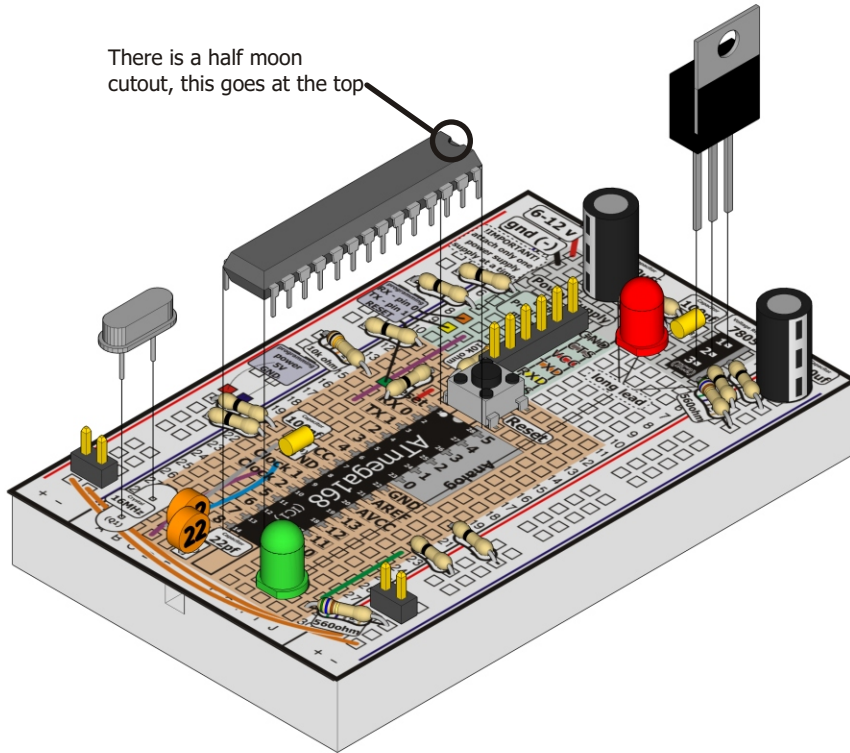

5

Parts:



Wire



Battery Clip
x1

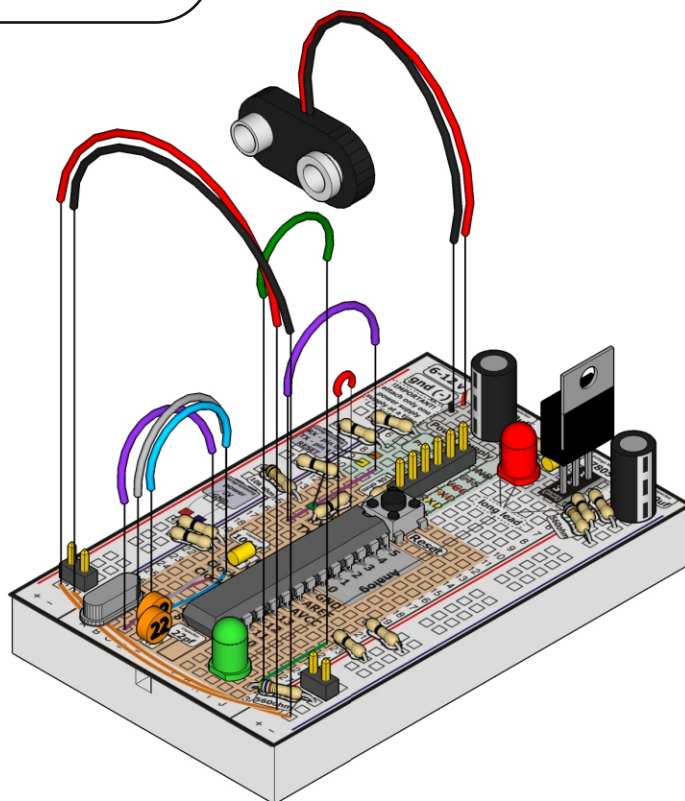

6

:: Programming Your Arduino Compatible::
(you can either use an Arduino Duemilanove board or an FTDI USB-Serial cable to program your BBAC)

Using an Arduino USB Board

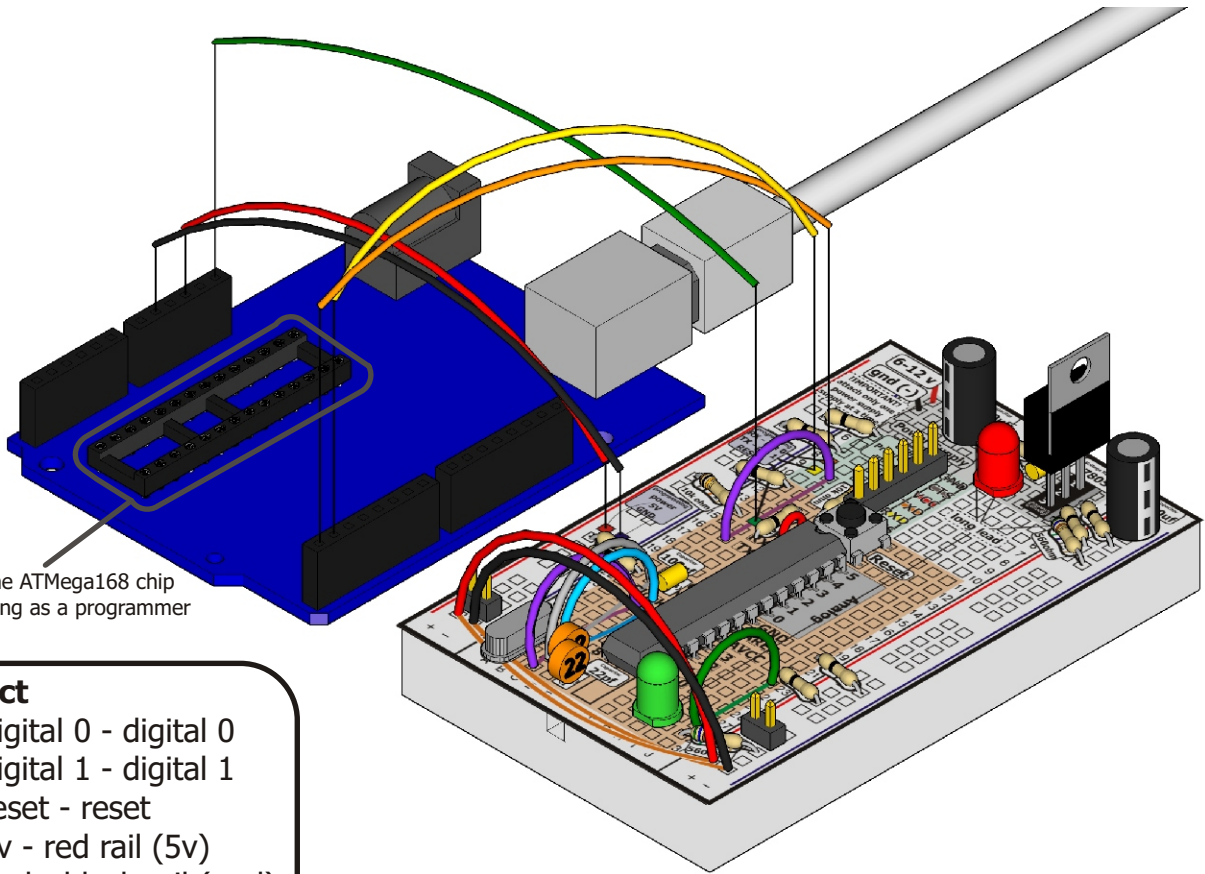

remove the ATmega168 chip
before using as a programmer

connect

1. digital 0 - digital 0
2. digital 1 - digital 1
3. reset - reset
4. 5v - red rail (5v)
5. gnd - black rail (gnd)

Using an FTDI USB - Serial Cable

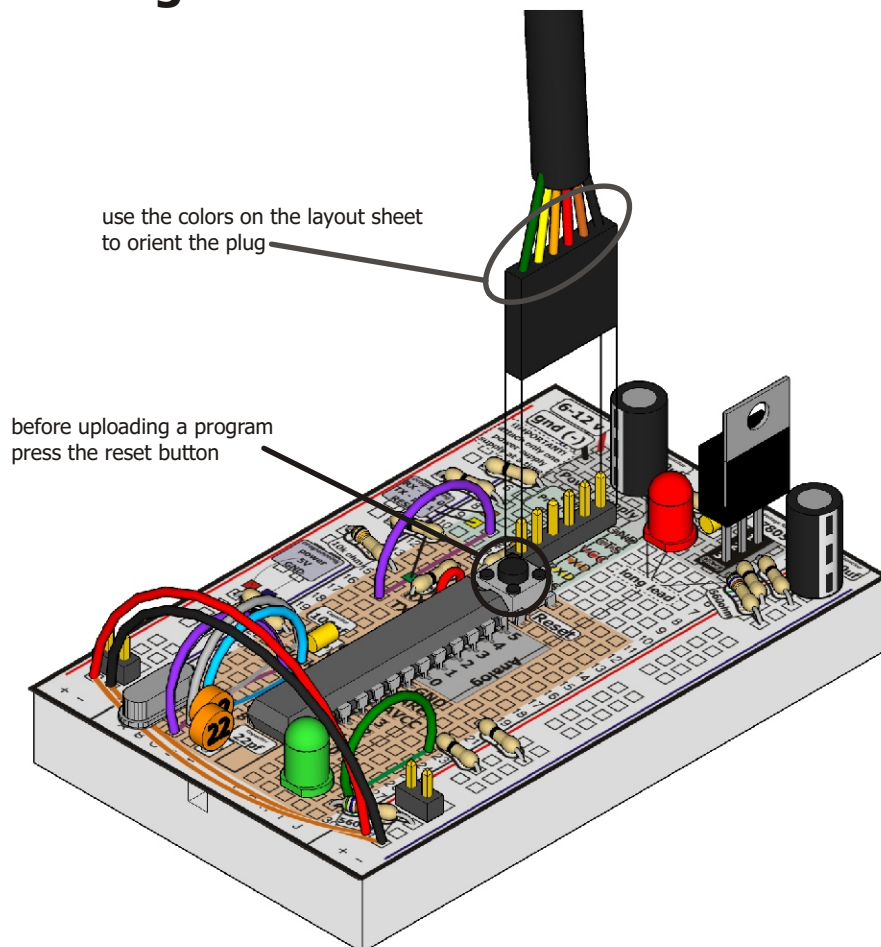

use the colors on the layout sheet
to orient the plug

before uploading a program
press the reset button

∴ Notes∴

∴Room for a Few Notes∴

06 NOTE
notes

A large rectangular area with rounded corners, filled with horizontal lines for writing notes. The lines are evenly spaced and extend across the width of the page, leaving a small margin at the top and bottom.

(BBAC)
breadboard arduino
compatible

www.oomlout.com

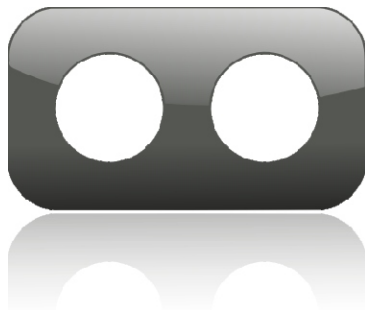

This work is licenced under the Creative Commons Attribution-Share Alike 3.0 Unported License. To view a copy of this licence, visit <http://creativecommons.org/licenses/by-sa/3.0/> or send a letter to Creative Commons, 171 Second Street, Suite 300, San Francisco, California 94105, USA.