

# *RasPiBox Open Plus*

## *Version 2.x*

### *construction manual*

Rev.	Date	Description
A	2015-02-06	English translation of German version
B	2015-05-04	Small bugfixes
C	2016-04-26	Changes for new RasPiBox version 1.2
D	2019-07-02	Changes for new RasPiBox version 2.x

## *Tools:*

*agregulated soldering iron  
(25..40W) with small tip*



*a wet sponge to clean the  
tip*



*thin solder wire*



Side cutting pliers







Needle nose pliers



Medium cross slot screwdriver

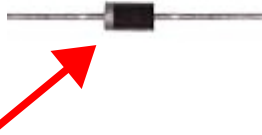
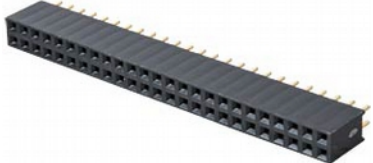

*Parts Basic Version:*

 <p>2x 2pole terminal block (5mm)</p>	 <p>1x 3pole terminal block (5mm)</p>	 <p>1x 2pole terminal block (7,5 mm) K1</p>
 <p>2x self-tapping screws</p>	 <p>1x Schottky diode SB260 D3</p>	 <p>1x 2x20 female header</p>

## 1.) Assemble and solder the Diode D3

You've to place and solder the diode D3 first:

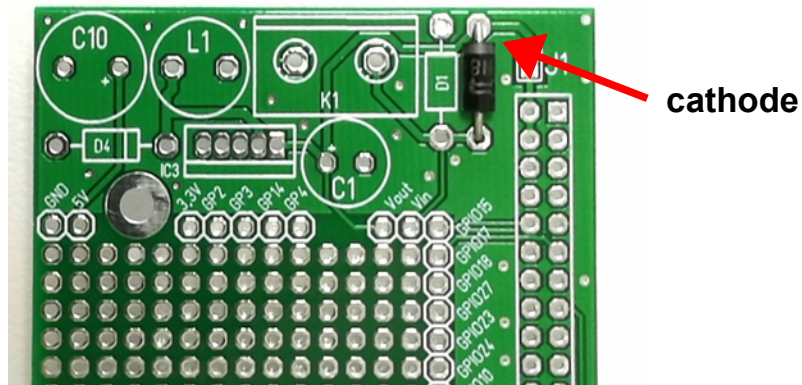

## 2.) Assemble and solder the female header

You've to place and solder the 2x20 pin socket for the Raspberry Pi now:

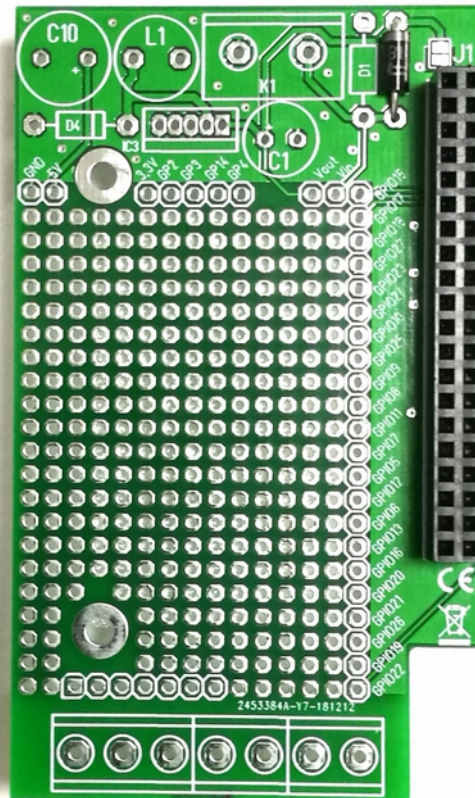

### 3.) *Prepare the 5mm terminal blocks*

*Find the 5mm terminal blocks, they're grey or blue and come in 3-pin and 2-pin shapes. You'll need to slide one 3-pin and two 2-pin blocks together:*

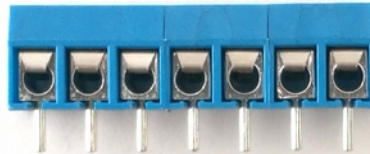

### 4.) *Place and solder terminal blocks*

*You've to put the blocks into the proto plate. Make sure you place them so that the open ends are facing out as shown:*

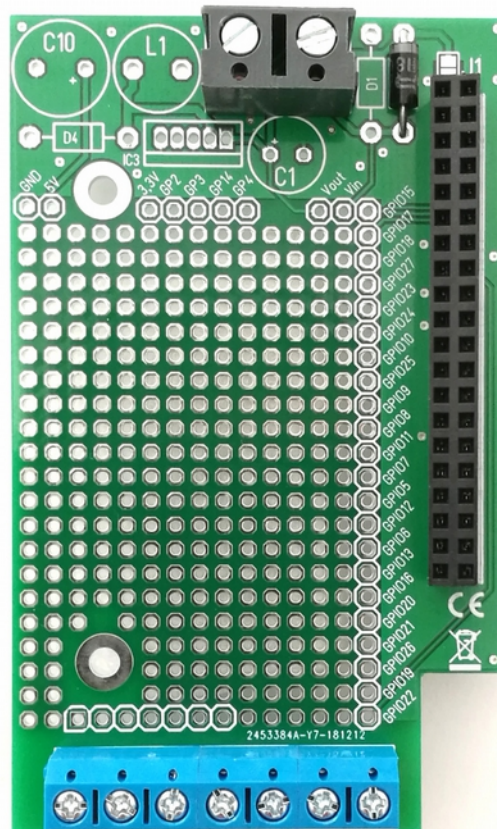



### 5.) Link the 5V power signal to the terminal (option)



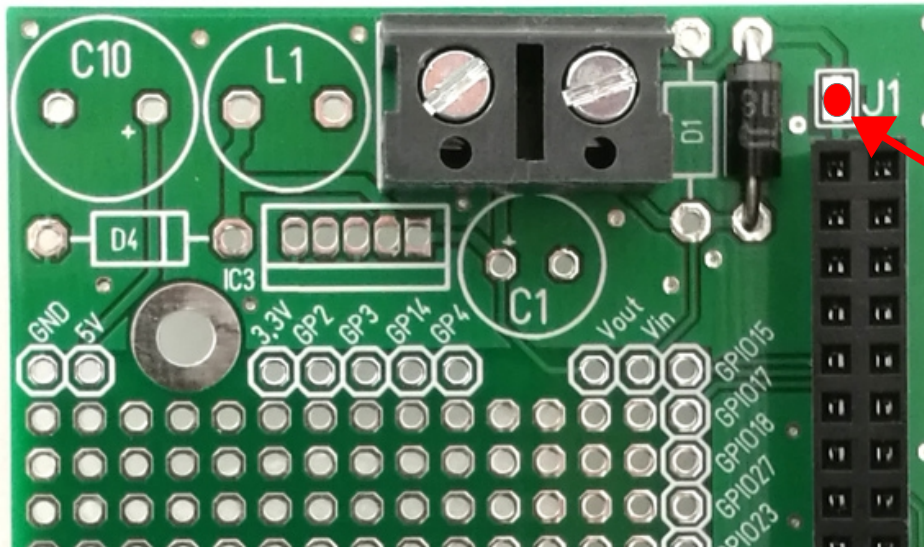

**Perform this step only if you really don't want to use the additional voltage regulator of the standard kit. If you want to use the micro usb power socket of the Raspberry Pi this step is unnecessary also.**

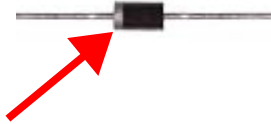

*Bridge jumper J1 with solder*

**Perform the next steps only if you have the standard kit (includes the parts of the voltage regulator). Otherwise continue with step 11.**

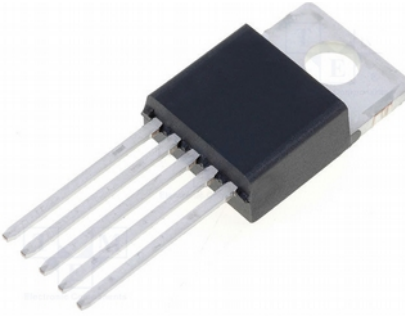
## *Additional parts of Standard Version:*

 <p>1x inductor 100uH/1.2A (L1)</p>	 <p>1x Schottky diode SB260 (D3)</p>	 <p>1x overvoltage limiting diode P6KE36CA (D1)</p>
 <p>1x voltage regulator TL2576-5 (IC1)</p>	 <p>1x electrolytic capacitor 100uF/63V (C1)</p>	 <p>1x electrolytic capacitor 1000uF/16V (C10)</p>



*Power supply circuit:*

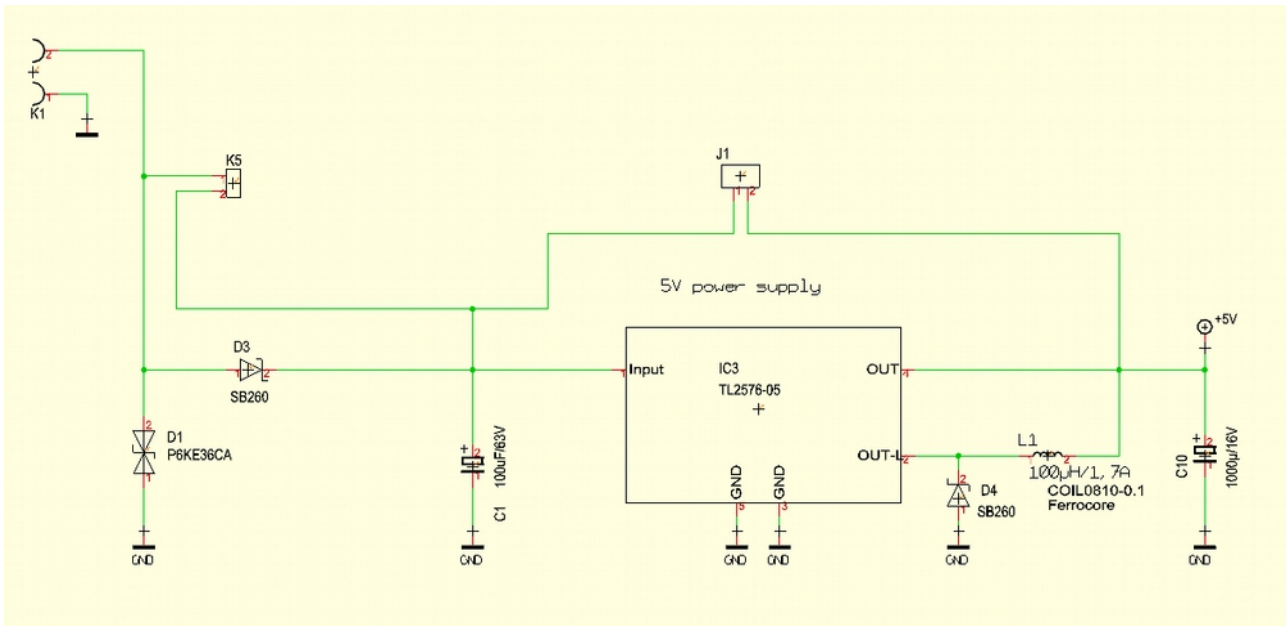

*Placement:*

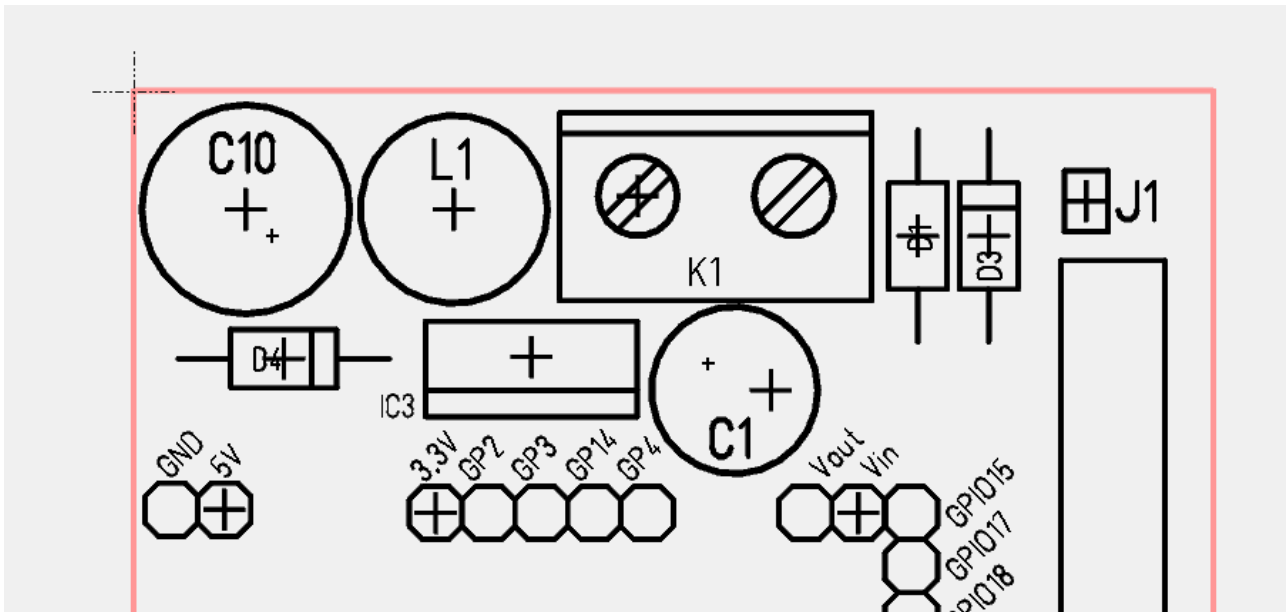

6.) Assemble Diode D1 and D4

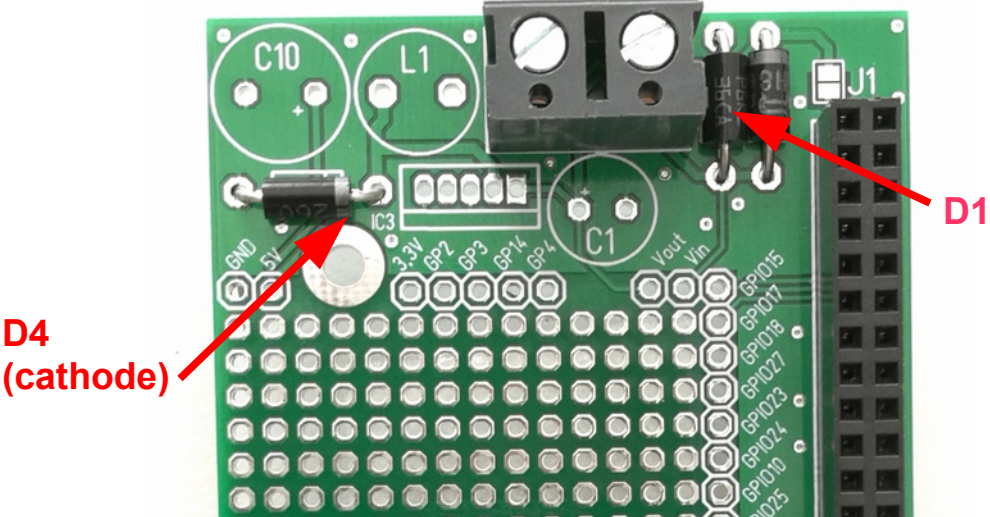

*Pls Note: D1 has no polarity!*

7.) Assemble the coil L1

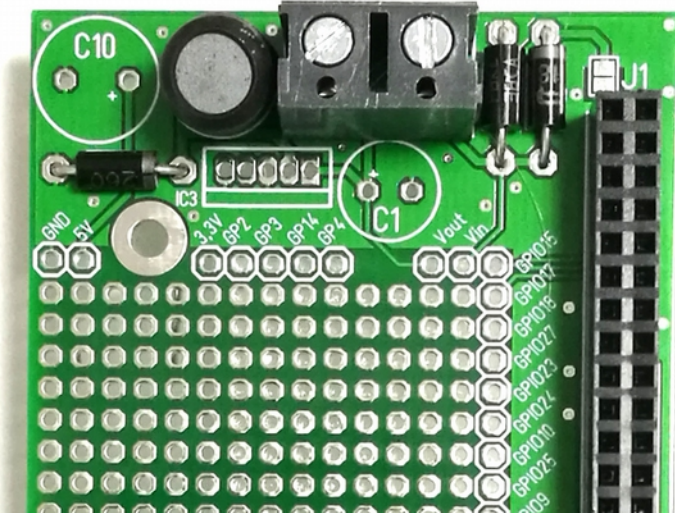

8.) Assemble the electrolytic capacitor C1 (100uF)

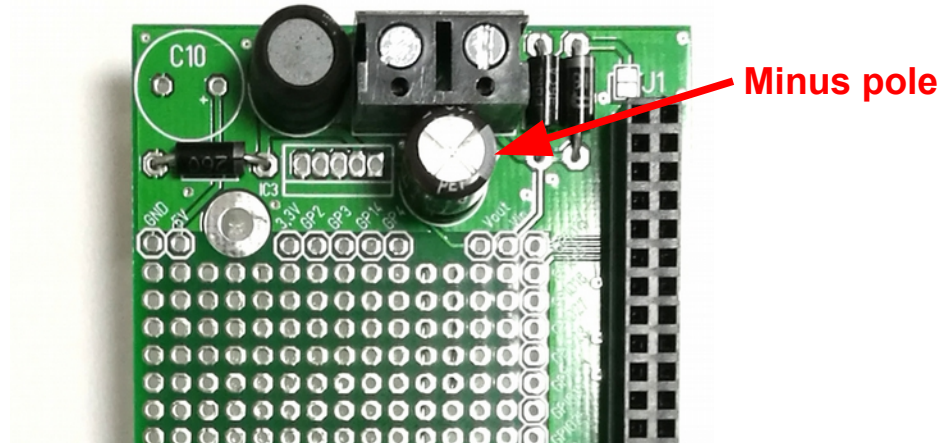

9.) Assemble the electrolytic capacitor C10 (1000uF)

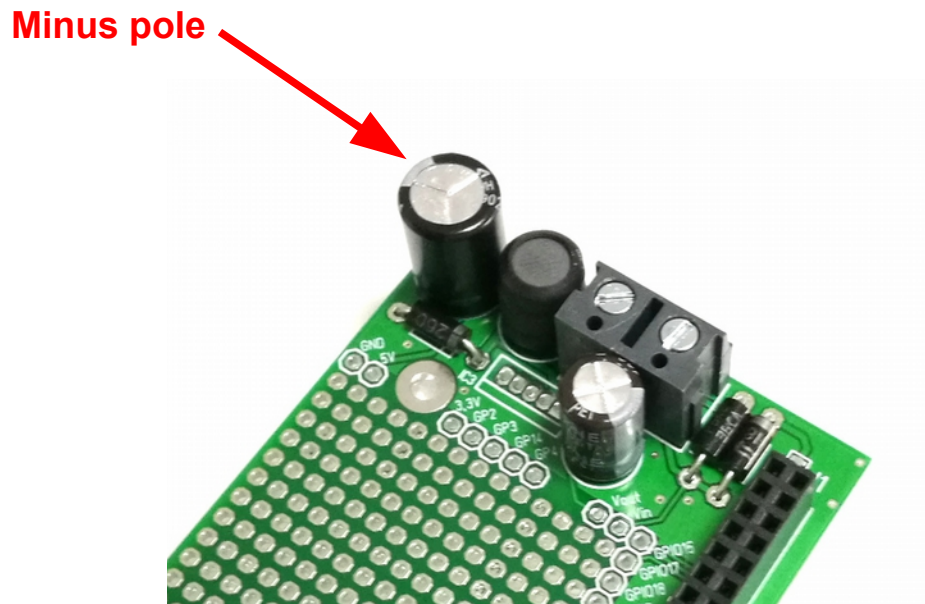

## 10.) Assemble the voltage regulator IC1

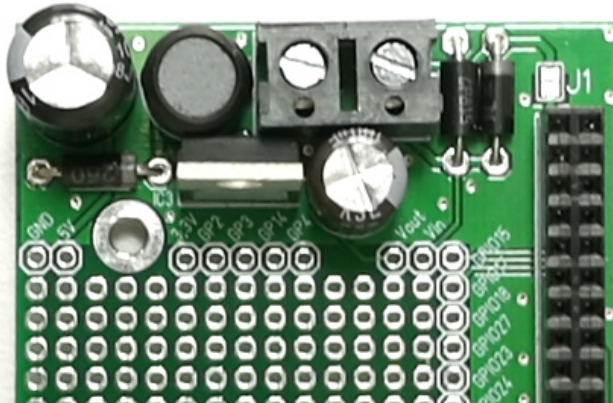

**Note: Please take care that the jumper J1 is not be bridged.**



## 11.) Mount the pcb into the bottom shell

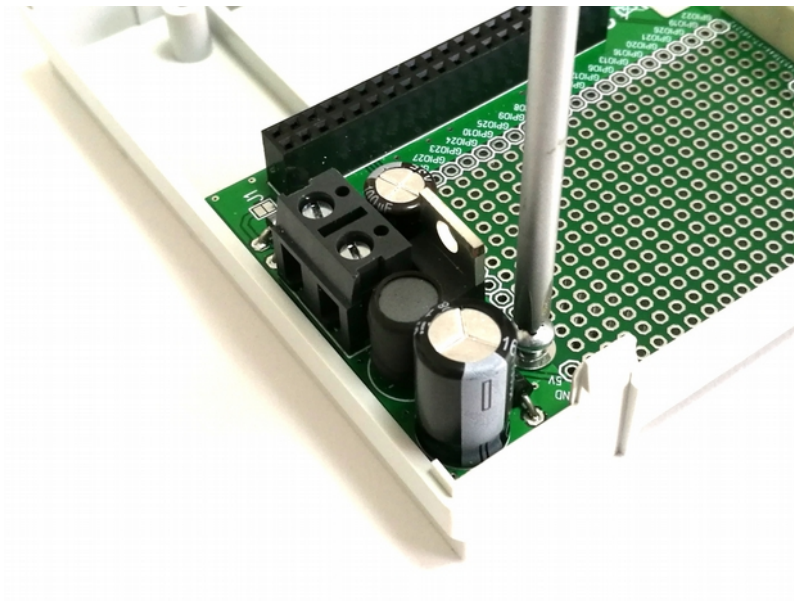

## 12.) Open the terminal covers

Depending on the used terminals you have to remove the terminal covers of the top shell. These covers comes with rated break points. You can remove it with a screw driver and a nose pliers:



**13.) Mount the Raspberry Pi!**



**14.) Mount the top shell**



***Finish!***