

Dept.	Technical reference	Created by Piyush Kushwaha 12/25/2021	Approved by		
		Document type	Document status		
		Title Power stroke 3d printer	DWG No.		
		Rev.	Date of issue	Sheet 1/1	

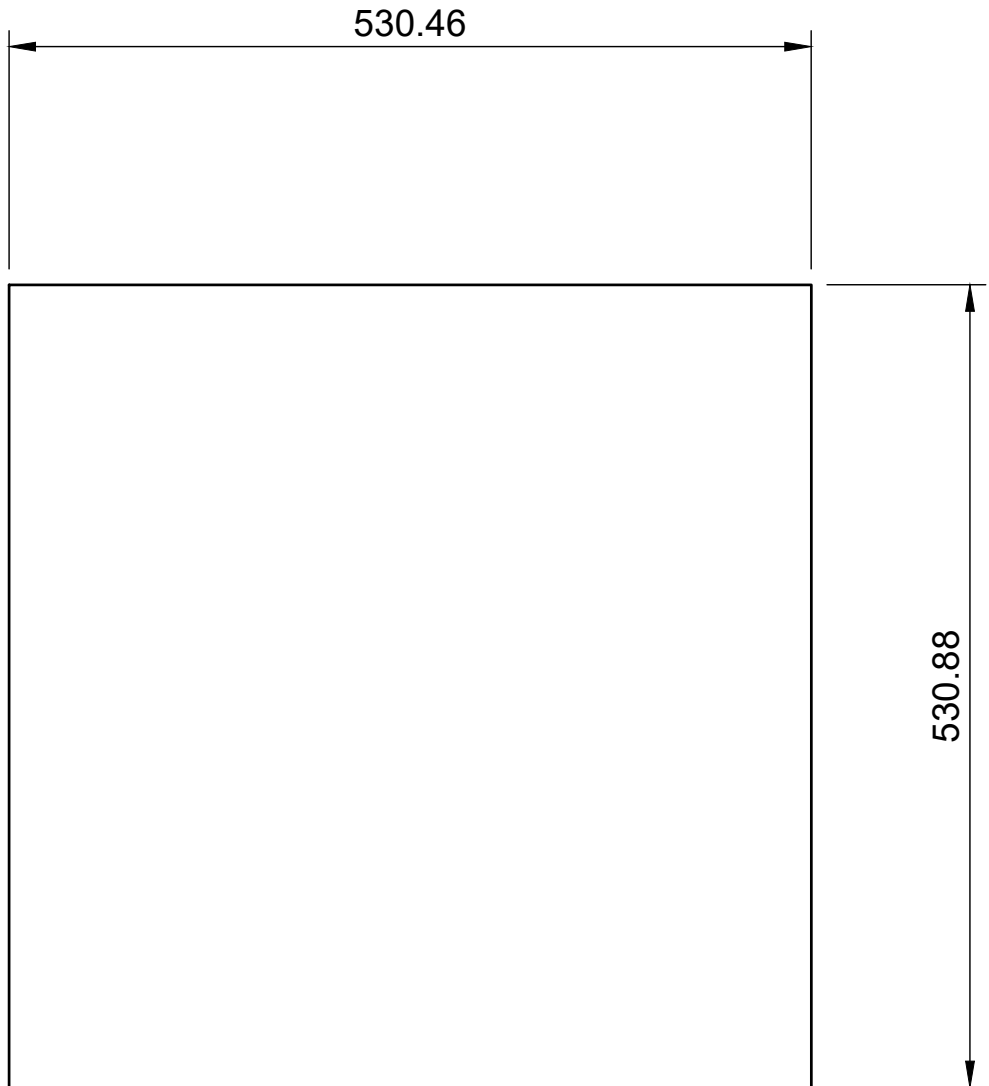

Dept.	Technical reference	Created by Piyush Kushwaha 12/25/2021	Approved by		
		Document type	Document status		
		Title Power stroke 3d printer Base	DWG No.		
		Rev.	Date of issue	Sheet 1/1	

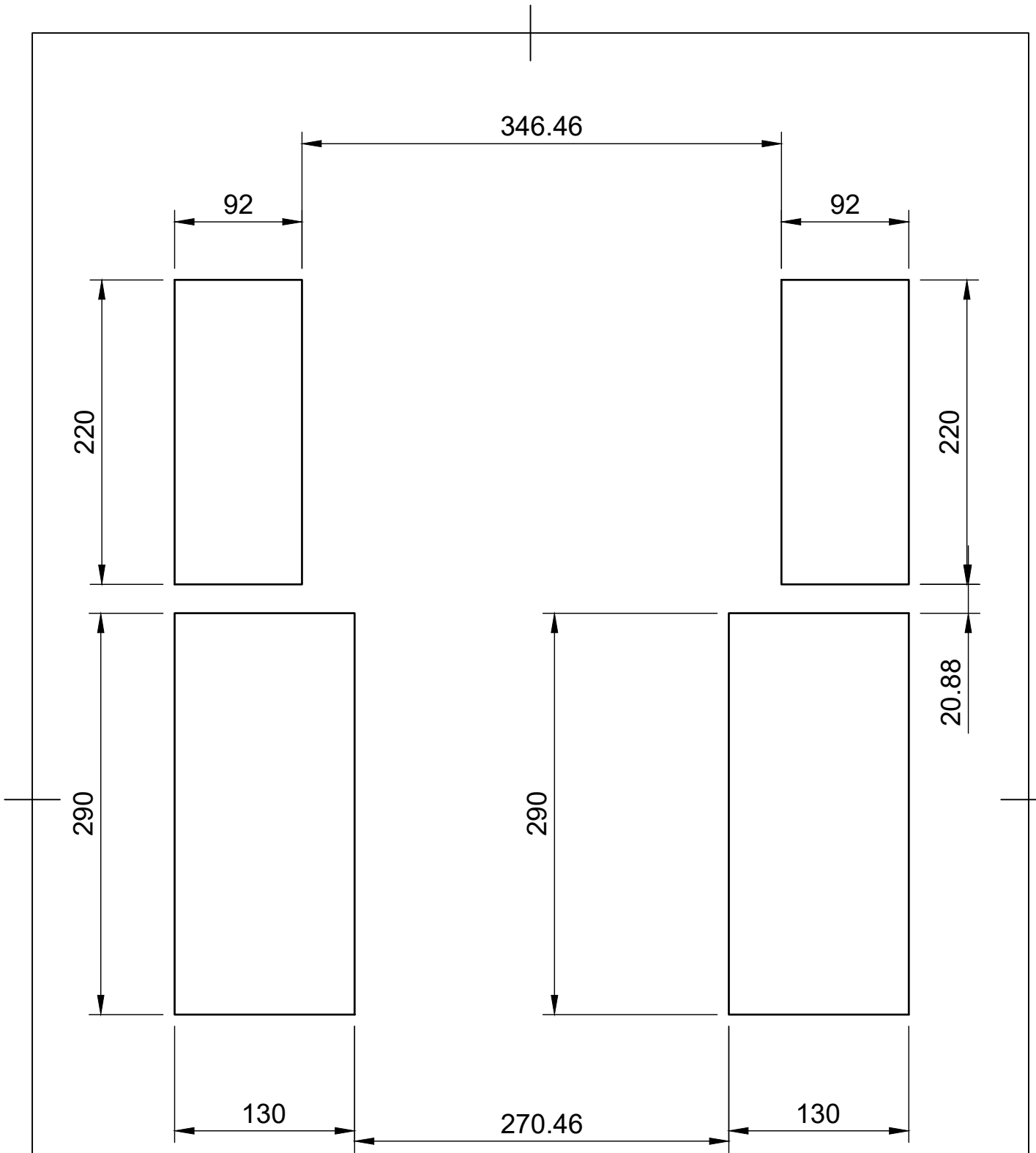

Dept.	Technical reference	Created by Piyush Kushwaha 12/25/2021	Approved by	
		Document type	Document status	
		Title Power stroke 3d printer	DWG No.	
		Rev.	Date of issue	Sheet 1/1

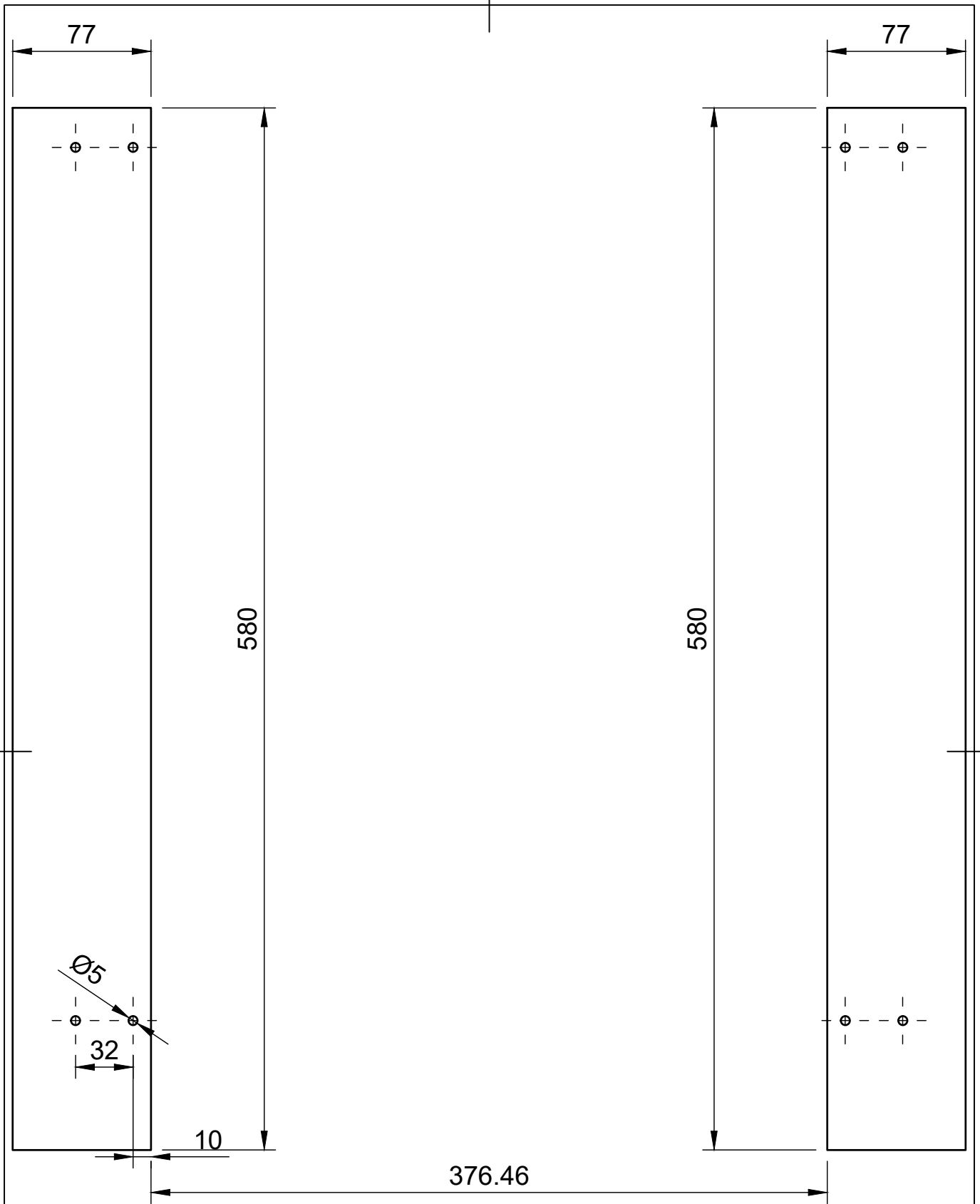

Dept.	Technical reference	Created by Piyush Kushwaha 12/25/2021	Approved by	
		Document type	Document status	
		Title Power stroke 3d printer	DWG No.	
		Rev.	Date of issue	Sheet 1/1

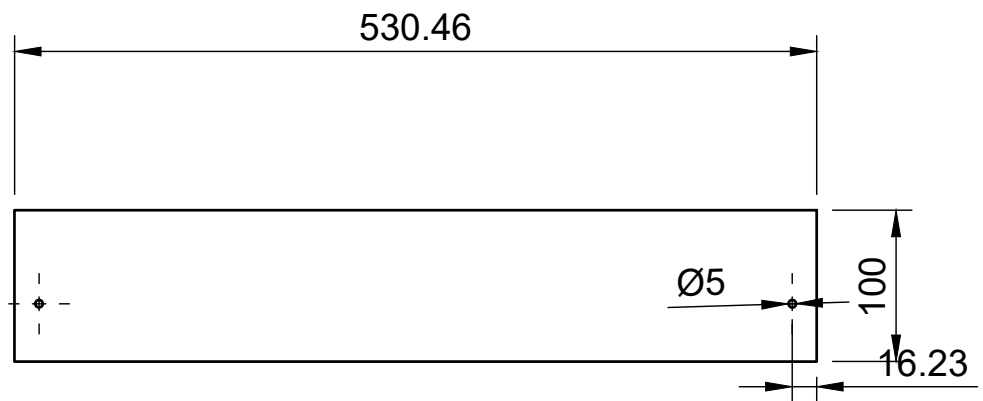

Dept.	Technical reference	Created by Piyush Kushwaha 12/25/2021	Approved by		
		Document type	Document status		
		Title Power stroke 3d printer	DWG No.		
		Rev.	Date of issue	Sheet 1/1	

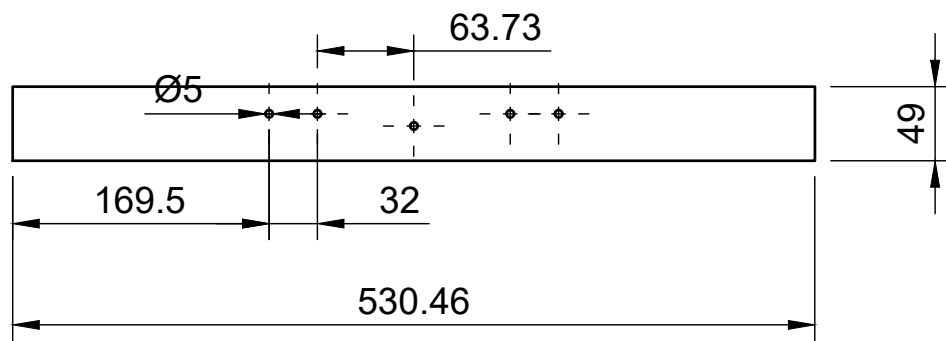
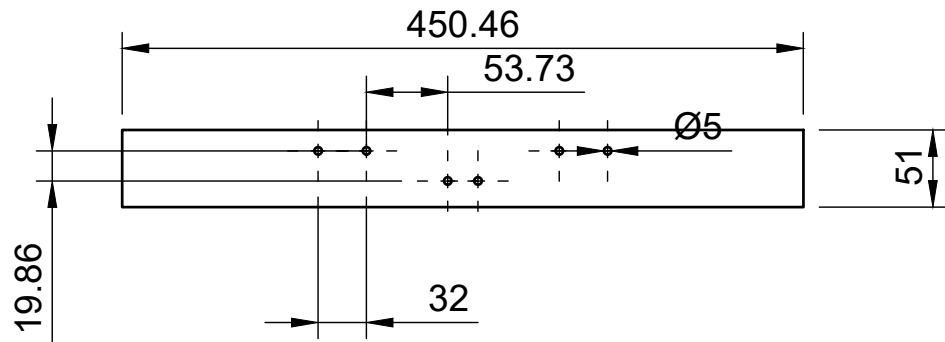

Dept.	Technical reference	Created by Piyush Kushwaha 12/25/2021	Approved by		
		Document type	Document status		
		Title Power stroke 3d printer	DWG No.		
		Rev.	Date of issue	Sheet 1/1	

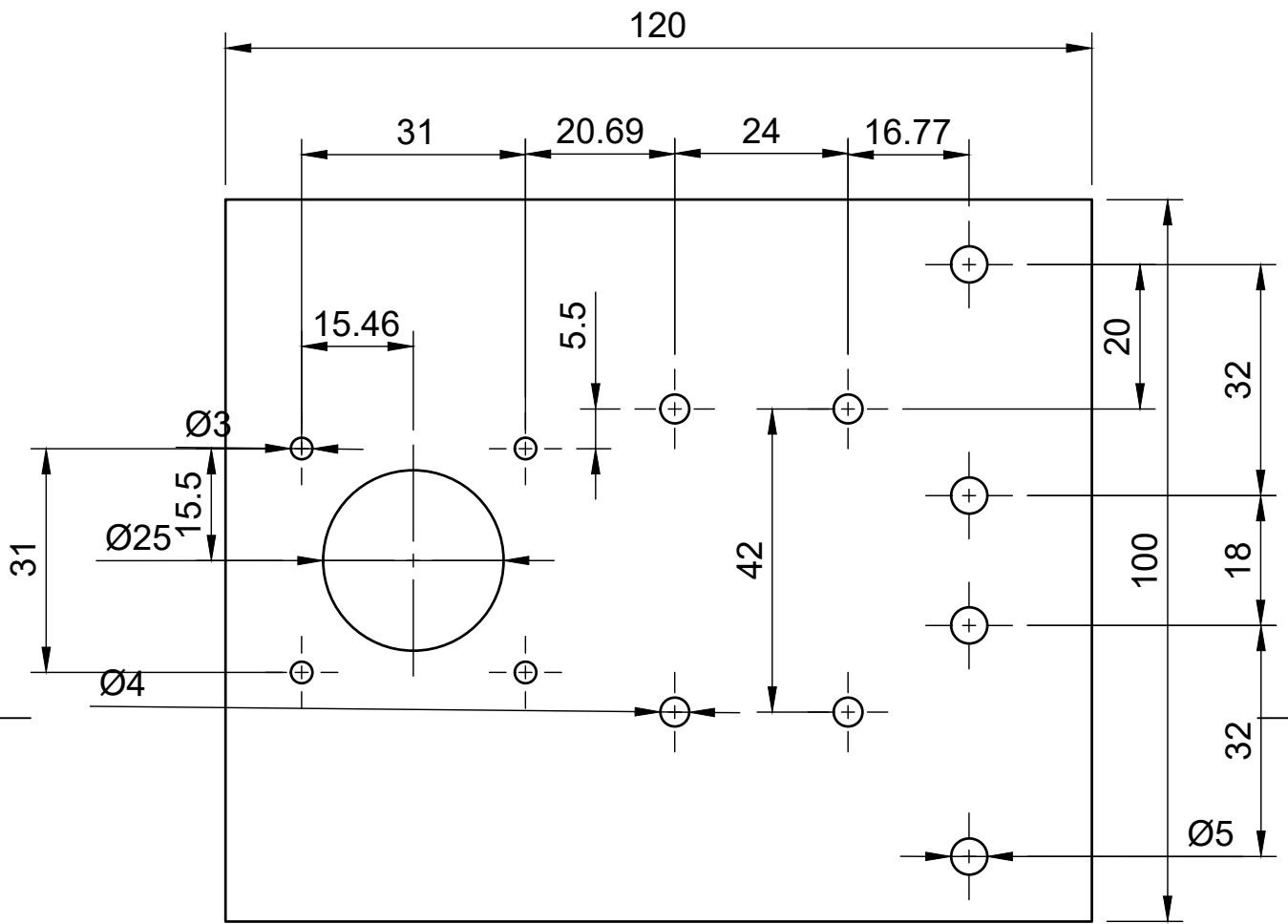

Dept.	Technical reference	Created by Piyush Kushwaha 12/25/2021	Approved by	
		Document type	Document status	
		Title Power stroke 3d printer	DWG No.	
		Rev.	Date of issue	Sheet 1/1

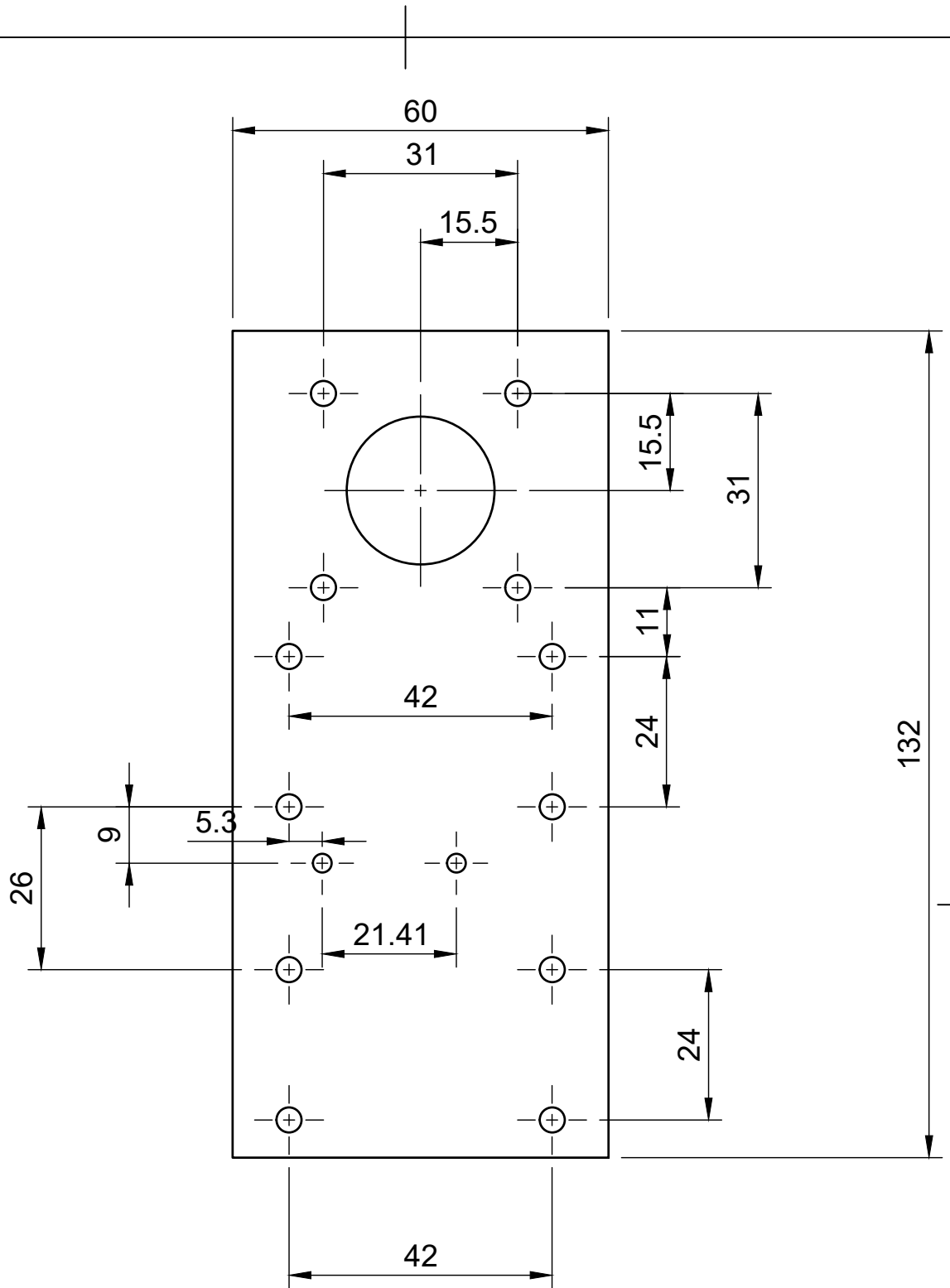

Dept.	Technical reference	Created by Piyush Kushwaha 12/25/2021	Approved by	
		Document type	Document status	
		Title Power stroke 3d printer	DWG No.	
		Rev.	Date of issue	Sheet 1/1

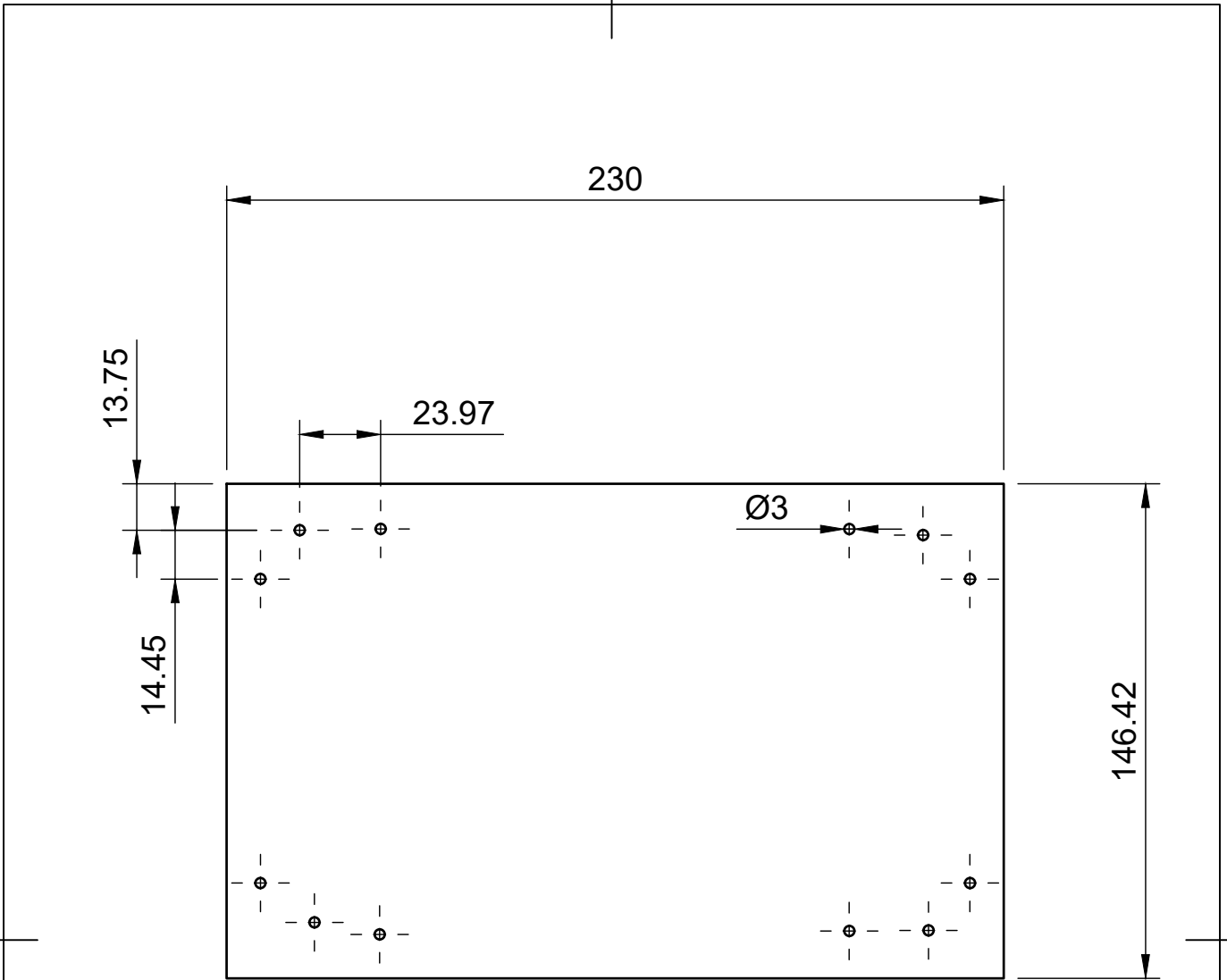

Dept.	Technical reference	Created by Piyush Kushwaha 12/25/2021	Approved by	
		Document type	Document status	
		Title Power stroke 3d printer	DWG No.	
		Rev.	Date of issue	Sheet 1/1

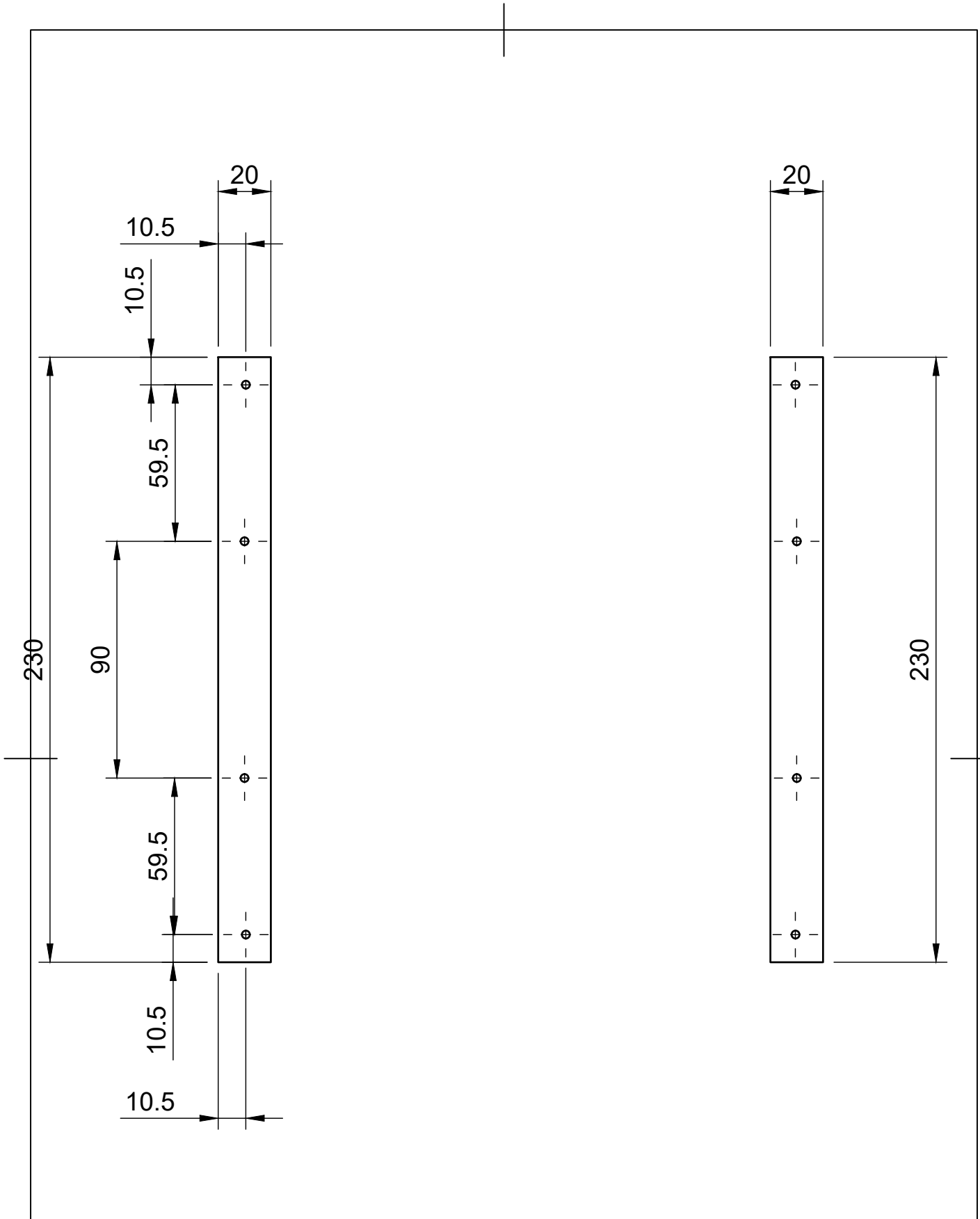

Dept.	Technical reference	Created by Piyush Kushwaha 12/25/2021	Approved by		
		Document type	Document status		
		Title Power stroke 3d printer	DWG No.		
		Rev.	Date of issue	Sheet 1/1	

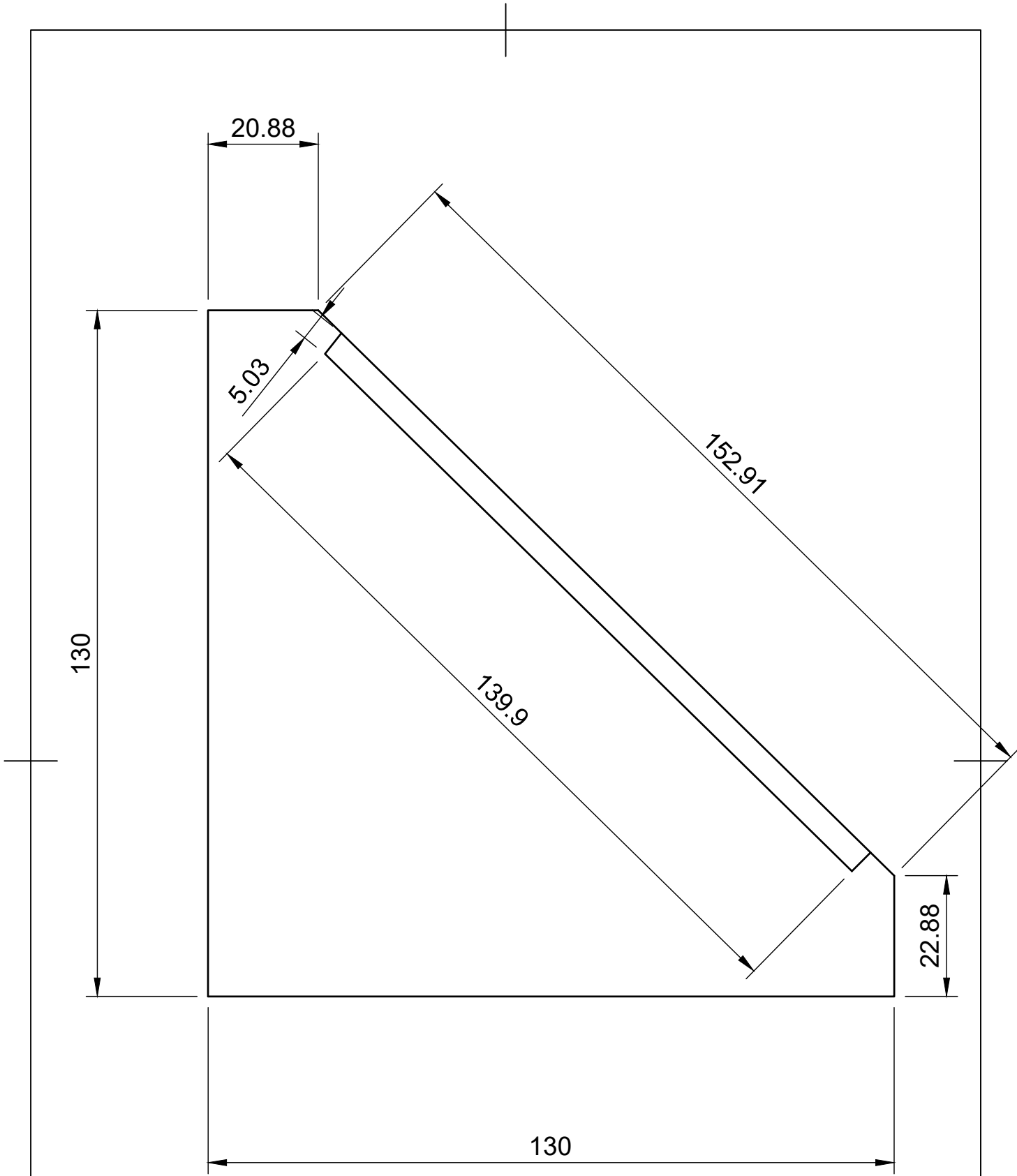

Dept.	Technical reference	Created by Piyush Kushwaha 12/25/2021	Approved by	
		Document type	Document status	
		Title Power stroke 3d printer	DWG No.	
		Rev.	Date of issue	Sheet 1/1

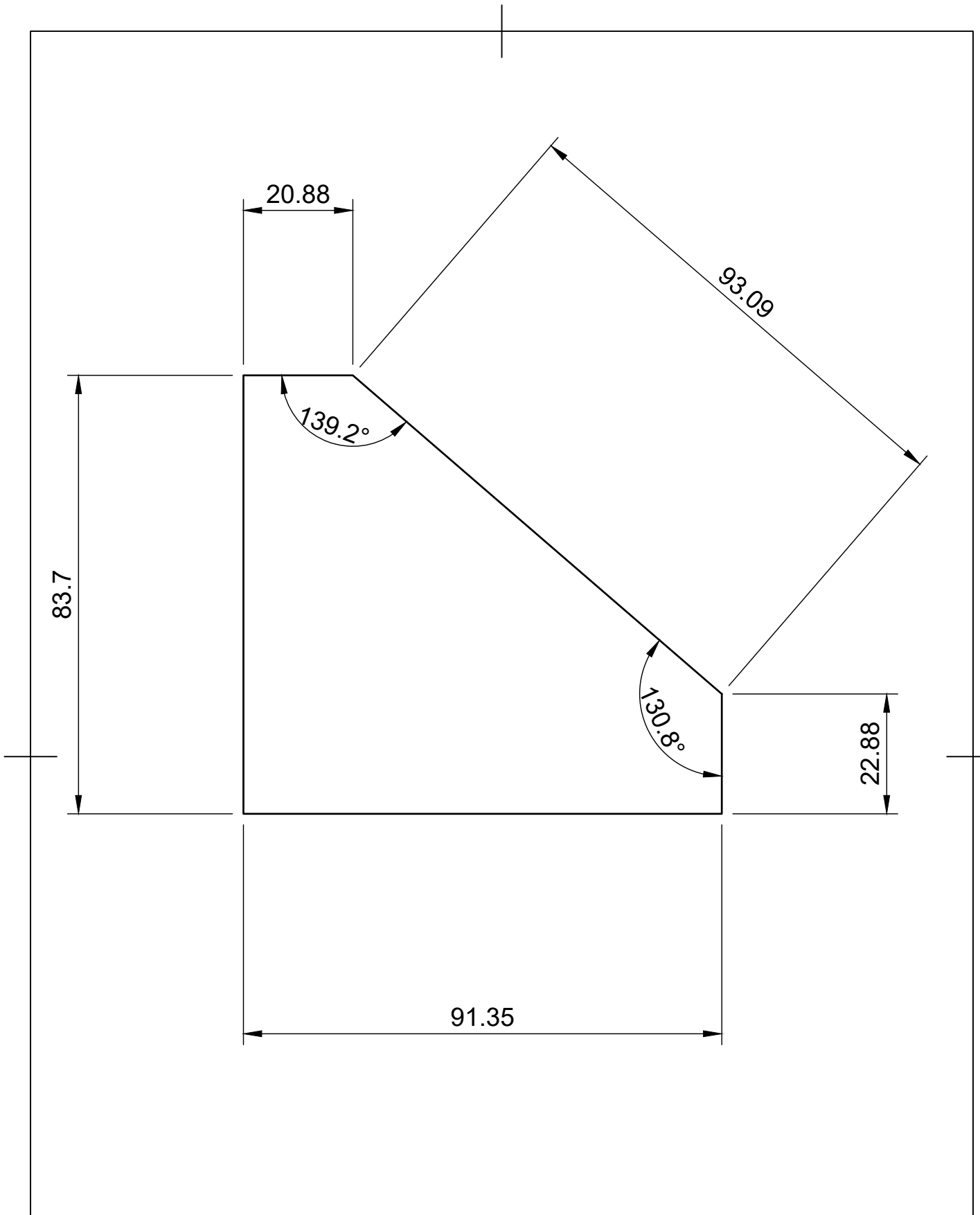

Dept.	Technical reference	Created by Piyush Kushwaha 12/25/2021	Approved by		
		Document type	Document status		
		Title Power stroke 3d printer	DWG No.		
		Rev.	Date of issue	Sheet 1/1	

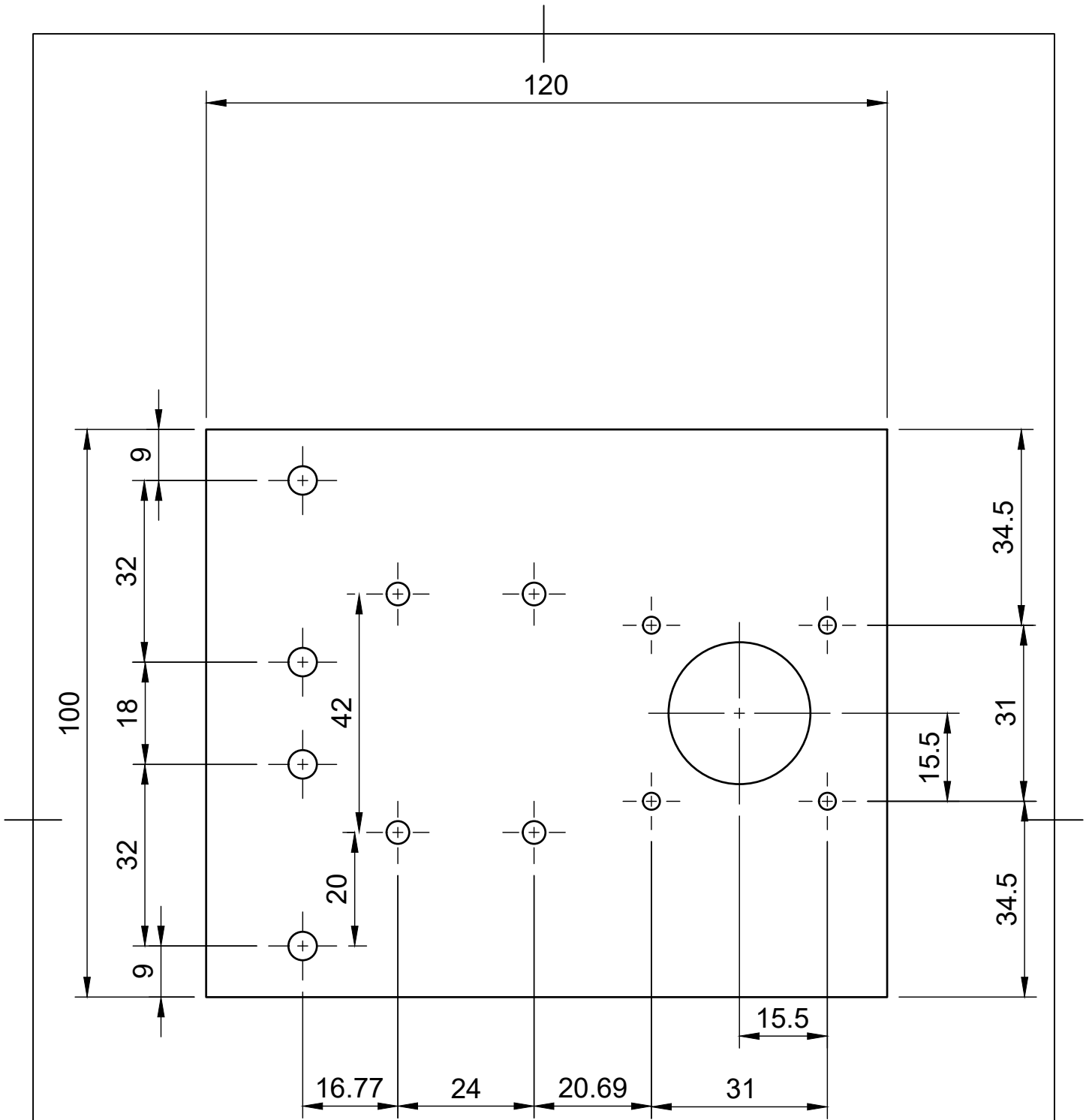

Dept.	Technical reference	Created by Piyush Kushwaha 12/25/2021	Approved by	
		Document type	Document status	
		Title Power stroke 3d printer	DWG No.	
		Rev.	Date of issue	Sheet 1/1

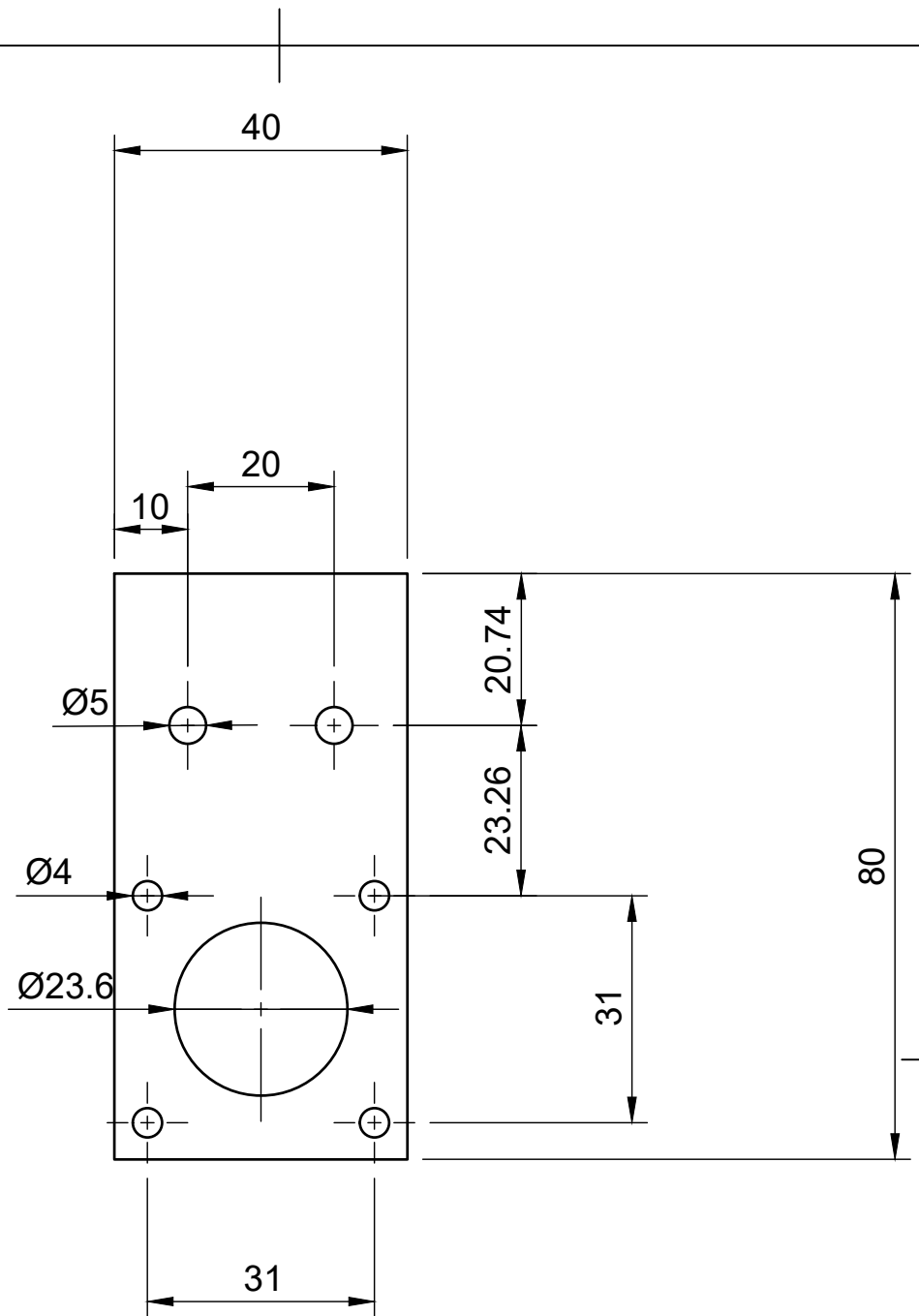

Dept.	Technical reference	Created by Piyush Kushwaha 12/25/2021	Approved by		
		Document type	Document status		
		Title Power stroke 3d printer	DWG No.		
		Rev.	Date of issue	Sheet 1/1	