

# Coolmay HMI Programming Manual

Shenzhen Coolmay Technology Co., Ltd

V1810

## Safety Precautions

(Always read these precautions before using this equipment.)



1. When the external power supply is abnormal or the control system malfunctions, in order to make sure the whole system being safely performed, please set a safety circuit outside it.
2. If the system cannot check out the abnormal conditions Of inputs and outputs, it cannot control output anymore. To ensure the element being operated safety, please design an external circuit and system.











1. Please read this manual before installation.
2. Do not disassemble the main box and the keyboard without authorization.
3. Please make a call to the after sale service center of Coolmay if you have any questions.



















### Precautions while testing and operating





















1. Before performing the test operations of the user creation monitor screen (such as turning ON or OFF bit element, change the word element current value, changing the settings or current values of the timer or counter, and changing the buffer memory current value), read through the manual carefully and make yourself familiar with the operation method.
2. During test operation, never change the data of the elements which are used to perform significant operation for the system.
3. False output or malfunction can cause an accident.

# CATALOG

Chapter 1	Overview.....	1
I	MT series HMI.....	1
II	Function Instruction.....	1
III	Naming Rule.....	3
IV	Precaution.....	4
V	Parameters.....	5
VI	Hardware Specification.....	7
VII	Installation.....	12
Chapter 2	CoolMay HMI software.....	15
I	Installation.....	15
II	How to open CoolMayHMI.....	18
III	Run Menu.....	22
3.1	File.....	22
3.2	Edit (Quick Selection Tools) .....	27
3.3	View.....	30
3.4	Tool.....	39
3.5	Drawing Menu.....	45
3.6	Element Menu.....	46
3.7	Application.....	49
3.8	Debug Menu.....	58
3.9	Individuation Menu.....	63
3.10	Window.....	65
3.11	Help Window.....	67
Chapter 3	Element Function.....	69
I	How to select element.....	69
II	Text  .....	70
III	Register  .....	72
IV	Indicators  .....	76
V	Bit operation switch  .....	78
VI	Historical trend chart  .....	83
VII	Real-time trend chart  .....	89
VIII	Bar graph  .....	94
IX	Meter  .....	97

X	Picture		99
XI	GIF Animation Components		105
XII	Dynamic text		106
XIII	Function Key		109
XIV	Variable text		113
XV	Letter Combinations		115
XVI	Roll lamp		116
XVII	Polymorphic button component		118
XVIII	Multi-state indicator component		120
XIX	Date		122
XX	Time		124
XXI	SQL query component		125
XXII	SSliding block component		126
XXIII	Drop-down box component		128
XXIV	Dynamic alarm bar component		130
XXV	Historical data list		132
XXVI	Recipe		139
XXVII	Alarm record list		144
XXVIII	Real-time alarm list		150



XXIX	Memo		152
XXX	Audio playback component		156
XXXI	Rectangle		158
XXXII	Hollow rectangle		161
XXXIII	Convex Rectangle		163
XXXIV	Cross pipes		165
XXXV	Vertical pipes		167
XXXVI	Pipe joint		169
XXXVII	Scale		171
XXXVIII	Line		173
XXXIX	Ellipse		174
XL	Table component		176
XL1	Flow block component		178
XLII	Static text component		180
XLIII	Digital display component		181
XLIV	Handpiece component		183
XLV	XY trend component		185
XLVI	Sector chart component		187
XLVII	QR code component		189
Chapter 4	Macros		191

I	Macro Type.....	192
II	Editing of Macro.....	192
III	Operand of macros.....	197
IV	Errors.....	211
Chapter 5	System Control Area.....	212
I	Parameters.....	212
II	Network Setting.....	214
III	Other settings:.....	218
IV	Special Registers.....	228
1)	Internal Cache Area.....	228
2)	Read-only register code.....	229
Appendix	MT series supported PLC.....	236
I	Porcheson PS series.....	236
1)	Software setting.....	236
2)	Operational address.....	236
3)	MT( COM1 )-PS wiring :.....	236
II	MITSUBISHI FX Series.....	237
1)	Software setting.....	237
2)	Operational address.....	237
3)	MT( COM1 )-Mitsubishi Fx wiring.....	238
III	Omron C Series.....	238
1)	Software setting.....	238
2)	Operational address.....	239
3)	MT( COM1 )- Omron CPM/CQM wiring.....	239
IV	Siemens S7-200 Series.....	240
1)	Software setting (Need to customize the COM1 port to 485 port).....	240
2)	Operational address.....	240
3)	MT( COM 2)- Siemens S7-200 wiring.....	240

## Chapter 1 Overview

### I MT series HMI

Thank you for choosing Coolmay HMI. Read this manual and make sure you understand the functions and performance of Coolmay HMI thoroughly in advance to ensure correct use.

### II Function Instruction

#### ■ Supported PLCs

We support the following manufactures, Mitsubishi. Omron. Panasonic. Siemens. ModBus RTU. ModBus ASCII. ModBus TCP. LG. Delta. Fatek. Vigor and so on. As for new brands, we will supply relevant communication protocol for updating.( The brands referred above are reserved by the relevant manufactures)

#### ■ Convenient operation and macro instructions

By operating macros can help PLC to deal with complicated computation, together with the communication macro, users can draft the communication protocol by themselves and then the element can communicate with certain system through COM port.

#### ■ Quickly download program via USB

Download via USB Ver1.1/2.0 will shorten the download time

#### ■ Two PLCs supported simultaneous

Two COM ports can be supported simultaneously. Two controllers no matter with the same communication protocol or not can be connected simultaneously.

- Off-line simulation

Off-line simulation: Simulate project operation on PC without any connection.

- on-line simulation

On-line simulation: Simulate project operation on PC and PLCs are directly connected with PC.

- Ethernet communication port (Only some MT60 series touch screens are available for optional)

10/100BASE-T ethernet communicate port provide fast data exchange function. Any TP can organize network to perform aggregate remote control.

- Backup data by U disk (U disk file system must be FAT 32) or SD card (only MT60 series HMI support)

The data uploading and downloading function can be realized through the U disk or the SD card; the HMI program compiled on the computer can also be downloaded to the touch screen through the U disk or the SD card, so that HMI is not connected to the PC, and the program is downloaded using the HMI software. The historical data and alarm messages can be transferred to SD card. The user can use card reader to read the messages.

- Multiple security

Provide password protection to protect the intellectual property of programmer. Provide password protection of using element of screen. The element can be used only when user's privilege level is higher than the status of the element.

### III Naming Rule

#### 1. MT60xx series

MT6 070 H - W - Y

① ② ③ ④ ⑤

#### 2. MT90series

MT9 070 KH

① ② ③

①MT6: MT60series HMI

①MT9: MT90 series HMI

Series	Model	Pixels
MT60XX	MT6150HA	1024*768
	MT6100HA/MT6070HA	1024*600
	MT6070H(AS)/MT6050H(A)	800*480
	MT6043H(A)	480*272
	MT6037H	320*240
MT90XX	MT9070KH/MT9050KH	800*480
	MT9043KH	480*272
	MT9037H	320*240

②LCD Size:

037: 3.5"

043: 4.3"

050: 5.0"

070: 7.0"

100: 10.2"

150: 15"

③H:standard horizontal,

HV:standard vertical,

HA/HAS:upgraded horizontal,

HAV/HAVS:upgraded vertical.

④W: Ethernet port (optional)

⑤Y: Audio port (optional)

#### **IV Precaution**

##### **■ Operation environment**

When the operation temperature is among -20~70°C and the humidity is among 10%~90%RH, the brightness and the contrast ratio can be adjusted to provide users the best image. If beyond the range, long-time normal display not guaranteed.













##### **■ Random insertion prohibited**







COM port is prohibited to plug during running time. Please turn off the power supply while connecting or removing the communication cables.

##### **■ Top choice of equip**

Computers with PIII above 500, storage above 128MB, Windows XP/Windows 7/Windows 8/Windows 10 adopted.

## V Parameters

Model		MT6037H	MT6043H	MT6050H	MT6070H	MT6100HA	MT6150HA	
Image	Front							
	Rear							
Specs	Dimension	88*88*25mm	134*102*30mm	146*88*25mm	212*148*40mm	275*194*36mm	365*290*36mm	
	Cutout size	72*72mm	119*93mm	135*72mm	194*138mm	261*180mm	350*280mm	
	Display size	73*56mm	97*56mm	108*65mm	194*138mm	222*125mm	304*228mm	
	Weight(kg)	About 0.3 kg	About 0.33 kg	About 0.33 kg	About 0.54 kg	About 0.7 kg	About 3.414 kg	
Display	Display	3.5" TFT	4.3" TFT	5" TFT	7" TFT	10.1" TFT	15.0" TFT	
	Resolution(pixels)	320*240	480*272	800*480	800*480	1024*600	1024*768	
	Brightness	300cd/m <sup>2</sup>					450cd/m <sup>2</sup>	
	Contrast ratio	400:1						
	Backlight	LED						
	Backlight time	60,000 h						
	Display color	65536 true colors						
Touch type	4-wire resistive panel							
Storage	ROM	128MB						
	RAM	64MB				128MB		
	CPU	ARM9 core 400MHz				CORTEX A8 720MHz-1GHz		
Operating system	WINCE 5.0					WINCE 7.0		
Interface	USB Host	USB 2.0×1 (USB port and can be connected to external USB flash drive, mouse, etc.)						
	USB DEVICE	Yes (Mini type B male port cable for program download)			Yes (Type B male port cable for program download)			
	Ethernet port	Optional						
	COM port	1 RS232 and 1 RS485						
	Protocol	Support MODBUS, free port and common PLC communication Protocol						
Calendar	Yes							
Input Voltage	Default as DC24±10%V, and DC12V/DC5V can be optional							
Consumption	100mA*24V	150mA*24V	150mA*24V	200mA*24V	280mA*24V	500mA*24V		
Protection Class	IP65 (front panel)							
Temperature	Ambient environment: 0~50℃   Storage environment: -20~70℃							
Humidity	20%~90% RH							
Certification	CE							
Software	CoolMay HMI programming software Detailed info. refer to <a href="#">CoolMay HMI user manual</a> , <a href="#">CoolMay HMI programming manual</a>							

Model		MT9037H	MT9043(50)KH	MT9070KH
Image	Front			
	Back			
Regulation	Dimension	88*88*25mm	150*93*32mm	226*163*35.6mm
	Cutout size	72*72mm	143*86mm	217*154mm
	Display size	73*56mm	97*56mm	154*87mm
	Weight	about 0.3 kg	about 0.33 kg	about 0.7 kg
Display	Display	3.5" TFT	MT9043KH: 4.3" TFT MT9050KH: 5.0" TFT	7" TFT
	Resolution (pixels)	320*240	MT9043KH: 480*272 MT9050KH: 800*480	800*480
	Brightness	300cd/m <sup>2</sup>		
	Contrast ratio	400:1		
	Backlight	LED		
	Backlight life	60,000 hours		
	Display color	65536 true colors		
	Touch type	4-wire resistance panel		
storage	ROM	128MB		
	RAM	32MB	64MB	
	CPU	ARM9 core 216MHz		ARM9 core 288MHz
Operating system		Null		
COM port	USB DEVICE	Yes (Mini type B male port cable for program download)		Yes (Type B male port cable for program download)
	COM port	1 RS232 and 1 RS485		
	CAN port	NULL	CAN 2.0B is optional	
	Protocol	Support MODBUS, free port and common PLC communication Protocol		
Calendar		Yes		
Output voltage		DC5V~DC24V		
Consumption		< 3W	< 8W	
Protection class		IP65 (front panel)		
Temperature		Ambient environment: 0~50℃   Storage environment: -20~70℃		
Humidity		20%~90% RH		
HMI software		<a href="#">CoolMay HMI Programming Software</a> Detailed info. refer to <a href="#">CoolMay HMI User Manual</a> , <a href="#">CoolMay HMI programming manual</a>		



## VI Hardware Specification

MT6037H



Black panel  
(Black back case)



Silver brushed panel  
(Black back case)

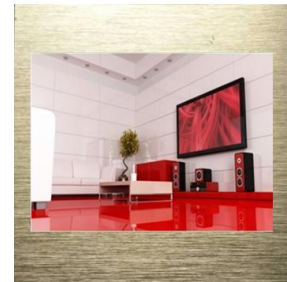

Golden brushed panel  
(White back case)

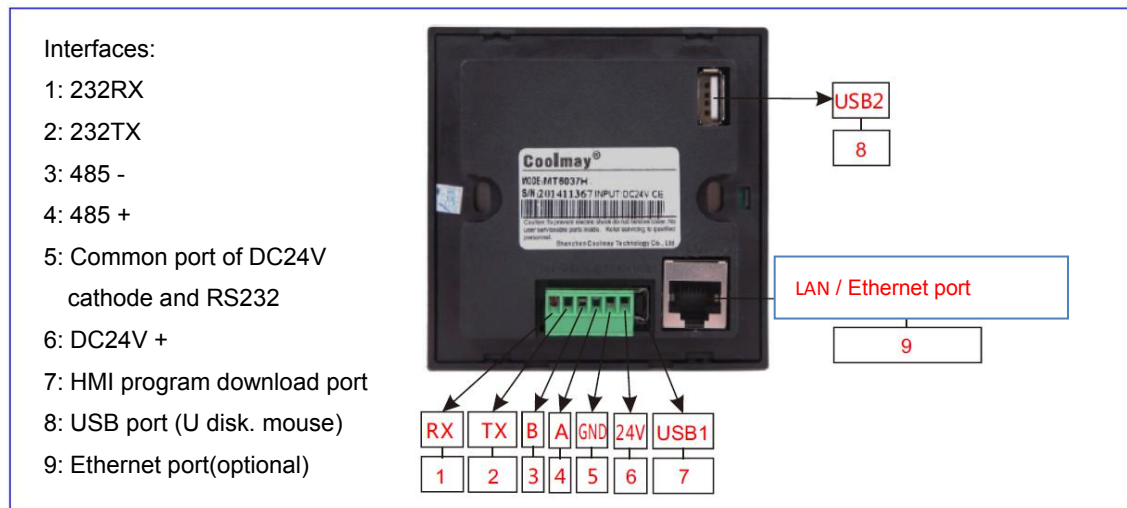

black back case

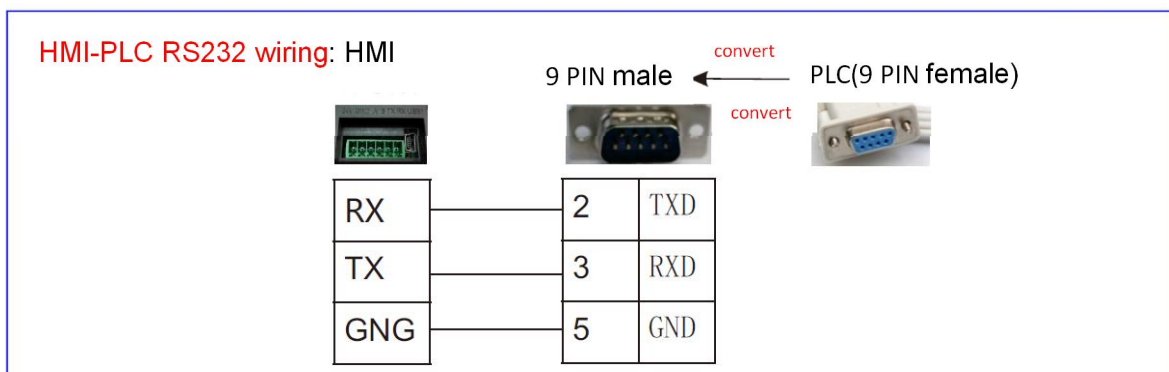

MT6043H



Gray panel

**Interface definition:**

1. GND
2. DC24V-
3. DC24V+
4. LAN(Optional)
5. Rs232/485
6. USB HOST(U disk, mouse)
7. HMI programming download port

FG	0V	DC 24	LAN(网口选择)	COM1/COM2	USB HOST	USB DEVICE
1	2	3	4	5	6	7

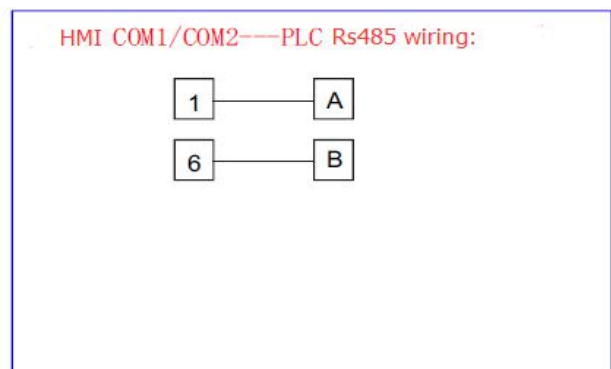
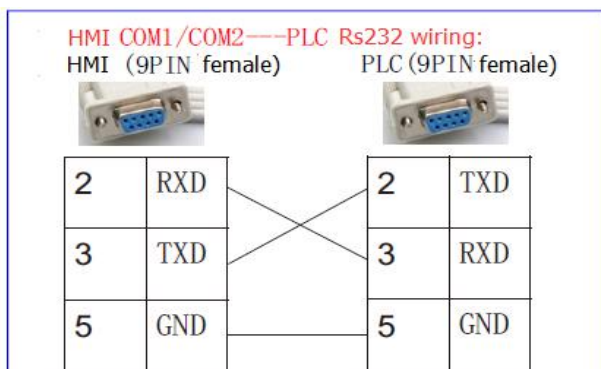

MT6050H



Black panel (black back case)



Silver brushed panel(black back case)



Golden brushed panel (White back case)

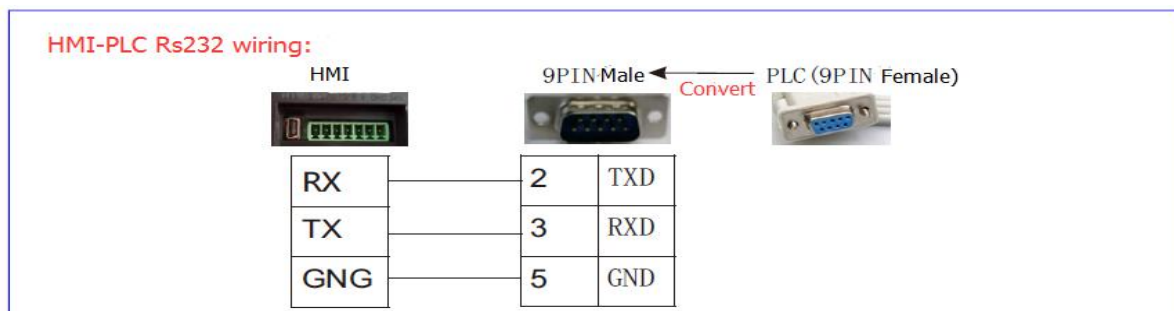
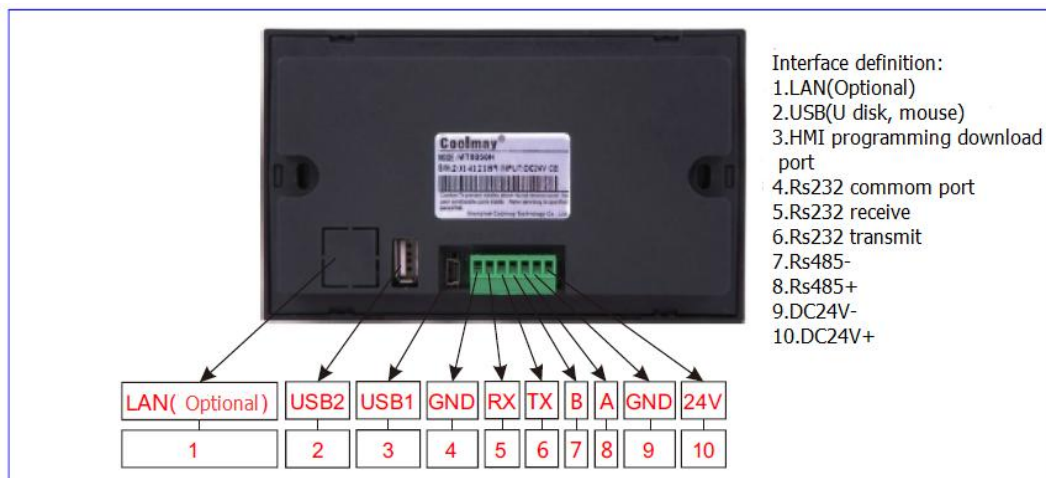

MT6070H



Gray panel



Interface definition:

1. Frame ground
2. DC24V-
3. DC24V+
4. LAN(Optional)
5. Rs232/Rs485
6. HMI programming download port
7. USB host

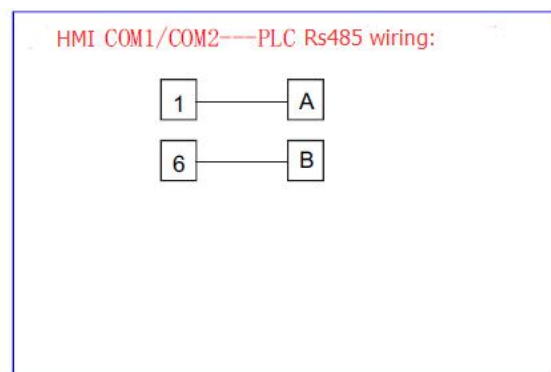
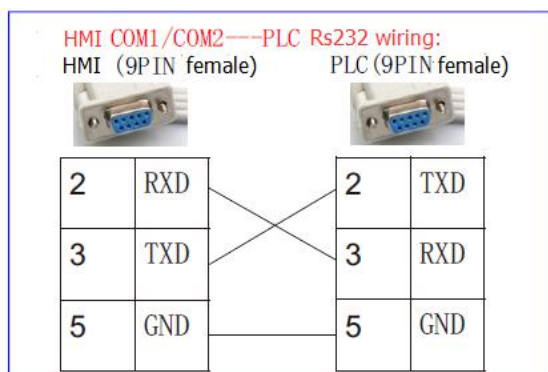

MT6100HA

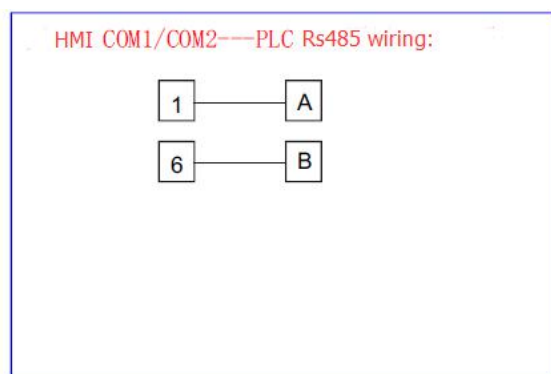
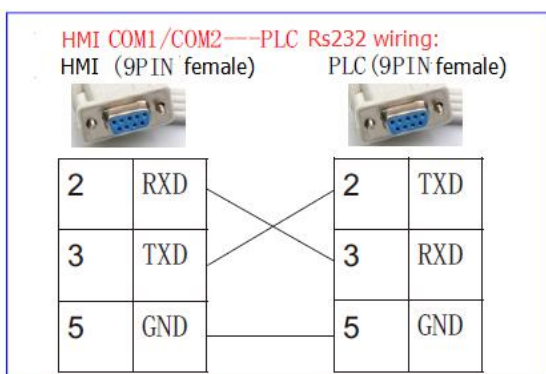
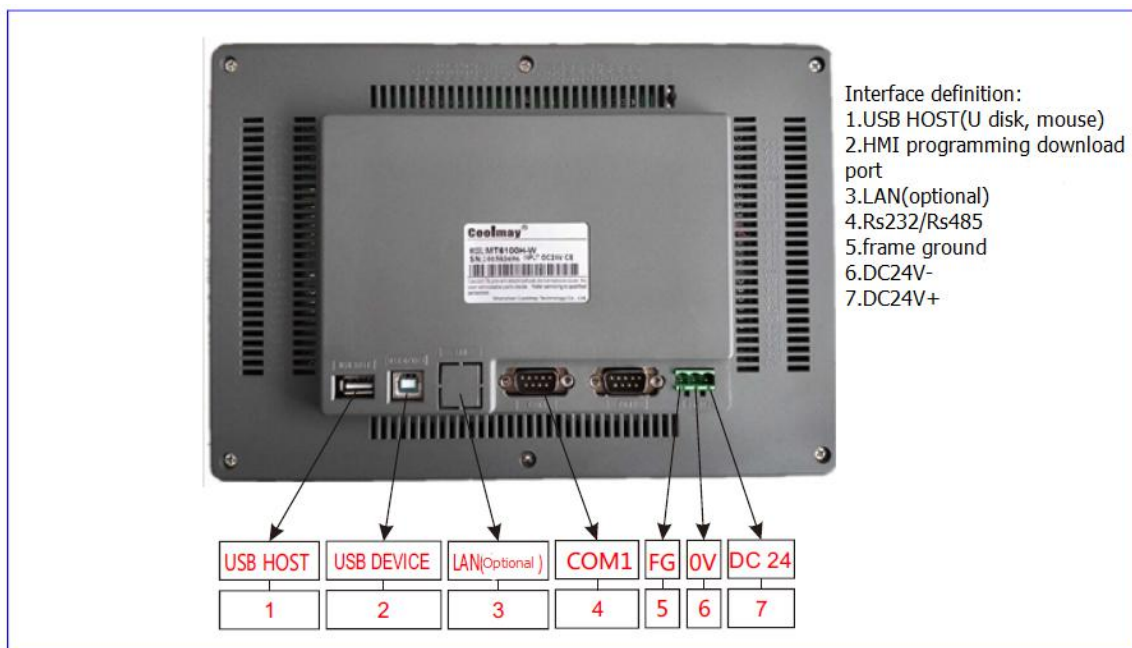



**VII Installation**

**Dimensional drawing (MT6037H)**

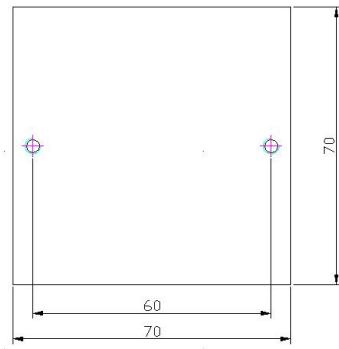

Wall Installation

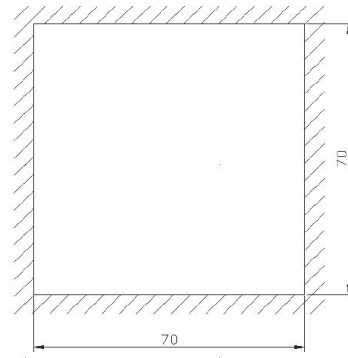

Inlaying Installation

**Dimensional drawing (MT6043H)**

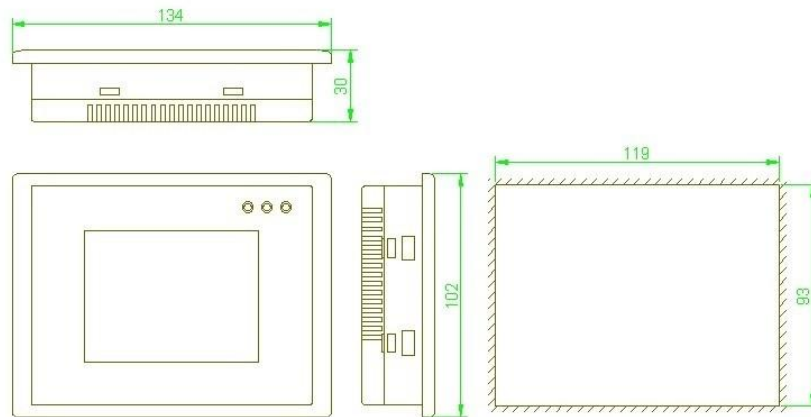

**Dimensional drawing (MT6050H)**

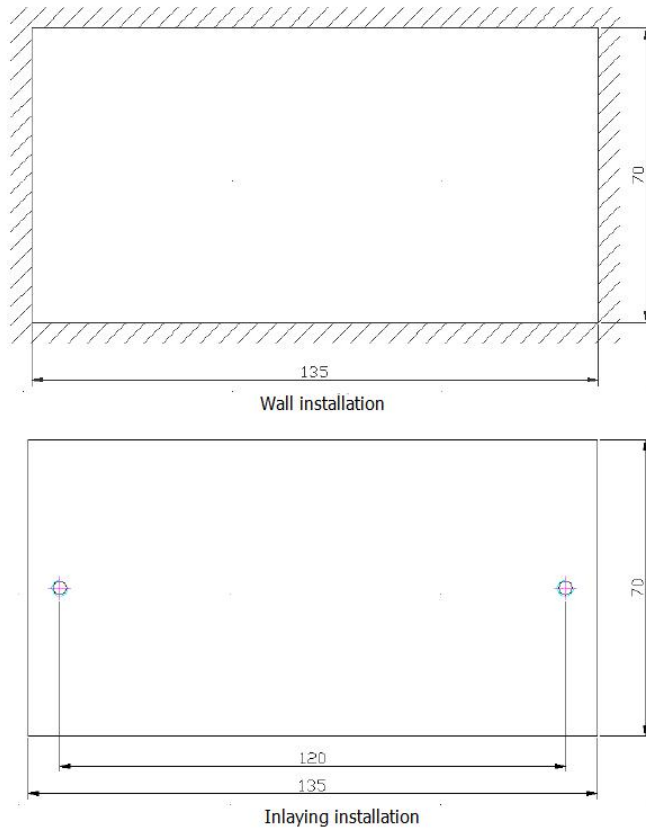

**Dimensional drawing (MT6070H)**

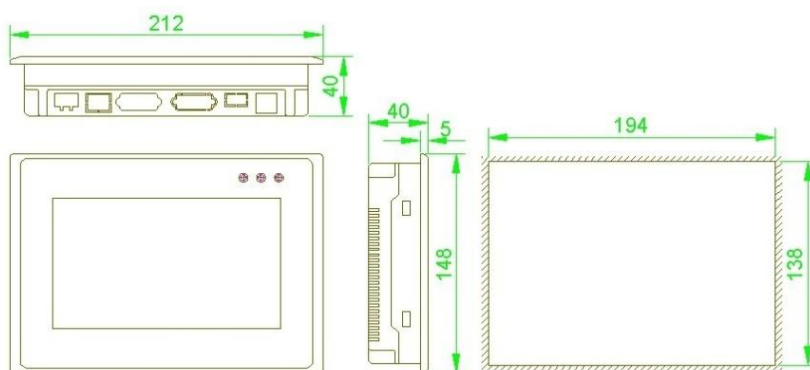

**Dimensional drawing (MT6100HA)**

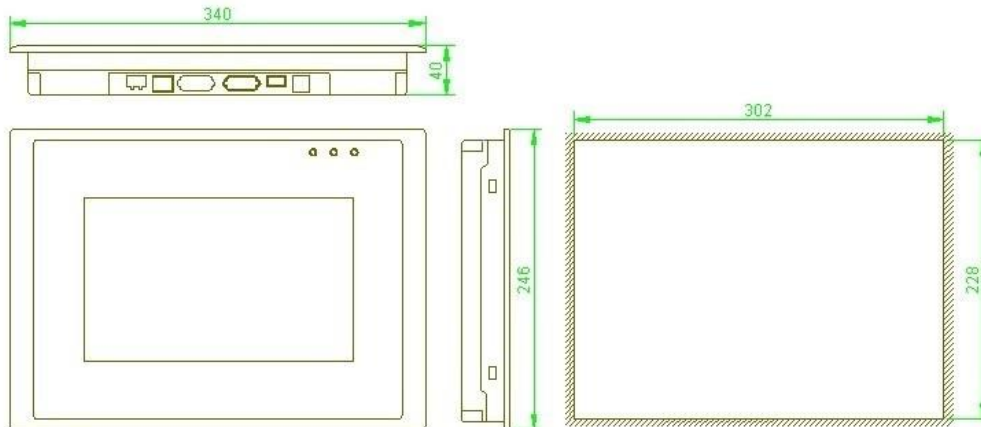

**Installation Fastening**

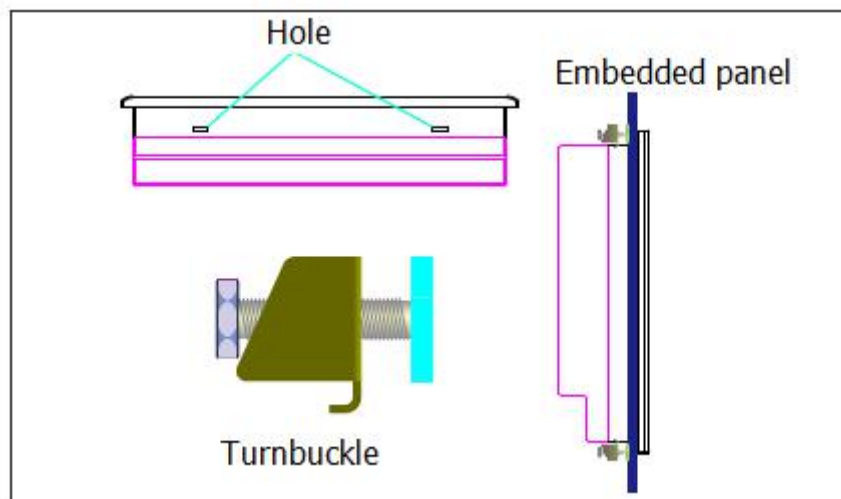



## Chapter 2 CoolMay HMI software

### I Installation

(please download the latest version from the official website  
[www.coolmayplc.com](http://www.coolmayplc.com))

This chapter introduces how to install Coolmay HMI software and screen editing, users can design working frame they want. Detailed explains will be listed in the later chapters.

#### ■ Hardware (recommended)

1. PC host: CPU 80486 or higher
2. Memory: 128MB or higher RAM
3. Hard disk: Disc space available at least 100MB
4. Display: VGA or SVGA
5. Mouse: Compatible with Windows
6. Printer: Compatible with Windows
7. System: XP / Win7 / Win8 / Win10

#### ■ Software source

Download from the website [www.coolmayplc.com](http://www.coolmayplc.com)

#### ■Steps to Install CoolMayHMI V\*.\*\*.

Note: the software version is subject to the official website.

- Select [CoolMayHMI V\*.\*\*] in the installer window, start the installation program
- Click [Next] in the welcome window

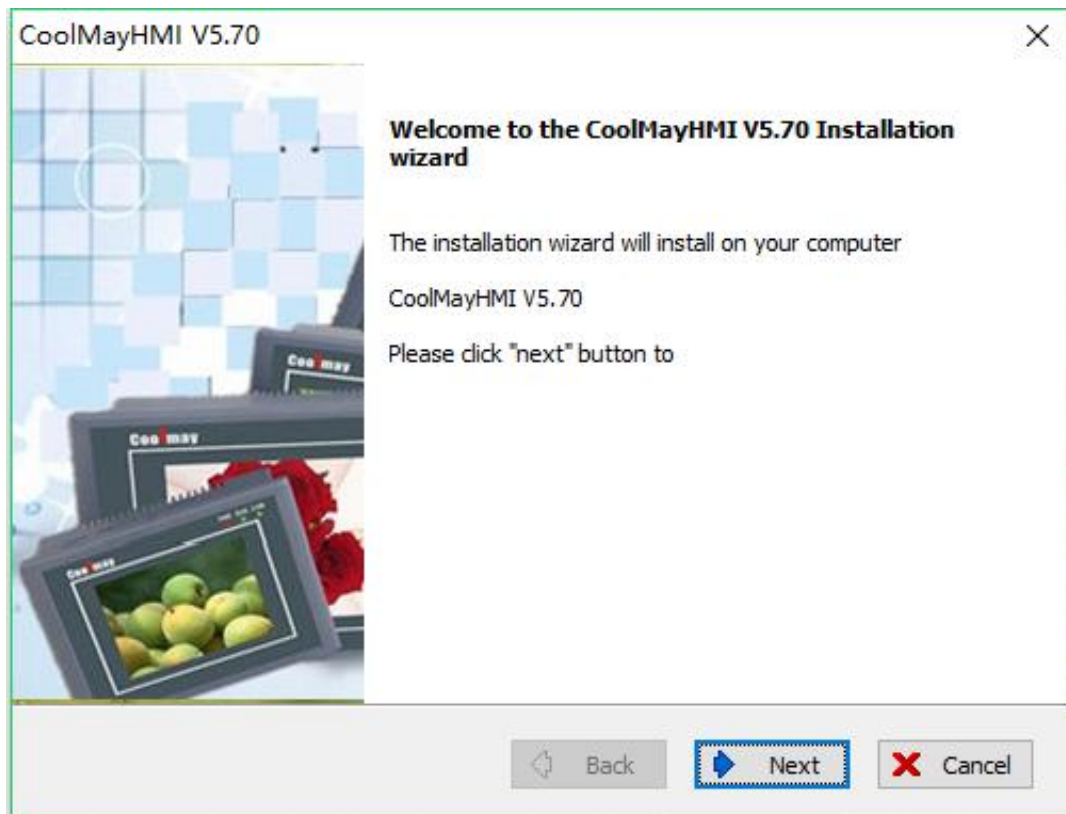

- Select a folder for installation, or use the default folder. Click [Next].

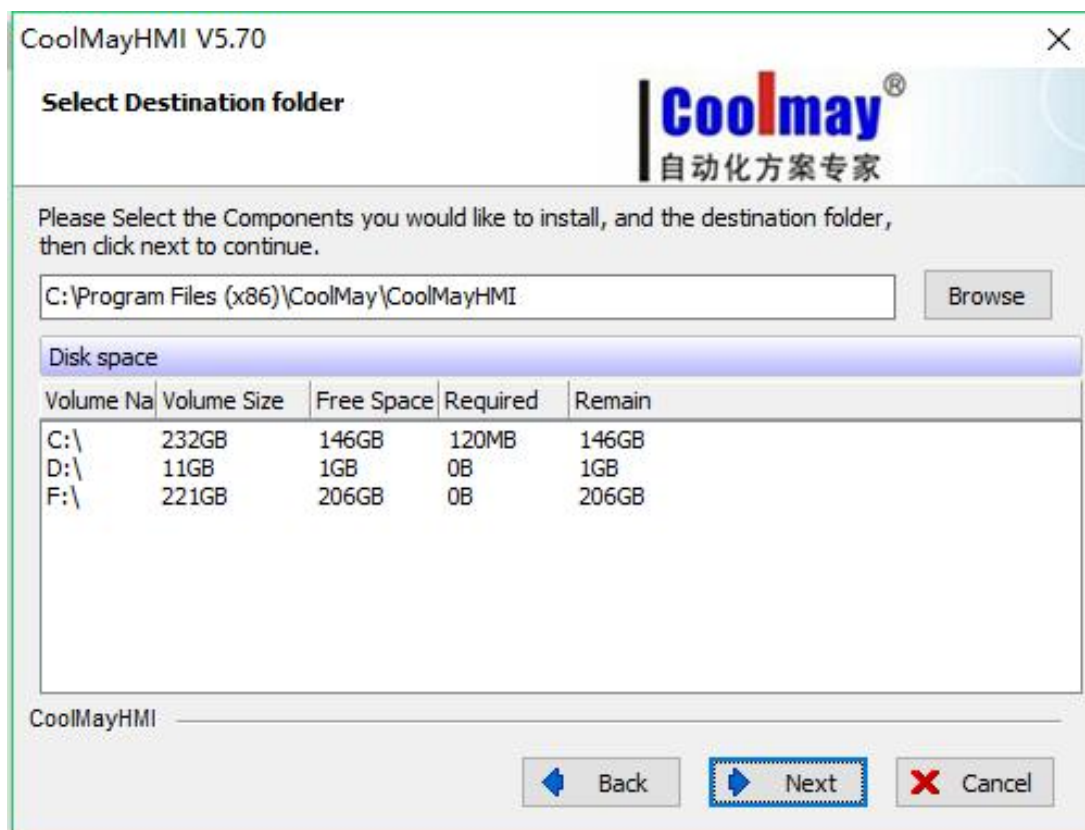

- Click [Next] to start installation.



- Installation progress

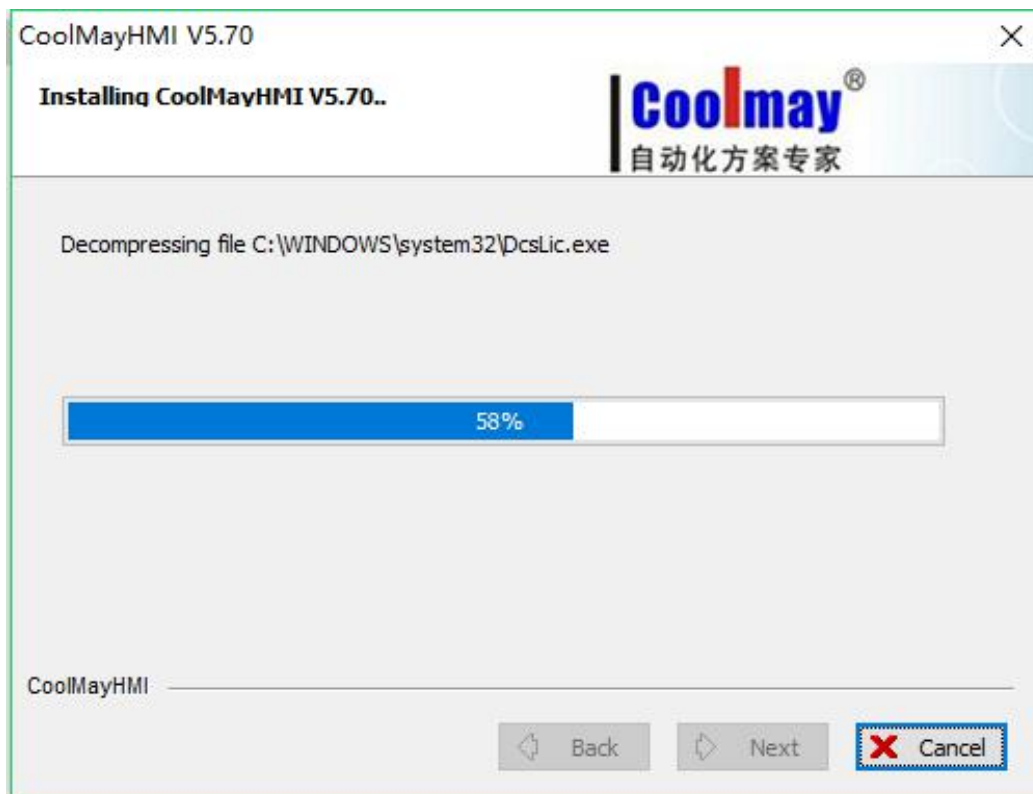

- Click [EXIT] to exit the installation wizard.

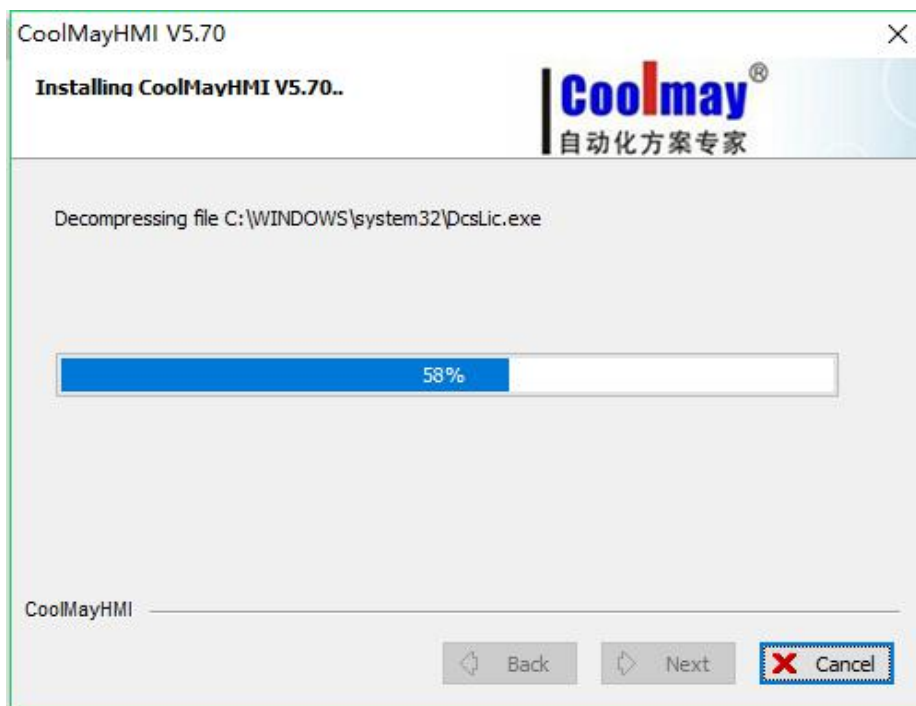

## II How to open CoolMayHMI

After installing CoolMayHMI , the shortcut icon



will be shown in the desktop.

Meantimes, The corresponding CoolMayHMI program group has also been added to the Windows Start menu:

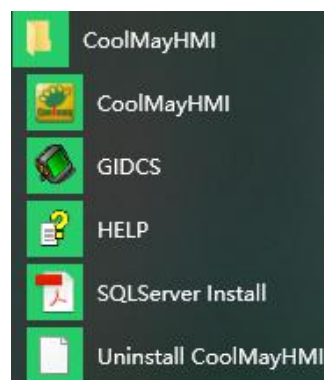

Win8 System:

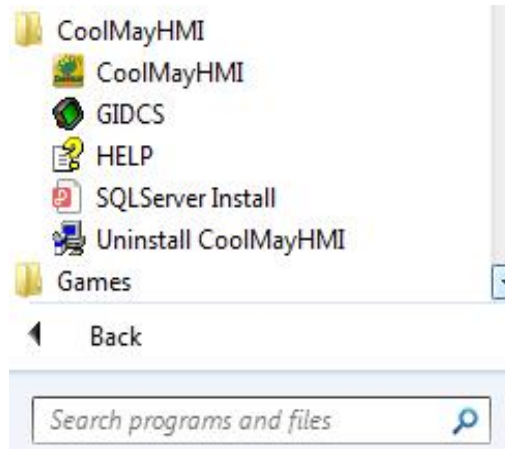

win7 System:

Take [Open examples] as an example: any of the above methods can run the configuration software. The welcome window will pop up when you start CoolMay HMI:

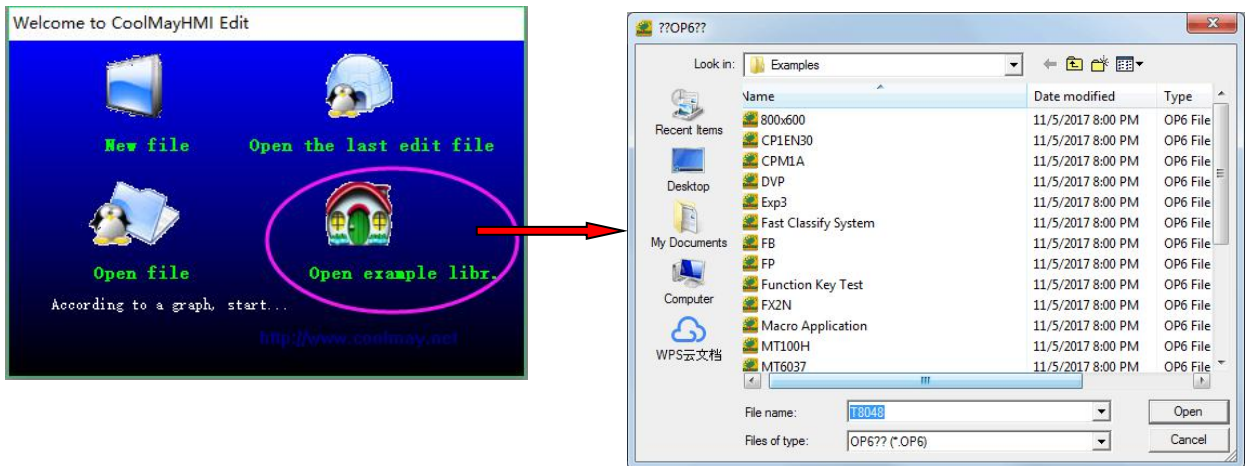

Click [Open examples ] ,Exp3.OP6 ->the interface is as follows:

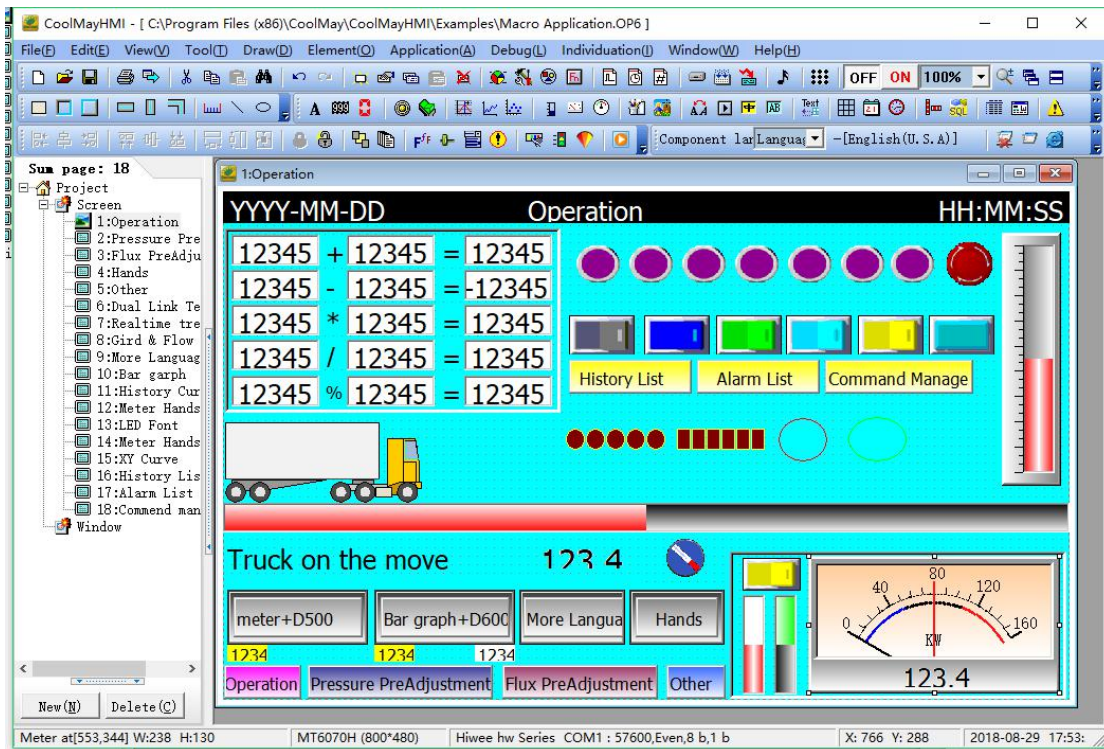



## CoolMayHMI editing interface layout

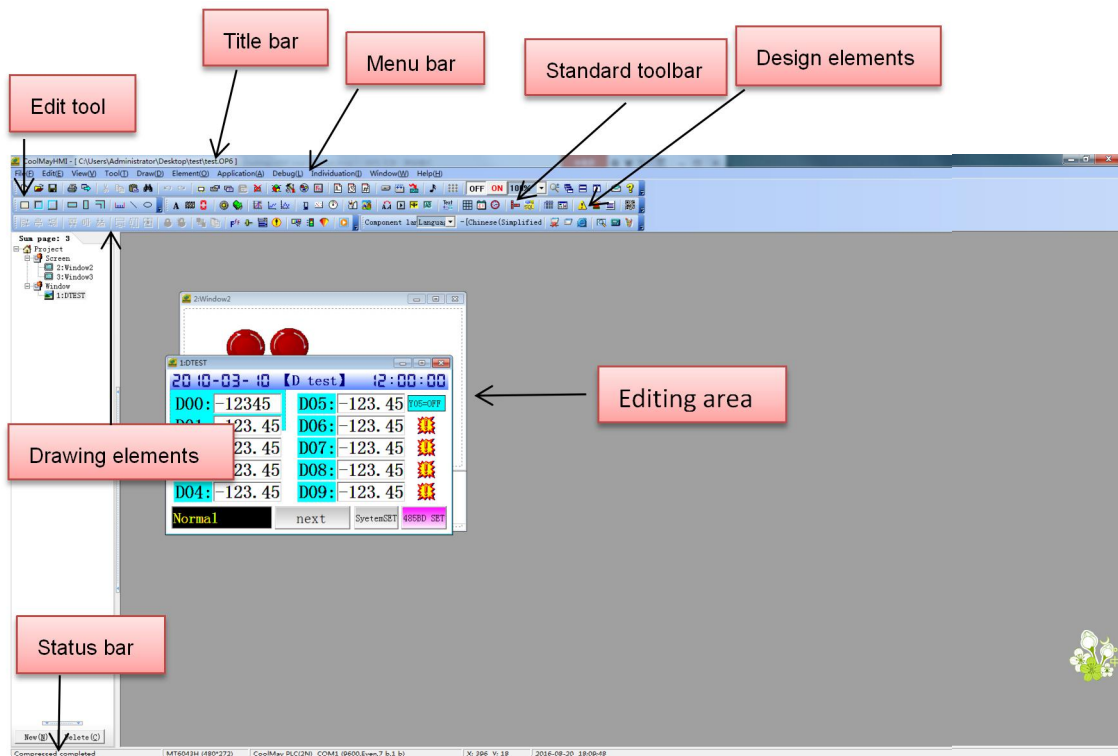

- Title bar: display the present route. file name. window number and name.
- Menu bar: display menus of every command and these menus are all dropdown menus.
- Standard toolbar: lay shortcut icons of commands. [Display file], [edite],[print] etc.
- Design elements: command button for element element
- Drawing element: command button for graphing elements
- Edit tool: command button for editing elements
- Image management: window of image management
- Screen editing area: windows for editing graphic elements
- Status bar: display the current state, HMI parameter, communication element

### III Run Menu

File(F) Edit(E) View(V) Tool(T) Draw(D) Element(O) Application(A) Debug(L) Individuation(I) Window(W) Help(H)

#### 3.1 File

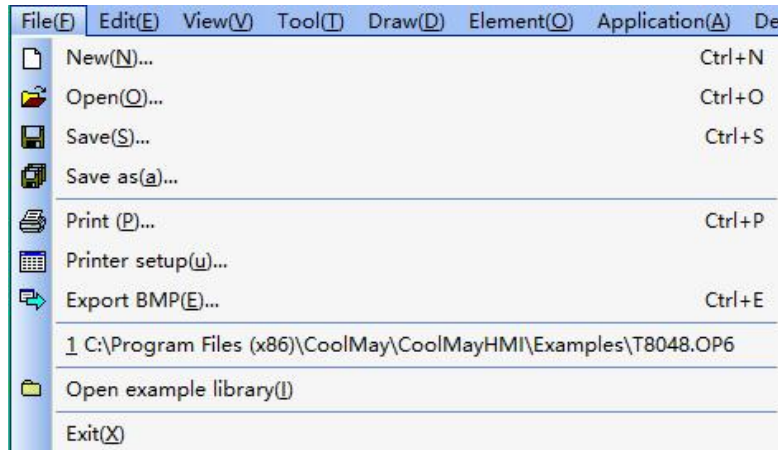

#### 1) Create a new project file

Click [New], or click the icon  in the toolbar, or use the defaulted hotkey **Ctrl+N**.

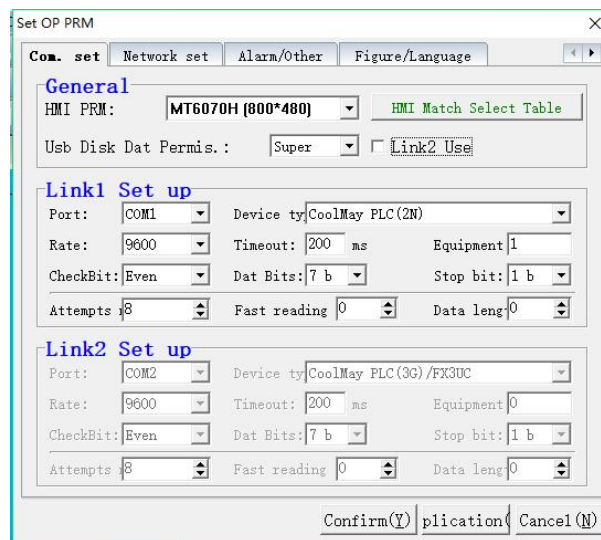

Set HMI parameters, Link1/Link2 COM port and PLC model, then click [Confirm].



## 2) Open a project

Open an existed project, click [Open] in [File] dialog box, or click  in the toolbar, or use the hotkey “Ctrl+O”.

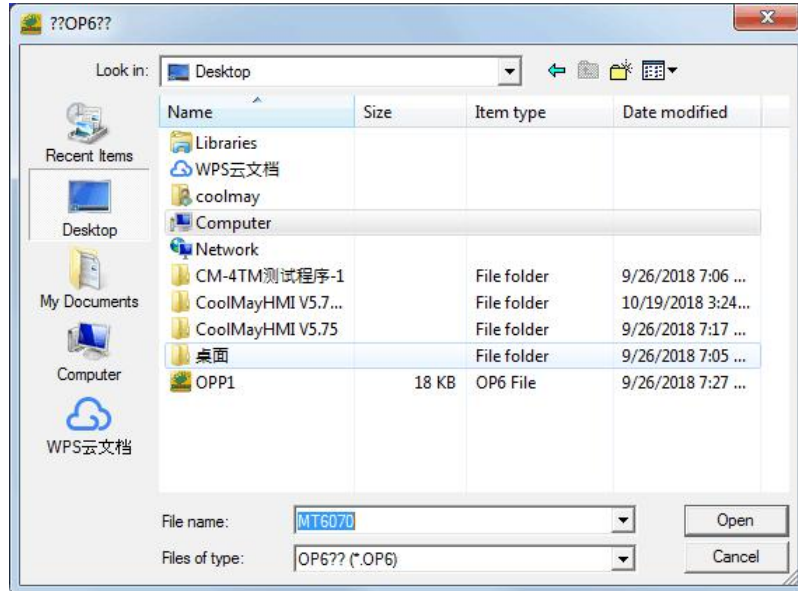

Select the project file , click [Open] or double click the file.

## 3) Save a project file

Click [Save] or the icon  in the toolbar, or use the default hotkey **Ctrl+S**.

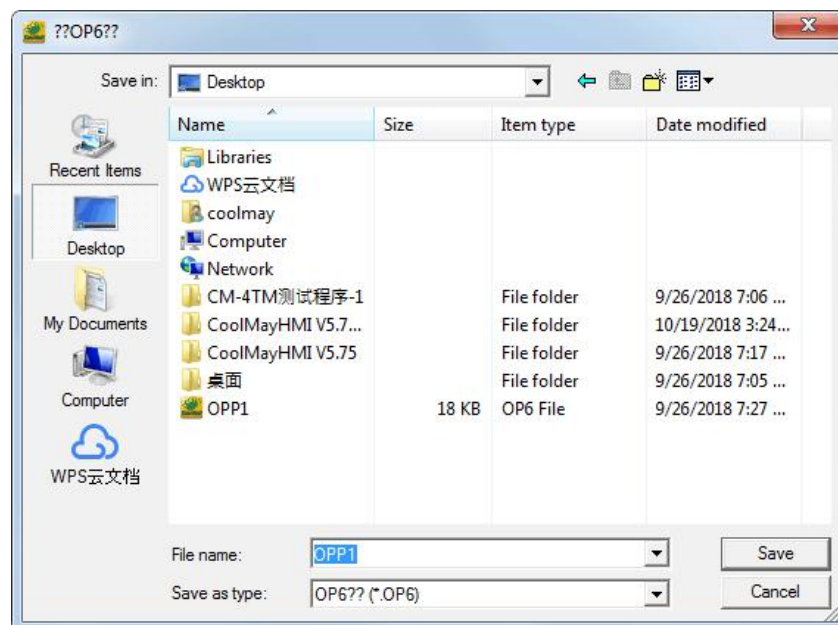

When save a new project file, the save window pop up, entry the file name and

click[save]. If the project file has been saved, no window pop up after click [save], just the latest information of the project file is saved then.

#### 4) Save as a new project file

Click [Save as] in [File] dialog box, [Save as a new file] dialog box will pop up no matter the file is a new one or an old one.

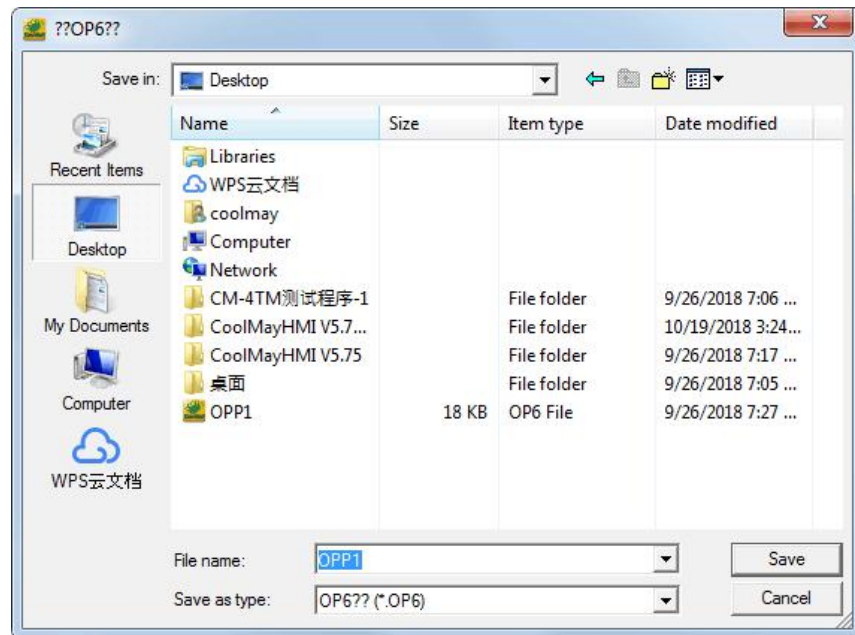

After entering the new file name, click[Save], then the file is saved as a new project file.

## 5) Printer

Click [Print] or the icon  in the toolbar, or use the defaulted hotkey **Ctrl+P**.

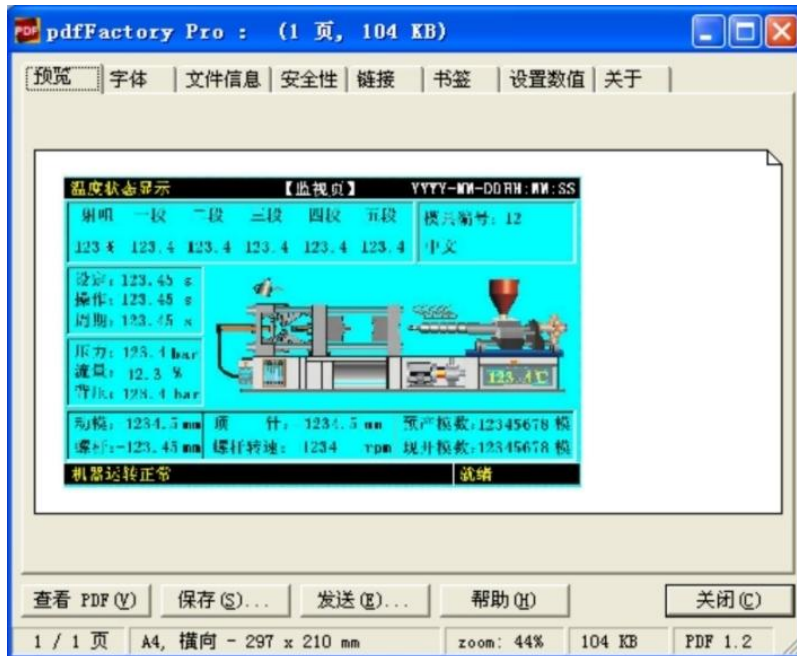

## 6) Printer settings

Select [Printer Settings] in the menu to open the following dialog box, then select a printer and set the parameters.

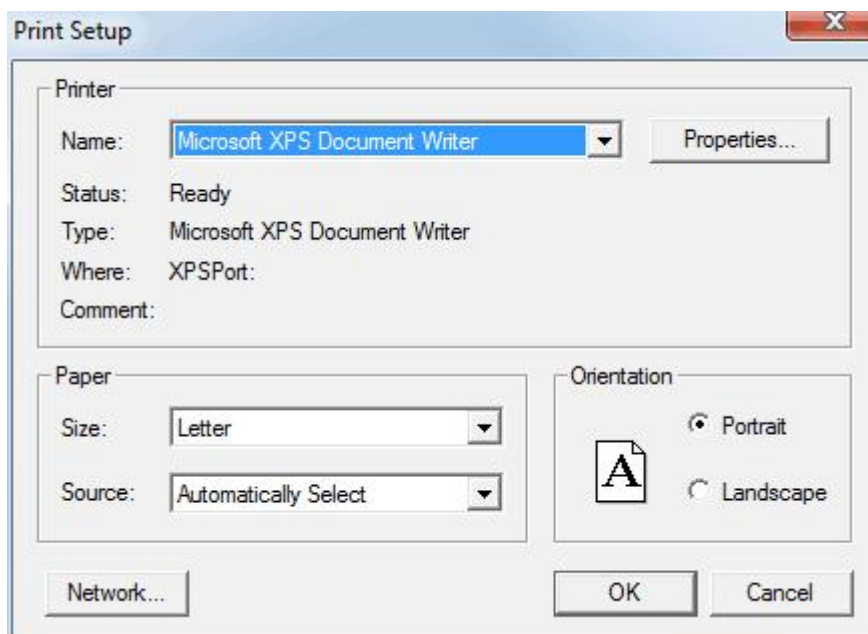

You can select a different printer connected to your computer by clicking the drop-down box next to the printer name.

## 7) Export Picture

Store the current screen in the disk with BMP form, select [Picture Export] in [File] dialog box or click  in the toolbar, or the defaulted hotkey **Ctrl+ E**.

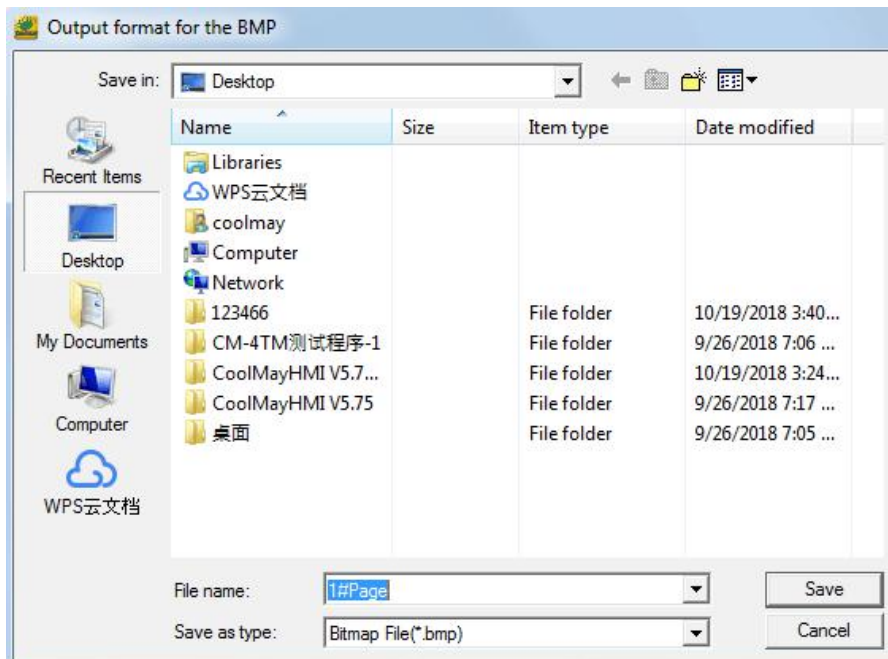

## 8) Route of project used recently

Recently accessed project path: Here is the most recently used project path, click to open the selected project project quickly.

## 9) Exit

Select [Exit] in the [File] dialog box, or click [Close] in the main window, if the project file has been updated or hasn't been stored, then the following dialog pops up:

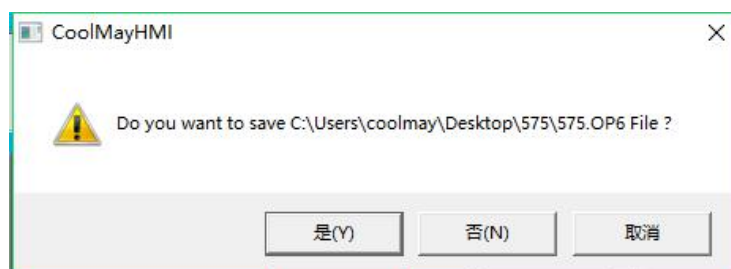

Click [Cancel], the project file won't be end. click [Yes] or [No], the project file will be closed later. If it is a new project file, the dialog of [Save as another new file] will be open, click [Save] or [Cancel], the program will be closed.

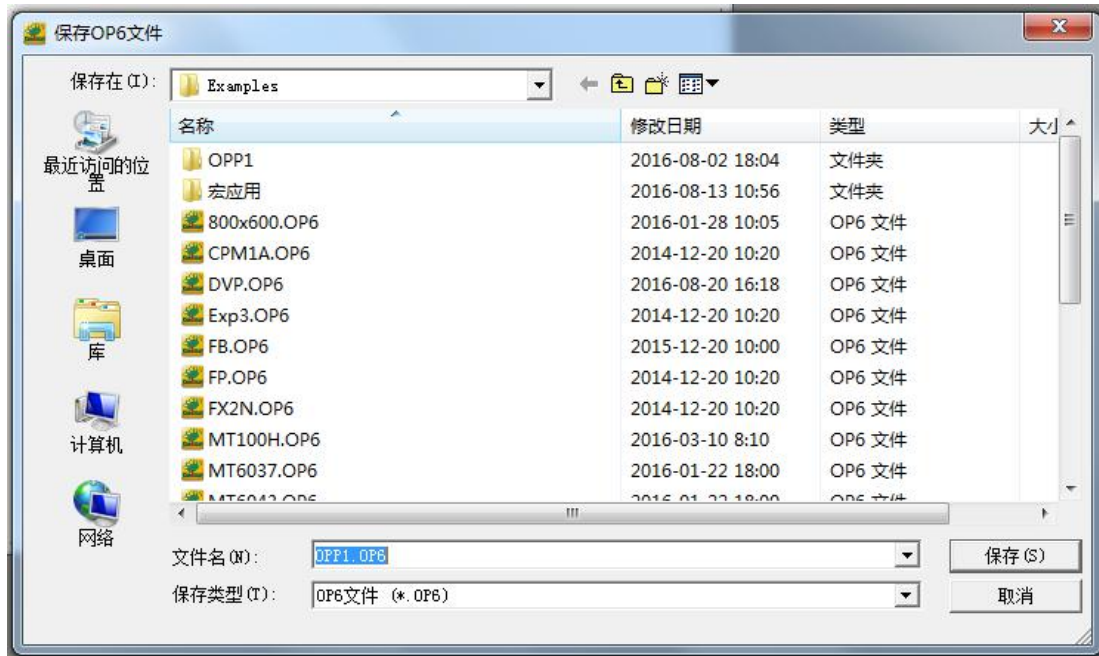

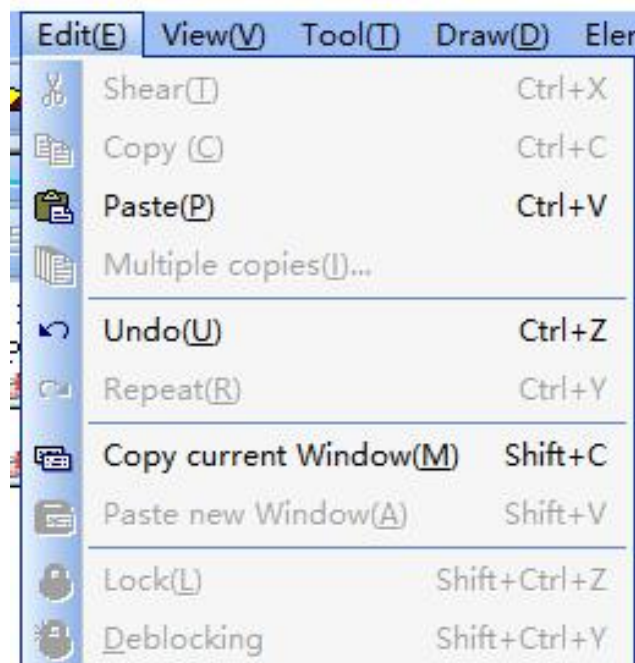

### 3.2 Edit (Quick Selection Tools)



- 1) Shear Relocates the selected items to the clipboard, or click .

Hotkey: **Ctrl+X**

- 2) Copy Copies the selected items to the clipboard or click . Hotkey: **Ctrl+C**
- 3) Paste Pastes the items in the clipboard at the selected location or click . Hotkey: **Ctrl+Z**
- 4) Multiple copy

Select a certain element to operate multiple duplication. The below dialog box will pop up.

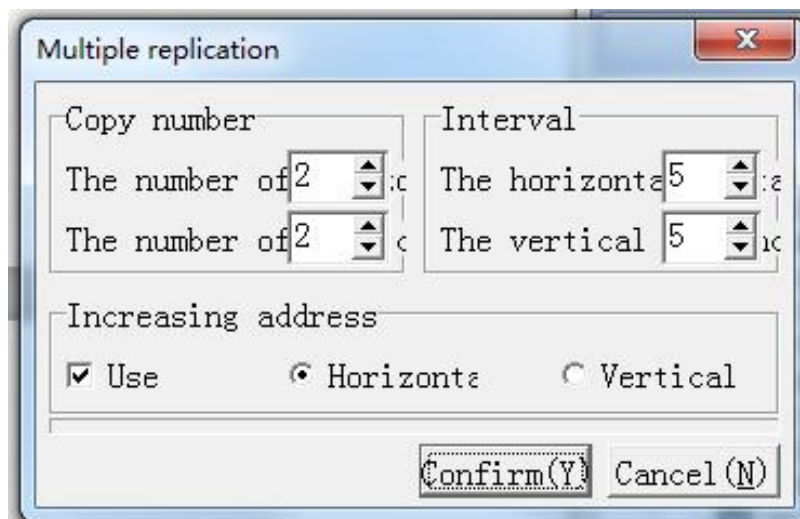

Set [Quantity in horizontal] and [Quantity in vertical], click [Confirm], get the module with the quantity of X\*Y. Since the module itself is concluded in the matrix, the minimum quantity is 1. The interval is the same with the interval of elements. The new element will be auto separated after enter in and being duplicated. Incremental address is progressive increased horizontally or vertically as stated. If the unit is word, it will increase with the unit of word. If the unit is bit, it will increase with the unit of bit.



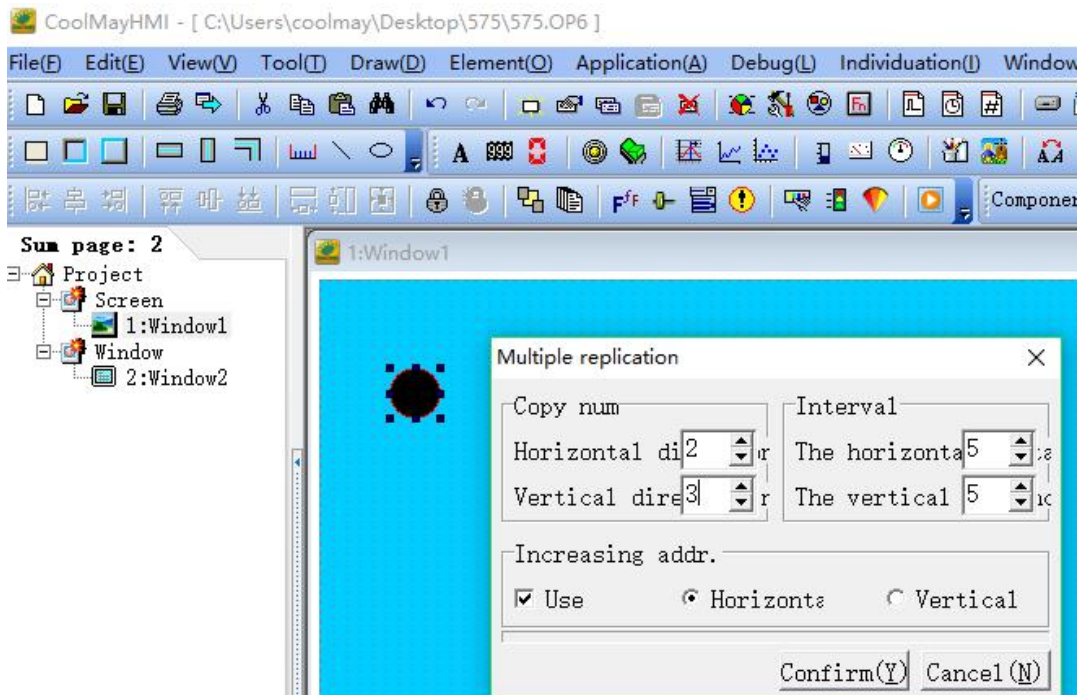

Example: quantity in horizontal=2, quantity in horizontal=2

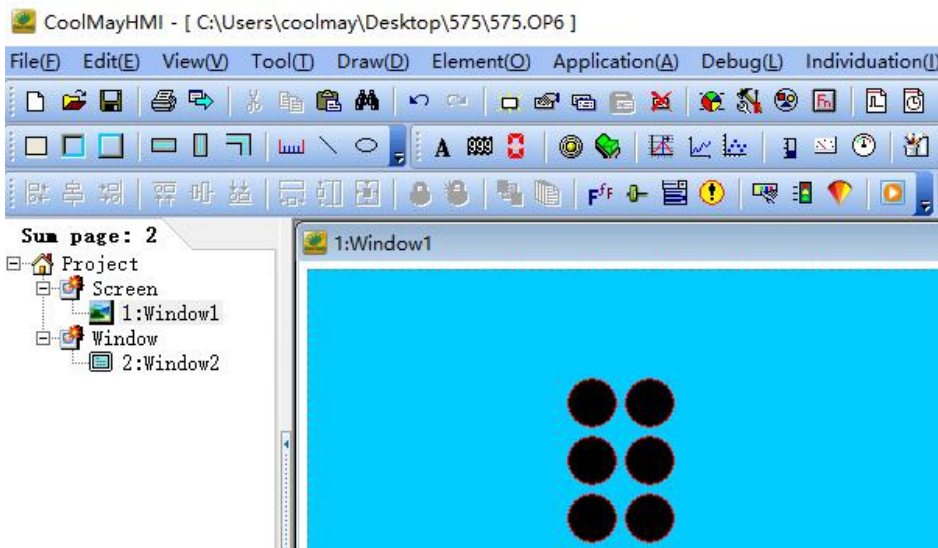

Example: Click [Confirm] to complete.



- 5) Undo Return to the last operation or click . Hotkey: **Ctrl+Z**
- 6) Repeat Repeat the last cancel operation or click . Hotkey: **Ctrl+Y**
- 7) Copy current Window

Copy the whole picture. If you click the picture on it at this time, the original picture will be pasted, similar to the copy of the text editing. The only difference

is the whole picture. You can select the [Copy current picture] option under

[Edit]. , or click the  . Hotkey **Shift+ C**.

8) Paste new window

Paste new screen image or click  Hotkey: **shift+ V**

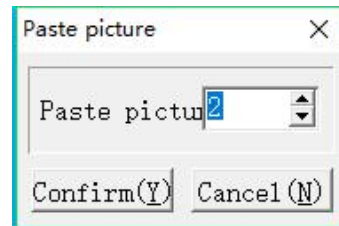

All the settings will remain the same, only the name will be assigned automatically.

9) Lock Lock the parts to prevent the layout from being moved and accidentally move the layout. You can select the [Lock] option under [Edit] or click  . Hotkey: **Shift + Ctrl + Z**

10) Deblocking Deblock the locked elements or click  . Hotkey: **Shift + Ctrl + Y**

### 3.3 View

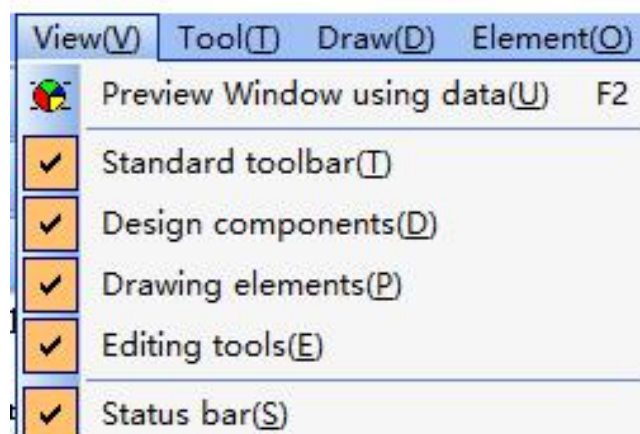

#### 1) Preview Window using data

Display the data distribution of the screen which is used. Select [Preview





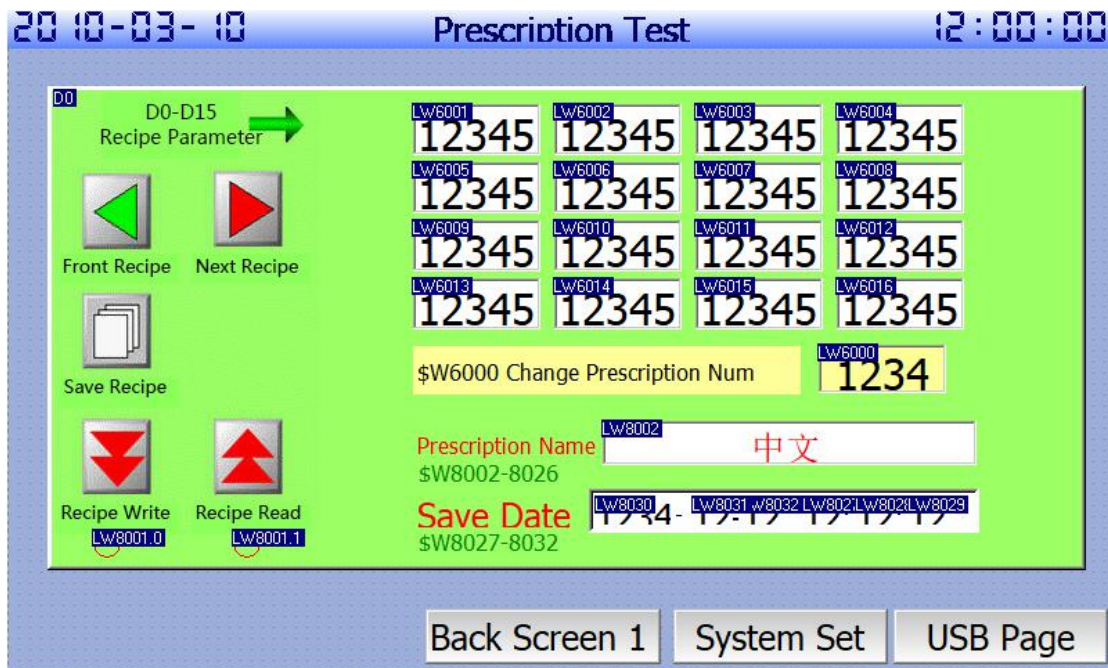



Window using data], or click the icon  in the toolbar. Hotkey: F2



































## 2) Standard Toolbar



Select whether display standard toolbar or not, see below figure:

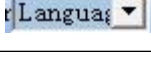

Icon	Name	function
	New	Opens a new project file
	Open	Opens an existing project file
	Save	Save an project file
	print	Send the current project file to the printer
	Export BMP	Save the selected screen in the disk with image form(BMP)
	Cut	Relocates the selected items to the clipboard.

	Copy	Copies the selected items to the clipboard.
	Paste	Pastes the items in the clipboard at the selected location.
	undo	Turn back to the last operation
	repeat	Repeat the last operation
	Create new window	Create a new screen
	Modify the picture properties	Modify the screen attribute
	Copy current window	Copy the current current screen image
	Paste new window	Paste the screen image which is copied or cut.
	Delete	Deletes the selected screen image
	Preview window using data	Display the distribution condition of data used by the screen
	Set OP series	Set operation parameters of OP
	Bulk edit	Bulk modify all attributes of projects
	Set keyboard parameters	Set keyboard parameters
	Initial	Initial
	Clock	Clock
	Sub	Sub

	Target file path	Set login path of target file
	Compile	Compile a project
	download	Download project data via Ethernet in short time.
	Grid	Select whether to display the grids
	OFF	Bit unit means OFF
	ON	Bit unit means ON
	Preview scale	Select preview scale of screens
	Preview window using data	Preview data used by screen
	Cascade	Cascade MDI window
	Horizontal tiling	Tile MDI window horizontally
	Vertical tiling	Tile MDI window vertically
	Code convert	Open a code convert
	Help	Open online help
	Language selection	Select language
	Off-line simulation	No need to connect PLC while testing the compiled project on PC
	On-line simulation	Need to connect PLC while testing the compiled project on PC
	Ethernet monitoring	Construct network on PC to execute collective remote

















		control
	Calculator	Open the calculator
	Draw	Open the drawing board



### 3) Design components

Select whether to display design element toolbar or not, please see the below figure.



	Text	Place a new text
	Register	Place a new register
	Indicator	Place a new indicator light
	Digital display	Place a new digital display unit
	bit operation switch	Place a new bit operation switch
	historical trend chart	Place a new history tendency chart
	Real-time trend chart	Please a new waveform chart
	Bar graph	Place a new bar graph
	Meter	Place a meter clock









	picture	Place a new picture
	GIF Picture	Place a new GIF picture
	Dynamic text	Place a new dynamic text
	Function key	Place a new function key
	Variable Text	Place a new variable text
	Letter combinations	Place new letter combinations
	Roll lamp	Place a new roll lamp
	Table	Place a new table unit
	Date	Place a new data unit
	Time	Place a new time unit
	Flow block	place a new flow block part
	SQL query	place a new SQL query component
	Data save	Place a new data save unit
	Historical data sheet	Place a new historical data sheet
	recipe data list	Place a new recipe data list
	Alarm record	Place a new alarm record list
	Real-time alarm table	Place a new real-time alarm table

	Amendment record list	Please a new amendment record list
	Memo	Place a new memo

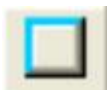
#### 4) Drawing Elements

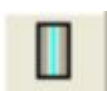
Select whether to display drawing element toolbar.



	Rectangle	Place a new rectangle
	Concave rectangular	Place a new concave rectangle
	Convex rectangular	Place a new convex rectangle
	Horizontal pipe	Place a new horizontal pipe
	Vertical pipe	Place a new vertical pipe
	Pipeline joints	Place a pipeline joint
	Graduation	Place a new scale
	Line	Place a new line
	Ellipse	Place a new ellipse











#### 5) Editing Tools

Select whether to display editing toolbar or not, see the below figure.

Paragraph Styles; Font Names; Font Size; Font Color; Bold ; Italic; Underline; AlignLeft; Center; Align Right; Bullets; Numbered List; Decrease Indent; Increase Indent.



	left justifying	Align selected units to the left
	center horizontally	Horizontally center selected unit
	Align Left	Align selected units to the right
	Align top edge	Align selected units to the top edge
	Center Vertically	Vertically center selected unit
	Align from Bottom	Align selected units to the bottom
	Same width	Set the select unit the same width with the standard ones
	Same height	Set the select unit the same height with the standard ones
	Same size	Set the select unit the same size with the standard ones
	Lock	lock elements, prevent well-adjusted pages from accidentally damage
	Deblocking	Deblock the locked units

	Pushed down to the bottom	Pushed selected units to the bottom
	Multiple copy	Select an unit and multiply copy it
	Static text	place a new static text element
	Slide block	place a new slide block part
	Drop-down box	Place a new drop-down box component
	Dynamic alarm bar	Place a new dynamic alarm bar component
	Polymorphic button	Place a new polymorphic button component
	Multi-state indicator light	Place a new multi-state indicator unit
	Sector chart	Place a new pie chart component
	Audio playback	Place a new audio playback component

## 6) State Bar

Select whether to display the state bar or not, please see the below figure:



### 3.4 Tool

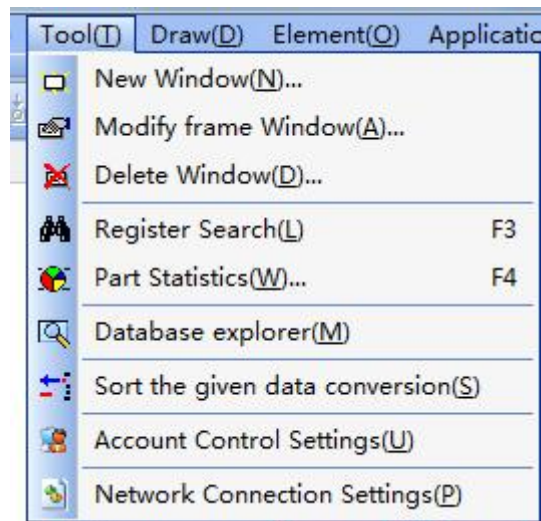

#### 1) New Window

Add an edit screen, the screen name is decided by the user or defaulted by the system. click [New Window] in [Tool] dialog box or the icon , then the following dialog appears.

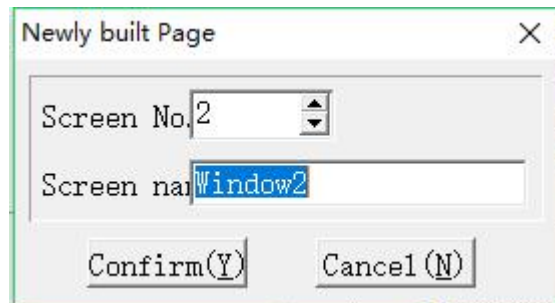

Reset picture NO. and screen name, or use the default ones, then click [Confirm].

## 2) Modify frame Window

Click [Modify frame Window] or the icon , the following dialog appears.

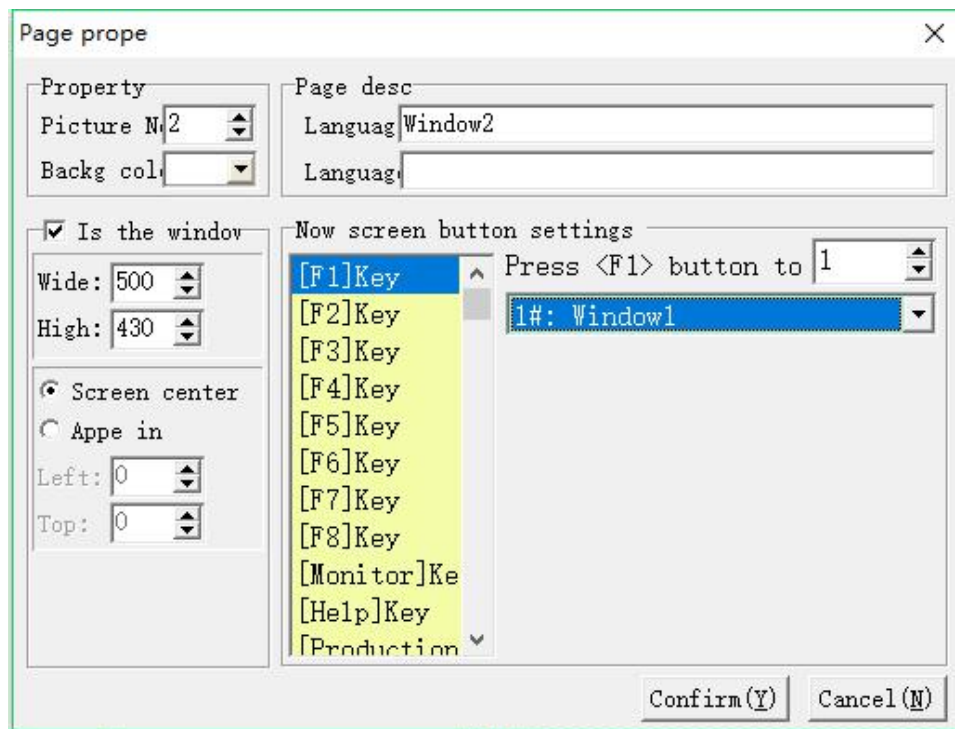

Whether modify the page to a window and the width and height, the back color and description can be decided here.(The current screen button setting function is not supported at this time)

## 3) Delete Window

Delete the current page and relevant units (Note: when execute the operation, the deleted window cannot be withdraw. Please think twice before execution. Click [Delete Window] or the icon . Then the following dialog will pop up.



#### 4) Register Search

You can select the [Register Search] option under [Tools], or press the icon , Hotkey F3/Ctrl + F . After that, the register search dialog box will appear as shown below:

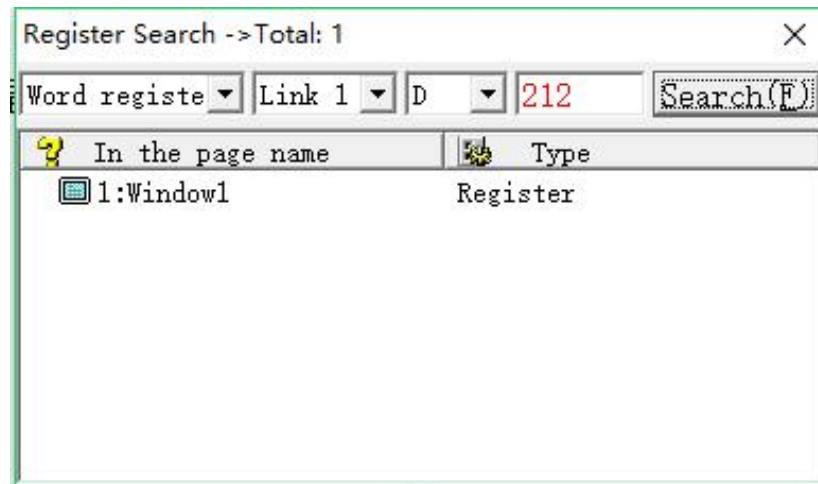

When using this function, first set the basic conditions of the registers you want to find, and then click the [Find] button. The searched component will be displayed in the output bar. Double-click an option in the output bar and the cursor will be automatically selected to the component.

## 5) Part Statistics

Collect statistics for the application of current window, click [Part Statistics], or use the hot key F4, as below figure:

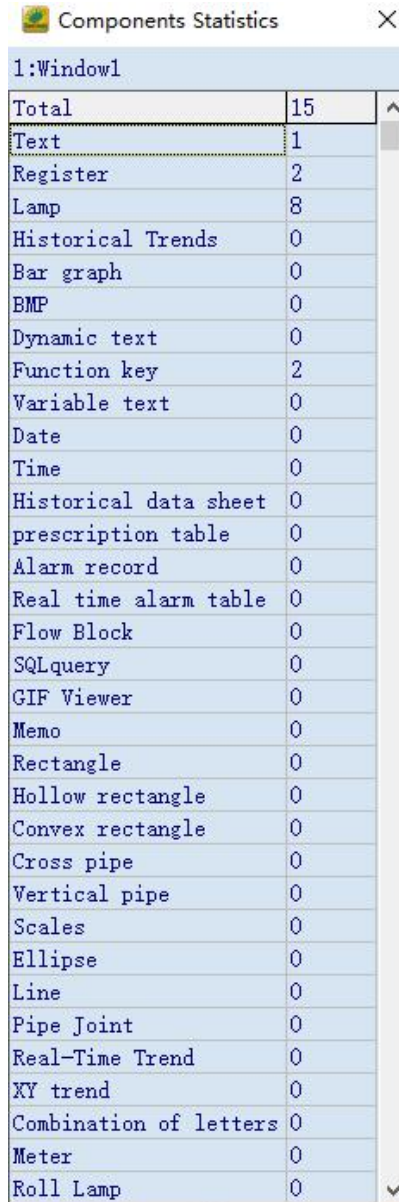

The screenshot shows a window titled 'Components Statistics' with a close button (X) in the top right corner. The window displays a table of component counts for '1:Window1'. The table has two columns: the component name and its count. The total count is 15.

1:Window1	
Total	15
Text	1
Register	2
Lamp	8
Historical Trends	0
Bar graph	0
BMP	0
Dynamic text	0
Function key	2
Variable text	0
Date	0
Time	0
Historical data sheet	0
prescription table	0
Alarm record	0
Real time alarm table	0
Flow Block	0
SQLquery	0
GIF Viewer	0
Memo	0
Rectangle	0
Hollow rectangle	0
Convex rectangle	0
Cross pipe	0
Vertical pipe	0
Scales	0
Ellipse	0
Line	0
Pipe Joint	0
Real-Time Trend	0
XY trend	0
Combination of letters	0
Meter	0
Roll Lamp	0

## 6) Database Explorer (Only MT60 Series HMI support this)

Search the historical data list. history tendency chart. alarm record list and other data stored in database storage area, which is exported by U disk. These data can be convert to excel and curve through database explorer.

HMI Database Browser V1.66 - [ G:\Buffer1\_20180919.db ]

Open Clear Sum Data:1606 Reco#1 16bit Unsigned ExportXLS OutCurve

Data ID	Record Date	Record Time	Data0	Data1	Data2	Data3	Data4	Data5	Data6	Data7	Data8	Data9
0	2018-09-19	10:54:20	3542	3552	20430	20430	0	0	0	0	0	0
1	2018-09-19	10:54:49	3542	3552	20430	20430	0	0	0	0	0	0
2	2018-09-19	10:55:18	3542	3552	20430	20430	0	0	0	0	0	0
3	2018-09-19	10:55:48	3542	3552	20430	20430	0	0	0	0	0	0
4	2018-09-19	10:56:17	3542	3552	20430	20430	0	0	0	0	0	0
5	2018-09-19	10:56:46	3542	3552	20430	20430	0	0	0	0	0	0
6	2018-09-19	10:57:16	3542	3552	20430	20430	0	0	0	0	0	0
7	2018-09-19	10:57:45	3542	3552	20430	20430	0	0	0	0	0	0
8	2018-09-19	10:58:14	3542	3552	20430	20430	0	0	0	0	0	0
9	2018-09-19	10:58:44	3542	3552	20430	20430	0	0	0	0	0	0
10	2018-09-19	10:59:13	3542	3552	20430	20430	0	0	0	0	0	0
11	2018-09-19	10:59:42	3542	3552	20430	20430	0	0	0	0	0	0
12	2018-09-19	11:00:12	3542	3552	20430	20430	0	0	0	0	0	0
13	2018-09-19	11:00:41	3542	3552	20430	20430	0	0	0	0	0	0
14	2018-09-19	11:01:10	3542	3552	20430	20430	0	0	0	0	0	0
15	2018-09-19	11:01:40	3542	3552	20430	20430	0	0	0	0	0	0
16	2018-09-19	11:02:09	3542	3552	20430	20430	0	0	0	0	0	0
17	2018-09-19	11:02:39	3542	3552	20430	20430	0	0	0	0	0	0
18	2018-09-19	11:03:08	3542	3552	20430	20430	0	0	0	0	0	0
19	2018-09-19	11:03:39	3542	3552	20430	20430	0	0	0	0	0	0

## 7) Account Control Settings

When used in computers with win7 and win8 / win10 system,account control settings need to be changed, move the cursor to never notify.

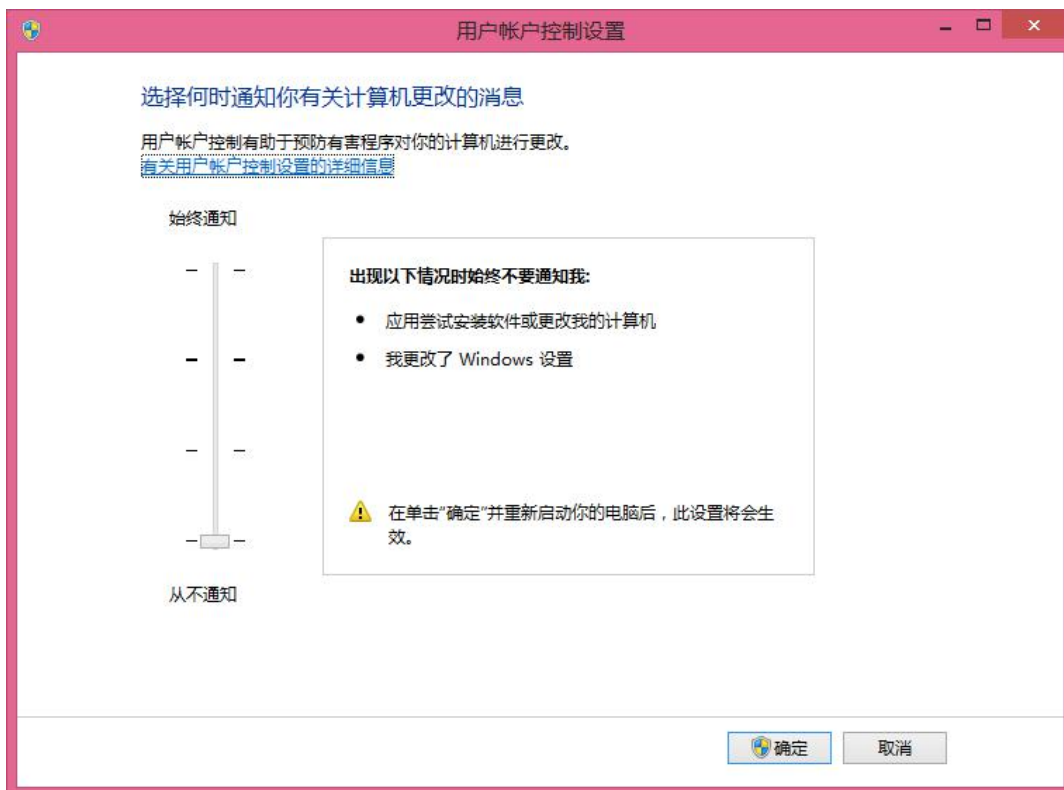

## 8) Network Connection Settings

When HMI download cable well connected with a computer, local area connection named Coolmay HMI will be added automatically. Right click it, select property and the IP address can be checked. If it is obtain IP addresses automatically, it can be selected to use the following IP address, set it as 222.222.222.X. Set subnet mask as 255.255.255.0. For example, set IP address as 222.222.222.3, subnet mask as 255.255.255.0. If there isn't any automatic identification, please turn to Coolmay official website ([www.coolmay.net](http://www.coolmay.net)) and check the driver installation steps of win7 32/64 and Win8, Win10 system touch screen comes with driver installation steps. Note: Win8, win10 systems must turn off digital signatures.

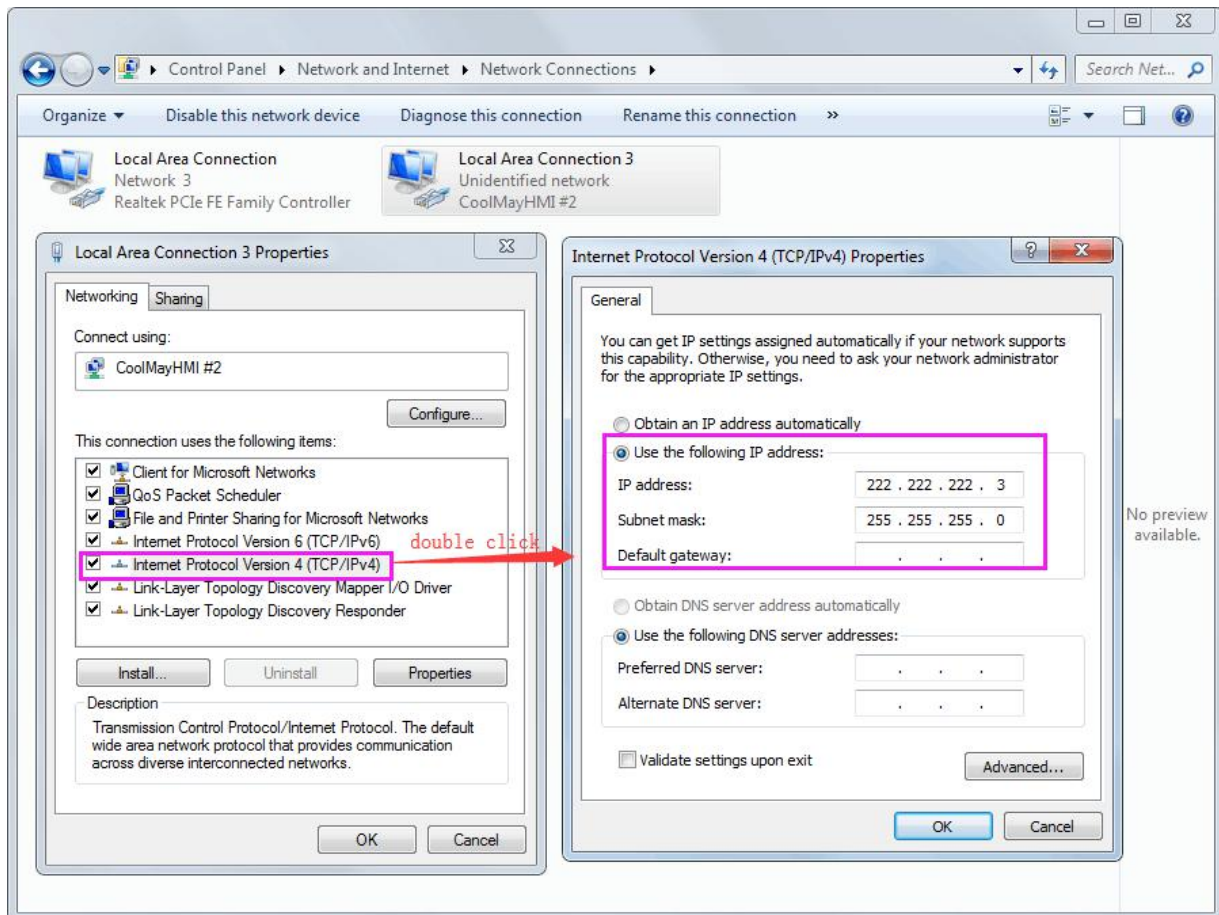

## 3.5 Drawing Menu

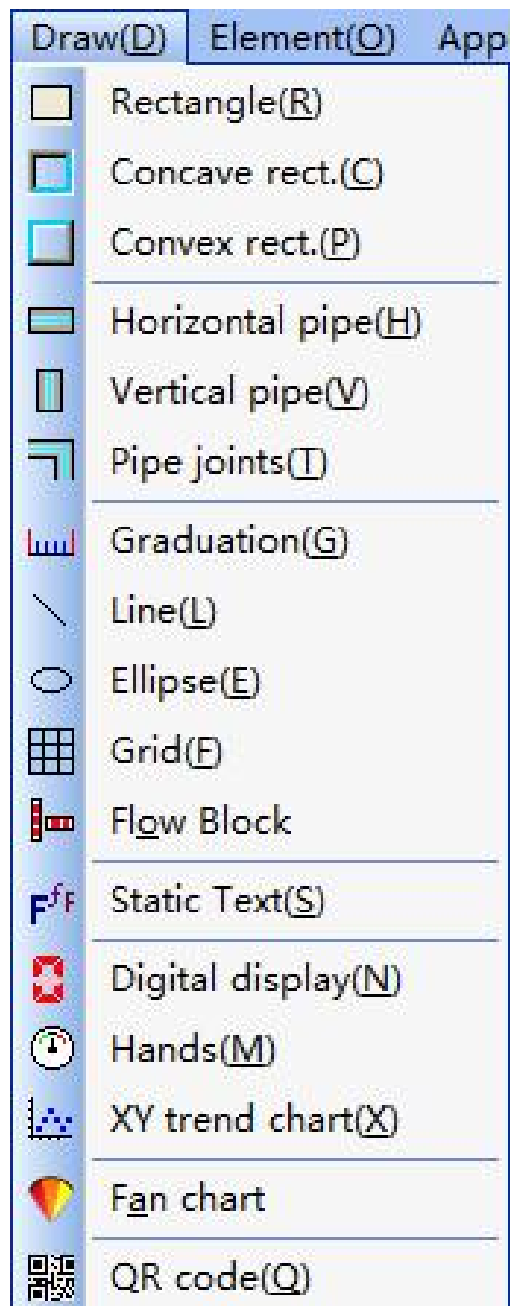



### 3.6 Element Menu

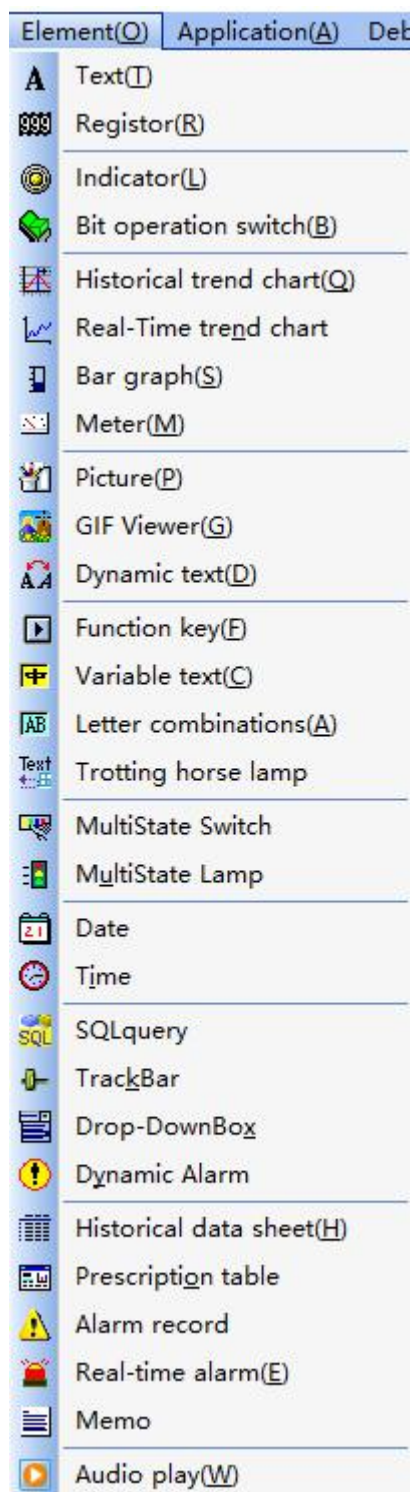

CoolMayHMI provides 46 types of components. For details, please refer to the above two pictures. You can directly select the components you need to edit through the menu. The component is placed in the screen editing area of CoolMayHMI, as shown in the figure.



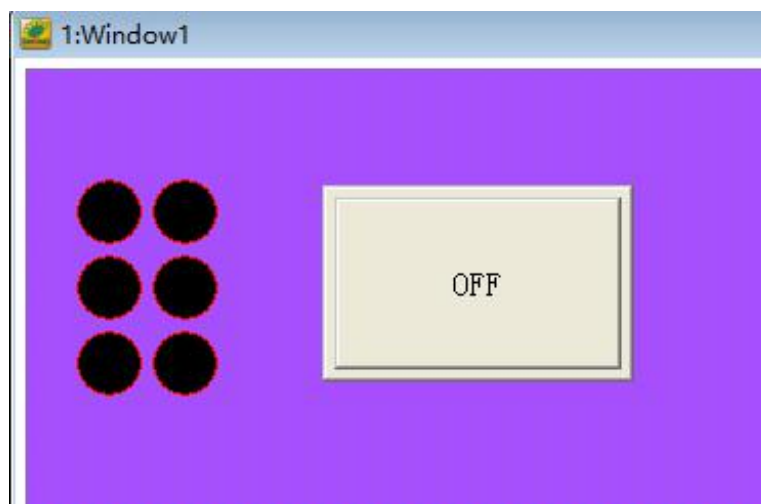



Please refer to Chapter 3 for the setting of component properties for various classes.

### (1) Movement of components

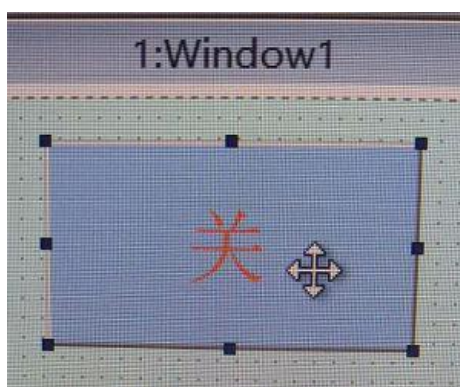
The operation of the mouse, whether it is pressing the left button or the right button, is the same as using windows. When the mouse has a symbol  on the component, hold down the left mouse button to move the mouse to move the component.



### (2) Change in component width

When the mouse moves over the symbol to become a symbol , hold down the left mouse button to move the mouse to change the left and right range of the component. Figure:



### (3) Change in component height

When the mouse moves over the symbol to become a symbol , hold down the left mouse button to move the mouse to change the left and right range of the component. Figure:

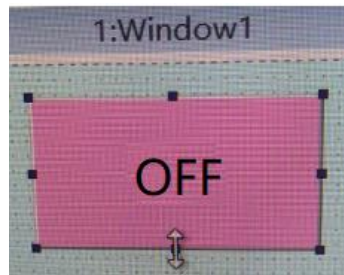

### (4) The width and height of the component change simultaneously

When the mouse moves over the component to become a symbol , hold down the left mouse button to move the mouse to change the up, down, left, and right range of the component. Figure:

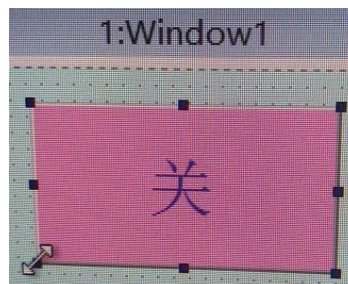

### (5) The width and height of the component change simultaneously

When the mouse moves over the component to become a symbol ,

holding down the left mouse button to move the mouse can also change the up, down, left, and right range of the component. Figure:

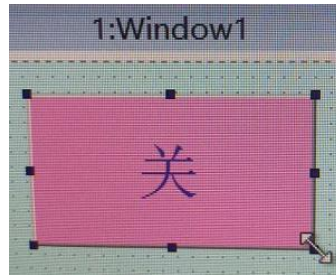

### (6) Press the right mouse button

Clicking the right mouse button and clicking on different places will have different functions. Figure:

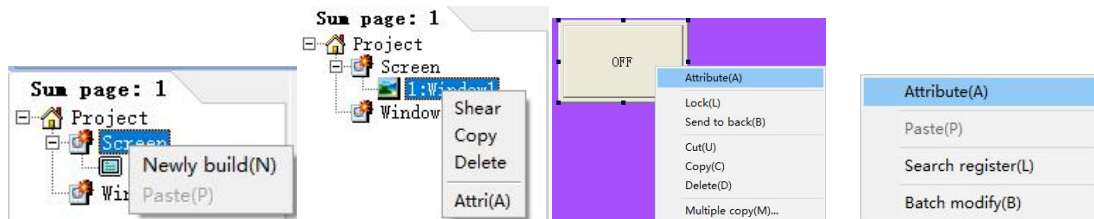

## 3.7 Application

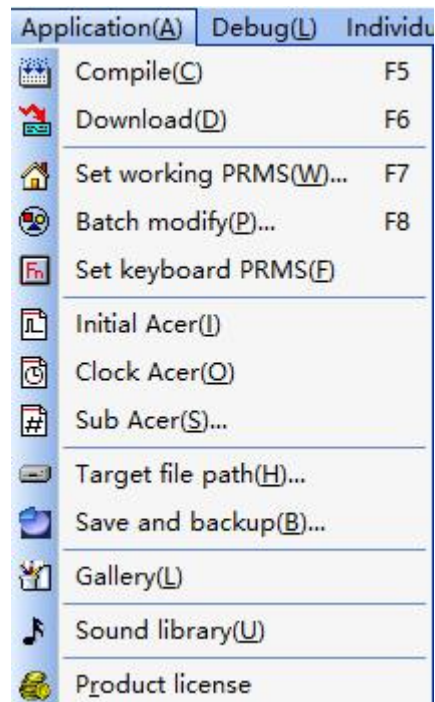

## 1) Compile

By selecting this item, the editing element can be compiled to the format which can be accepted by HMI. If this item is a newly opened project, the file should be stored before compiling. If this item has a backup or it is an old file, users can compile directly. During the compiling process, messages can be export to the output field. If there are errors, they will be listed at the same time to remind users. If error occurs, element file won't be generate. Users can click [Compile] or click the icon , or use the hotkey F5.

Compile Error:

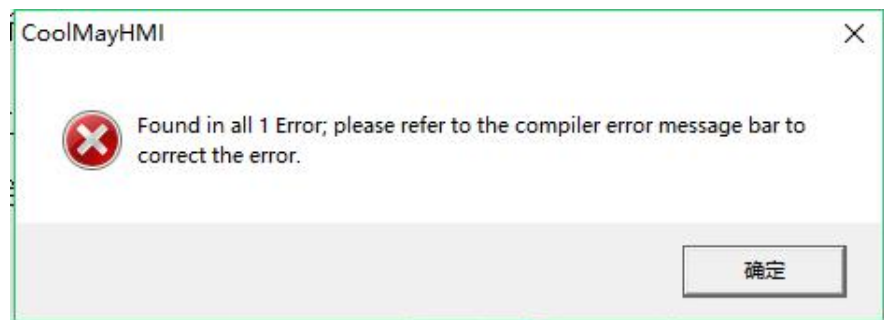

Compile message:

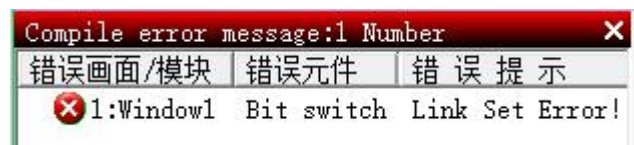

## 2) Download

Download window data to HMI, click it or click  in the toolbar, or use the defaulted hotkey F5. If the PC cannot be connected with HMI, error messages will pop up to remind users, such as the below diagram.

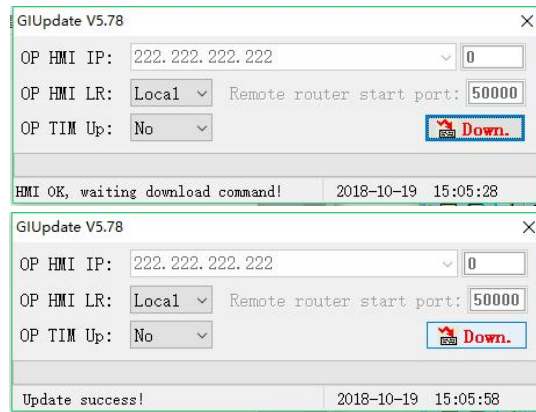

### 3) Parameter Settings

Set the working parameters of current project, click it or click  in the toolbar, or use the defaulted hotkey F7. Specific settings include communication settings, network settings, alarms/others, glyphs/language, record buffers, recipe settings, and other six areas. For details, please refer to "Chapter 5 System Control Area" Description.

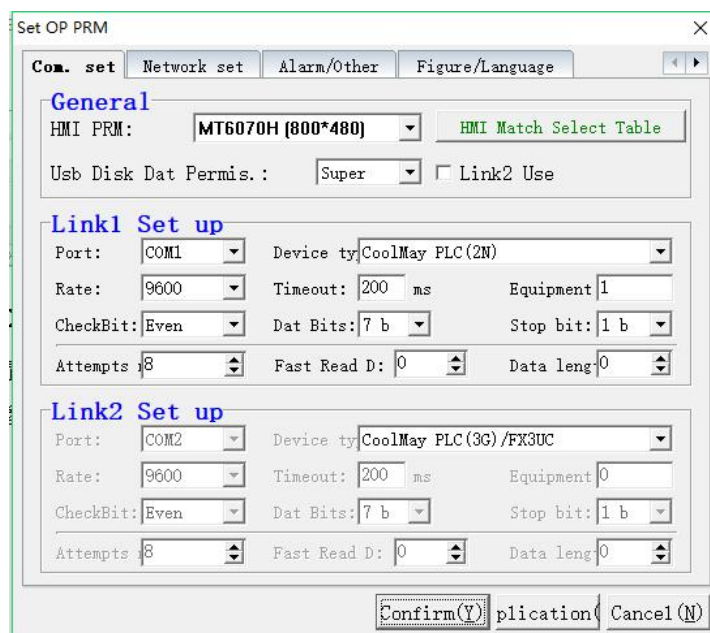

- HMI parameter: select resolution according to different HMI.

HMI Match Select Table

HMI Simple Name	HMI Matching Type	Touch Screen PLC Integrated Machine Matching
MT6037H (320*240)	MT6037H	*
MT6043H (480*272)	MT6043H (A) /MT6043KH (A)	EX2N-43H (A) /EX2N-43KH (A) (480*272)
MT6043HV (272*480)	MT6043H (A) V/MT6043KH (A) V	EX2N-43H (A) V/EX2N-43KH (A) V (272*480)
MT6047H (480*320)	MT6047H	*
MT6070HV (480*800)	MT6070H (AS) V/MT6050H (A) V/MT6050KH (A) V/MT6100HV	EX2N-70H (AS) V/EX2N-50KH (A) V/EX2N-100HV (480*800)
MT6070H (800*480)	MT6070H (AS) /MT6050H (A) /MT6050KH (A) /MT6100H	EX2N-70H (AS) /EX2N-50KH (A) /EX2N-100H (800*480)
MT6080H (800*600)	MT6080H	*
MT6104H (1024*768)	MT6104H	*
MT6100HA (1024*600)	MT6100HA/MT6070HA	EX2N-100HA/EX2N-70HA (1024*600)
MT6100HAV (600*1024)	MT6100HAV/MT6070HAV	EX2N-100HAV/EX2N-70HAV (600*1024)
MT6185H (1366*768)	MT6185H	*
MT6185HV (768*1366)	MT6185HV	*
SoftOP (920*600)	SoftOP (920*600)	*
SoftOP (1152*768)	SoftOP (1152*768)	*
SoftOP (1266*702)	SoftOP (1266*702)	*
SoftOP (自定义)	SoftOP (自定义)	*

●Link2: choose whether to use Link2 communication function or not.

●COM port: Set the communication port for communication with man-machine,

COM1 is 232 communication;

COM2 is 485 communication;

COM is temporarily not supported, it is empty;

CAN is can2.0 communication;

Ethernet is network port communication.

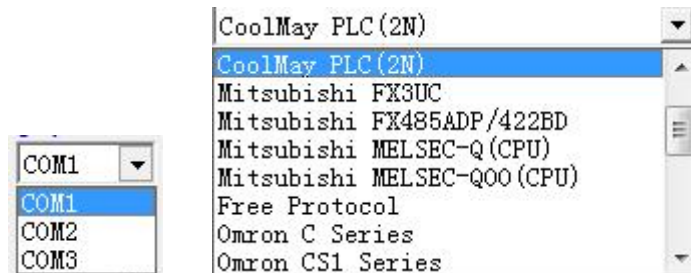

●Baud rate: 1200. 2400. 4800. 9600. 19200. 38400. 57600. 115200. 187500. 460800. 921600.

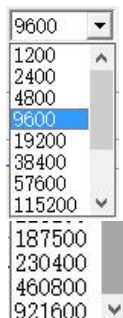



- Communication timeout: set “communicate timeout”, the default time is 200(ms) when communication with PLC.

- PLC ID: set PLC station number, from 1 to 255.

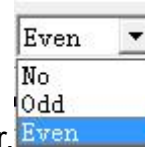

- Inspect bits: select NULL. odd number or even number.

- Data bits: select 6 bits, 7bits or 8 bits.

- Stop bits: select 1 bits or 2 bits.

#### 4) Batch modify

Batch modify all attribute of each project,click [Batch modify] in [Application] dialog box,or click  in the toolbar, or use the defaulted hotkey F8.

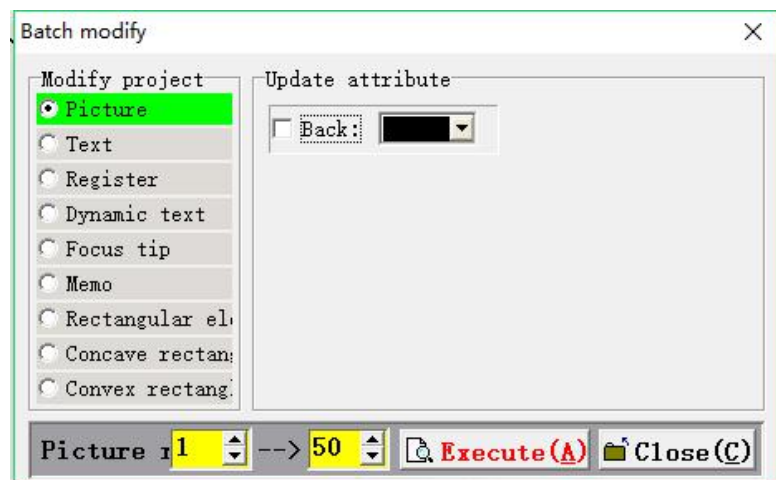

##### ◆ Modify Item

Select picture, text, register, dynamic text, focus hint, memo, rectangle element, concave rectangle element, convex rectangle element.

##### ◆ Modify Property

According to the change of the selected item, the content of the modified attribute is also different; after selecting the attribute that needs to be modified in batches, reset the new color or value, and press the “Execute” button to automatically modify the related attributes of all the components in the range of the screen.

#### ◆ Screen scope

Set the effective range of bulk editing, set value:1-240.

### 5) Set keyboard keys and indicator

Set the communicate ID of keys and keyboard LED indicator. Click [Set keyboard keys and indicator] in [Application] dialog box, or click  in the toolbar. The below figure appears.

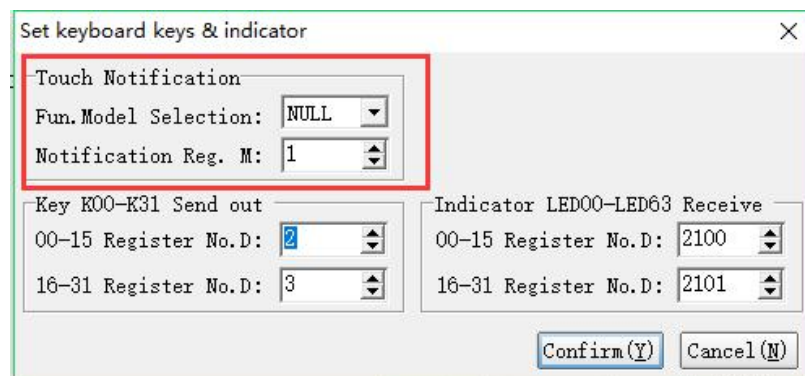

### 6) Initial

Compile initial macro, detailed information please refer to chapter four .

Click [ Initial ] in [Application] , or click the icon  in the toolbar.

### 7) Clock

Compile clock macro, detailed information please refer to chapter four. Click [Clock] in [Application] , or click the icon  in the toolbar.



## 8) Sub

Compile sub macro, detailed information please refer to chapter four. Click [Sub] in [Application] , or click the icon  in the toolbar.

## 9) Target File Path

The output path of target file, the already compiled file will be stored here. Click [ Target File Path] in [Application] dialog box, or click the icon  in the toolbar, then the following dialog will pop up.

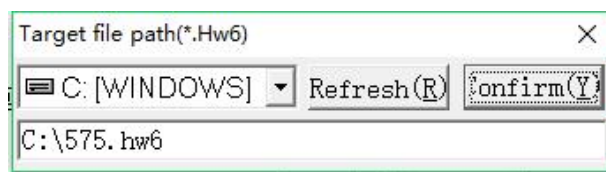

## 10) Save and Backup

Set whether autosave or not in fixed time, units: minute (m) ; select whether create backup “.bak” each time you save, You can directly select the [Save and Backup] option under [Application]. the following figure appears:

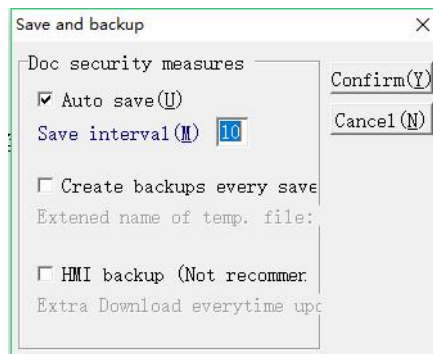

## (11) Gallery

Open the graphics library to view and select the images used by the project. You can directly select the [Gallery] option under [Application], and the following will appear:

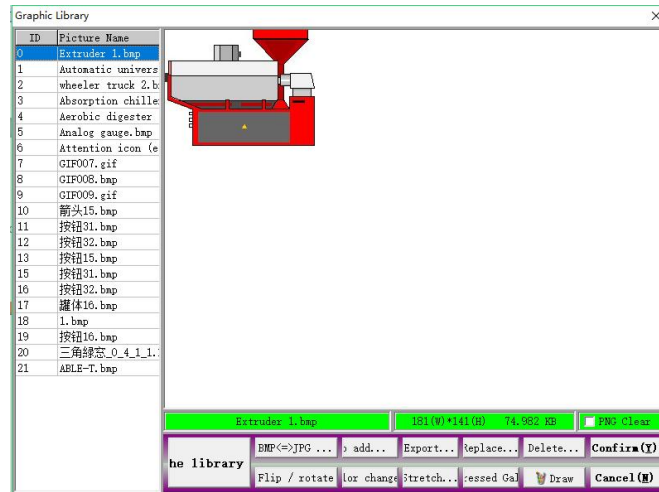

## (12) Sound library (only MT60 series HMI support)

Open the sound library to view and select the sound files used by the project. You can directly select the [Sound Library] option under [Application], or directly click the icon  on the toolbar. After that, the picture will appear:

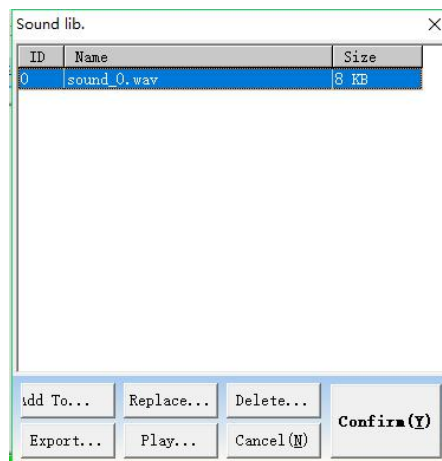

**Note:** The sound library needs to be used with audio playback components.

## (13) Product Authorization

The product authorization is used to specify the usage time of the human-machine interface. When the time is up, the lock screen setting of the human-machine interface must be unlocked by unlocking the password, so that the human-machine interface can be human-computer interaction again. (You can use the number of days and expiration time to lock the display unit.)

In the touch screen software, select the [Product Authorization] option under [Application]. After that, the picture will appear:

Periods	Days set	Unlock Password	Reminder Statement
<input type="checkbox"/> Period 1	1	123^abc_ABC	The first phase arrives, please cont
<input type="checkbox"/> Period 2	1	123^abc_ABC	
<input type="checkbox"/> Period 3	1	123^abc_ABC	
<input type="checkbox"/> Period 4	1	123^abc_ABC	
<input type="checkbox"/> Period 5	1	123^abc_ABC23456	

Function selection- no: no product authorization function is used;

Calculated by the due date: set to execute the product authorization function until the set date;

Calculated by the number of days of use: that is, set to implement the product authorization function after several days;

Execution time of the day: that is, when the expiration date is set, the product authorization function is executed.

Period setting: Up to 5 periods can be set, which is equivalent to level 5 authorization.

Each period can be set to use the number of days or deadline, password, reminder statement (displayed when the screen is locked).

Notification setting: After selecting the notification bit, when the authorization expires, the auxiliary relay in the PLC can be set to ON/ OFF. In this way, after the authorization expires, not only the touch screen can be locked, but also the auxiliary relay in the PLC

can be controlled, so that the screen and the PLC can achieve the double locking effect at the same time.

### 3.8 Debug Menu

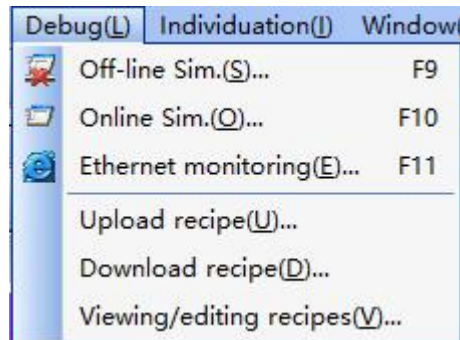

#### 1) Off-line Simulation

This function is used to test the editing window. read-write address and macros. Simulate project operation on PC without any connection. click [Off-line Simulation] in [Simulation] dialog box, or the icon , or hotkey F9, the below figure will pop up:

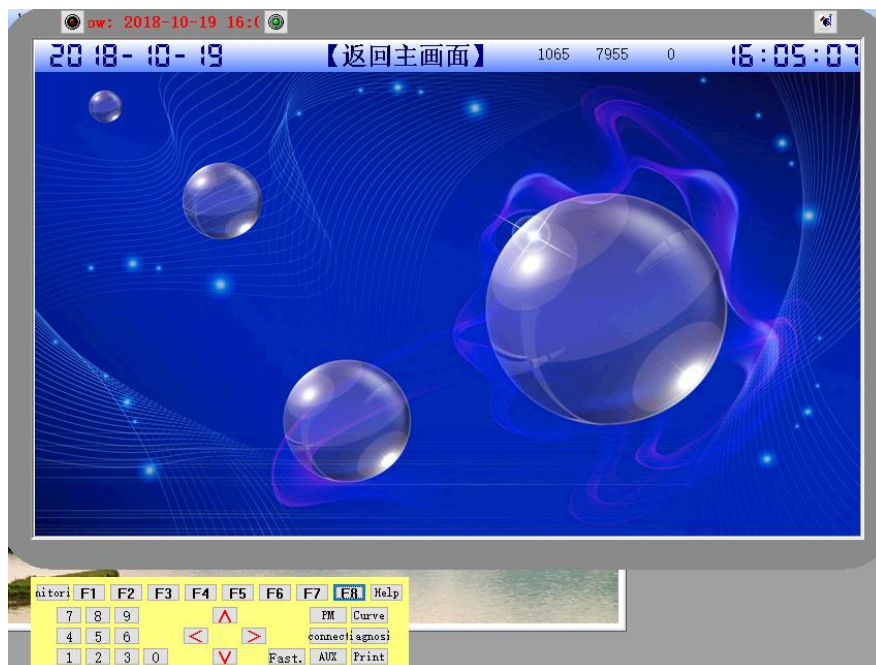

Action menu of Off-line Simulation: Click the icon  in the top right corner of simulation.

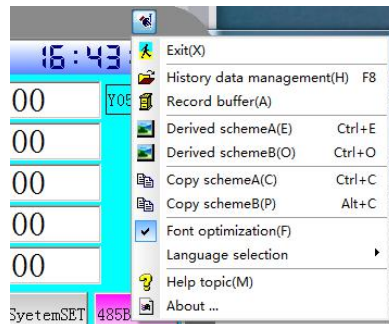

## 2) On-line Simulation

On-line simulation: Simulate project operation on PC and PLCs are directly connected with PC. Drive the connected PLCs through simulation on PC. Click [On-line Simulation] in [Simulation] dialog box, or click the icon , or use the defaulted hotkey F10.

Support for small systems within two sites of the same HMI. For details, please refer to the official website manual "*Introduction to the online simulation function of Coolmay configuration software*"

The execution situation please refer to the below figure.

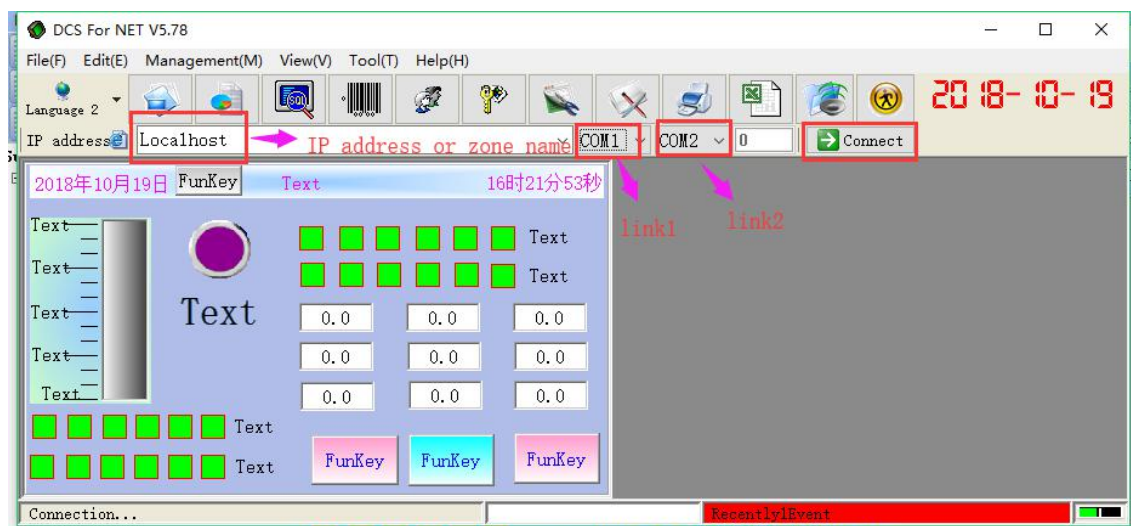

**Note:** During online simulation, the user password does not match the password set on the touch screen. Administrators must log in before modifying the encrypted register parameters.

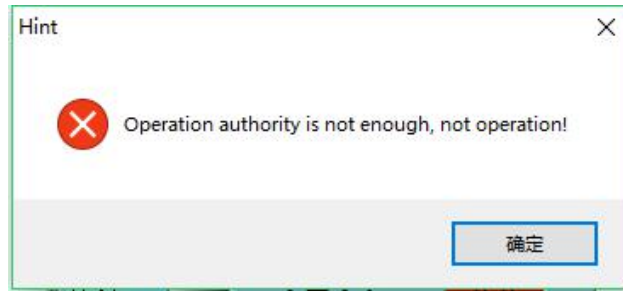

Click the icon  in the toolbar, the following dialog box appears:

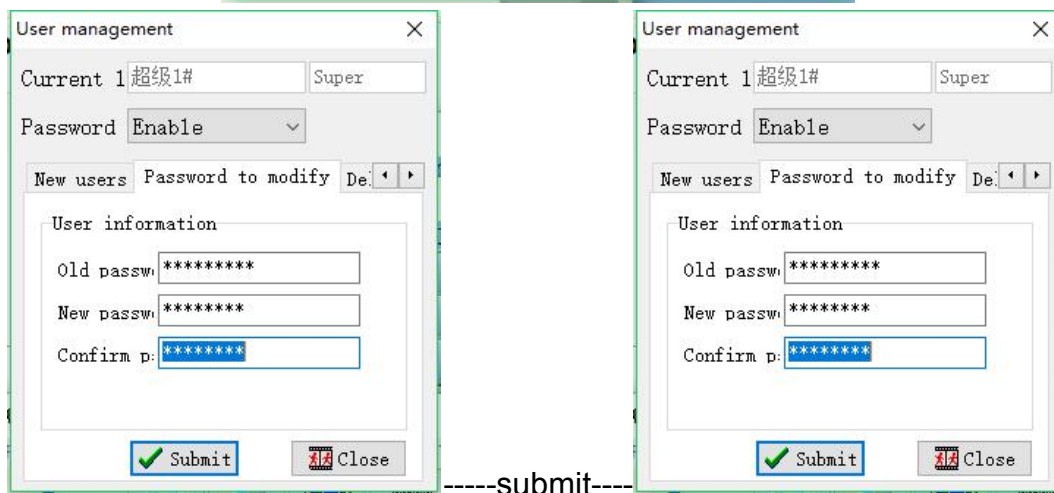

There is an initial administrator account, the user name “超级1#” and the password “0000000”. Please modify the administrator account after first time starting the system. (**Note:** Only the super login can have the right to modify other level passwords)

### 3) Ethernet monitoring

Conduct collectively remote control by constructing network on PCs. Click

[Ethernet Monitoring] in [Monitoring] dialog box, or click the icon , or use



the defaulted hotkey F11. The executed situation please refer to the below figure:

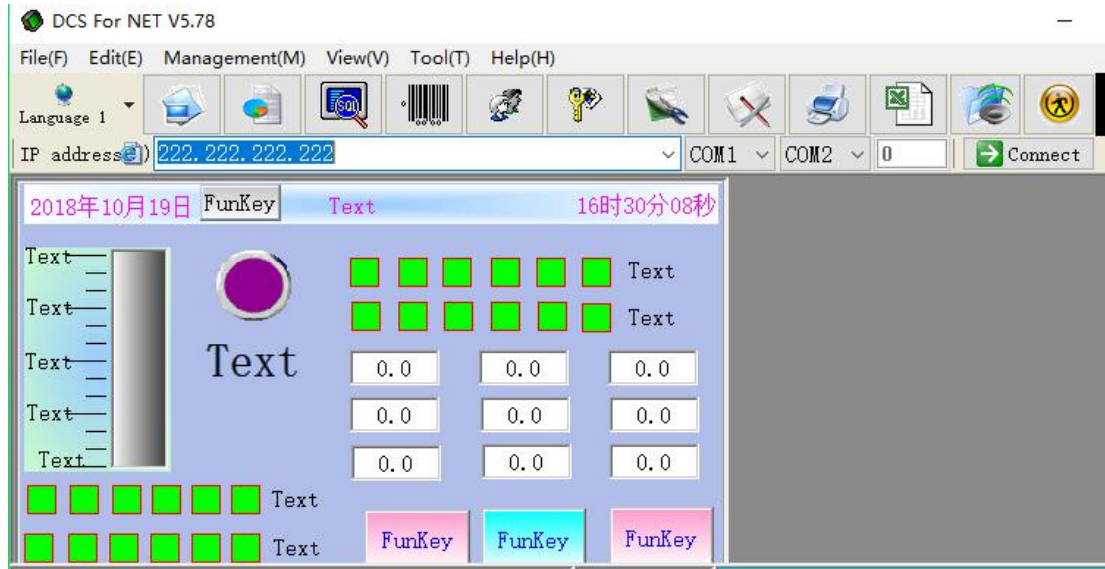

Among them, when using the touch screen download line for Ethernet monitoring, the IP address is set to "222.222.222.222",

When using the touch screen network port monitoring, the IP address setting corresponds to the touch screen IP address (that is, the IP address of the network cable that is connected to the touch screen network port). For details, please refer to the official website manual "Coolmay HMI network port and computer communication setting steps".

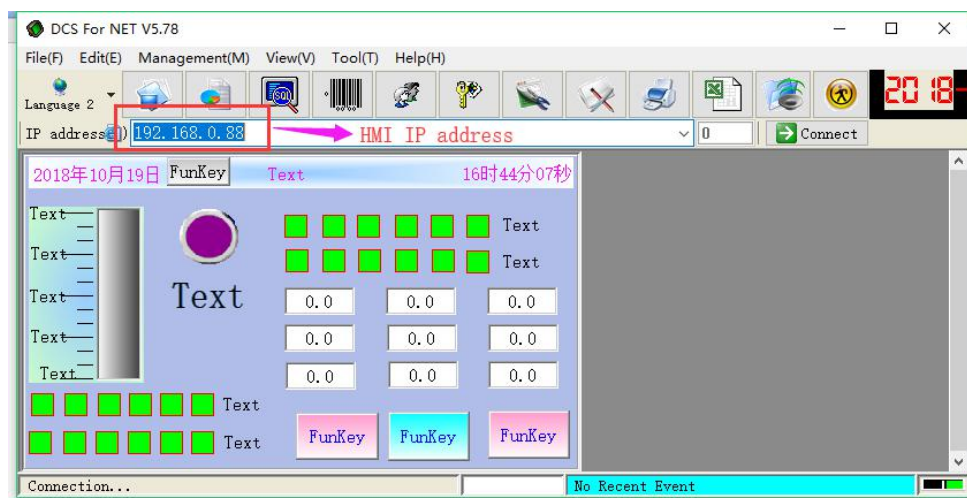

During Ethernet monitoring, Administrator Login should be conducted before modifying the parameters.

Click the icon  in the toolbar, then the following dialog box will pop up:

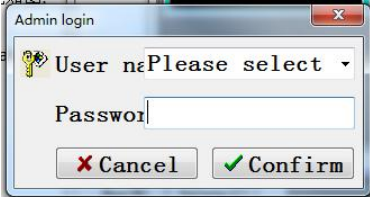

The dialog box is titled "Admin login" and contains the following elements:

- A key icon next to the text "User name: Please select" followed by a dropdown arrow.
- A text input field labeled "Password".
- Two buttons at the bottom: "Cancel" (with a red X icon) and "Confirm" (with a green checkmark icon).

There is an initial administrator account, the user name and the password are both `luo`. Please modify the administrator account after first time starting the system.

#### (4) Watch the editing recipe

When using the recipe data, you can select the [View/Edit Recipe] option under [Debug] to export, import, and copy the recipe. The implementation time is as follows:

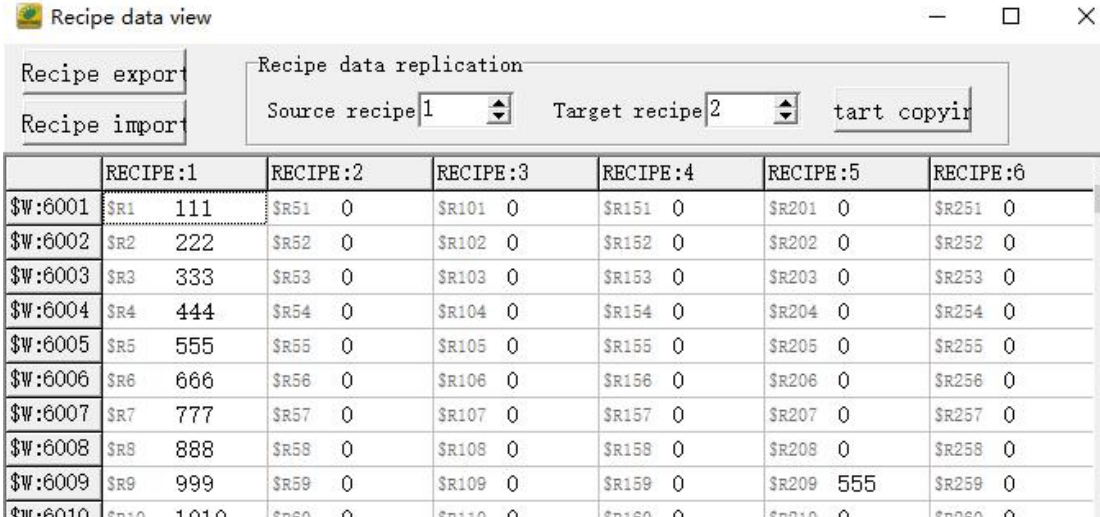

The "Recipe data view" dialog box shows a table for recipe data replication. It includes controls for "Recipe export", "Recipe import", "Source recipe" (set to 1), "Target recipe" (set to 2), and a "Start copy" button.

	RECIPE:1	RECIPE:2	RECIPE:3	RECIPE:4	RECIPE:5	RECIPE:6
\$W:6001	\$R1 111	\$R51 0	\$R101 0	\$R151 0	\$R201 0	\$R251 0
\$W:6002	\$R2 222	\$R52 0	\$R102 0	\$R152 0	\$R202 0	\$R252 0
\$W:6003	\$R3 333	\$R53 0	\$R103 0	\$R153 0	\$R203 0	\$R253 0
\$W:6004	\$R4 444	\$R54 0	\$R104 0	\$R154 0	\$R204 0	\$R254 0
\$W:6005	\$R5 555	\$R55 0	\$R105 0	\$R155 0	\$R205 0	\$R255 0
\$W:6006	\$R6 666	\$R56 0	\$R106 0	\$R156 0	\$R206 0	\$R256 0
\$W:6007	\$R7 777	\$R57 0	\$R107 0	\$R157 0	\$R207 0	\$R257 0
\$W:6008	\$R8 888	\$R58 0	\$R108 0	\$R158 0	\$R208 0	\$R258 0
\$W:6009	\$R9 999	\$R59 0	\$R109 0	\$R159 0	\$R209 555	\$R259 0
\$W:6010	\$R10 1010	\$R60 0	\$R110 0	\$R160 0	\$R210 0	\$R260 0



### 3.9 Individuation Menu

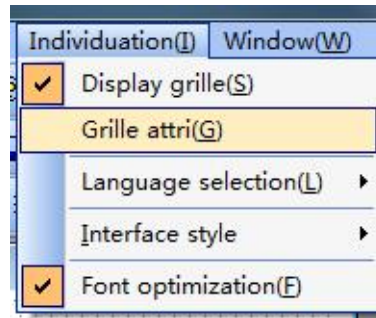

#### 1) Display Grille

Select whether display grids, click [Display Grille] in [Individuation] dialog



box, or click the icon , the two figures below are with grilles and without grilles.

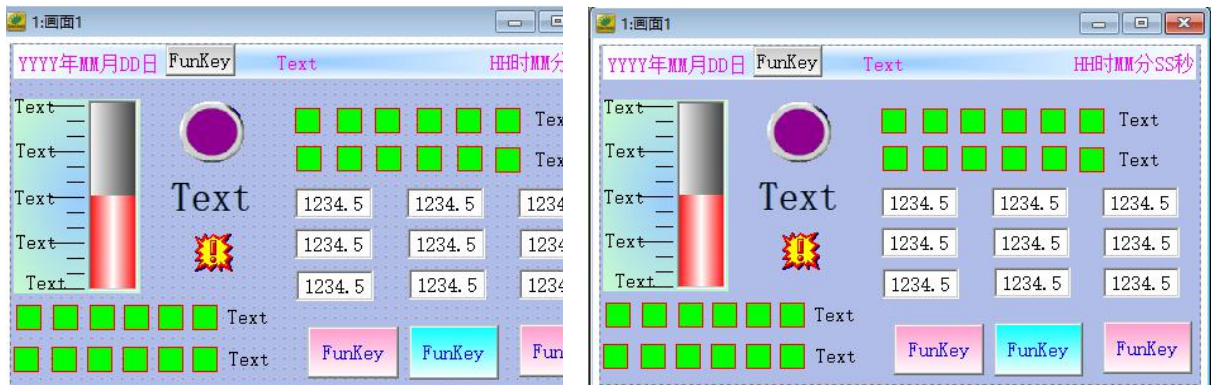

#### 2) Grille Attribution

Set grid attribution, click [Grille Attribution] in [Personalized] dialog box, then the below figure will pop up:



### 3) Language selection--Chinese or English

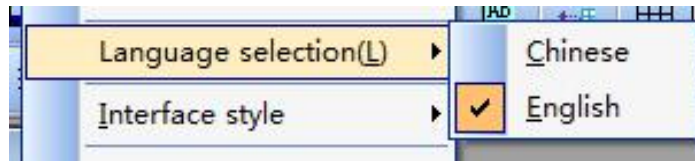

### 4) Interface style

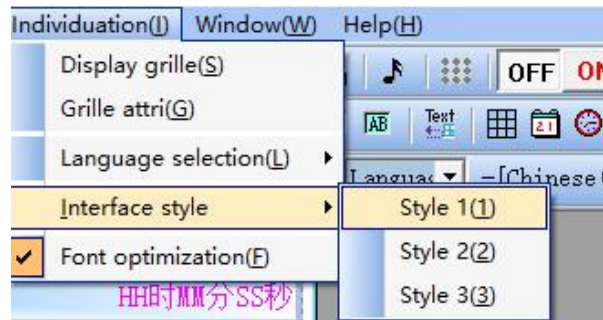

#### Style 1



#### Style 2

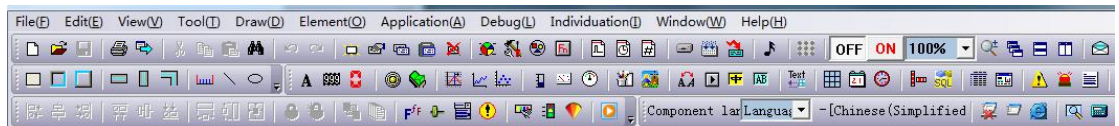

#### Style 3



### 5) Font optimization

Select whether to optimize font.



Before optimization

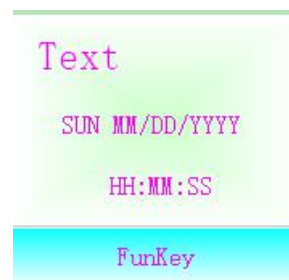

After optimization

### 3.10 Window

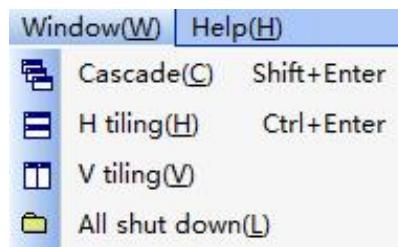

#### 1) Cascade

Screen images are displayed in the form of overlap, multiple images can be displayed at a time. All images will be displayed in the form of overlap after switching. Click [Cascade] in [Window] dialog box, or click the icon , or use the defaulted hotkey Shift+Enter. The effect images are as below:

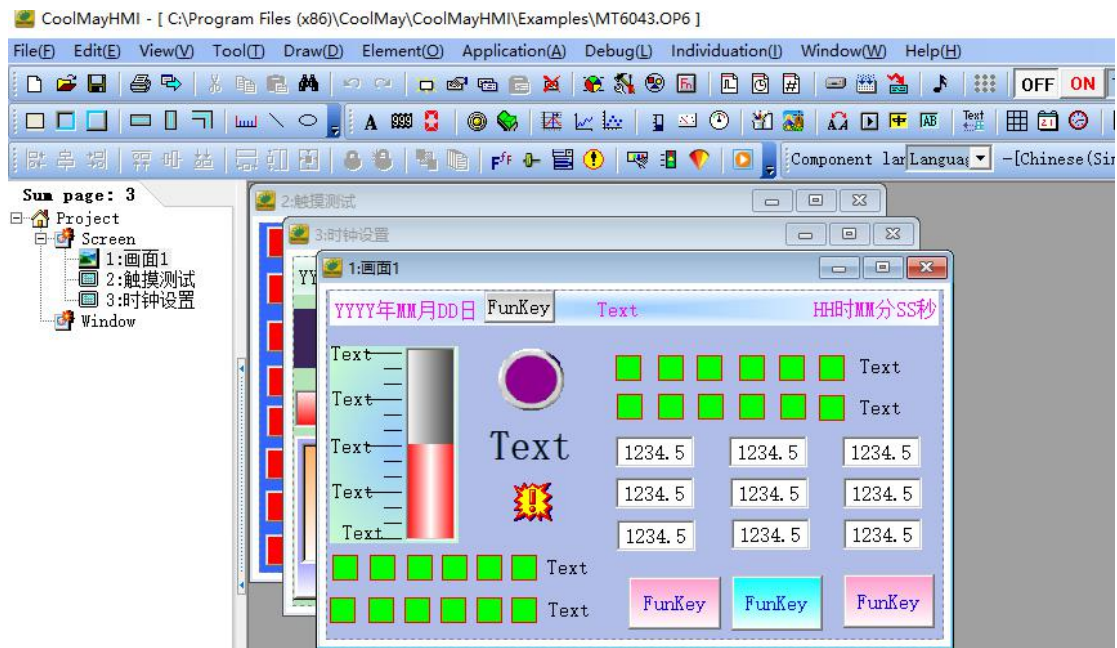

#### 2) Horizontal tiling

Screen images are displayed in the form of tile horizontally. The height will shrink automatically in order to display all the images, so multiply images can be displayed simultaneously. Click [Horizontal tiling] in [window] dialog box, or

click the icon , or use the defaulted hotkey Ctrl+Enter. The effect image is as below:

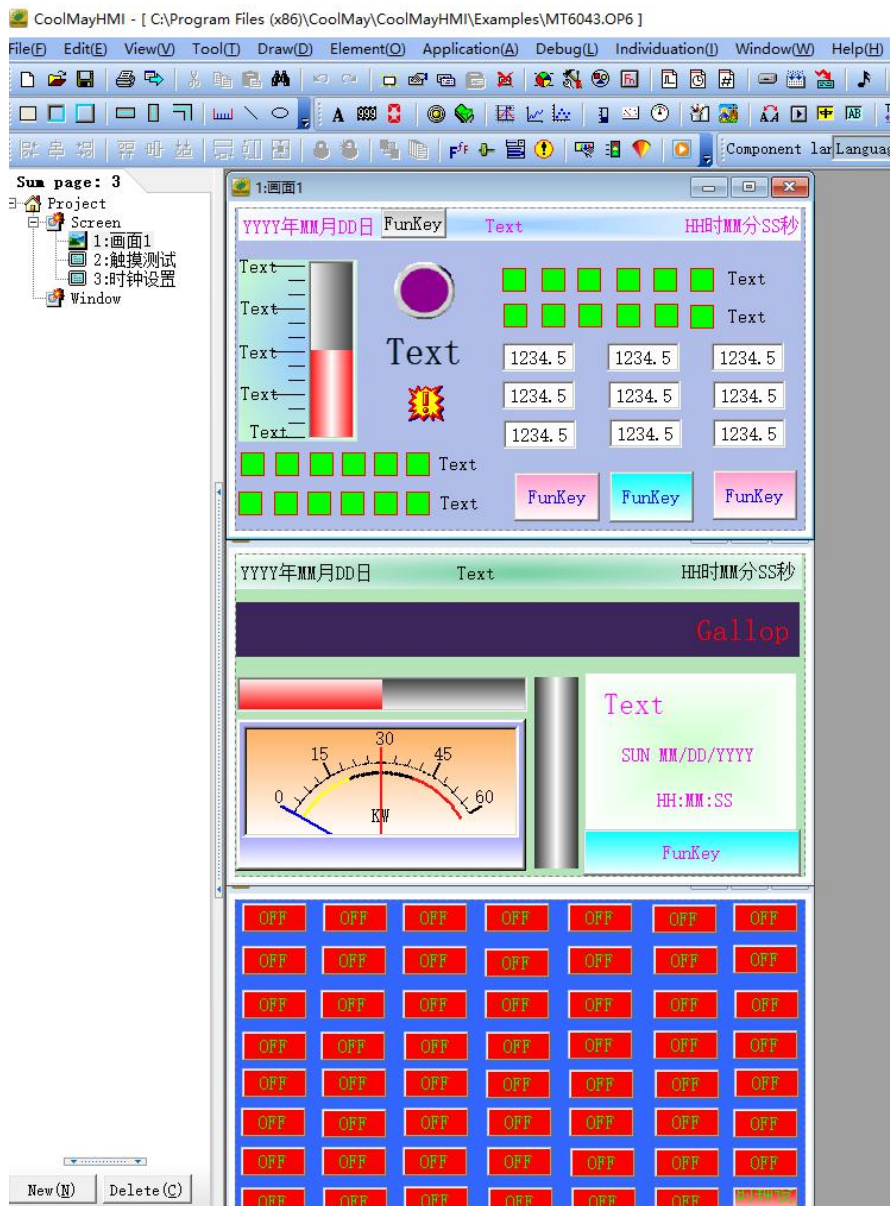

### 3) Vertical tiling

Screen images are displayed in the form of tile vertically. The width will shrink automatically in order to display all the images, so multiply images can be displayed at the same time. Click [Vertical tiling] in [Window] dialog box, or

click the icon .



The effect image is as below:

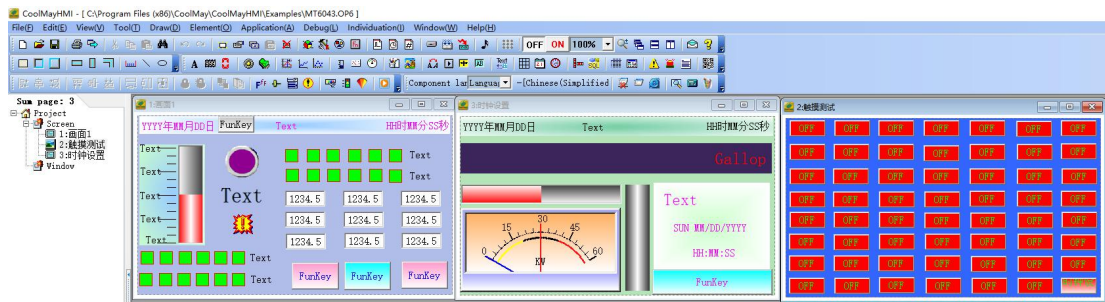

#### 4) All shut down

Close all MDI screen images. Click [All shut down] in [Window] dialog box.

### 3.11 Help Window

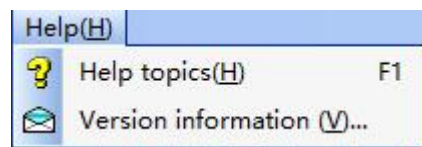

#### 1) Help Topics

Click it and then ONLINE HELP will appear. If you have any questions to inquire, you can turn to here firstly. Click [Help Topics] in [Help], or click the

icon  in the layout toolbar. The below figure will appear.

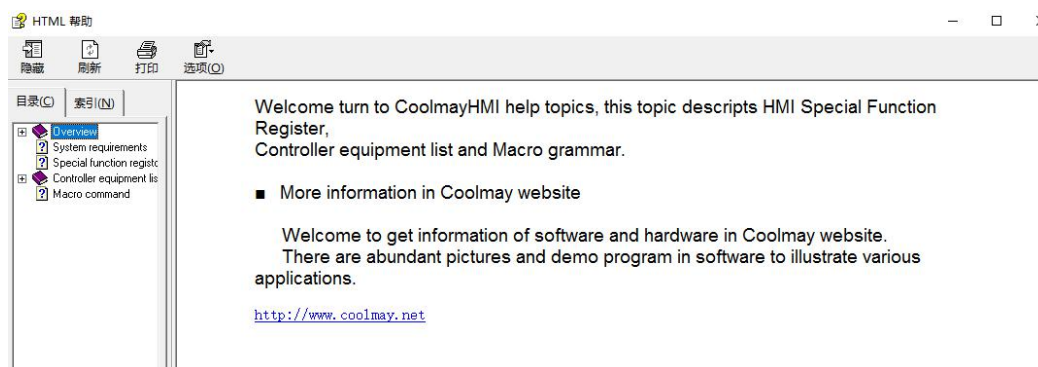

## 2) About CoolMayHMI

Display the version of CoolMayHMI, the latest version should be download in the official website (www.coolmay.net). Click [Version information], the below figure will appear.



## Chapter 3 Element Function

In order to let users understand that every element of CoolMayHMI has its own function, this chapter will give explanations to each of them.

### I How to select element

There are two ways to start elements.

1.[Draw]»[Element], select the element and then start editing.

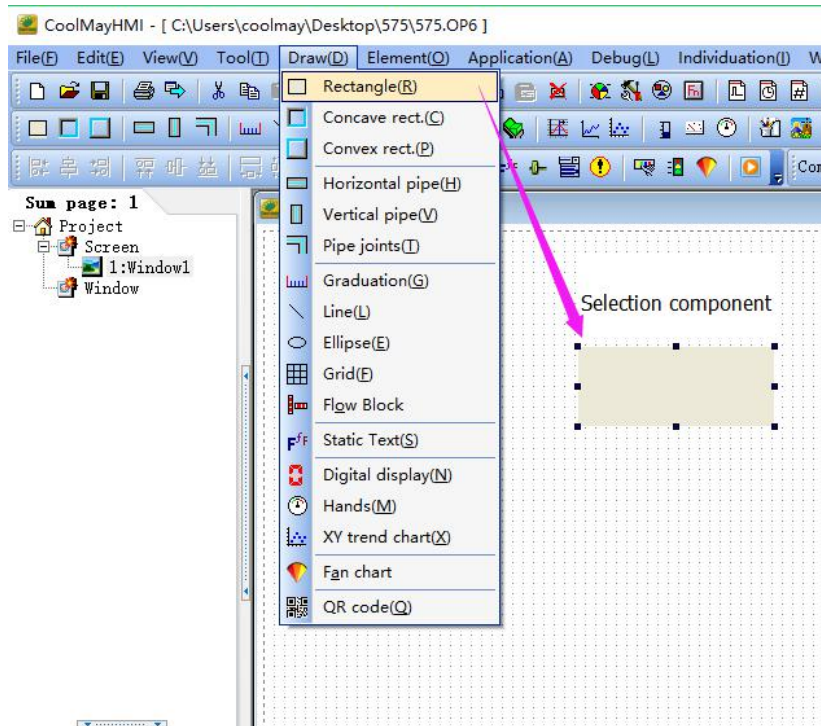

2. Click toolbar, select the element and then start editing.

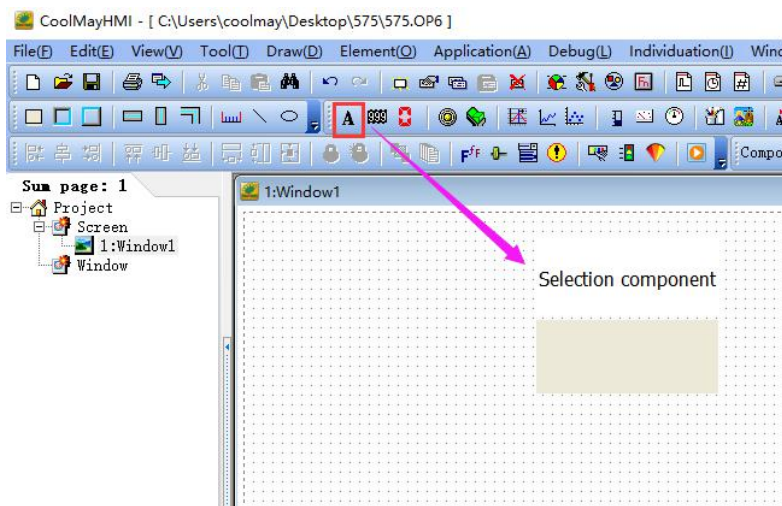



## II Text

Display text information, including Chinese characters. English letters.

Unicode character set.text attributions are as below:

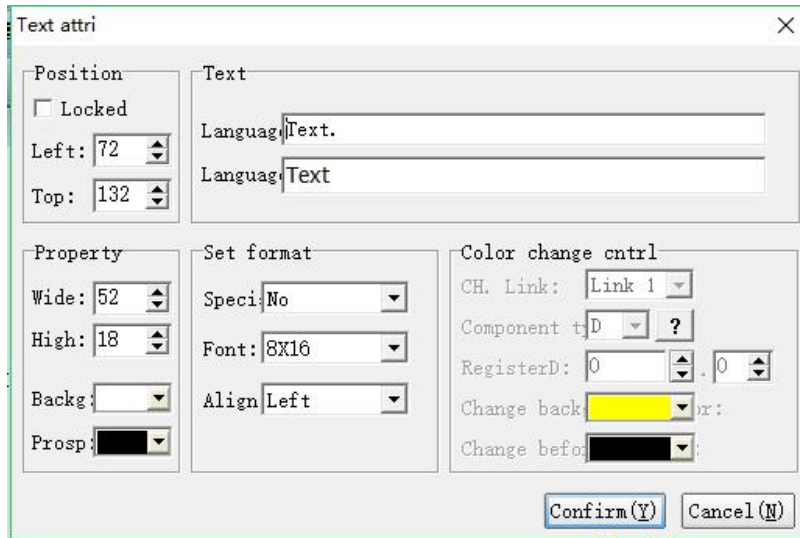

### ➤Position

Locked: Lock elements, prevent well-adjusted pages from accidentally damage.

Left: Coordinates of elements in the left page

Top: Coordinates of elements in the top page.

### ➤Property

Width: width of elements

Height: height of elements

Background: background color of elements

Foreground:foreground color of elements

### ➤Text Attribute

Language1 2 3 4 : Corresponding content which elements display when system language is selected “x”

### ➤Format Setting

Special: Select the background format of the component, background transparency, color control, and visibility control.

Font: Set the font size.

Align: Sets the alignment of the text to the component's outline.

### ➤Color change control

This option is highlighted and configurable when the special option in the format setting is selected for color change control and visibility control.

Channel connection: Select the communication channel.

Component Type: Select the object type of the object that is controlled for visibility.

Register Number: Set the address of the register.

Change background color: When the color change condition satisfies the background color of the rear part.

Changing the foreground color: When the color changing condition satisfies the foreground color of the rear part.

### ➤Examples:

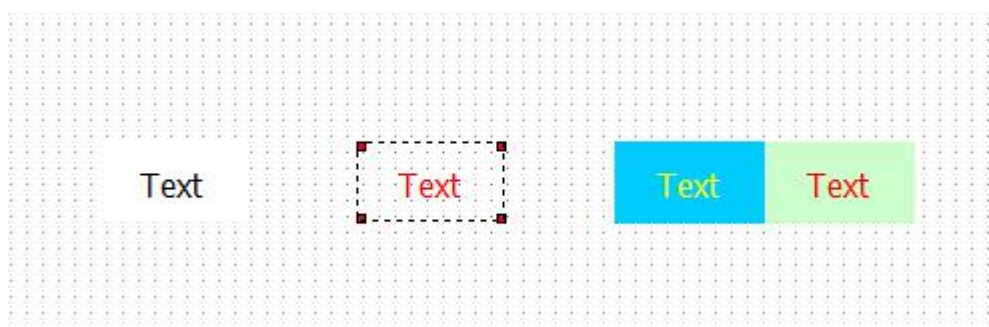

background transparent    without background transparent color  
changing conditions satisfied

### III Register

In the process of industrial control, the efficiency of the system can be reflected by the controller running parameters. Controller operations are displayed in the form of digital form is another advantage, which is an advantage of data presentation. Data input is to modify the parameters of the controller through HMI, it is another way of HMI connection.

#### ►Position

**Locked:** Lock elements, prevent well-adjusted pages from accidentally damage.

**Background transparency:** Check this function, the component background is transparent, that is, the background color is filtered out.

**Left:** Coordinates of the elements in the left page

**Top:** Coordinates of the elements in the top page.

#### ►Property

**Width:** width of elements

**Height:** height of elements

Background: background color of elements

Prospect: foreground color of elements

### ➤Registers

Channel connection: select communication channel.

element type: select element type

Register No.: set the address of registers

Data type: 16bit/32bit optional, SWAP indicates that the upper and lower bytes are interchanged.

Set Permit: register parameters can be set only when “permit” is set, otherwise it can only be displayed and cannot be modified.

Signed number: Registers can be displayed as positive and negative numbers when selected.

Zero leader: When selected, the register display starts with 0.

Direct upper and lower limits: Set the maximum and minimum values of the register data input, which are limited by the constant.

Indirect upper and lower limits: Set the maximum and minimum values of the register data input, which are limited by the values of other registers.

**Note:** If the data type is set to floating point number, the data set by the upper and lower limits contains the decimal point inside. For example, the number of digits is 5, the decimal place is 2, the upper limit is set to 65535, and the lower limit is 0. Then the maximum value of this register can be set to 655.35.

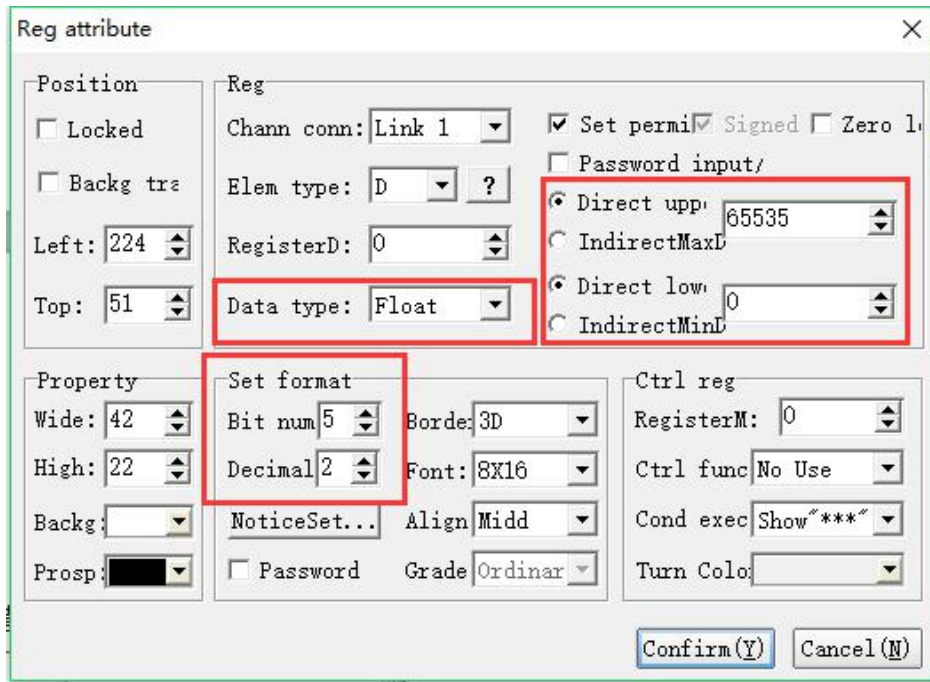

Offline simulation Display:

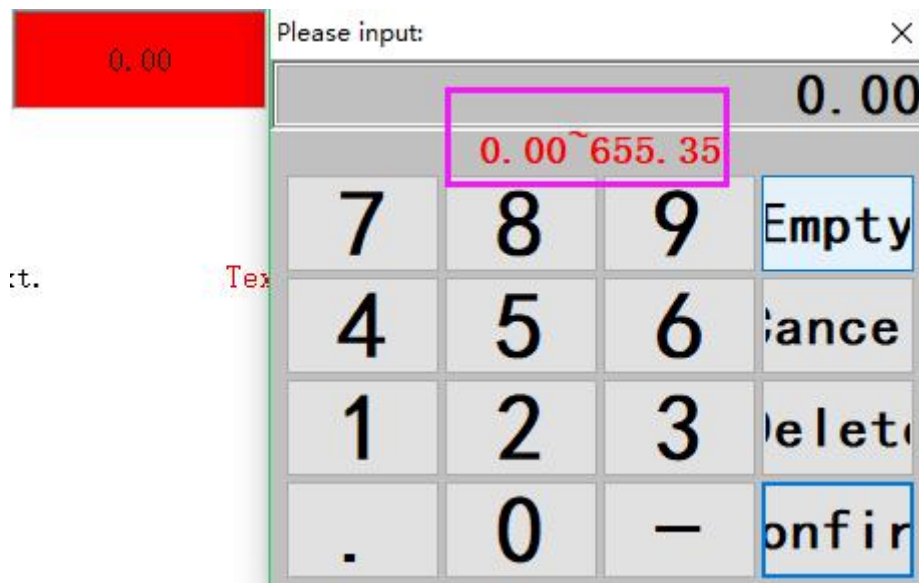

➤ **Set Format**

Bit number: the bits of the maximum setting and display of register

Decimal: set the decimal of the register

Notification setting: Set the relay action to be set when the register data

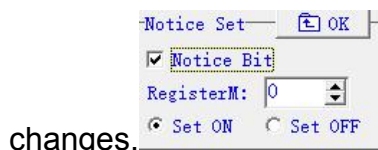

changes.

Background transparent: filter the background color

Password: only the correspond password be entered that the content of registers can be modified.

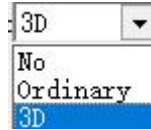

Border: select frame type

Font: set font size

Align: alignment of value and frame of elements.

Grade: levels of password protection, it is effective only when password protection is used.

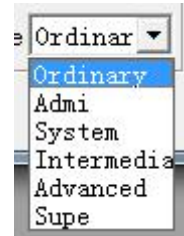

### ➤ Special- Register attribute

When register value meets the regulated conditions, this register will execute .

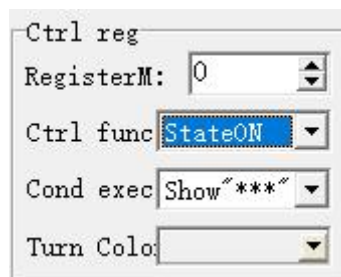

Above figure: When auxiliary contact M0=1, D0 will show\*\*\*\* .

### ➤ Examples:

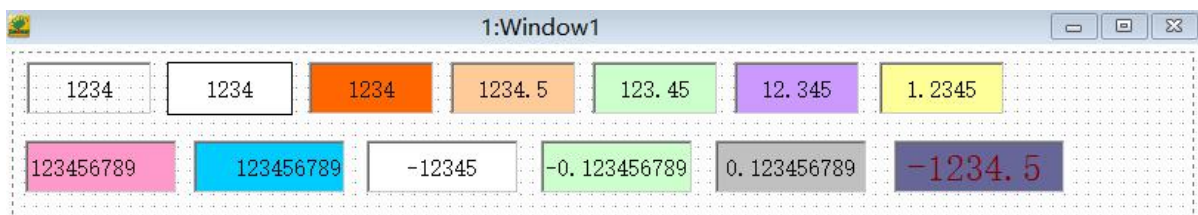

## IV Indicators

During operational process, in order to show clearly what operation the personal has made and the working conditions of devices, indicator light provide speedy prove of operation and testing.

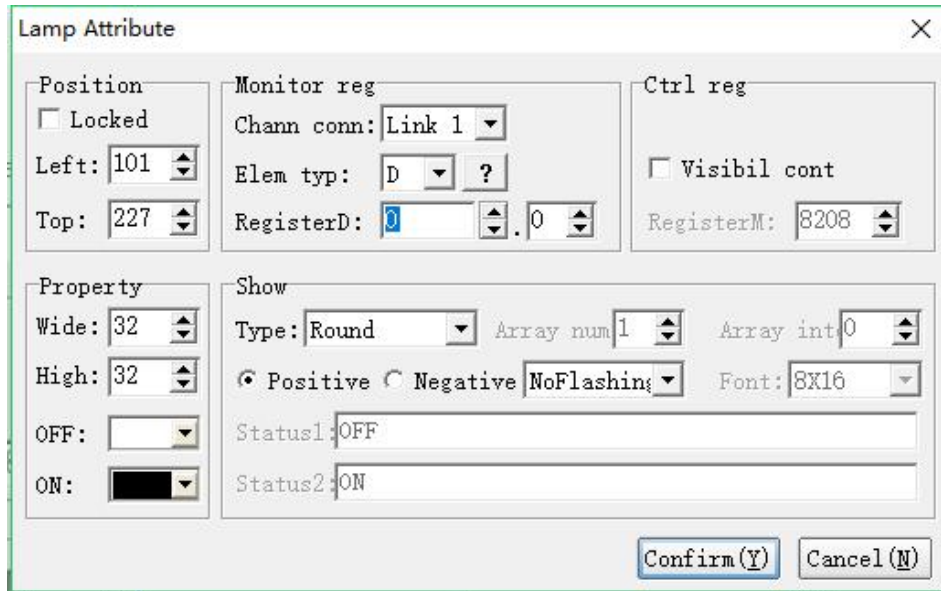

### ➤Position

Locked: lock elements, prevent well-adjusted pages from accidentally damage.

Left: Coordinates of the elements in the left page

Top: Coordinates of the elements in the top page.

### ➤Property

Width: width of elements

Height: height of elements

OFF: displayed color when indicator light is OFF

ON: displayed color when indicator light is ON

### ➤Register

Channel connection: select communication channel



Element type: choose element type

Register No.: Set register address

➤ Show

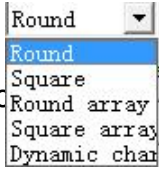
Type: Select the shape of the indicator  , select the status



picture, double click to select other indicator pictures:

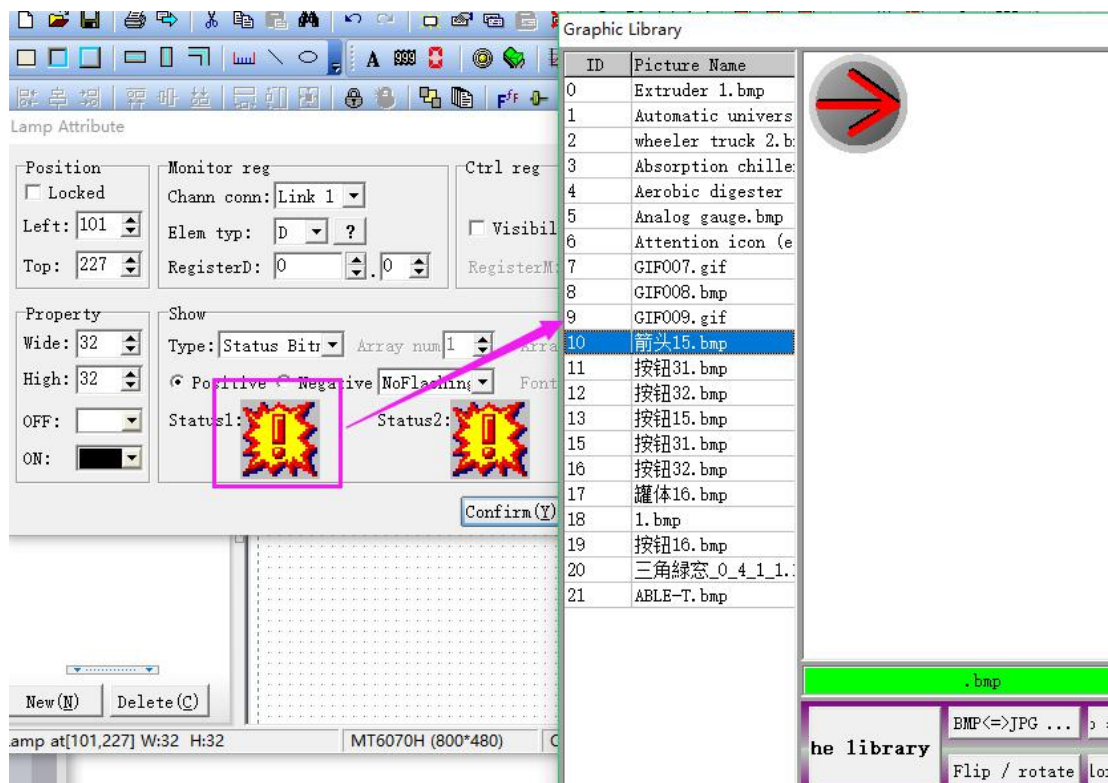

Positive logic: When indicator light is power off, display OFF color. When indicator light is power on, display ON color.

Negative logic: When indicator light is power off display ON color. When indicator light is power on, display OFF color.

Flash: set flicker interval or without flicker

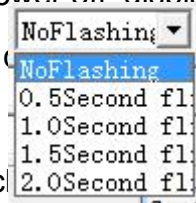

State 1 State 2: When the category is selected as a status character or a status picture, the corresponding characters and pictures can be set here.

➤ **Controlled register:** For example, display when set M5=ON

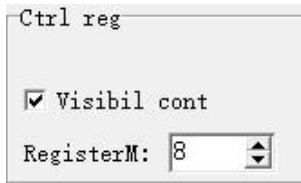

➤ **Examples:**

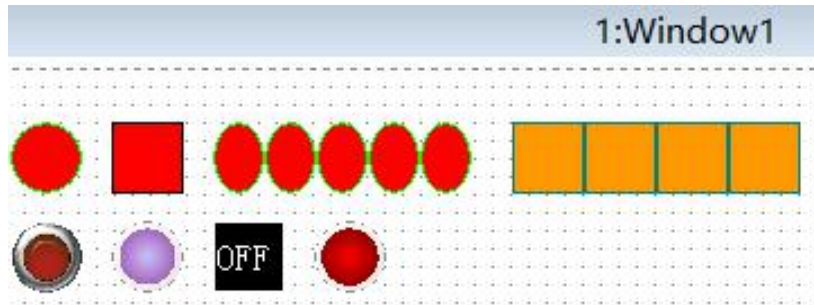

## V Bit operation switch

During operation, touch this button, HMI will immediately send out signals to PLC corresponding connection point ON or OFF.

There are four kinds of buttons for selecting: ON, OFF, alternative button, maintained button

### 1) Attribute of bit operation switch

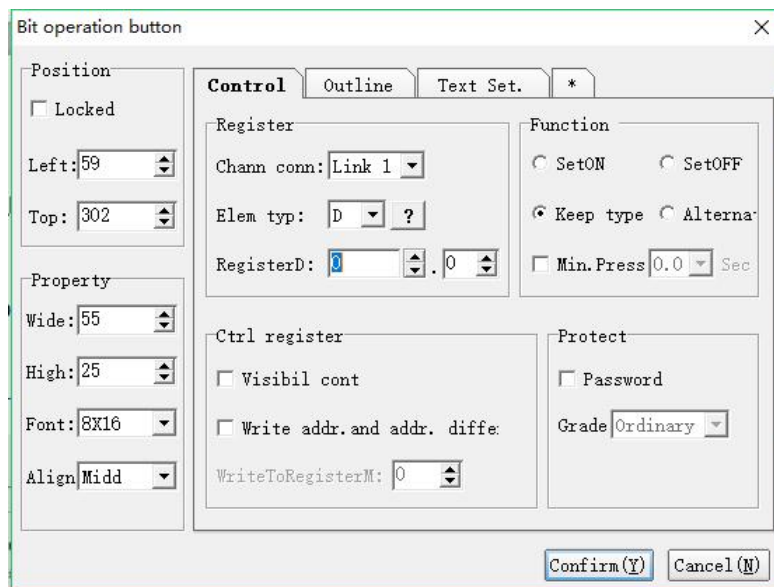

### ➤Position

Locked: lock elements, prevent well-adjusted pages from accidentally damage.

Left: Coordinates of the elements in the left page

Top: Coordinates of the elements in the top page.

### ➤Property

Width: width of element

Height: height of element

Font: set font size

Align: alignment of text and frame of element

### ➤Control Register

Channel connection: select communication channel

Element type: select element type

Register No.: Set register address

### ➤Control Function

Set ON : Press the contact to set it ON, hands away or repress , it is still ON.

Set OFF: Press the contact to set it OFF, hands away or repress , it is still OFF.

Alternative: Press the contact ON, it is still ON when hands away; it is OFF when repress it

In turn: Press the button, the contact is ON. It is still OFF when hands away.

### ➤Control Register

Visibility control: When checked, this button is visible when M0=ON is set in this example.



The write address is different from the monitor address: when checked, when the button is clicked, M0 is turned on or off; when M1 is turned on or off, the button reflects the M1 state.

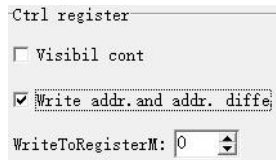

### ➤ Control Protect

Password: Only when correspond password being entered can this button be operated successfully

Grade: password protection, operations will be effective only under password protection condition .

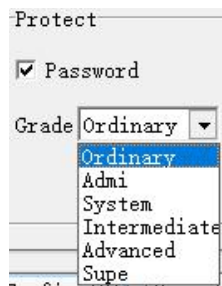

## 2) Attribute of bit operation switch II

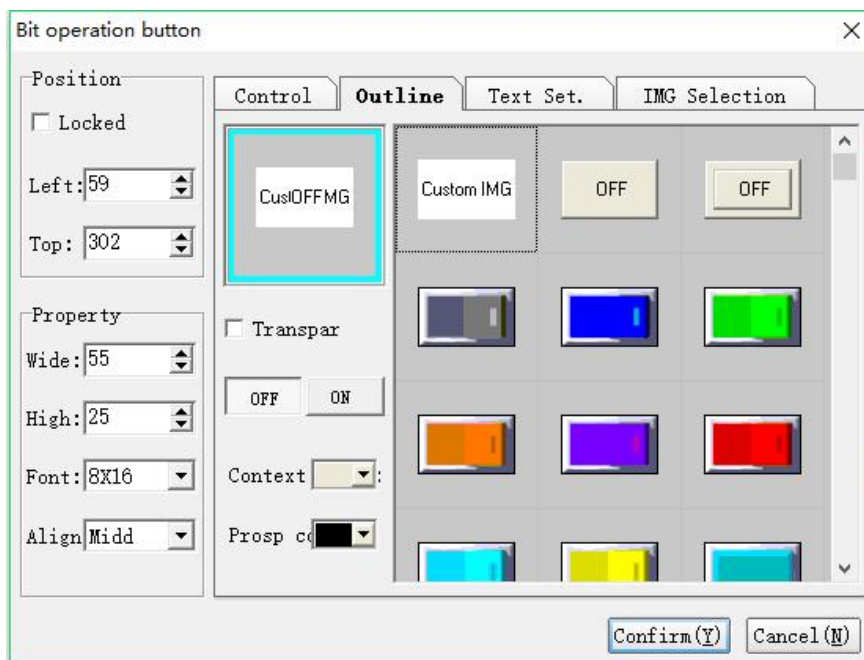

Control transparency: When checked, the button component displays a transparent state.

Background: The background color of the component.

Foreground: The foreground color of the component.

Shape of the position operation switch: Select the shape effect displayed when the switch is in the OFF/ON state.

CoolMay provides 21\*2 shape effects as below:

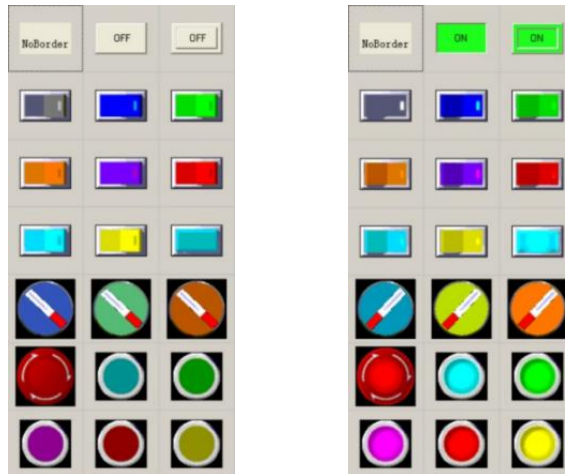

Select

, double click



, then add user-defined picture.

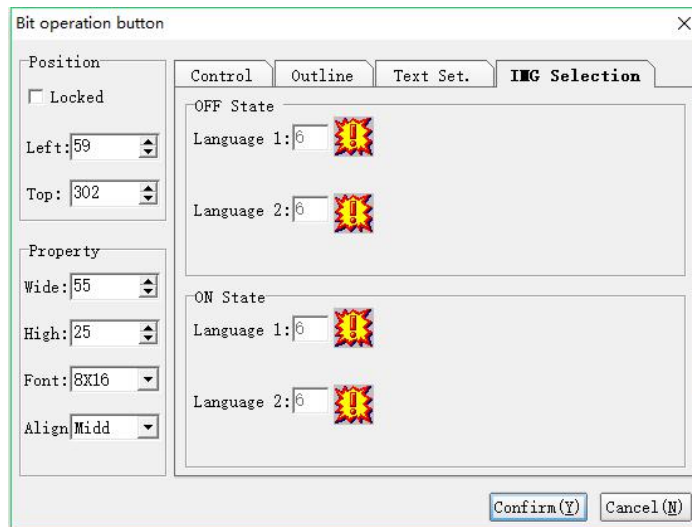

### 3) Attribute of bit operation switch III

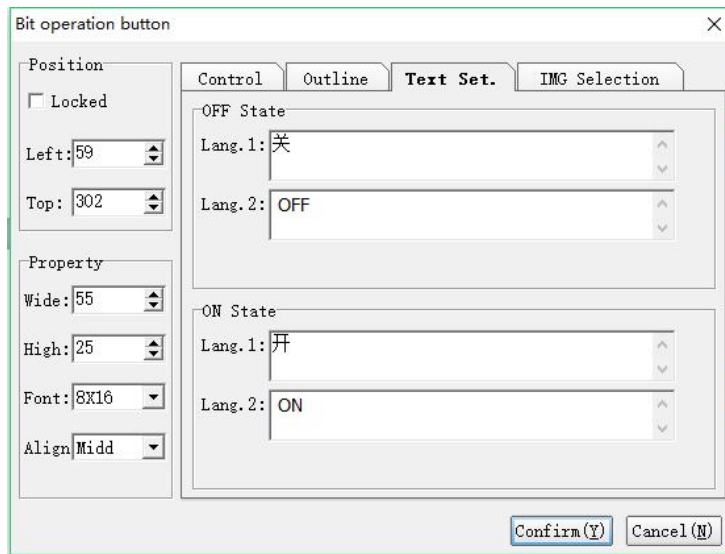

When select  the characters displayed when the switch is in the state OFF/ON are determined by these two following attributes.

#### ➤OFF state

Language 1 2 3 4: corresponding contents displayed by elements when system language is X.

#### ➤ON state

Language 1 2 3 4: corresponding contents displayed by elements when system language is X.

#### ➤Example:

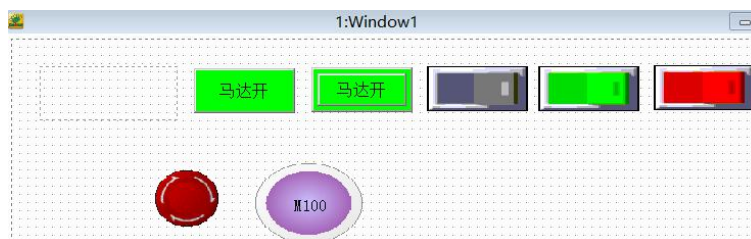

## VI Historical trend chart

(Only MT60 series touch screen supports downloading data)

Historical trend graph: HMI can set sampling time and conditions to read numeric data of buffers which is designated by PLC, and store these data in the record buffer of HMI. After everlastingly and chronically sampling, the data will be convert to curve and displayed on the screen of HMI.

### 1) Historical trend chart attribute

#### ➤ Position

Locked: Lock elements, prevent well-adjusted pages from accidentally damage.

Left: Coordinates of the elements in the left page



Top: Coordinates of the elements in the top page.

### ➤Property

Width: width of element

Height: height of element

Background: background color

Grid: color of grid

### ➤Basic

Record buffer #: Recorder buffer #(1~12) is a location which can temporarily store historic data. The location and capacity of recorder buffer must be defined firstly.

Buffer type : 16bit or 32bit optional

Transverse grid number: the amount of horizontal grids

Longitudinal grid number: the amount of vertical grids

Visibil cor. : When you set register \$W=0, the trend chart will display, on the contrary the trend chart will be hided.



## 2) Historical trend chart attribute **Curve 1..5**



5 curves can be displayed simultaneously in one historic trend chart

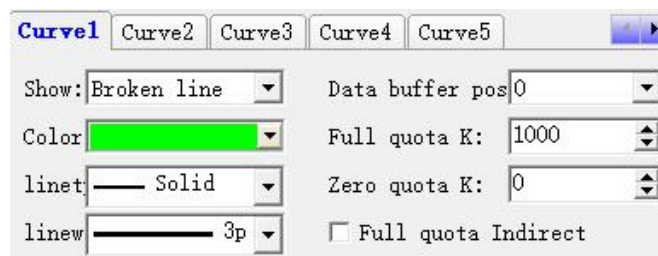

### ➤ Historical trend chart attribute Attribute of curve 1..5

Display: select whether use this curve and select the display mode.As shown

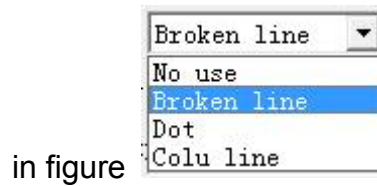

Color: color of curve

Line type: type of this curve, there are solid,dash and etc. As shown in



figure:

Line width:width of this curve, 1P to 6P optional. As shown in

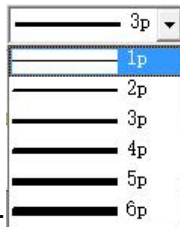

figure:

Data buffer position: This curve can show location of data origin in record buffer.

Show full quota: The maximum value showed by this curve, also it is the maximum value in Y axis. If data value is higher than this value, the maximum value will be displayed.

Show zero quota: The minimum value showed by this curve, also it is the minimum value in Y axis. If data value is lower than this value, the minimum value will be displayed.

Full Indirect Register: Check this function to display the full value using the data in the register.

### 3) Historical trend chart attribute Appearance

Curve4 Curve5 **Appearance** X Axis Y Axis

Not display grid

Do not display the X axis

Do not show Y axis label

Do not display the current co

Historical trend chart attribute

Position

Locked

Left: 64

Top: 40

Basic

Record buffer 1 Transverse 6 number:

Buffer number 16 Bit Longitudinal 3 number:

Visibil cor Register No, 0 = K 0

Property

Wide: 320

High: 180

Backg: 

Grid: 

Curve3 Curve4 Curve5 **Appearance** X Axis

Not display grid

Do not display t

Do not show Y ax

Do not display the cur

Confirm(Y) Cancel(N)

#### ➤ Historical trend chart attribute Appearance attribute

Do not display grid: select whether display grid

Do Not display X axis: select whether display annotation on X axis

Do not display Y axis: select whether display annotation on Y axis

Do not display the current value : select whether display the current value.

## 4) Historical trend chart attribute

X axis



➤ **Historical trend chart attribute** X axis attribute

Time format: select format of time displaying

Color: select color of time displaying

Font : select font of time displaying

## 5) Historical trend chart attribute Y axis



➤ **Historical trend chart attribute** Y axis attribute

Maximum coordinate: the maximum value on Y axis

Minimum coordinate: the minimum value on Y axis

Decimal number: the number of decimal on Y axis

marked number: the number of marked points on Y axis

Color marked : color of marked points on Y axis

Mark font: the font of marked points on Y axis

➤ Example:

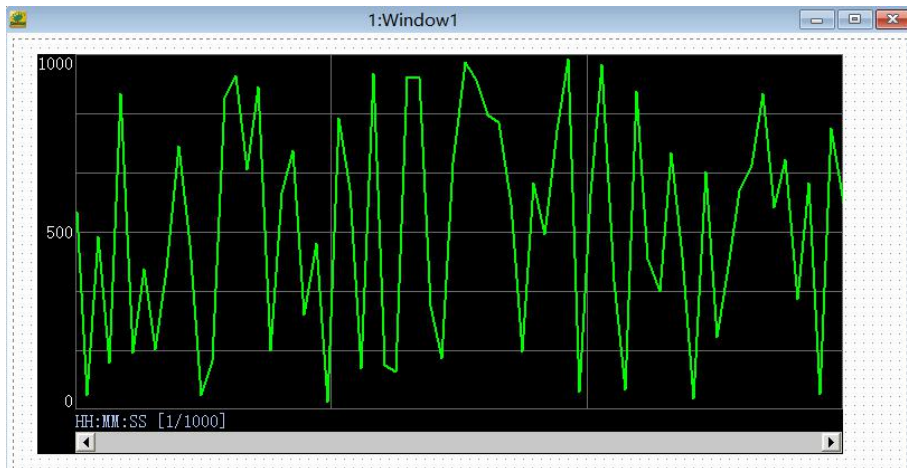

**Record buffer setting**

Set OP PRM

Alarm/Other    Figure/Language    **Record buffer**    Recipe setting

Buffer#	Sources D	Trigger flag	#ach	length	Total	sum	Auto	stop	Recording	in
<input checked="" type="checkbox"/> Record	10	<input checked="" type="checkbox"/> 0	5	10000			<input type="checkbox"/>	10	Sec.	
<input type="checkbox"/> Record	0	<input type="checkbox"/> 0	1	1			<input type="checkbox"/>	10	Sec.	
<input type="checkbox"/> Record	0	<input type="checkbox"/> 0	1	1			<input type="checkbox"/>	10	Sec.	
<input type="checkbox"/> Record	0	<input type="checkbox"/> 0	1	1			<input type="checkbox"/>	10	Sec.	
<input type="checkbox"/> Record	0	<input type="checkbox"/> 0	1	1			<input type="checkbox"/>	10	Sec.	
<input type="checkbox"/> Record	0	<input type="checkbox"/> 0	1	1			<input type="checkbox"/>	10	Sec.	
<input type="checkbox"/> Record	0	<input type="checkbox"/> 0	1	1			<input type="checkbox"/>	10	Sec.	
<input type="checkbox"/> Record	0	<input type="checkbox"/> 0	1	1			<input type="checkbox"/>	10	Sec.	
<input type="checkbox"/> Record	0	<input type="checkbox"/> 0	1	1			<input type="checkbox"/>	10	Sec.	
<input type="checkbox"/> Record	0	<input type="checkbox"/> 0	1	1			<input type="checkbox"/>	10	Sec.	
<input type="checkbox"/> Record	0	<input type="checkbox"/> 0	1	1			<input type="checkbox"/>	10	Sec.	
<input type="checkbox"/> Record	0	<input type="checkbox"/> 0	1	1			<input type="checkbox"/>	10	Sec.	

Confirm(Y)    plication    Cancel(N)

Buffer#: set location of record area

Source D: set the initial address of stored register, as shown in figure: the initial address is D8

Trigger flag#: set conditions for triggering, the address is a 32-bit register of the initial address of the fast reading area, as shown in figure:

Fast Read D: 8    Data leng 10

the triggering flag is 0, the initial address of fast reading area is D8, so the address of triggering flag is D8.0

Each Length: represents the quantity of registers being stored from data resource D (including the initial address of data resource D)

Example: store D10-D14 these five register

Total sum: total quantity of storage

Automatically stop: When selected, the system will stop automatically after recording the whole quantity, otherwise it will be covered automatically.

Record intervals: save data according to time intervals and the unit is second.

**Note: recording condition can only be trigger flag or record intervals.**

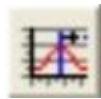

## VII Real-time trend chart

HMI can read continuous data of corresponding address and directly and real-time display them to users by figure. For example: If there are 50 points and you set 3 curves and then you can get 50X3, that is 150 word data and at meantime these data are processed in PLC program. Setting procedure can be referred to following figures, or you can download sample program from CoolMay official website.

## 1) Real time trend chart attribute

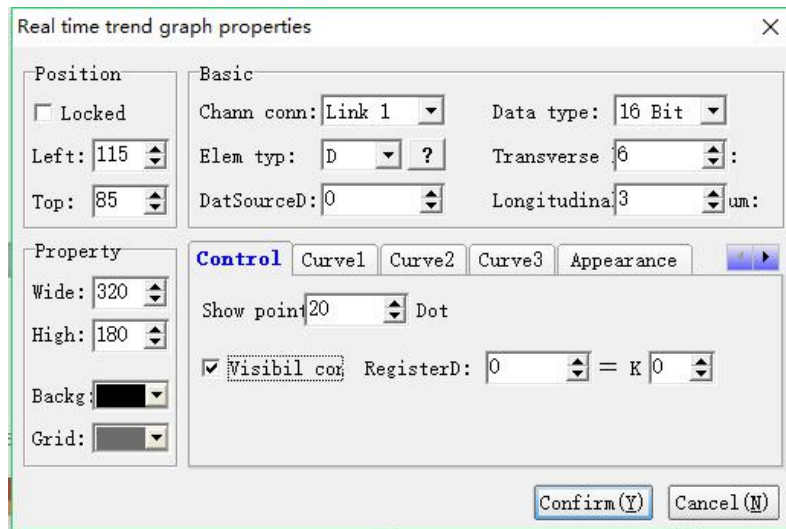

### ➤Position

Locked: Lock elements, prevent well-adjusted pages from accidentally damage.

Left: Coordinates of the elements in the left page

Top: Coordinates of the elements in the top page.

### ➤Property

Width: width of element

Height: height of element

Background: background color

Grid: color of grid

### ➤Basic attributes

Channel connection: select communication channel

Element type: select element type

Data resource: origin of collecting data

For example: If there are 50 display points, you can set 3 curves and address is D0, data type is 16bit, after these curves being triggered, there are 150 data being read. The location of Y axis in first curve is D0~D49, in second curve is D50~D99, in third curve is D100~d149. Another example: If there are 50



display points, you can set two curves and address is D0, data type is 32bit, after these curves being triggered, there are  $50 \times 2 \times 2 = 200$  data being read.

The location of Y axis in first curve is D0~D99, in second curve is D100~D199.

Data type: 16bit or 32bit

Transverse grid number: the amount of horizontal grids

Longitudinal grid number: the amount of vertical grids

### ► Control attribute

Show points: points of data reading and display points on trend chart.

Clear triggered ID: When page send a matched ID, curve will be eliminated.

Examples please refer to function key.

Visibility: When set register = Kxx, the chart will be displayed, otherwise the chart will be hidden.

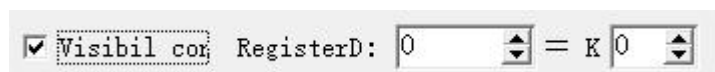

### 2) Real time trend chart attribute Curve1...3

Three curves can be displayed in historic trend chart at the same time

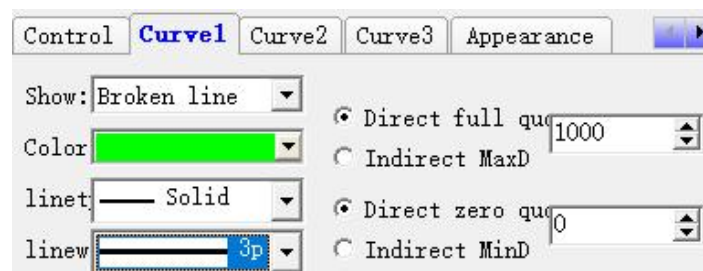

### 3) Real time trend chart attribute Curve1. ..3

Display: select whether to use this curve and select the display mode

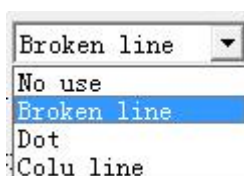

Color: color of this curve

Line type: type of this curve, for example: solid,dash and etc. As shown in

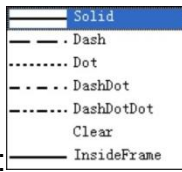

figure:

Line width:width of this curve, 1P to 6P optional. As shown in

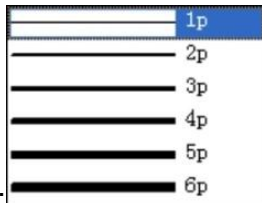

figure:

Full quota: The maximum value showed by this curve, also it is the maximum value in Y axis. If data value is higher than this value, this maximum value will be displayed.

Zero quota: The minimum value showed by this curve, also it is the minimum value in Y axis.

If data value is lower than this value, this minimum value will be displayed.

Indirect full credit value D: Indicates that the maximum value of the curve uses the data in the set register.

Indirect zero credit value D: Indicates that the maximum value of the curve uses the data in the set register.



### 3) Real time trend chart attribute. Appearance

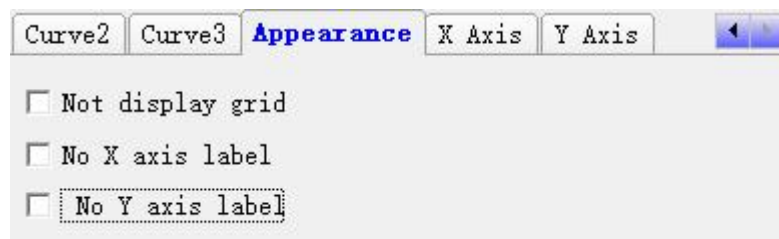

➤ **Real time trend chart attribute** Attribute of appearance

No not display grid: select whether display network

No not show X axis: select whether display annotation on X axis

No not show Y axis: select whether display annotation on Y axis

#### 4) Real time trend chart attribute X axis

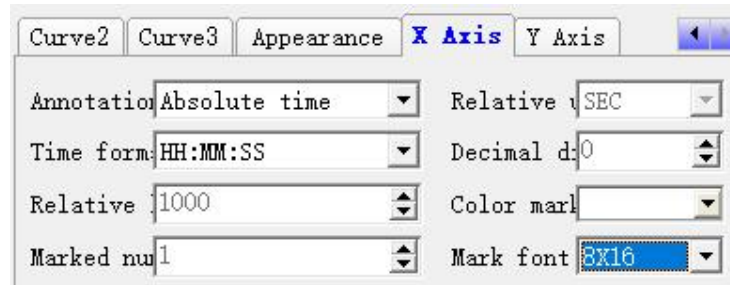

#### ➤ Real time trend chart attribute X axis attribute

Annotation: absolute time and relative value

Time format: format of displayed time, effective only when “absolute time” is selected.

Relative longitude: Relative longitude of time displaying, effective only when “relative time” is selected

Marked number: number of displayed annotations

Relative unit: Relative unit of time, effective only when “relative time” is selected

Decimal digits: Decimal digits of time displaying, effective only when “relative time” is selected

Color marked: Color of time displaying

Mark font: Font size of time annotation

#### 5) Real time trend chart attribute Y axis

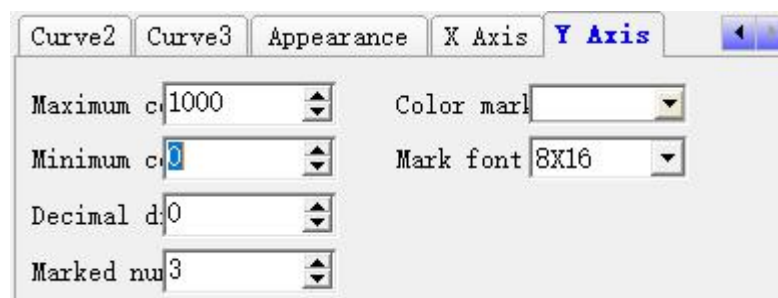

Max. Coodinate: the Max. Value that Y axis annotation

Min. Coodinate: the Min. Value that Y axis annotation

Decimal Digits: decimal digits that Y axis annotation

Marked number: quantity of Y axis annotation

Color marked: color of Y axis annotation

Mark font:font size of Y axis annotation

Set two curves which record analog D50 and D51. The first curve record D50, occupying 50 register from D100-D149, the second curve record D51, occupying 50 registers from D150-D199. Program settings of HMI and PLC are as below, please download detailed sample program from the official website.

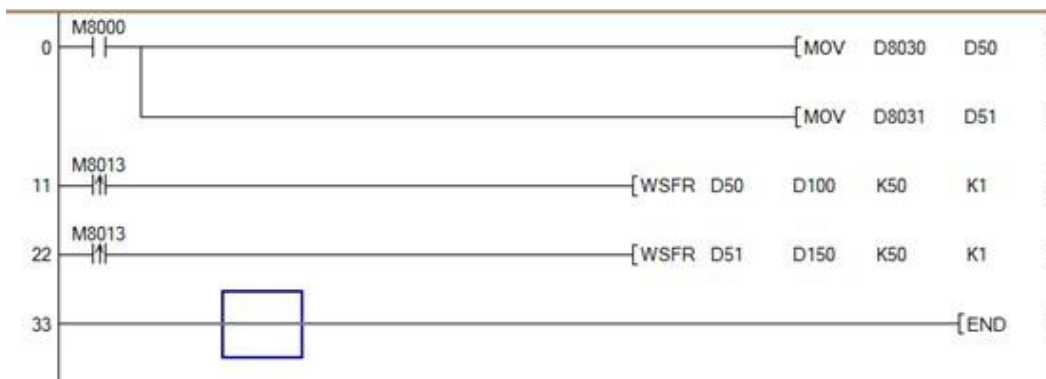
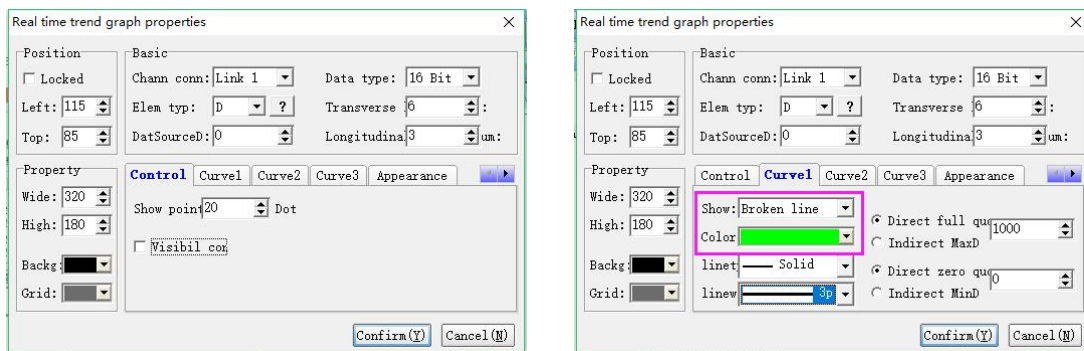

## VIII Bar graph

Bar graph is another form to display digit which can display data of analog such as temperature, pressure, flow and so on. Bar chart can show data by percentage way according to full and zero quota. Height and width can be

designated optional

### ➤Position

Locked: lock elements, prevent well-adjusted pages from accidentally damage.

Left: Coordinates of the elements in the left page.

Top: Coordinates of the elements in the top page.

### ➤Property

Width: width of elements

Height: height of elements

Background: background color

Prospect: foreground color

### ➤Register

Channel connection: select communication connection

Element type: choose type of elements

Register : set register's address

Data type: select 16bit or 32bit

Show form: the direction of bar chart changes when the value of register gets larger, for example: up, down, left and right.

Display padding image: Padding image of bar chart as shown in

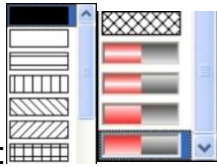

figure:

### ➤ Control

Full quota: The maximum value which bar chart can display

Zero quota: The minimum value which bar chart can display

Indirect full credit D: indicates that the maximum value of the bar graph uses the data in the set register.

Indirect zero degree D: indicates that the minimum value of the bar graph uses the data in the set register.

### ➤ Controlled register attribute

Visibility Control: Check this function to indicate that the display and hiding of the bar graph requires a set of relays to control.

The legend shows that when the relay M10 is ON, the bar graph is visible.

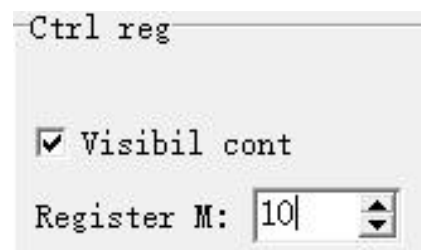

Examples

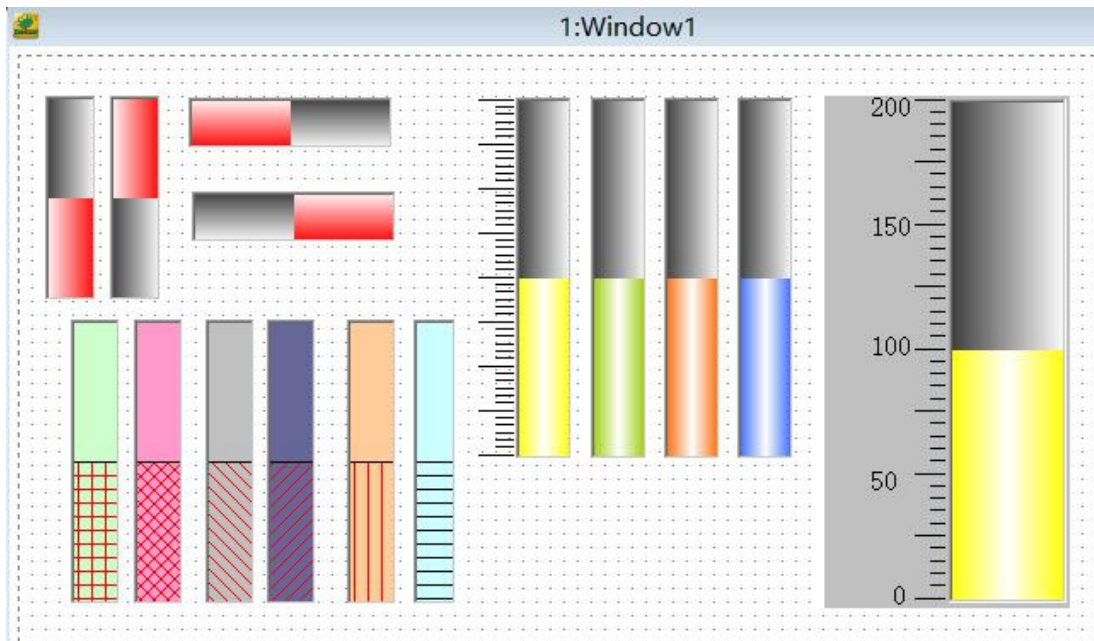

IX Meter 

Meter is another form to display digit which can display data of analog such as temperature, pressure, flow and so on.

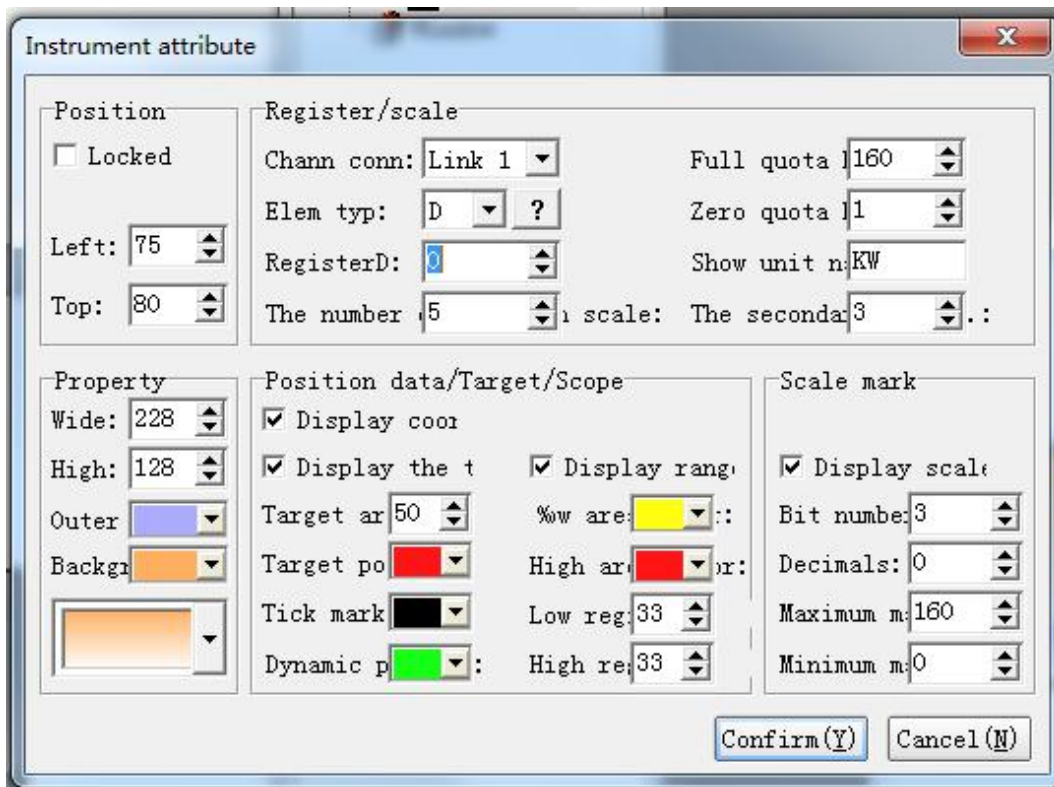



**➤Position**

Locked: lock elements, prevent well-adjusted pages from accidentally damage.

Left: coordinates of the elements in the left page

Top: coordinates of the elements in the top page.

**➤Property**

Width: width of elements

Height: height of elements

Outer: frame color

background: background color

**➤Register /scale**

Channel connection: Select the communication channel.

Component Type: Select the object type.

Register Number: Set the address of the register.

Full credit value K: The maximum value represented by the meter pointer.

Zero credit value K: The minimum value represented by the meter pointer.

Display unit name: Set the name of the display unit.

Major ticks: The number of major scales.

Minor scale: The number of scales assigned to each major scale.

**Position data/Target/Scope**

Axis, mark range and target pointer can be selected not to display. When not displayed, their correspond attributes can not be used.

Target area: area displayed by target point

Target pointer: color of target pointer

Tick mark: color of scale mark

Dynamic pointer: Dynamic pointer color.

Low area color: color in low area

High area color: color in high area

Low area: percentage of low area

High area: percentage of high area

### Scale mark

When scale mark is not selected, the relevant attribute can not be used.

Bit number: The maximum digit of scale mark.

Decimals: decimals of scale mark .

Maximum mark: The maximum number of scale mark.

Minimum mark: The minimum number of scale mark.

### Examples:

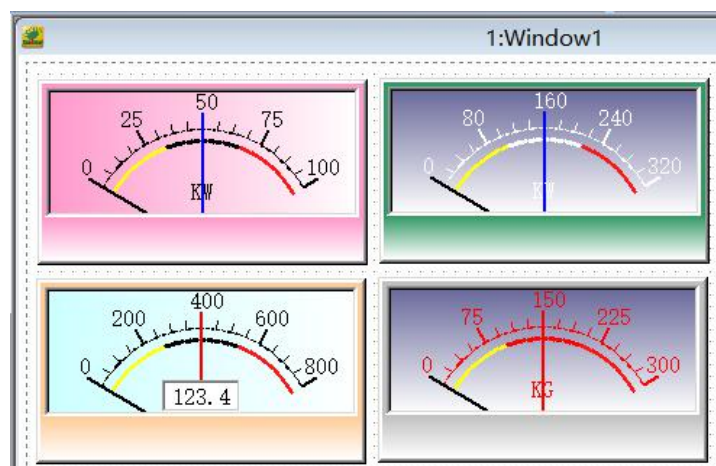

### X Picture

Picture element is bitmap which can show the figure of machine so that operators can understand easily . Also, the bitmap can show factory logo and emblem to enhance product identity. Picture state and absolute location are controlled by three registers.

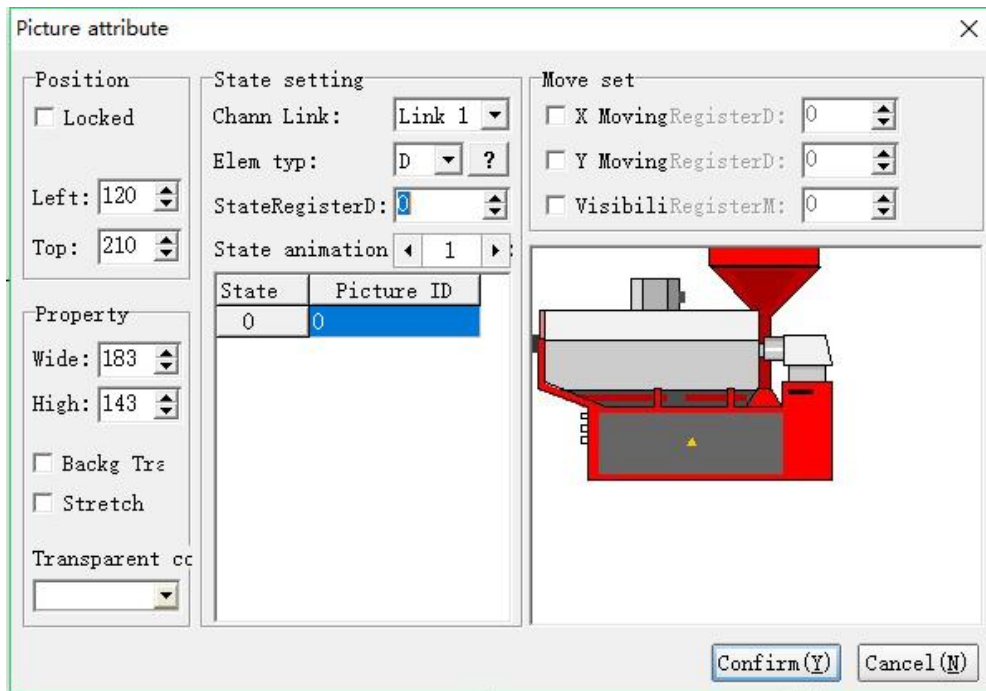

### ➤ Position

Locked: lock elements, prevent well-adjusted pages from accidentally damage.

Left: coordinates of the elements in the left page

Top: coordinates of the elements in the top page.

### ➤ Property

Width: width of elements

Height: height of elements

Background transparent : filter the transparent color which has already been selected

Stretch: when selected, images can automatically adjust width and height which has already been set.



Transparent color: select transparent color, also can be selected by color selection device

### ➤ State setting

Channel connection: select communication channel

Element type: select element type

State register D: display corresponding picture according to the value of register

State animation number: increase or decrease the number of animation through the buttons  and .

### ➤Move

X moving: when selected, elements can horizontally move along the X axis. When the register value increase or decrease 1, the element will move one pixel towards the left or the right.

Y moving: when selected, elements are used as Y-axis vertical scroll. When the register value increase or decrease 1, the element will move one pixel towards the left or the right.

Visibility: when auxiliary contact M is driven ON, the element will display. When driven OFF, the element will be hidden.

## Ways of extracting picture

CoolMay provide two ways for extracting picture, as figure shows:

- 1) Double click the state to choose pictures

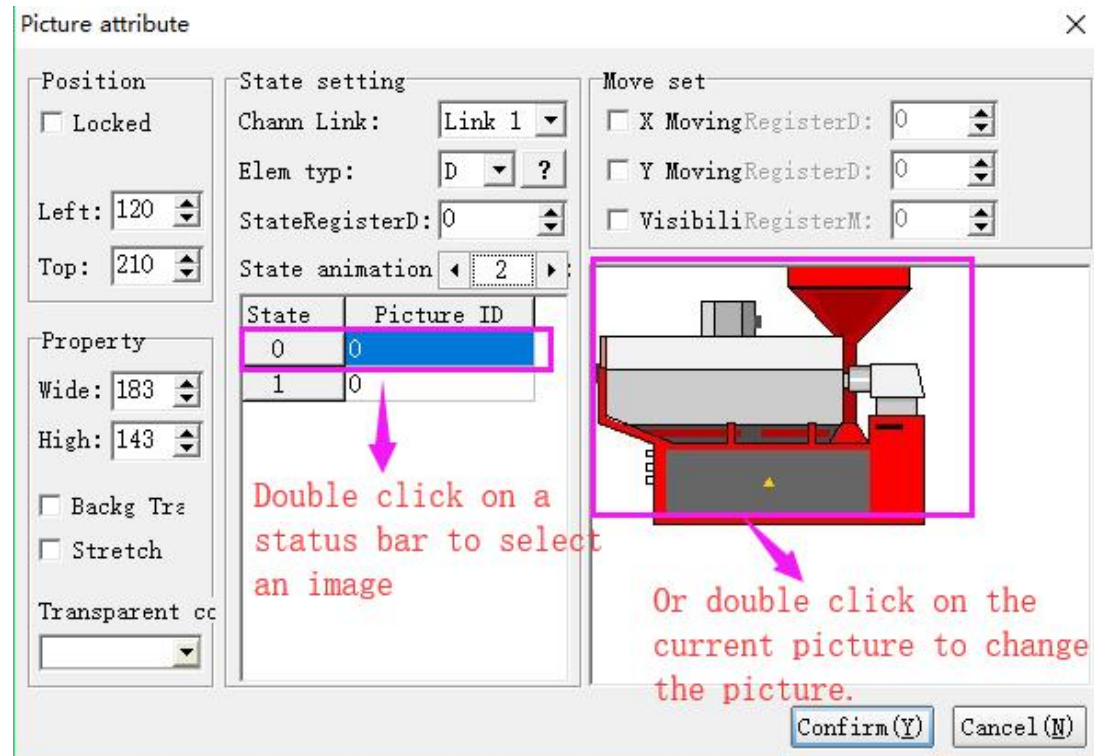

2) Right click the mouse of current picture for replacement

### Graphic library

After selecting one of these two ways to extract picture, CoolMay HMI will pop-up picture library dialog box, which provide some functions such as selection, addition, derivation, substitution, deletion, conversion from BMP to JPG, overturn/rotation, color transposition, stretch, compressed graphic library.

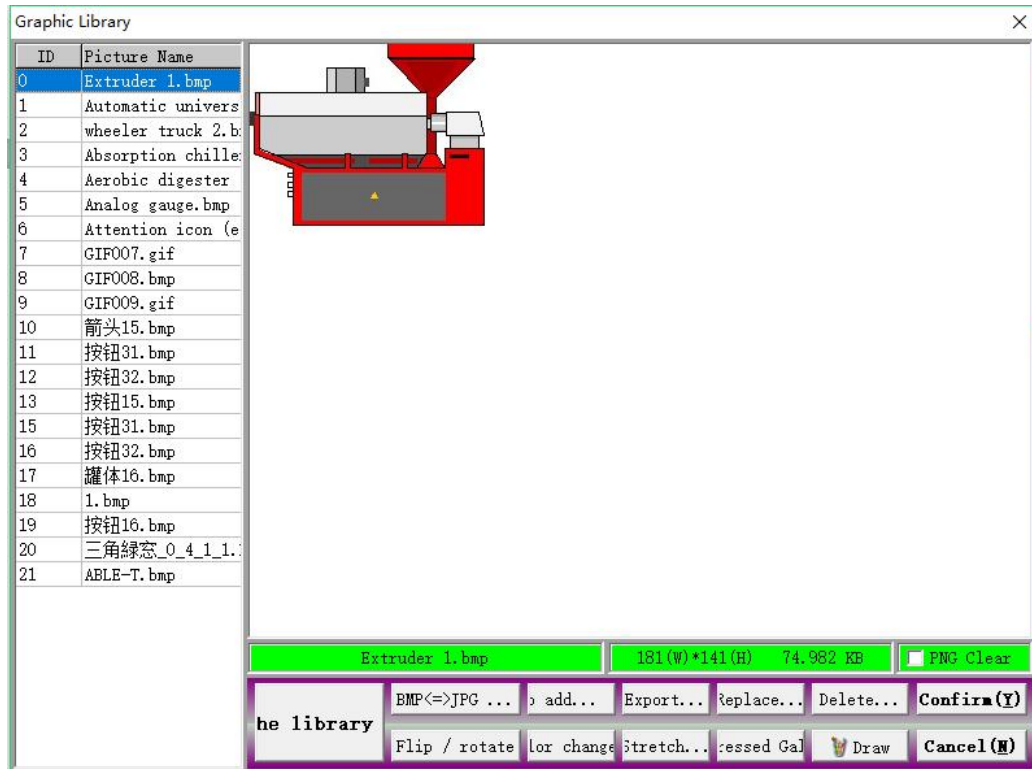

Added by the gallery, showing the gallery as shown:

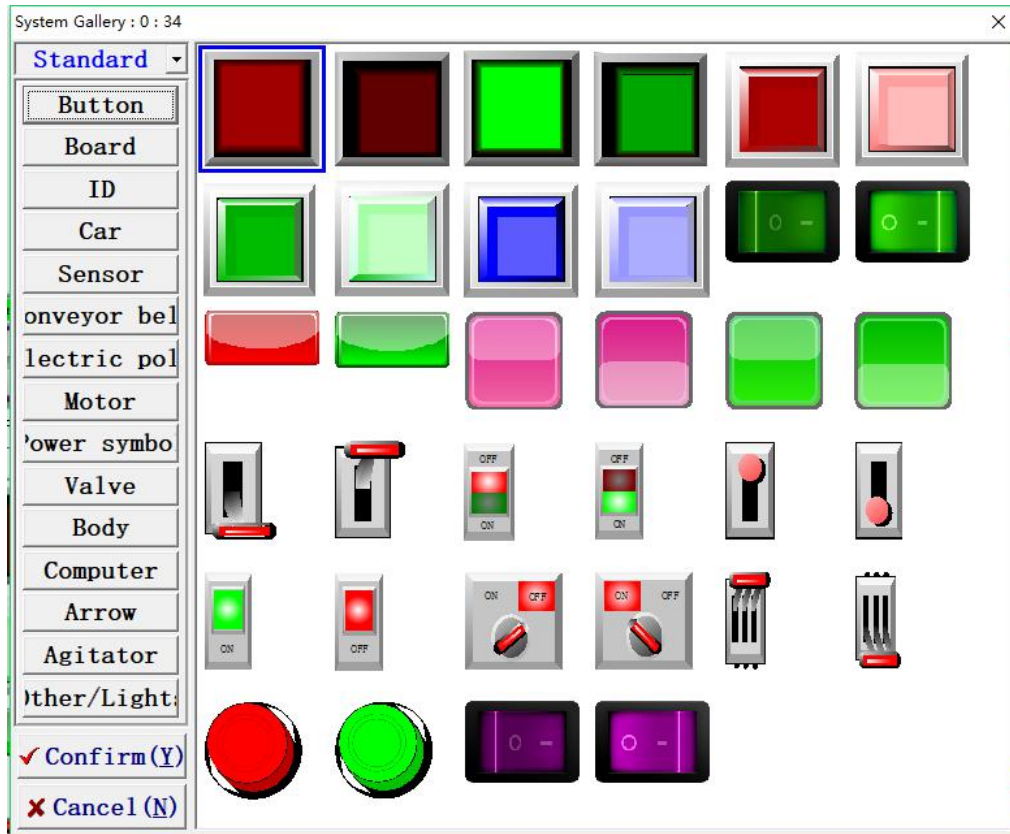

Click "Add" to add an external image directly:

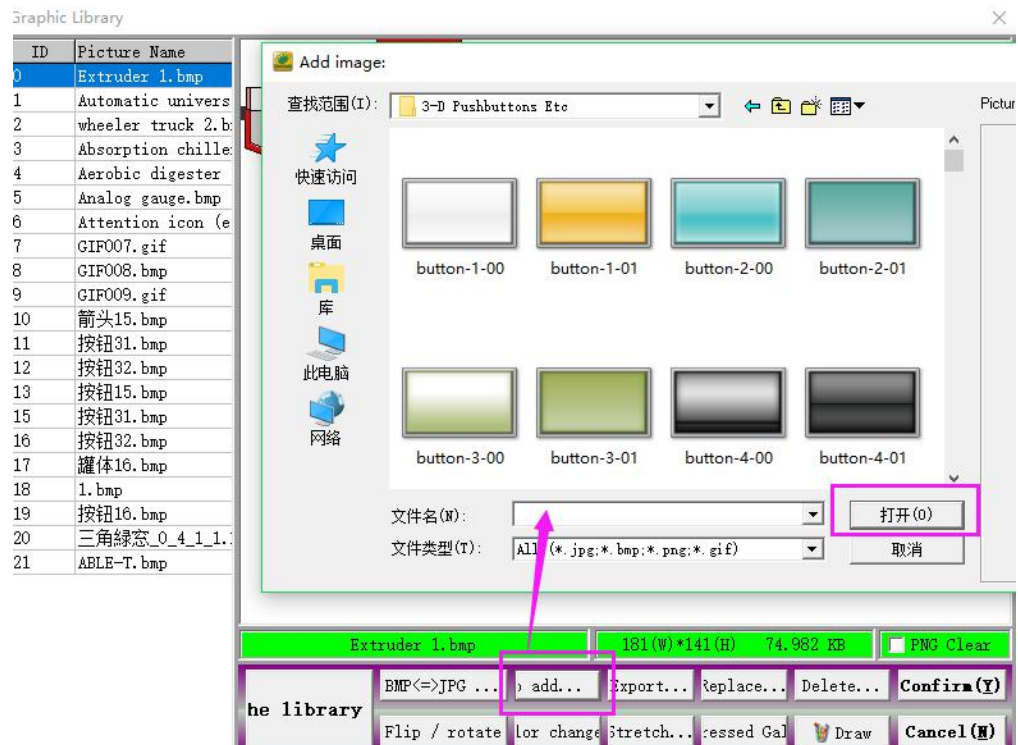



## XI GIF Animation Components

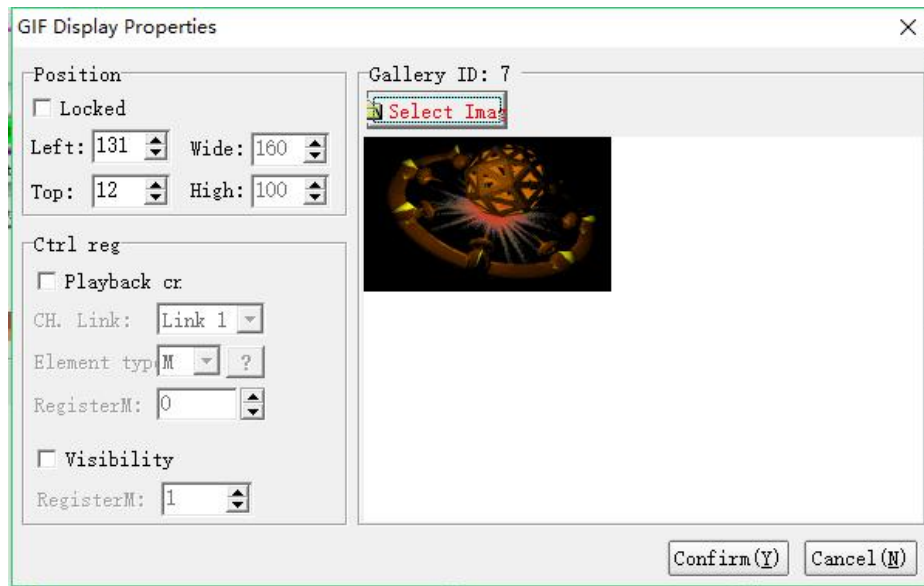

### ➤ Location attribute

Move Lock: Locks the component to prevent the layout from being accidentally damaged.

Left: The coordinates of the page at the far left of the component.

Top: The top of the component is at the coordinates of the page.

Width: The width of the component.

Height: The height of the component.

### ➤ Controlled register attribute

Playback Control: Checking this function means that when playing a movie, it is controlled by the set register.

Channel connection: Select the communication channel.

Component Type: Select the object type.

Register number: Plays the animation when the value of the register reaches the condition.

Visibility: When the setting M of the set register is ON, the animation is displayed. When it is OFF, the animation is hidden.

### ➤ Gallery ID: 7 attributes

Animated image: Click this button to make the desired animation.

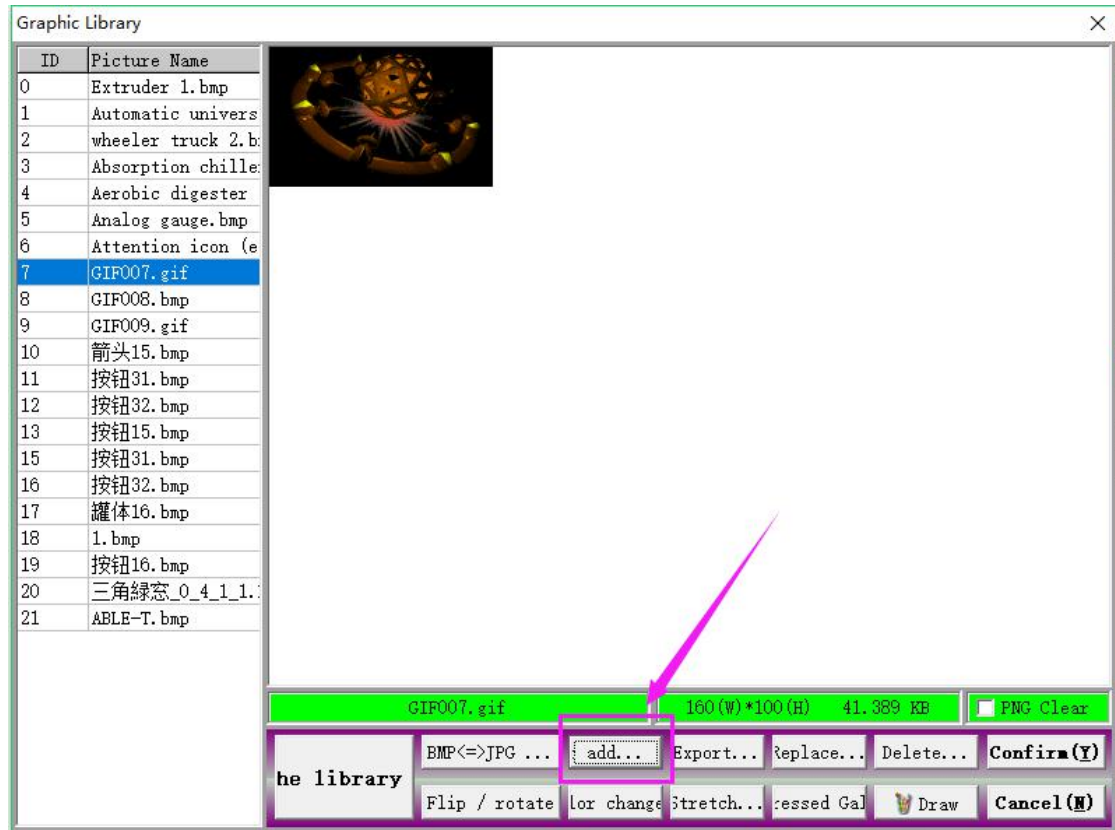

## XII Dynamic text

During industrial control, there are more than one conditions when machine is working. GIF Viewer can display different working conditions which is the most ideal choice.

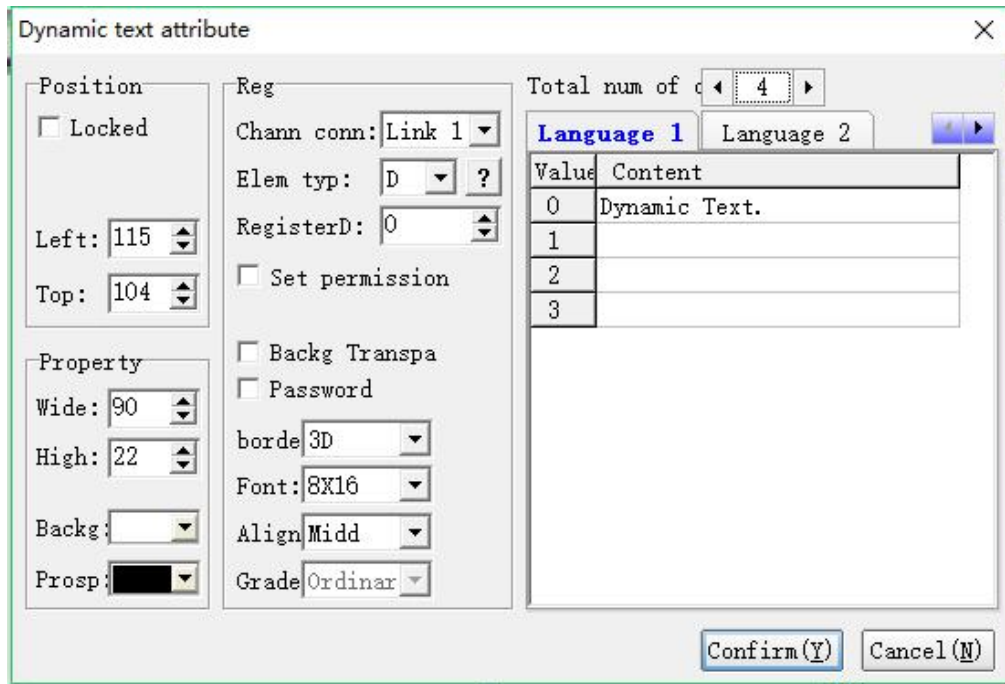

### ➤Position

Locked: lock elements, prevent well-adjusted pages from accidentally damage.

Left: Coordinates of the elements in the left page

Top: Coordinates of the elements in the top page.

### ➤Property

Width: width of elements

Height: height of elements

Background: background color

prospect:foreground color

### ➤Register

Channel connection: select communication channel

Element type: select type of element

Register D: set register address

Set permission: controlled by keyboard. When selected, the data will be

usually sent by keyboard to PLC, otherwise it will show text according to data from PLC, like action prompt and alarm prompt.

Focus from zero forcibly: effective when “set permission” is selected. Data in register will be deleted when cursor of keyboard left

Background transparent: filter color of background



Password : When selected, password protection will be effective

Border: display the type of frame

Font : font size

Align:alignment of text and element’s border

Grade: password grade. Effective only when “password” is selected.

Total number of state changes: Reduce and increase the amount of text change by using the  and  buttons.

### ➤Language

Language 1: Select the corresponding text that the language displays at one time.

Language 2: The corresponding text displayed when the language is selected.

Language 3: Select the corresponding text displayed when the language is three.

Language 4: Select the corresponding text displayed when the language is four

### ➤Function

Special: When “key register”meets the required conditions, the corresponding operations will be executed.

As shown in the above figure: When M0=ON, the dynamic text string will

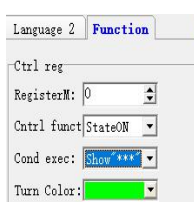

display

### ➤ Modify record setting

Explanation: The amendant record "Modify Project" will send to the system when users modify the element

Language: corresponding contents displayed by elements when system language is X.

### ➤ Status display

数值	内容
0	机器运转正常
1	手动运行中
2	半自动运行中
3	电眼自动运行中
4	时间自动运行中
5	安全门未关
6	请开安全门
7	安全门故障
8	关模未定时完成
9	开模未定时完成
10	储料未定时完成
11	低压保护时间到

数值	内容
0	Machine run normally
1	Runing in manual mode
2	Runing in semi-auto mode
3	Runing by electric eye
4	Runing by time
5	Safety door open
6	Open safety door
7	Safety door fault
8	M. C. not finished on time
9	M. O. not finished on time
10	Melt not finished on time
11	Low pres. time Limited

As shown above:

When the system language is the language, the text displays "The machine is running normally" when the corresponding register is equal to 0. When the value is equal to 1, the text displays "Manual running". When it is equal to 2, the text displays "Semi-automatic running". When the system language is language 2, the text displays "Machine run normally" when the corresponding register is equal to 0. When the value is equal to 1, the text displays "Runing in manual mode". When it is equal to 2, the text displays "Runing in semi-auto mode"... ..



### XIII Function Key

The function key is collection of all key functions. Functions can be set to buttons so that they can execute different functions.

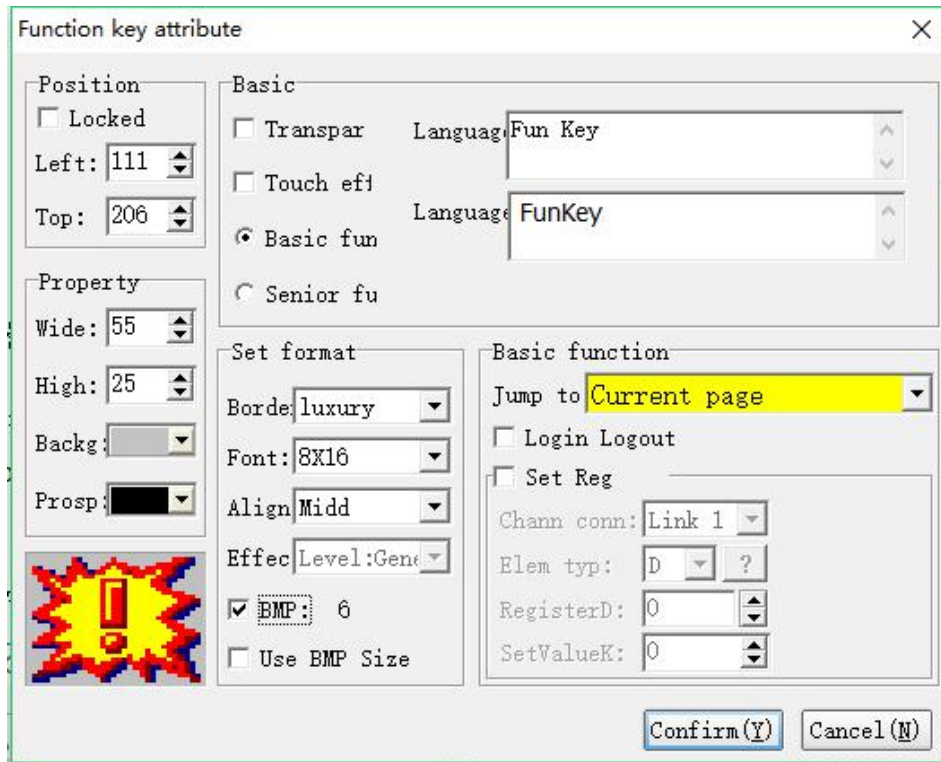

### ➤ Location

Locked: lock elements, prevent well-adjusted pages from accidentally damage.

Left: coordinates of the elements in the left page

Top: coordinates of the elements in the top page.

### ➤ Property

Width: width of elements

Height: height of elements

Background: background color

Foreground: foreground color

Picture: Check the picture and double-click  to set the function key to another picture.

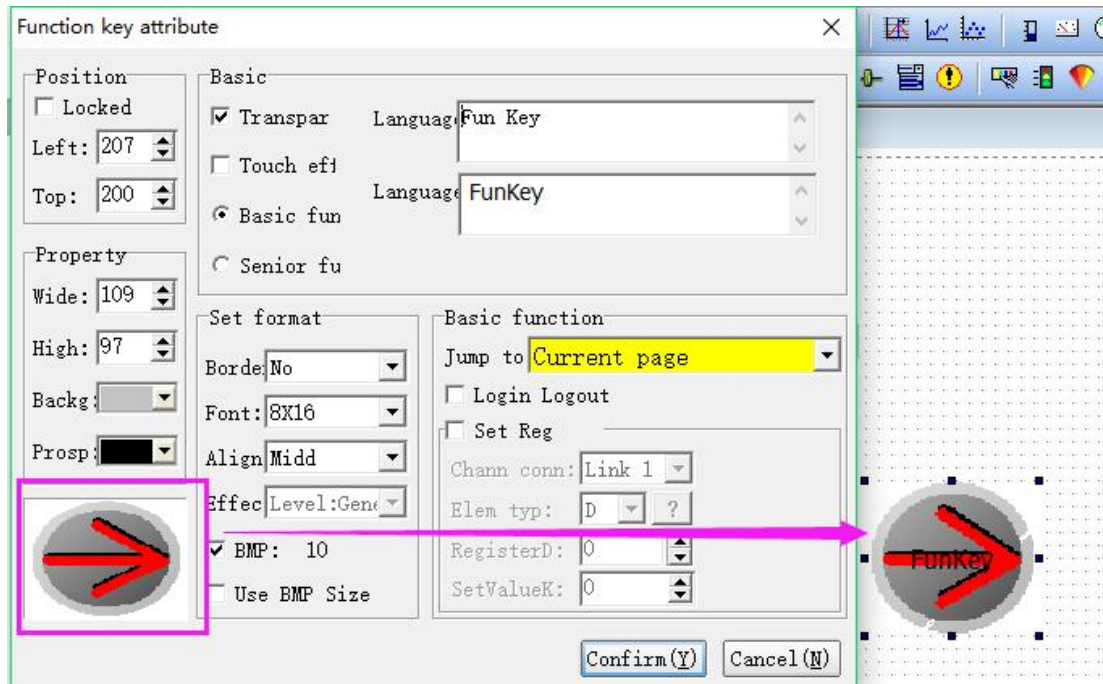

### ➤ Basic property

Control transparency: Check this feature, the component is transparent.

Touch is valid: Check this function. When using this component, you need to enter the corresponding level password.

Language 1, 2, 3, 4: When the system selects the language "x", the corresponding content is displayed.

### ➤ Format setting

Border: border type

Font: font size

Align: alignment of text and element's border

Grade: password grade, effective only when "password" is selected.

### ➤ Basic skills

When using function key components, you can only choose one of the basic functions and advanced functions.

Basic functions: including screen jump, USB screen, user configuration screen,



PC diagnostic screen, Ethernet/CAN configuration screen, system menu screen.

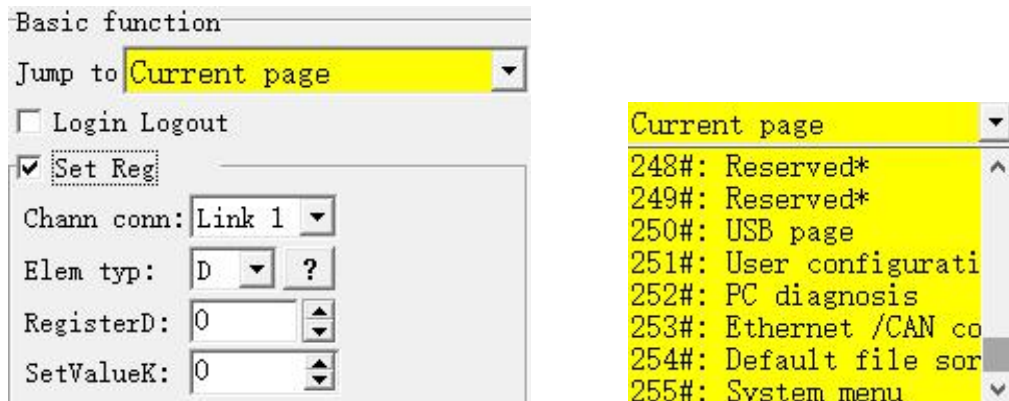

**Logout Login:** When this function is checked, the password will be logged out after entering the password. If this function is not checked, the password will be retained after entering the password, but only for 6 minutes (screen save time set by the touch screen). After 6 minutes, need to enter the password again.

**Setting register:** When this function is checked, the function register can be notified to set the status when the function key is clicked.

### ➤ Advanced Features

**Advanced features:** including sending messages, uploading and downloading data to USB, password login and logout, system data backup and restore and clear, screen brightness adjustment, voice volume adjustment, language conversion, recipe function, etc...

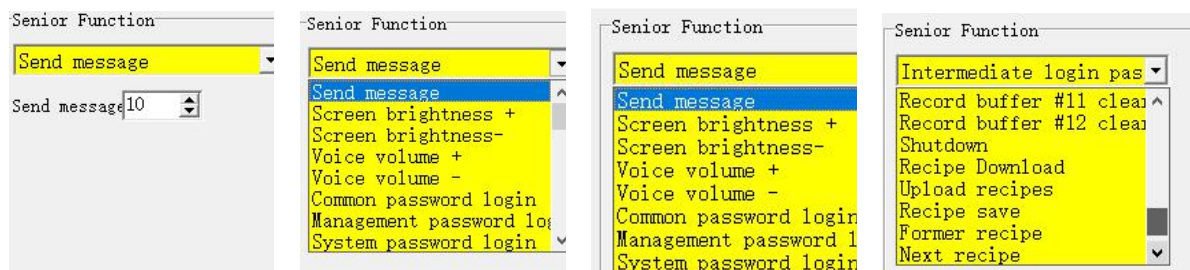

The sending message also assigns an ID of the sending message for sending a signal to the set ID. For example, the following figure is a list of alarm records. The sending message of the function key is set to ID=300, and all the clearing

trigger messages of the alarm record list are ID 300. When the function key is pressed, the alarm record list will execute “all record number clearing”; as shown below:

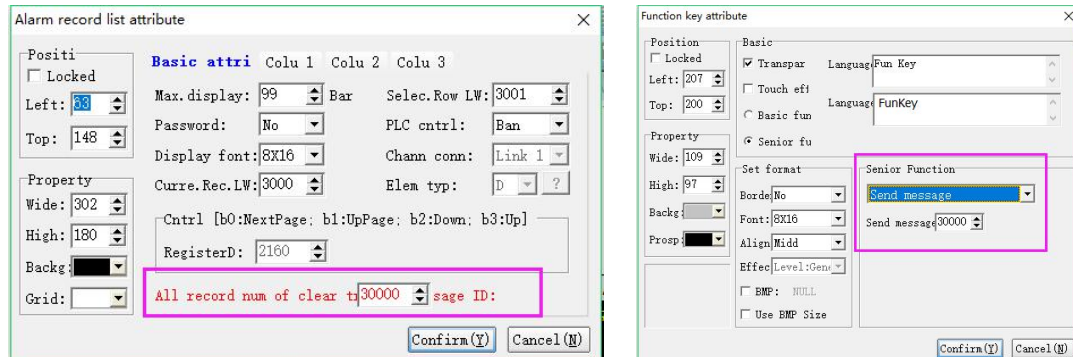

#### XIV Variable text

Variable text can enter and display letters, characters, numbers and Chinese characters. Similar to input data, when you enter characters, there must be have corresponding small keyboard and Chinese phonetic characters window.

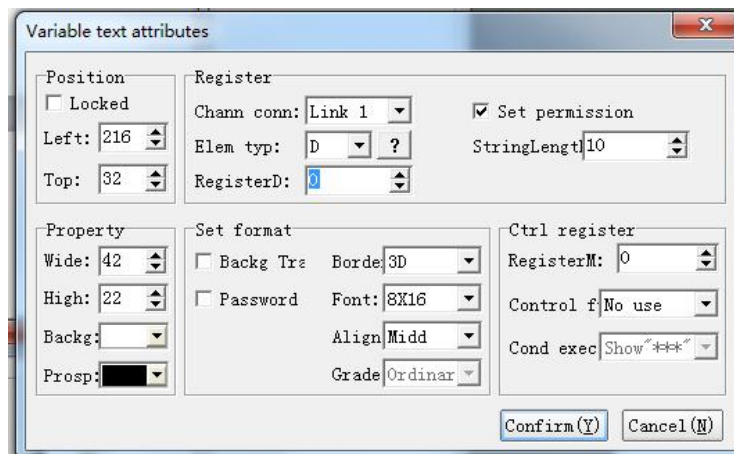

#### ➤ Position

Locked: lock elements, prevent well-adjusted pages from accidentally damage.

Left: Coordinates of the elements in the left page

Top: Coordinates of the elements in the top page.

**➤Property**

Width: width of elements

Height: height of elements

Background: background color

Foreground:foreground color

**➤Register**

Channel connection: select communication channel.

Element type: select element type

Register D: set register address

Set permission:controlled by keyboard.When selected, the data will be usually sent by keyboard to PLC, otherwise it will show text according to data from PLC, like action prompt and alarm prompt.

String length: Set the length of the string to display.

**➤Set Format**

Background transparent: filter color of background

Password : When selected, password protection will be effective

Border: border type

Font: font size

Align:alignment of text and element's border

Grade: password grade. Effective only when "password" is selected.

**➤Special/key register**

When the value of controlled register meets the designated conditions , this register will be executed.

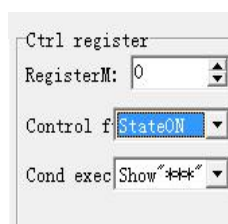

Above figure explanation: when register M0=ON, this variable text element will

show"\*\*\*\*"

## XV Letter Combinations

Letter Combination is to converse the designated letter (A-Z) to number, which is generally used for “programmable function setting”.

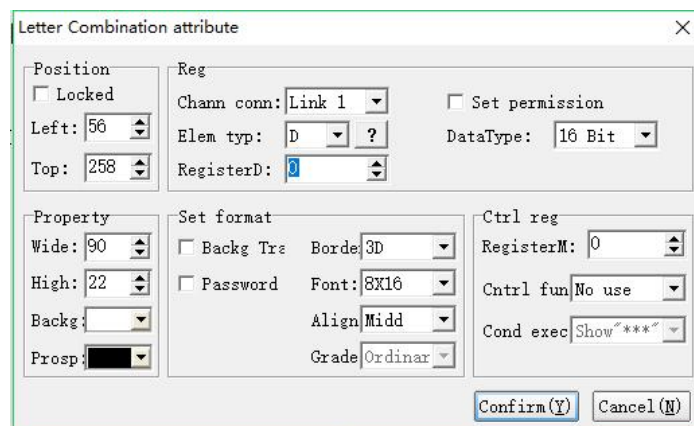

### ➤ Position

Locked: lock elements, prevent well-adjusted pages from accidentally damage.

Left: coordinates of the elements in the left page

Top: coordinates of the elements in the top page.

### ➤ Property

Width: width of elements

Height: height of elements

Background: background color

Foreground: foreground color

### ➤ Register

Channel connection: select communication channel.

Element type: select element type

Register D: set register's address

Set permission: controlled by keyboard. When selected, the data will be usually

sent by keyboard to PLC, otherwise it will show text according to data from PLC, like action prompt and alarm prompt.

String length: Set the length of the string to display.

### ➤Set format

Background transparent : filter color of background

Password : When selected, password protection will be effective

Border: border type

Font : font size

Align:alignment of text and element's border

Grade: password grade. Effective only when “password” is selected.

### ➤Special

The meaning of special attribute is the same with variable text .

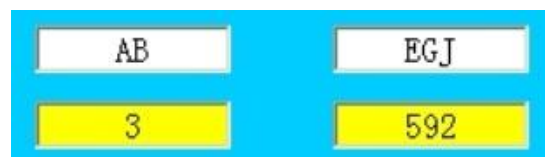

### Example:

The above figure means A corresponding to the zero bit of D620, B corresponding to the first bit of D620, C corresponding to the second bit of D620, D corresponding to the third bit of D620, E corresponding to the fourth bit of D620, F corresponding to the fifth bit of D620, G corresponding to the sixth bit of D620 and so on...

If set “AB”, which means the zero and first bit of D620 are both equal 1, the other bit is 0, that is D620=3. If set ”EGJ”, which means the fourth, sixth, ninth bit equal 1, the other bit is 0, that is D620=592.

### XVI Roll lamp

Text will circularly display as roll lamp. In addition, you can also set points of every movement and time intervals to decide display ways of rolling subtitle.

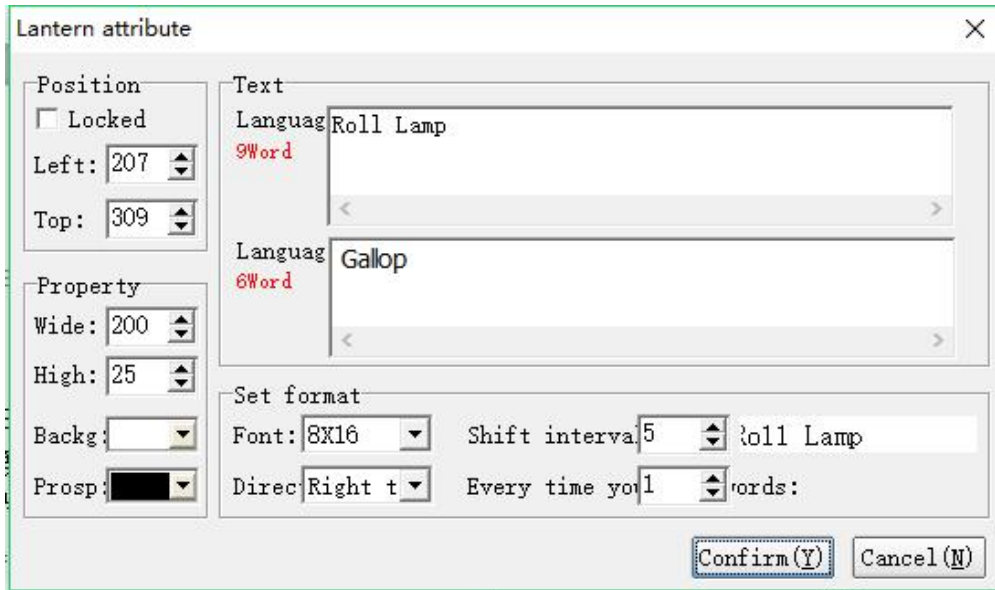

### ➤Position

Locked: lock elements, prevent well-adjusted pages from accidentally damage.

Left: coordinates of the elements in the left page

Top: coordinates of the elements in the top page.

### ➤Property

Width: width of elements

Height: height of elements

Background: background color

Foreground:foreground color

### ➤Text

Language 1 /2 /3 /4: Corresponding content will be displayed when system language is "X",

### ➤Set format

Font: set font size

Direction:The movement direction of roll lamp.

Delay: set movement internal delay

Word number: set word number for every movement

## XVII Polymorphic button component

The different states of the input or output are displayed by multi-state button elements.

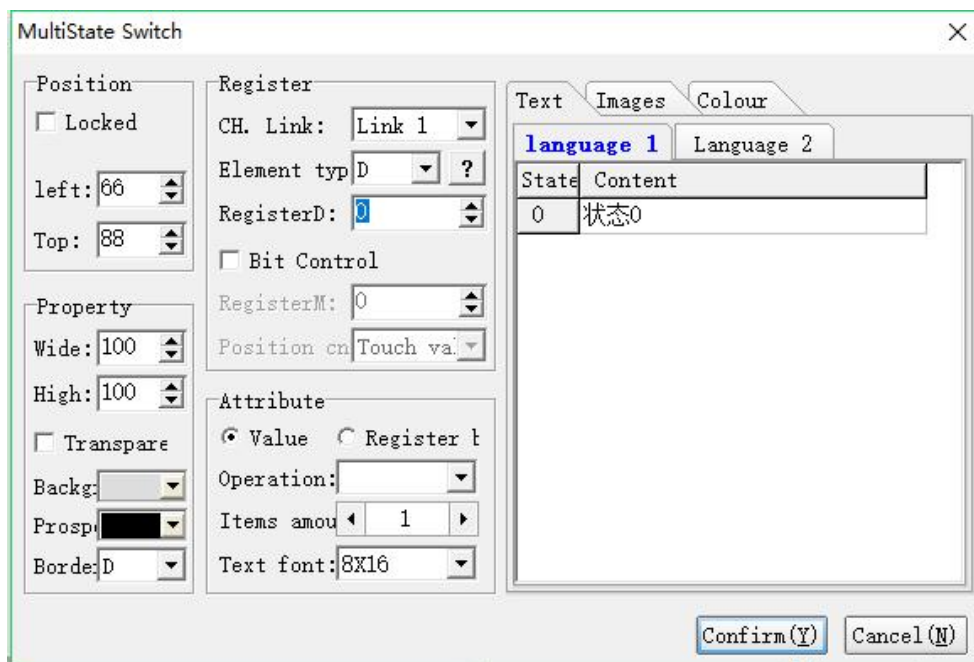

### ➤ Position property

Move Lock: Locks the component to prevent the layout from being accidentally damaged.

Left: The coordinates of the page at the far left of the component.

Top: The top of the component is at the coordinates of the page.

### ➤ Attribute property

Width: The width of the component.

Height: The height of the component.

Background transparency: Check this function, the component background is transparent, that is, the background color is filtered out.



Background: The background color of the component.

Prospect: The foreground of the component is the color of the text.

Border: Shows the type of border.

### ➤ Register property

Channel connection: Select the communication channel.

Component Type: Select the object type.

Register Number: Set the address of the register.

Accepted by bit: Check this function, the use or display mode of the element is controlled by the set register.

As shown in the figure: When M0 is ON, the multi-state button component is displayed. Otherwise hidden.

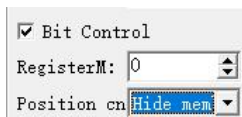

### ➤ Attributes

Numerical value: The change in polymorphism varies depending on the value of the register.

Register Bits: Polymorphic changes vary depending on the value of the bits in the register.

Operation mode: Select the recurrence mode of the status display, including rewinding, decrementing, reversing, decrementing, decrementing.

Total number of items: The total number of states.

Text font: Select the size of the text font.

### ➤ Text

Language: Set the corresponding text information when the status is displayed.

### ➤ Image

Picture: Set the corresponding picture information when the status is

displayed.

## XVIII Multi-state indicator component

The different states of the input or output are displayed by multi-state button elements.

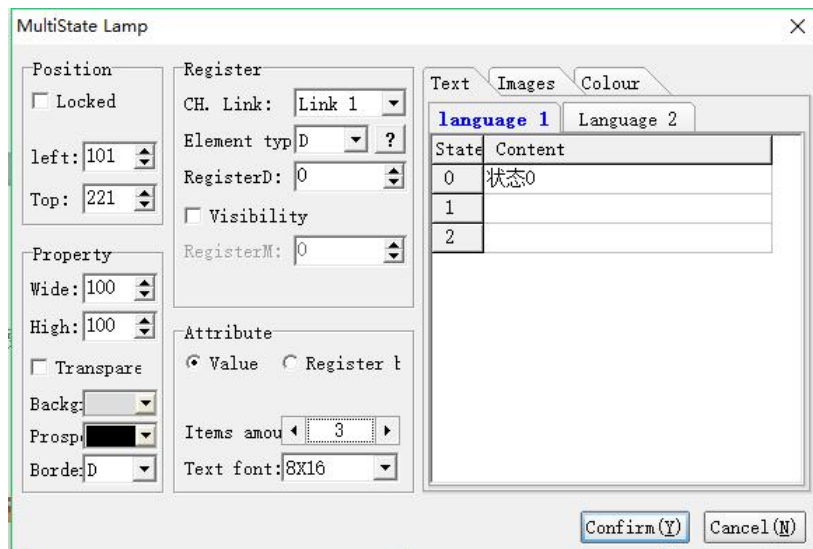

### ➤ Register property

Move Lock: Locks the component to prevent the layout from being accidentally damaged.

Left: The coordinates of the page at the far left of the component.

Top: The top of the component is at the coordinates of the page.

### ➤ Attribute property

Width: The width of the component.

Height: The height of the component.

Background transparency: Check this function, the component background is transparent, that is, the background color is filtered out.

Background: The background color of the component.

Prospect: The foreground of the component is the color of the text.

Border: Shows the type of border.

### ➤ Register property

Channel connection: Select the communication channel.

Component Type: Select the object type.

Register Number: Set the address of the register.

Visibility Control: Sets the register M that controls the display and hiding of this component.

As shown in the figure, when M10 is ON, the multi-state indicator light is



### ➤ Attributes

Numerical value: The change in polymorphism varies depending on the value of the register.

Register Bits: Polymorphic changes vary depending on the value of the bits in the register.

Total number of items: The total number of states.

Text font: Select the size of the text font.

### ➤ Text

Language: Set the corresponding text information when the status is displayed.

## ➤Image

Picture: Set the corresponding picture information when the status is displayed.

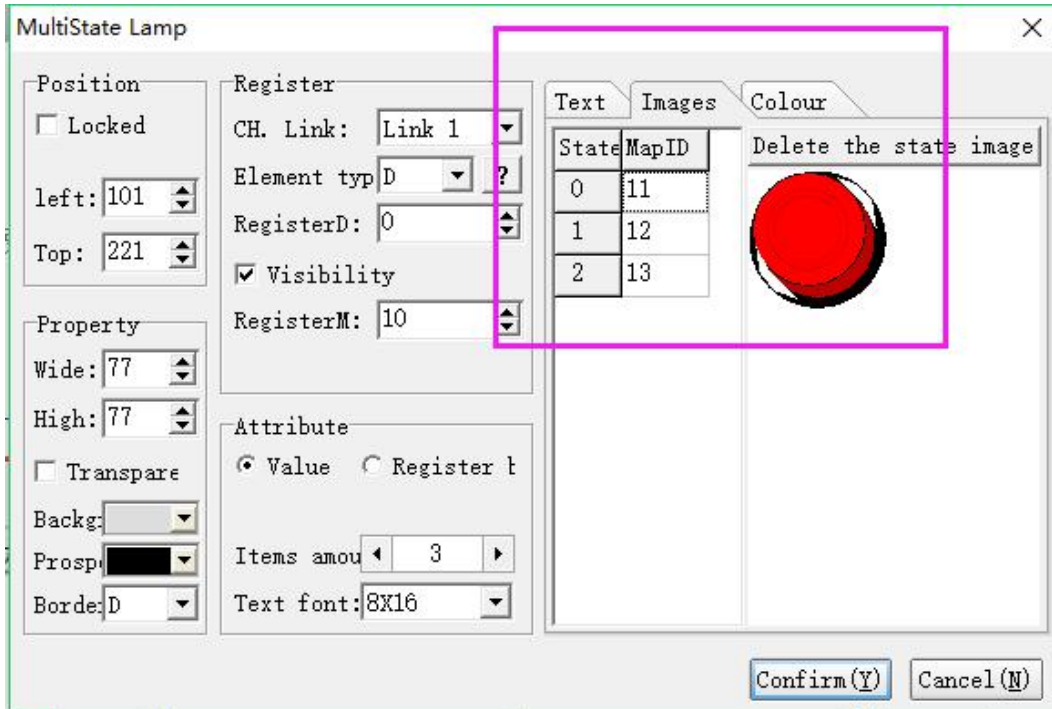

## XIX Date



Date element can be used for adjusting and displaying date.

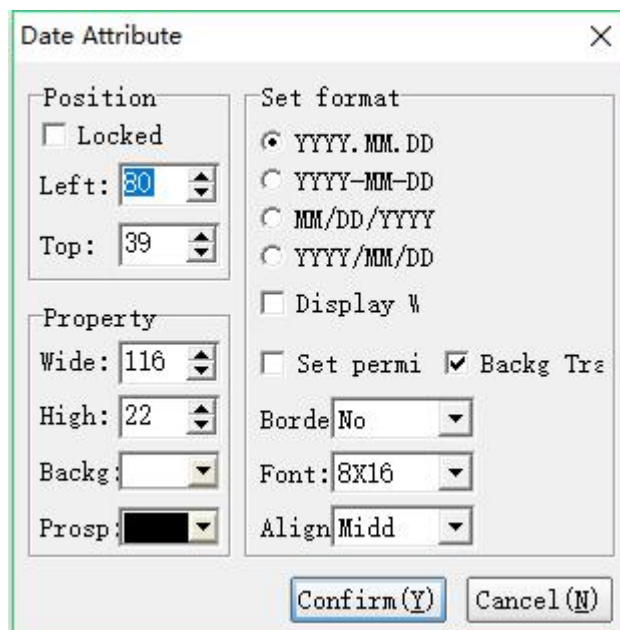

### ➤Position

Locked: lock elements, prevent well-adjusted pages from accidentally damage.

Left: coordinates of the elements in the left page

Top: coordinates of the elements in the top page.

### ➤Property

Width: width of elements

Height: height of elements

Background: background color

Prospect:foreground color

### ➤Set format

Display format: Take May 22<sup>th</sup>,2007 as an example, when select YYYY-MM-DD: 2007-05-22; when select MM/DD/YYYY:22/5/2007

Week: week will be displayed before date

Set permission: it can be set only when selected, otherwise it can just be displayed but can not be adjusted.

Background transparent :filter background color

Border: select border type

Font: set font size

Align:Alignment of displayed content and text border.

### ➤Various attribute example



**XX Time**

Time element is used for adjusting and displaying time.

**➤Position**

Locked: lock elements, prevent well-adjusted pages from accidentally damage.

Left: coordinates of the elements in the left page

Top: coordinates of the elements in the top page.

**➤Property**

Width: width of elements

Height: height of elements

Background: background color

Prospect:foreground color

**➤Set Format**

Set permission: it can be set only when selected, otherwise it can be just displayed but can not be adjusted.

Background Transparent:filter background color

Border:select border type

Font: set font size

Align: Alignment of displayed content and text frame

### ➤ Various attribute example

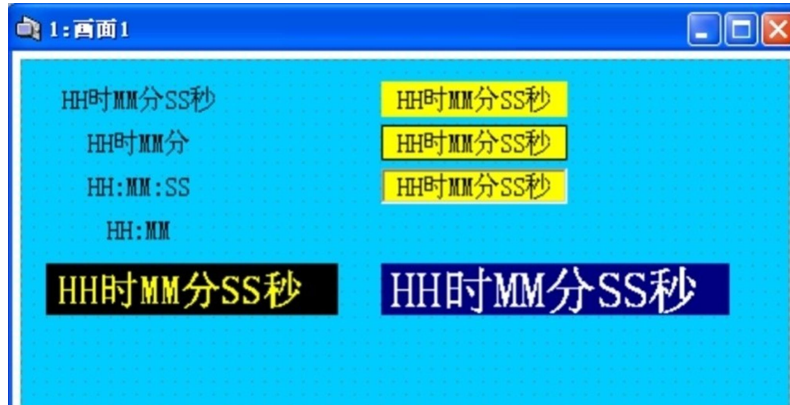

## XXI SQL query component

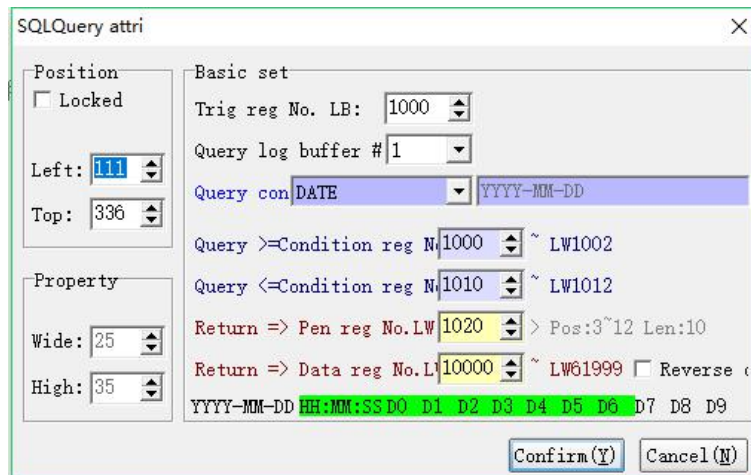

### ➤ Position property

Move Lock: Locks the component to prevent the layout from being accidentally damaged.

Left: The coordinates of the page at the far left of the component.

Top: The top of the component is at the coordinates of the page.



### ➤ Attribute

Width: The width of the component.

Height: The height of the component.

### ➤ Basic setting properties

Trigger Register Number LB: Set the register number that triggers the query condition.

Query record buffer #: Set the buffer where the query data is located.

Query conditions: Set the query conditions.

Query >= <= condition register number LW: Set the range of the query register.

Return to the number of the register number: Set the number of the returned data to store the register.

Return Data Register Number: Sets the register in which the returned data is stored.

Reverse output: The data returned when checked is sorted in reverse order.

## XXII SSsliding block component

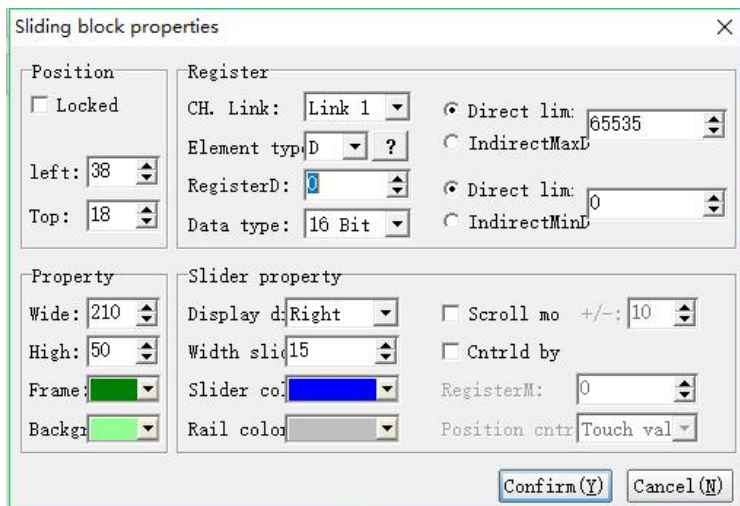

Sliding block properties

Position

Locked

left: 38

Top: 18

Register

CH. Link: Link 1

Element type: D ?

RegisterD: 0

Data type: 16 Bit

Direct lim: 65535

IndirectMaxB

Direct lim: 0

IndirectMinB

Property

Wide: 210

High: 50

Frame:

Backgr:

Slider property

Display d: Right

Width slid: 15

Slider co:

Rail color:

Scroll mo +/-: 10

Cntrld by

RegisterM: 0

Position cntr: Touch val

Confirm(Y) Cancel(N)

### ➤ Position property

Move Lock: Locks the component to prevent the layout from being accidentally damaged.

Left: The coordinates of the page at the far left of the component.

Top: The top of the component is at the coordinates of the page.

### ➤ **Attribute**

Width: The width of the component.

Height: The height of the component.

Frame: The color of the frame of the component.

Background: The background color of the component.

### ➤ **Basic attribute**

Channel connection: Select the communication channel.

Component Type: Select the object type.

Register Number: Set the address of the register.

Data type: 16 bits / 32 bits can be selected.

Direct upper and lower limits: set the maximum and minimum data of the slider, limited by the constant

Indirect upper and lower limits: Set the maximum and minimum data of the slider, which is limited by the values of other registers.

### ➤ **Slider property**

Display direction: Set the direction in which the slider slides, and the left, right, up, and down options.

Slider width: Set the width of the slider, which can be set according to specific needs.

Slider color: Set the color of the slider.

Slide color: Set the color of the slide.

Scroll mode: Sets the length of the slider slide each time the slider is manually clicked.

Position control: Set the registers and control methods that are controlled.

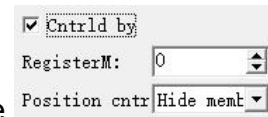

As shown in the figure, when M0 is ON, the slider is visible.

### ➤ Various attribute example:

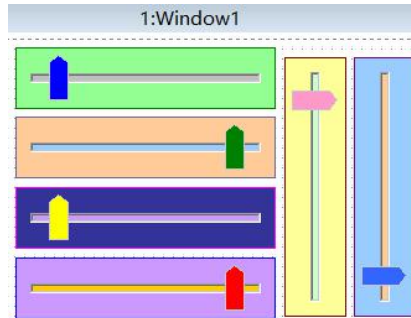

## XXIII Drop-down box component

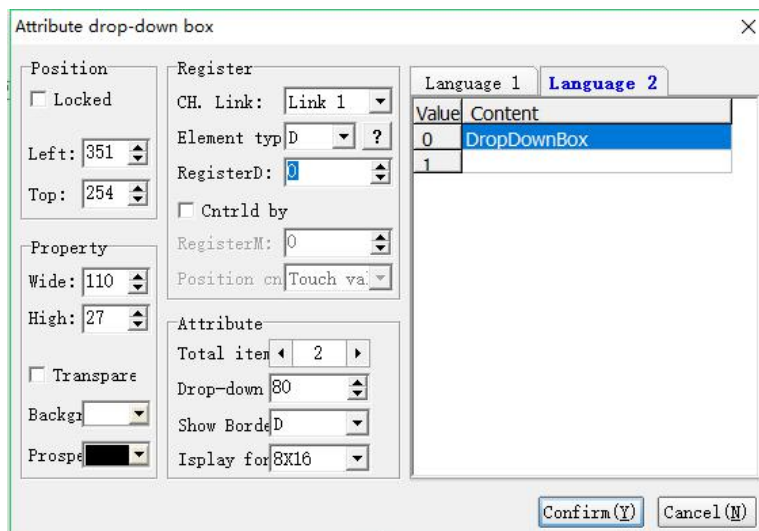

### ➤ Position property

**Move Lock:** Locks the component to prevent the layout from being accidentally damaged.

**Left:** The coordinates of the page at the far left of the component.

**Top:** The top of the component is at the coordinates of the page.

### ➤ Special Attribute

**Width:** The width of the component.

**Height:** The height of the component.

Background transparency: Check this function, the component background is transparent, that is, the background color is filtered out.

Background: The background color of the component.

Prospect: The foreground of the component is the color of the text.

### ➤ Basic attribute

Channel connection: Select the communication channel.

Component Type: Select the object type.

Register Number: Set the address of the register.

Position control: Set the registers and control methods that are controlled.

As shown in the figure, when M8 is ON, the drop-down box can be

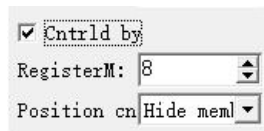

selected.

### ➤ Attributes

Total Items: Set the number of drop-down options.

Pull-down height: Set the height of the drop-down box.

Show Border: Sets the type of component border.

Display font: Set the size of the component font.

### ➤ Language attribute

Languages 1 / 2: Set the contents of the drop-down options for each language.

## XXIV Dynamic alarm bar component

### ➤ Position property

Move Lock: Locks the component to prevent the layout from being accidentally damaged.

Left: The coordinates of the page at the far left of the component.

Top: The top of the component is at the coordinates of the page.

### ➤ Attribute

Width: The width of the component.

Height: The height of the component.

Background: The background color of the component.

Prospect: The foreground of the component is the color of the text.

### ➤ Display attribute

Border: Sets the component border type.

Font: Set the component font size.

Move: Set the direction in which the alarm information is moved.

Movement speed: Set the movement speed in words.

Additional information: Set additional information for alarm information, optional None, alarm time, alarm number.

Alarm sequencing: Set the order in which alarm messages appear.

### ➤ Control attribute

Visibility Control: Check this function to see if the component is visible and controlled by the set register.

Channel connection: Select the communication channel.

Component Type: Select the object type.

Register Number: Set the address of the register.

As shown, when the 0th bit of D0 is 1, the component is

visible.

No alarm information is automatically hidden: Check this function, the component will be visible when there is alarm information.

### ➤ Set alarm information

1. Enter the OP working parameter setting page, as shown below,

2. Check the alarm/voice option.
3. Set the alarm trigger condition, optional D or M.

4. Set the alarm content as shown:

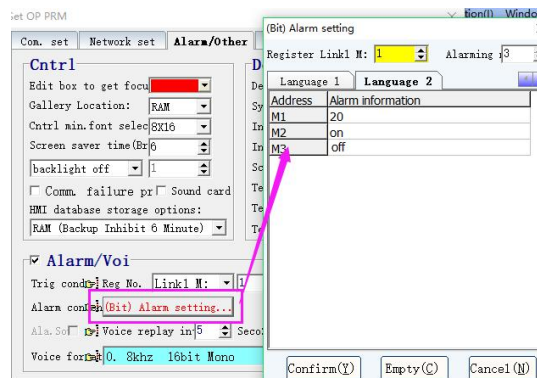

5. Click the [OK] button.



## XXV Historical data list

The list is used for saving historical production conditions, usually used for production management and SPC tracking record and etc.

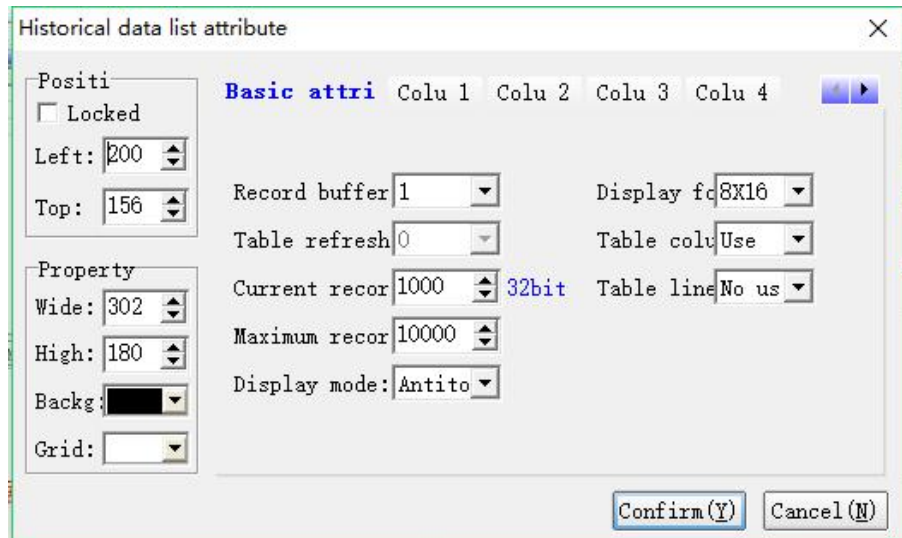

### ➤ Position

Locked: lock elements, prevent well-adjusted pages from accidentally damage.

Left: Coordinates of the elements in the left page

Top: Coordinates of the elements in the top page.



**➤Property**

Width: The width of the component.

Height: The height of the component.

Background: Background color.

Prospect: foreground color.

Lattice: plaid color

**➤Basic attribute**

Record buffer: Select the location of the recording area.

Table Refresh Flag: Select the trigger flag address.

Current number of records: Set the register address where the current number of records is saved.

Maximum number of records: Set the maximum number of lines for recording.

Password protection: When you set the usage, you can delete the record only by entering the password.

Display font: Shows the size of the font.

Table column line: The table shows column lines, which can be used or not.

Table row line: The table shows line lines, which can be used or not.

### ➤ Record buffer setting

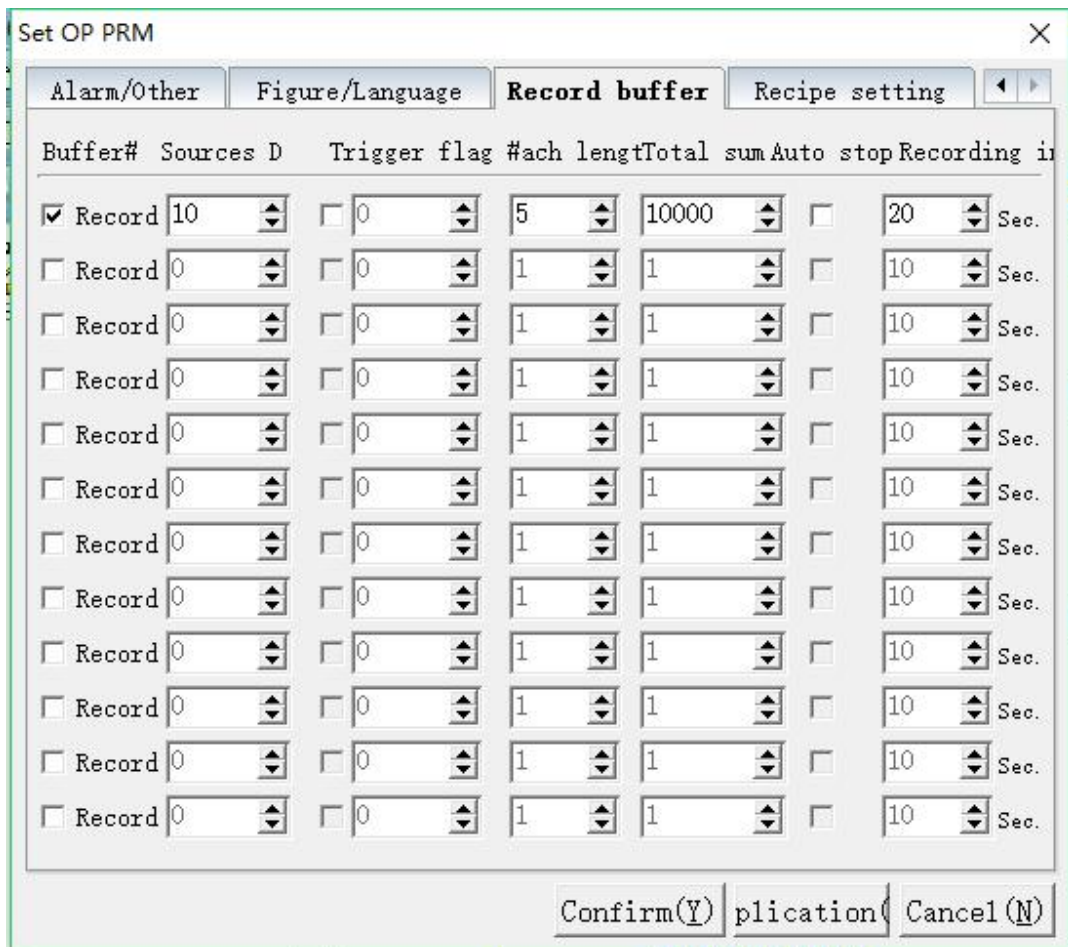

Buffer#	Sources D	Trigger flag	#ach	lengt	Total sum	Auto stop	Recording in
<input checked="" type="checkbox"/> Record	10	<input type="checkbox"/> 0	5	10000	10000	<input type="checkbox"/>	20 Sec.
<input type="checkbox"/> Record	0	<input type="checkbox"/> 0	1	1	1	<input type="checkbox"/>	10 Sec.
<input type="checkbox"/> Record	0	<input type="checkbox"/> 0	1	1	1	<input type="checkbox"/>	10 Sec.
<input type="checkbox"/> Record	0	<input type="checkbox"/> 0	1	1	1	<input type="checkbox"/>	10 Sec.
<input type="checkbox"/> Record	0	<input type="checkbox"/> 0	1	1	1	<input type="checkbox"/>	10 Sec.
<input type="checkbox"/> Record	0	<input type="checkbox"/> 0	1	1	1	<input type="checkbox"/>	10 Sec.
<input type="checkbox"/> Record	0	<input type="checkbox"/> 0	1	1	1	<input type="checkbox"/>	10 Sec.
<input type="checkbox"/> Record	0	<input type="checkbox"/> 0	1	1	1	<input type="checkbox"/>	10 Sec.
<input type="checkbox"/> Record	0	<input type="checkbox"/> 0	1	1	1	<input type="checkbox"/>	10 Sec.
<input type="checkbox"/> Record	0	<input type="checkbox"/> 0	1	1	1	<input type="checkbox"/>	10 Sec.
<input type="checkbox"/> Record	0	<input type="checkbox"/> 0	1	1	1	<input type="checkbox"/>	10 Sec.
<input type="checkbox"/> Record	0	<input type="checkbox"/> 0	1	1	1	<input type="checkbox"/>	10 Sec.

Confirm(Y) Application Cancel(N)

Buffer#: the location of record buffer

Data source D: Set initial address of register, as shown in figure:the initial is D8

Trigger flag#: Set conditions for trigger, the address is a 32 bit register which is used as initial address of fast reading area.

example: triggered flag is 0, and starting address of fast reading area is D8. So the address of triggering flag is D8.0

Each Length: represents the quantity of registers being stored from data resource D (including the initial address of data resource D)

example: store D10-D14 these five register

Total sum: represent the total quantity of storage

Auto-stop:When selected, the system will stop automatically after recording the whole quantity, otherwise it will be covered automatically.

Record intervals: save data according to time intervals and the unit is second.

**Note: recording condition can only be trigger flag or record intervals.**

## Historical data list Column 1

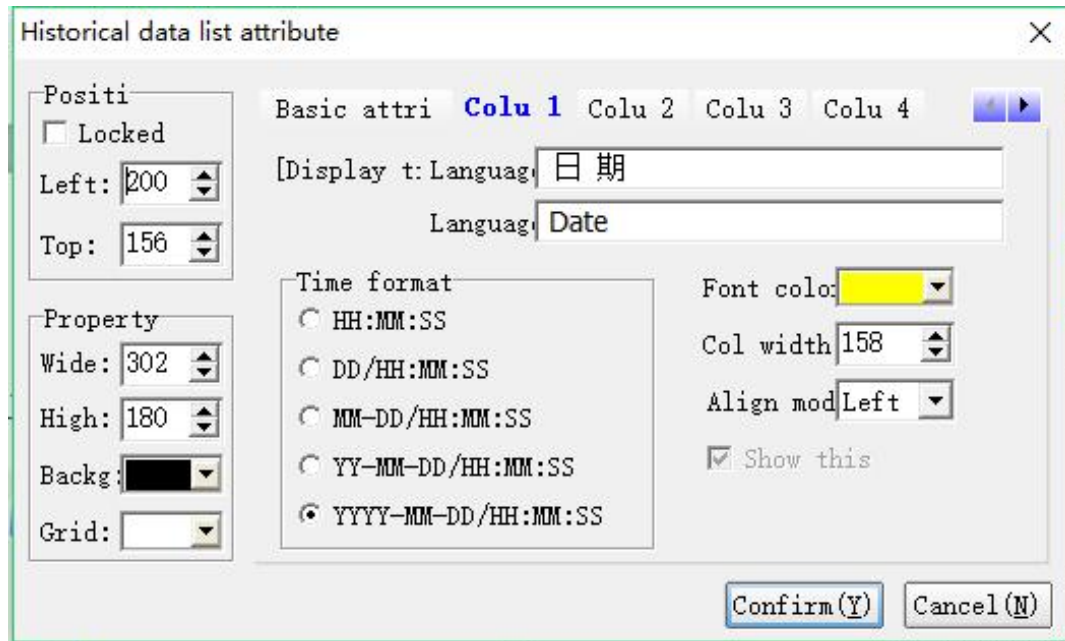

### ➤ Column 1

Language 1 / 2 / 3 / 4: corresponding content displayed by the title of this list when the system language is “X”

Time format: set format of date and time

Font color: font color displayed in this list

Column width : Set column width of this list

Align : alignment of displayed content and width of this list

Show this list: select whether display this list

## Historical data list Column 2 .....15



### ► Column 2.....15

Language 1/ 2 /3 /4: When the system language selects the language "x", the corresponding content displayed in the column header.

Data location: Select the saved data location, where 16-bit data occupies a data location, 32-bit and floating-point numbers data occupies two data locations.

Data Type: Three types of 16-bit, 32-bit, and floating-point numbers can be selected.

Data Format: Select the data format displayed in this column, and select the signed number and unsigned number.

Integer Digits: Sets the number of integer digits displayed in this column.

Decimal Places: Set the number of decimal places displayed in this column.

Font color: This column displays the color of the font.

Column Width: Set the width of the column.

Alignment: Aligns the display with the width of this column.

Zero leader: Zero display in front of the data, such as "0001".

Show this column: Select whether to display this column.

### ► Various examples.

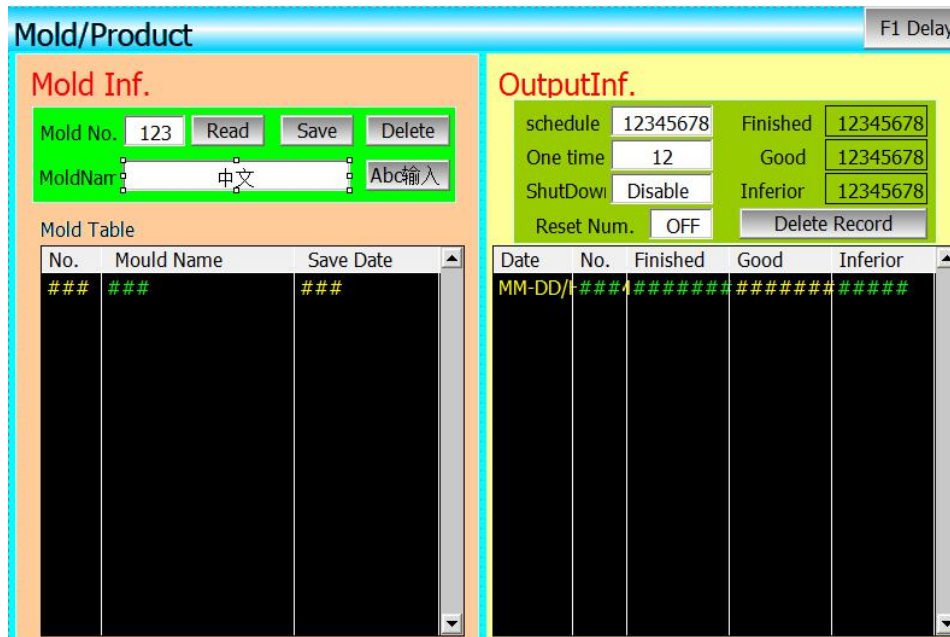

\* Used for Th production management legend

Mold/Product
F1 Delay

### Mold Inf.

Mold No.

MoldName:

#### Mold Table

No.	Mould Name	Save Date
###	###	###

### OutputInf.

schedule  Finished

One time  Good

ShutDown  Inferior

Reset Num.

Date	No.	Finished	Good	Inferior
MM-DD/	###	#####	#####	#####

\*For SPC tracking record legend

### SPC Record

Interval  Period  Number

Date	No.	Cycle	HldTrans	HldPlace	FedPlace	MldOpnPla
	0	0.00	0.00	0.00	0.00	0.0
	0	0.00	0.00	0.00	0.00	0.0
	0	0.00	0.00	0.00	0.00	0.0
	0	0.00	0.00	0.00	0.00	0.0
	4660	24.66	7.77	8.88	46.60	5803.6
	6976	84.41	7.77	8.88	69.76	5803.6
	597	29.32	7.77	8.88	5.97	5803.6
	3722	42.56	7.77	8.88	37.22	5803.6
	8256	27.90	7.77	8.88	82.56	5803.6
	7179	30.66	7.77	8.88	71.79	5803.6

## XXVI Recipe

(Only MT60 series touch screen supports downloading data)

The transmission of recipe data can trigger a continuous register data transmission. This transmission can not only be downloaded from recipe memory to PLC, but also can be uploaded from PLC to recipe memory, which



provide convenience for operation.

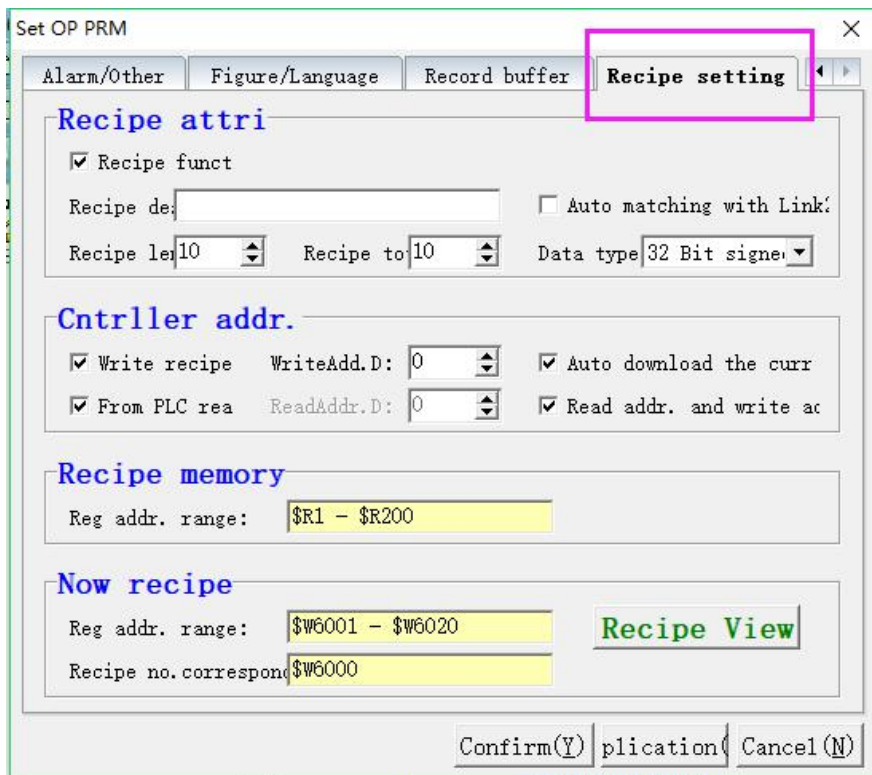

Automatic matching using link2 scanner: The data setting of the current recipe is read by the link2 scanner.

Recipe description: description and description of the name of the current recipe file;

Recipe length: the length and number of the current recipe read record address, the address of the recipe record table is

Sequence sorted, the system automatically generates unchangeable; maximum length 1000;

Total formula: the number of formulas, up to 5000 formulas;

(Remark: Recipe length \* Address range occupied by data category \* Total number of recipes <=60000)

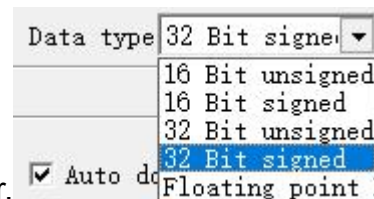
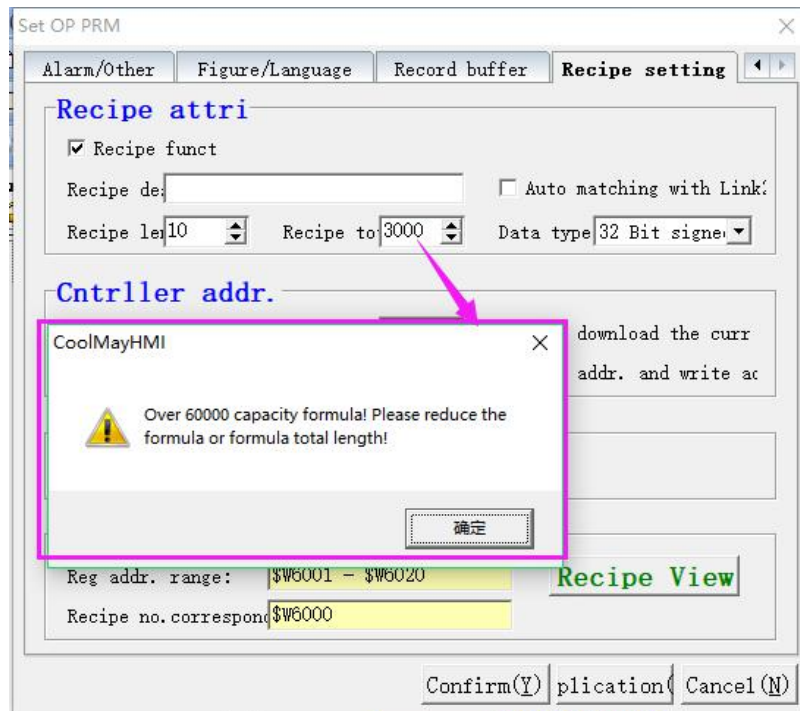

Data category: the data type of the data register,

(Note: 16-bit data occupies one address, 32-bit data and floating-point numbers occupy two address ranges;)

Write recipe to PLC: set the relevant data register address of the recipe and PLC;

Read recipe from PLC: set the data register address of the recipe and PLC;

Recipe memory: The storage address range of the recipe in the HMI, which can be automatically generated and cannot be changed; the maximum memory is \$W0-\$W60000.

Current recipe: The storage address of the recipe in the HMI and the data registers in the PLC are automatically generated in a sorted manner and cannot be changed.

## Recipe data view and function key

1. Set up recipe configuration as methods mentioned above, as shown below:

(Recipe viewing method, [debug] - [view recipe])

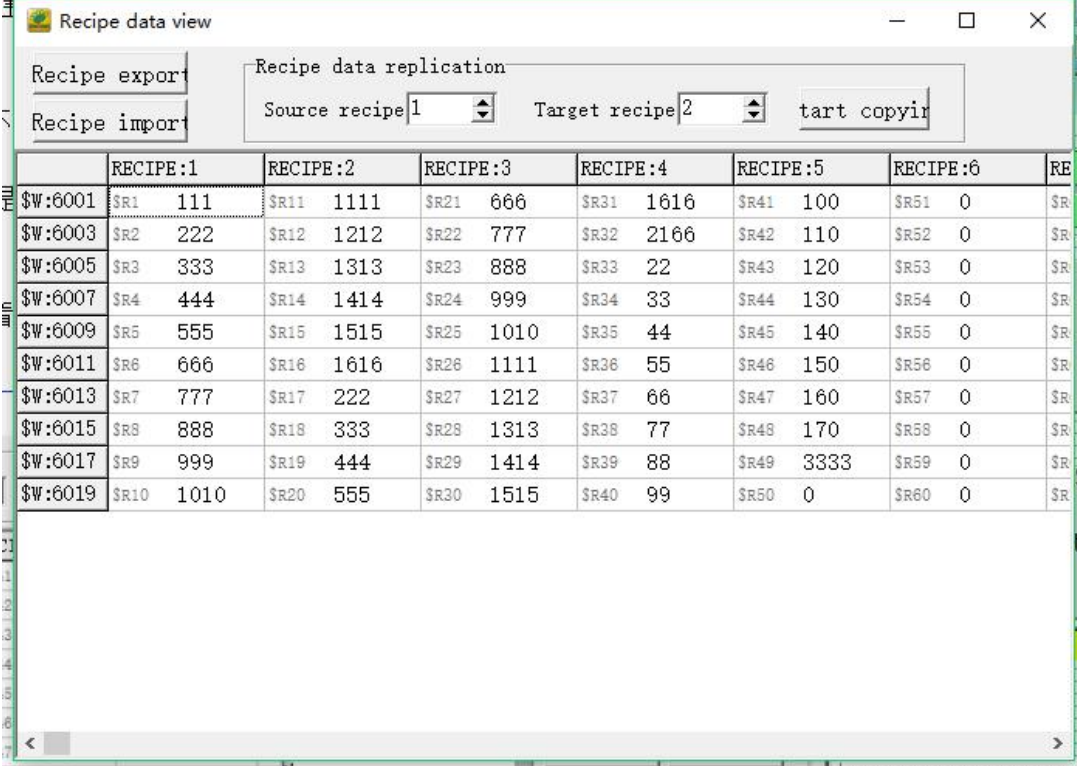

The screenshot shows a window titled "Recipe data view" with a "Recipe data replication" section containing "Source recipe" set to 1 and "Target recipe" set to 2, with a "Start copying" button. Below this is a table with columns for recipe numbers and their members.

	RECIPE:1	RECIPE:2	RECIPE:3	RECIPE:4	RECIPE:5	RECIPE:6	RE
\$W:6001	\$R1 111	\$R11 1111	\$R21 666	\$R31 1616	\$R41 100	\$R51 0	\$R
\$W:6003	\$R2 222	\$R12 1212	\$R22 777	\$R32 2166	\$R42 110	\$R52 0	\$R
\$W:6005	\$R3 333	\$R13 1313	\$R23 888	\$R33 22	\$R43 120	\$R53 0	\$R
\$W:6007	\$R4 444	\$R14 1414	\$R24 999	\$R34 33	\$R44 130	\$R54 0	\$R
\$W:6009	\$R5 555	\$R15 1515	\$R25 1010	\$R35 44	\$R45 140	\$R55 0	\$R
\$W:6011	\$R6 666	\$R16 1616	\$R26 1111	\$R36 55	\$R46 150	\$R56 0	\$R
\$W:6013	\$R7 777	\$R17 222	\$R27 1212	\$R37 66	\$R47 160	\$R57 0	\$R
\$W:6015	\$R8 888	\$R18 333	\$R28 1313	\$R38 77	\$R48 170	\$R58 0	\$R
\$W:6017	\$R9 999	\$R19 444	\$R29 1414	\$R39 88	\$R49 3333	\$R59 0	\$R
\$W:6019	\$R10 1010	\$R20 555	\$R30 1515	\$R40 99	\$R50 0	\$R60 0	\$R

This recipe has 4 subsidiary recipes, each recipe has 10 members, its saved address is HMI's memory address from LW6001 to LW6010.

2. When recipe configuration is set up, the next step is to display the recipe on screen and can be changed or directly download in PLC. Therefore the below control function are needed.

**Display recipe:** add data register  in the newly created screen, set

Elem type: LW

RegisterLW:

the attribute as: , After confirming, click the right mouse button in the input box position, and copy 10 registers in one column in the

vertical position;

**Click function key:** successively add recipe function key to advanced function menu

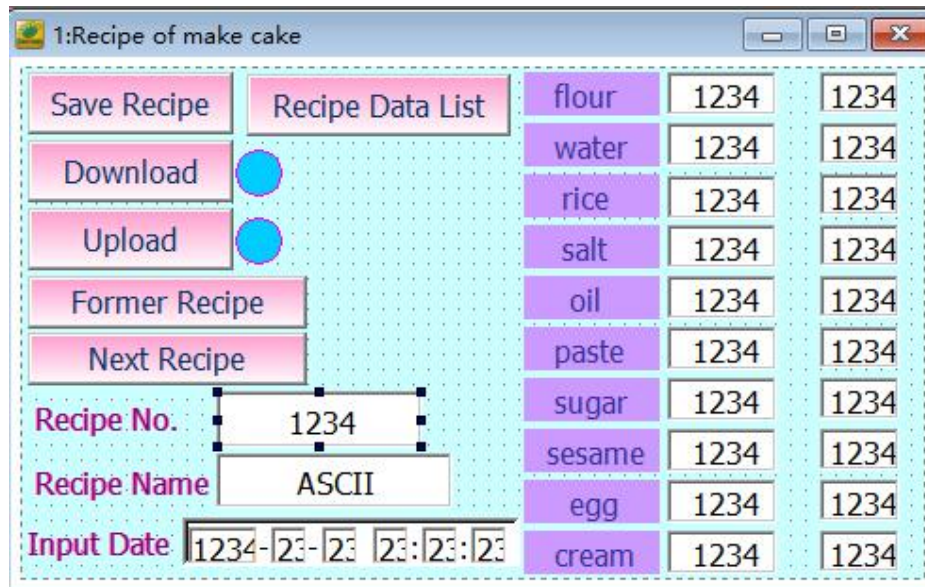

Through the relevant function settings in the function keys, buttons can be created on the screen to write each group recipe to the PLC and read the recipe from the PLC, save the recipe, and select the previous recipe and the latter recipe.

### Special instructions of recipe

Pay attention to below points when using formula function:

1. Notice the data type selection when writing the required recipe parameters in the recipe table. 16-bit data occupies one word, 32-bit data occupies two words, and the data type selection must be consistent when selecting the control, especially pay attention to 32-bit. Use of data addresses. Since 32-bit data occupies two words, it is necessary to prevent data address overlap when inputting addresses in the write address and the monitor address.
2. The address LW6000 is fixed and can only be used to change the recipe number. It cannot be used anywhere else. And the value of LW6000 is 0, it means the first recipe number, and so on; LW8001.0 is the recipe download

indicator, LW8001.1 is the recipe upload indicator; LW8002 is fixed as the recipe input name.

3. The recipe parameter address is continuous.



## XXVII Alarm record list

(Only MT60 series touch screen supports downloading data)

Alarm record list is used for displaying real-time content and historical alarm record.

This list can control event message and display triggering time by a register's address message, meanwhile it can save historical record in inner data base of MT series PLC. The target address and numbers of recording can be set freely by user.

### ➤Position

Locked: lock elements, prevent well-adjusted pages from accidentally damage.

Left: Coordinates of the elements in the left page

Top: Coordinates of the elements in the top page.

**➤Property**

Width: width of elements

Height: height of elements

Background: background color

Grid: grid color

**➤Basic attributes**

Max. No. of recording: set maximum row No. of recording

Password: record can be deleted only when the password is entered.

Font : set font size

Current recording No.: Assign the whole quantity of current alarm recording to the designated register

All record number of cleared message ID : function key is an advanced function, set the ID of sending message as 30000, and all the record content clear processing will be executed after detecting the message.

The value of the selected row: the number of rows in the row, for example, LW3001=1, indicating that the first row of the alarm log table is selected. (Note: This feature has not been activated yet)

Controller control: optional prohibition or permission. Select the corresponding control register function (b0: next page; b1: upper page; b2: downlink; b3: uplink)

Channel selection: channel for manipulating registers, optional link1 or link2.

Component Type: Select the component type of the manipulation register.



### ➤ Alarm record list column 1



Alarm record list attribute

Basic attri **Colu 1** Colu 2 Colu 3

[Display t: Language] 报警时间  
Language Alarm Time  
Time form YY-MM-DD HH:MM:SS

Property

Wide: 302  
High: 180  
Backg:    
Grid:

Font color:    
Col width: 100  
Align mod: Left

Confirm(Y) Cancel(N)

### Column 1 attribute

Language 1/2/3/4: corresponding content display by the title when system language is “X”.

Time format: set format of time and date

Font color: set font color of this list

Column Width: set column width

Align: alignment of the content and the width of this list

### ➤ Alarm record list column 2



Alarm record list attribute

Basic attri Colu 1 **Colu 2** Colu 3

[Display t: Language] 编号  
Language NO.

Property

Wide: 302  
High: 180  
Backg:    
Grid:

Font color:    
Col width: 50  
Align mod: Left

Confirm(Y) Cancel(N)



**Column 2 attribute**

Languages 1/ 2/ 3/ 4: When the system language selects the language "x", the corresponding content displayed in the column header.

Font color: This column displays the color of the font.

Column Width: Set the width of the column.

Alignment: Aligns the display with the width of this column.

➤ **Alarm record list** column 3 

Alarm record list attribute

Position

Locked

Left: 74

Top: 142

Property

Wide: 302

High: 180

Backg:

Grid:

Basic attri Colu 1 Colu 2 **Colu 3**

[Display t: Language] 报警内容

Language Alarm matter

Font color:

Col width 130

Align mod Left

Confirm(Y) Cancel(N)

**Column 3 attribute**

Languages 1/ 2/ 3/ 4: When the system language selects the language "x", the corresponding content displayed in the column header.

Font color: This column displays the color of the font.

Column Width: Set the width of the column.

Alignment: Aligns the display with the width of this column.

## Example

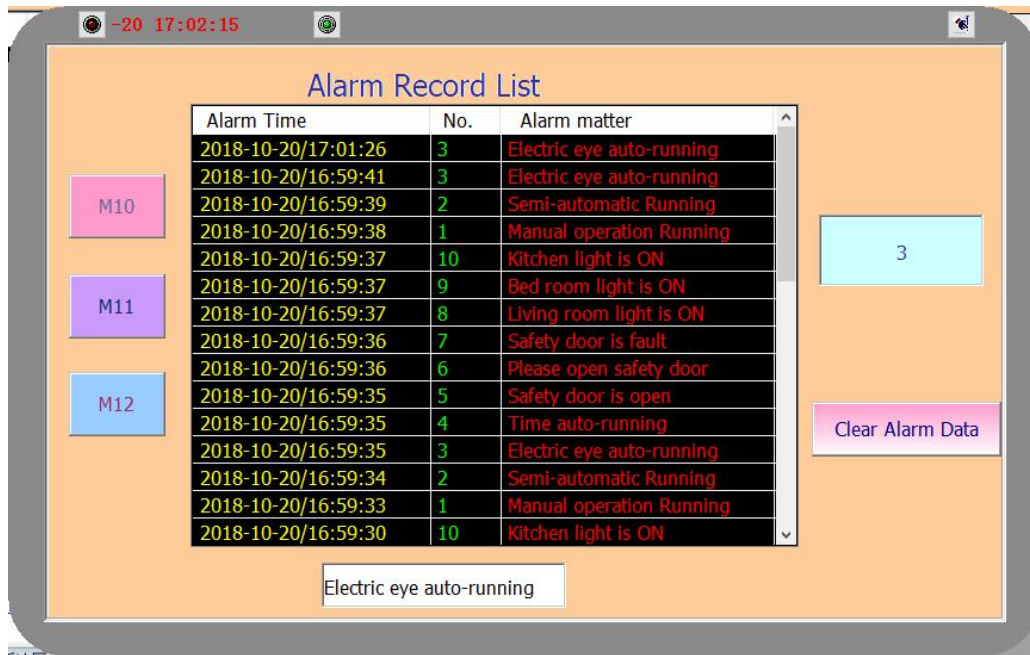

## Set alarm record register

In [OP parameter]>>[Alarm/others], the triggering condition can be set as D register or M register.

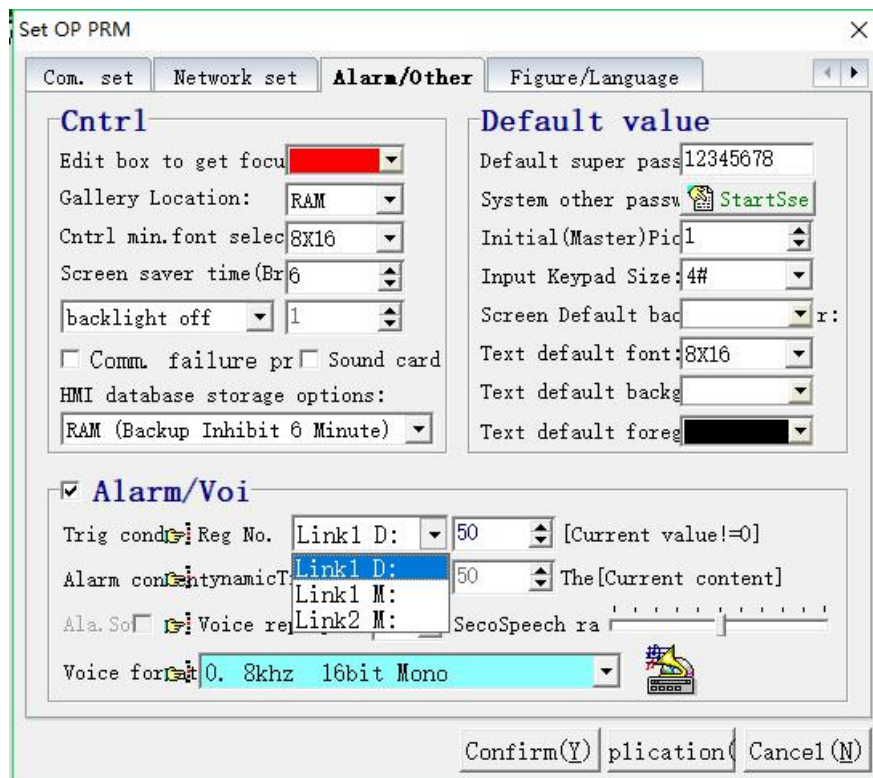

### Set triggering condition as M

Trig cond: Reg No. **Link1 M:** 50

Alarm con: **(Bit) Alarm setting...**

When triggering condition is M,

Click [alarm setting] and set alarm register and content.

(Bit) Alarm setting

Register M: 0 Alarming: 2

Address	Alarm information
M0	
M1	

Confirm (Y) Empty (C) Cancel (N)

Link1 or Link2 channels can be set.

### Set triggering condition as D

Alarm/Voi

Trig cond: Reg No. **Link1 D:** 50

When triggering condition is D dynamic text

 need to be added to set alarm content. If the alarm is triggered, the value of register will also be triggered in PLC and contents corresponded will be displayed in the list .

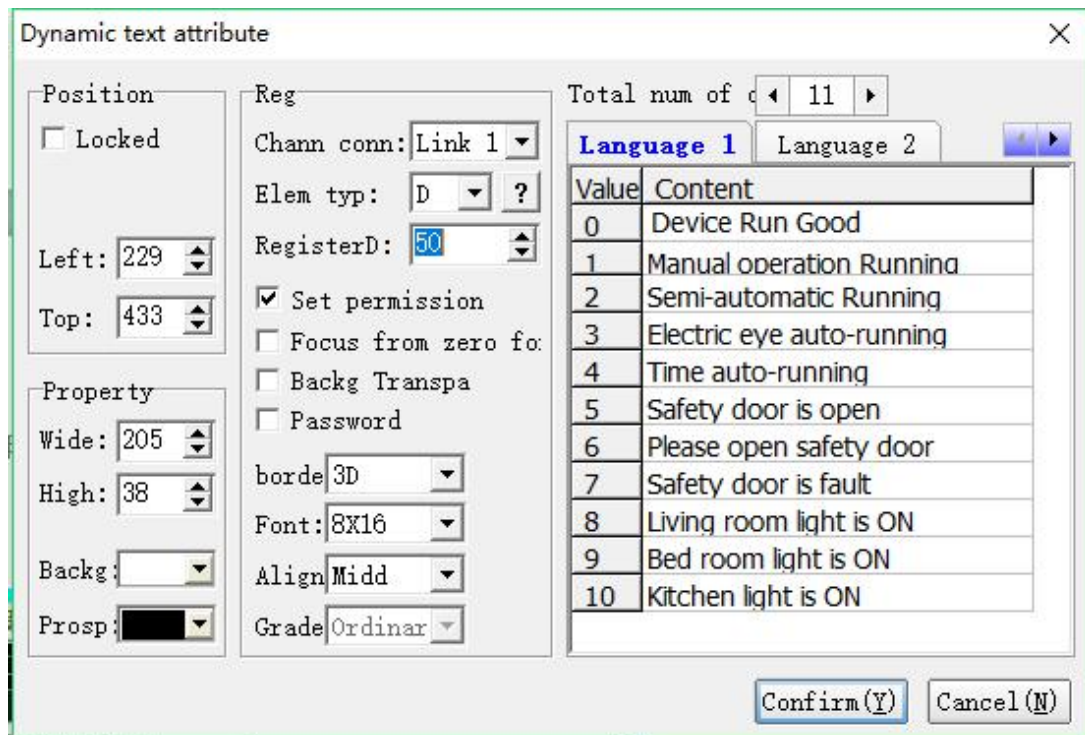

## XXVIII Real-time alarm list

The real-time alarm table displays real-time alarm information, and the information will no longer be displayed after the alarm is released. The function is the same as the dynamic alarm bar.

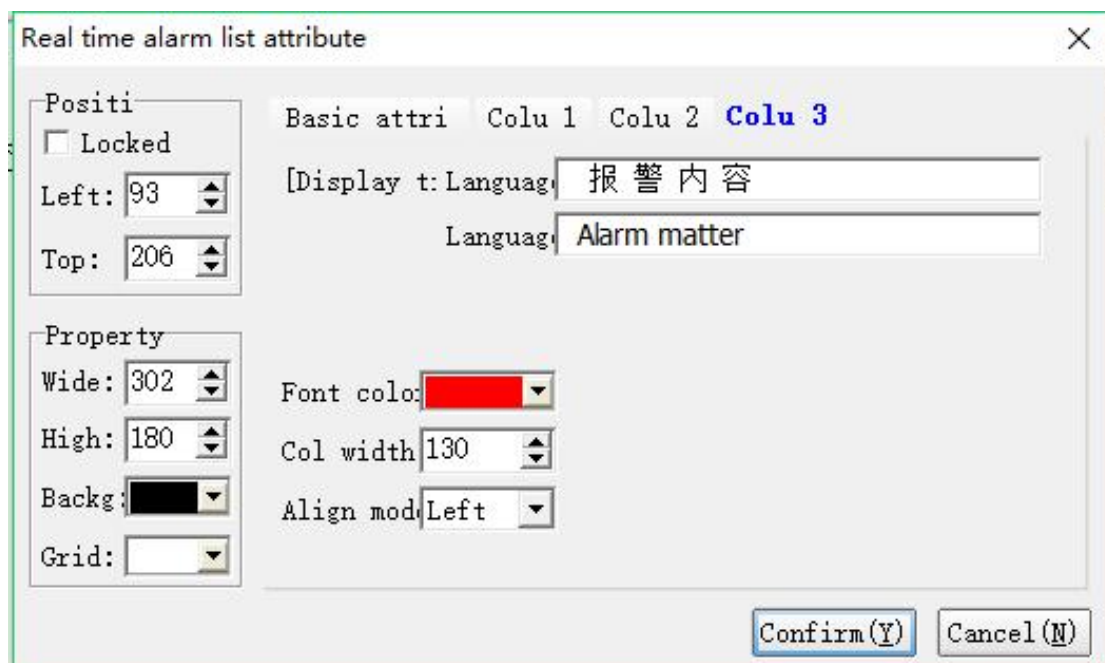

**➤Position**

Locked: lock elements, prevent well-adjusted pages from accidentally damage.

Left: coordinates of the elements in the left page

Top: coordinates of the elements in the top page.

**➤Property**

Width: width of elements

Height: height of elements

Background: background color

Grid: grid color

**➤Display attributes**

Maximum display: Sets the maximum number of alarm information records.

Password protection: Enter the password of the corresponding level when using.

Display font: Set the component font size.

Current record number LW: Set the register that displays the current number of recorded alarms (this register is the HMI built-in register).

The value of the selected row LW: Sets the register that displays the current alarm record as the first few rows.

Controller Manipulation: Set whether to allow register control.

Channel connection: Select the communication channel when the controller is allowed to operate.

Component Type: Select the object type when the controller is allowed to manipulate.

Register Number: Sets the register used when the controller is allowed to manipulate.

Max. display:	99	Bar	Selec. Row LW:	3001
Password:	No		PLC cntrl:	Allow
Display font:	8X16		Chann conn:	Link 1
Curre. Rec. LW:	3000		Elem typ:	D ?
Cntrl [b0:NextPage; b1:UpPage; b2:Down; b3:Up]				
RegisterD:	10			

As shown in the figure: when D10=1, the alarm list page down; when D10=2, the alarm list is paged up;

when D10=4, the alarm table points to the next line;

when D10=8, the alarm table points to the previous line;

## XXIX Memo



Memo is used for recording, displaying text and taking notes.

Memo attribute

<b>Position</b> <input type="checkbox"/> Locked Left: 37 Top: 22	<b>Basic</b> <input type="checkbox"/> Edit licen <input type="checkbox"/> Password Borde: 3D Font: 8X16 Grade: Ordinary Reel: Vertical Row s: 0 >3 Word	<b>Text</b>   Ctrl   Advanced 备忘录 < >
<b>Property</b> Wide: 302 High: 180 Backg: Prosp:		Confirm(Y)   Cancel(N)



**➤Position**

Locked: lock elements, prevent well-adjusted pages from accidentally damage.

Left: Coordinates of the elements in the left page

Top: Coordinates of the elements in the top page.

**➤Property**

Width: width of elements

Height: height of elements

Background: background color

Prospect: foreground color

**➤Basic attributes**

Permission: When selected, contents can be modified by keyboard.

Password protection: effective only when “permission” is selected and only with certain grade can password protection be modified.

Border: type of frame

Font: font size

Grade: password grade, password can be effective only when “password protection” is selected.

Scroll:select whether the scroll is effective vertically or horizontally

Row space: the distance between two rows



**Memo Text**

Set the initial content of the body.

The screenshot shows a software window with three tabs: 'Text', 'Ctrl', and 'Advanced'. The 'Text' tab is selected. Inside the window, there is a large text area containing the word 'text' followed by a cursor. The window has a standard scroll bar on the right side.

**Memo Control**

The screenshot shows a software window with three tabs: 'Text', 'Ctrl', and 'Advanced'. The 'Ctrl' tab is selected. The interface contains several configuration options:

- 'This memo ID:' followed by a numeric spinner set to 299.
- 'Control chann' followed by a dropdown menu set to 'Link 1'.
- 'Control eleme' followed by a dropdown menu set to 'D' and a question mark icon.
- An unchecked checkbox labeled 'Visibil cor'.
- Below the checkbox, 'RegisterD:' followed by a numeric spinner set to 0, an equals sign, a 'K' label, and another numeric spinner set to 0.
- Another unchecked checkbox labeled 'Automatic text up'.
- Below the second checkbox, 'RegisterD:' followed by a numeric spinner set to 0 and the text 'Data changes'.

## ➤ Control

Memo ID: set ID of this memo, all IDs of memo in one project are exclusive.

Control channel: choose communication channel

Control element type: choose element type

Control visibility: when selected, memo can be displayed on screen only when the data of ID equals the designated value.

Text Auto-update : when selected and the stated ID changes, the text will be updated automatically.



## Memo advanced

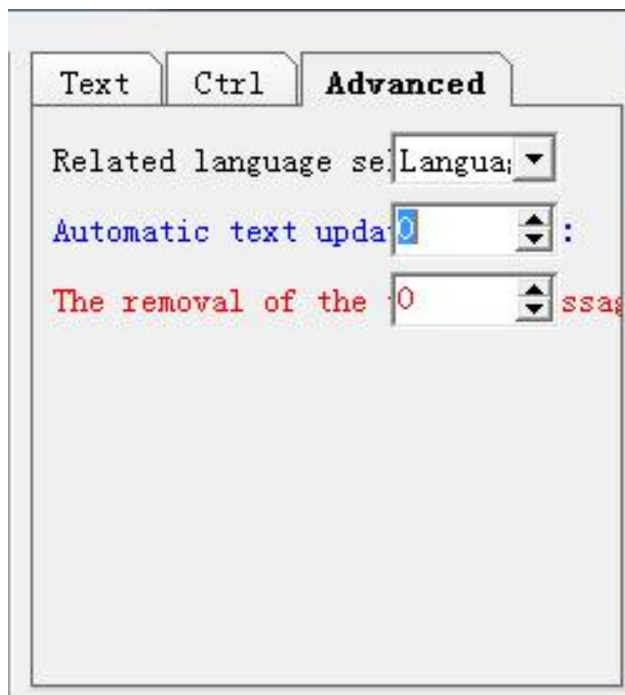

## ➤ Advanced attribute

Related language: select system language corresponding to the dealt mode of this memo

ID used for triggering message of downloading text: When receive the set ID, the text will be downloaded to U flash disk.

ID used for triggering message of clearing text: When receive the set ID, the text will be deleted.

➤ **Example.**

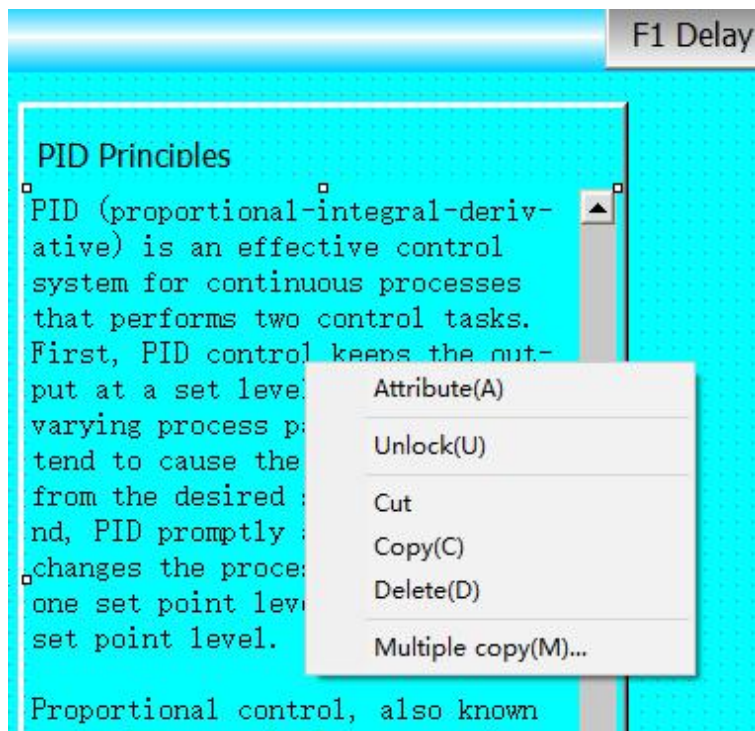

**XXX Audio playback component** 

(Only supported by MT60 series touch screen)

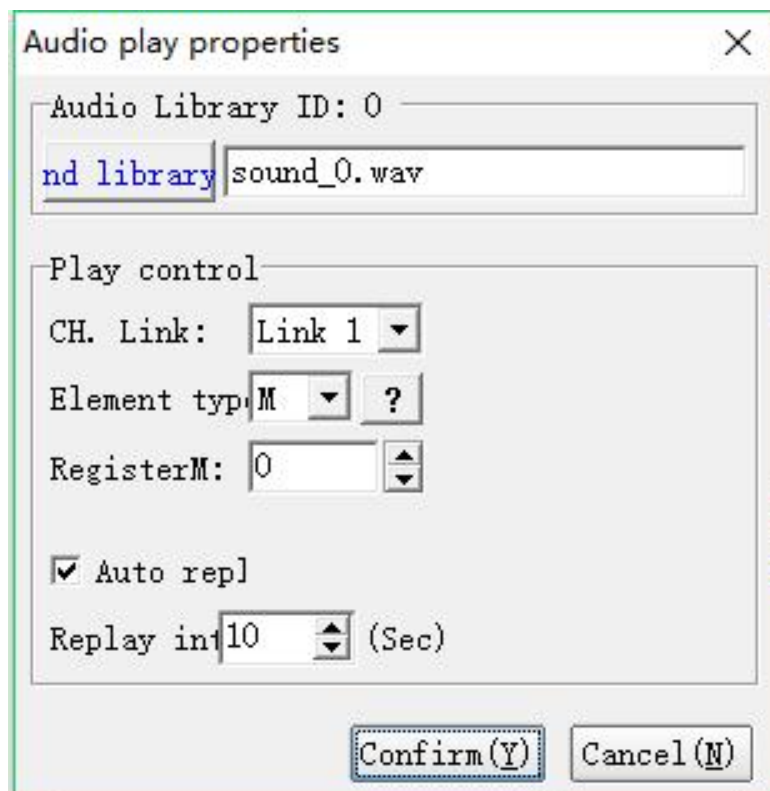

### ➤ Sound library

Click this button to add, replace, delete, export, play, cancel, etc. the desired audio.

### ➤ Playback control

Channel connection: Select the communication channel that controls playback.

Component Type: Select the type of object that controls playback.

Register Number: Select the register that controls playback.

Auto Replay: Sets the playback interval for replay.

**Note:** This audio playback function is optional. You must check the “Set working parameters--alarm other--with sound card” option when using.

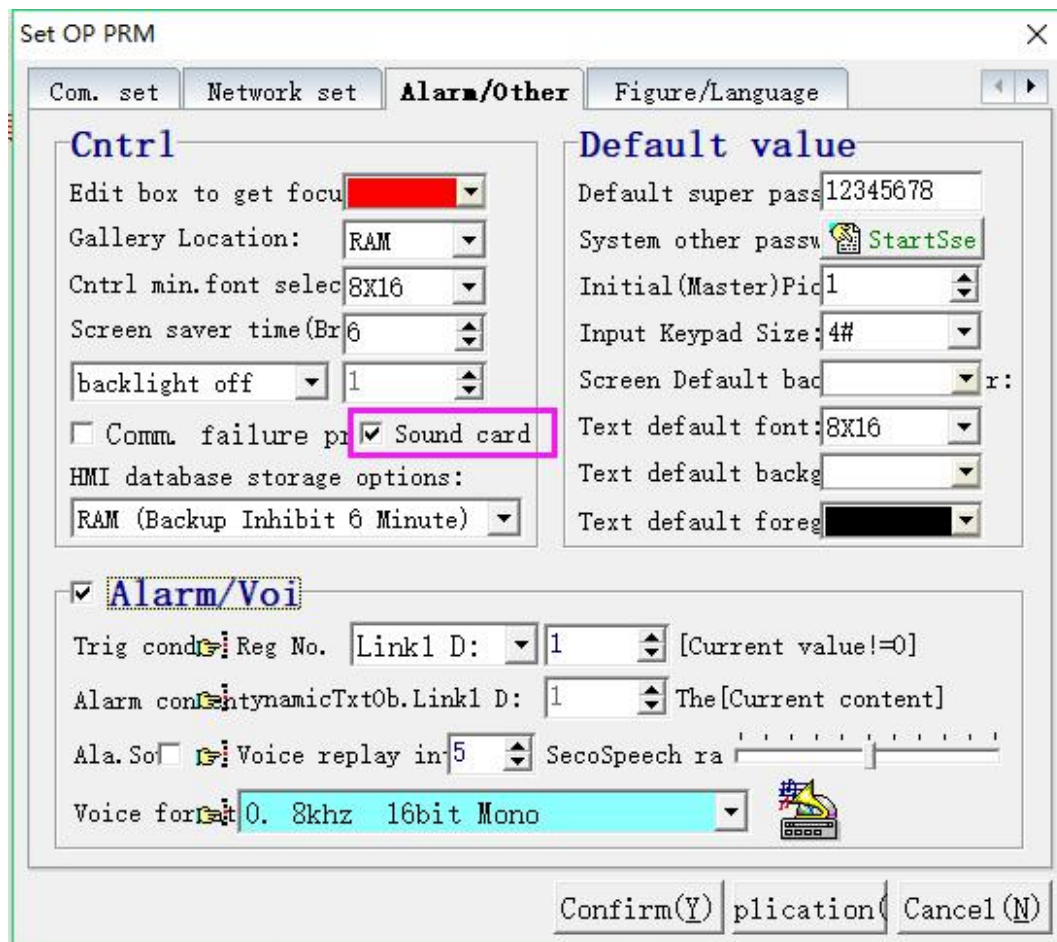

**XXXI Rectangle**

Rectangle element is used for database publishing and partition, screen displaying and modification and ect...

**➤Position**

Locked: lock elements, prevent well-adjusted pages from accidentally damage.

Left: coordinates of the elements in the left page

Top: coordinates of the elements in the top page.

**➤Property**

Width: width of elements

Height: height of elements

**➤Register**

Channel connection: select communication channel.

Element type: select element type

X moving: when selected, elements will horizontally move along X axis. When the register value increase or decrease 1, the element will move one pixel towards the left or the right.

Y moving: when selected, elements will vertically move along Y axis. When the register value increase or decrease 1, the element will move one pixel towards the left or the right.

Visibility: when auxiliary contact M is driven ON, the element will display. When driven OFF, the element will be hidden.

### ➤Set format

Fill : when selected, fill the color which has been set, otherwise the graph will only display the frame and other Sections will be transparent.

Line color: the frame color.

Fill color: the color which is filled, it is effective only when the function FILL is selected.

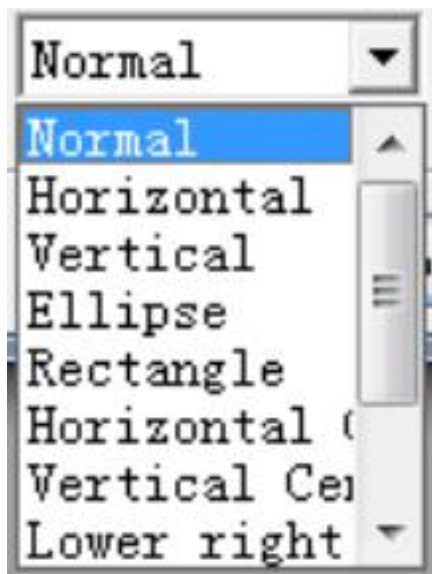

Effect: there are 11 special effects

➤ Example: fill effect is “normal”

1) application

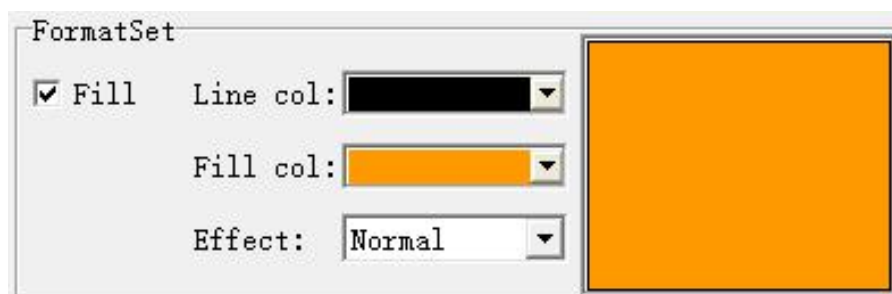

2) property

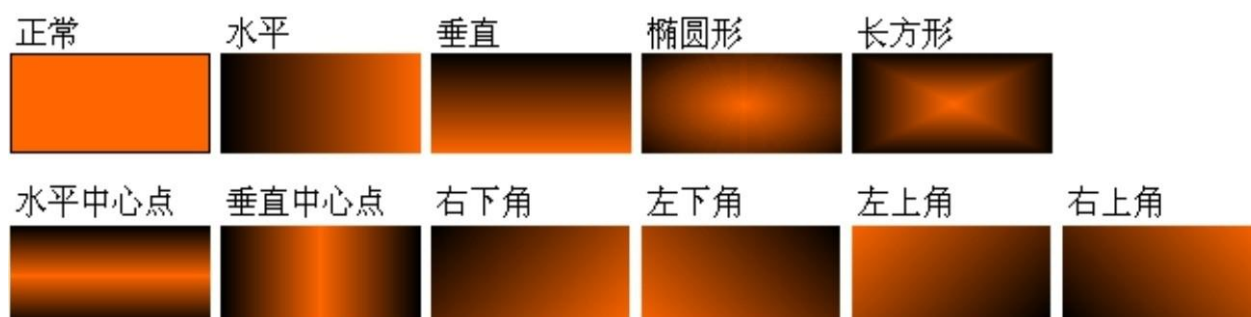





### XXXII Hollow rectangle

Hollow rectangle can also be used for database publishing and partition, image displaying and modification and ect...

#### ➤Position

Locked: lock elements, prevent well-adjusted pages from accidentally damage.

Left: coordinates of the elements in the left page.

Top: coordinates of the elements in the top page.

#### ➤Property

Width: width of elements

Height: height of elements

#### ➤Register

Channel connection: select communication channel.

Element type: select element type

X moving: when selected, elements will horizontally move along X axis. When the register value increase or decrease 1, the element will move one pixel towards the left or the right.

Y moving: when selected, elements will vertically move along Y axis. When the register value increase or decrease 1, the element will move one pixel towards the left or the right.

Visibility: when auxiliary contact M is driven ON, the element will display. When driven OFF, the element will be hidden.

### ➤ Set Format

Fill : when selected, fill the color which has been set, otherwise the graph will only display the frame and other Sections will be transparent.

Line color: the frame color.

Fill color: the color which is filled, it is effective only when the function FILL is selected.

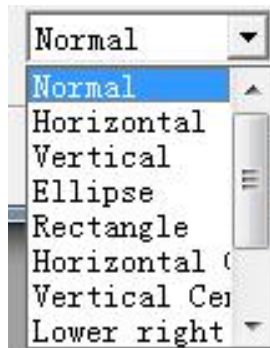

Effect: there are 11 special effects

**Example:** fill effect is “Vertical”

1) application

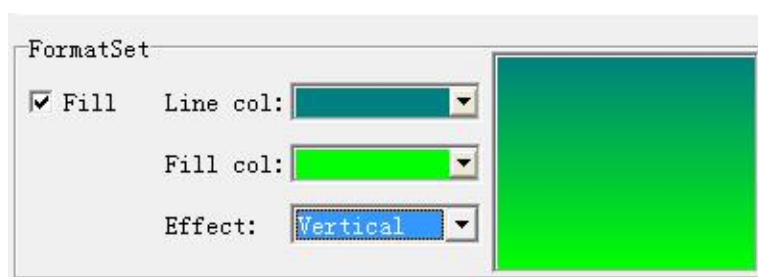

## 2) property

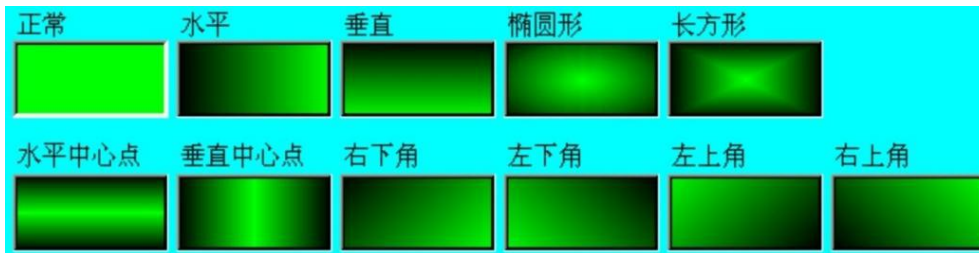
**XXXIII Convex Rectangle**

Convex rectangle can be used for data layout , modification of screen display,etc.

**➤Position**

Locked: lock elements, prevent well-adjusted pages from accidentally damage.

Left: coordinates of the elements in the left page

Top: coordinates of the elements in the top page.

**➤Property**

Width: width of elements

Height: height of elements

### ➤Register

Channel connection: select communication channel.

Element type: select element type

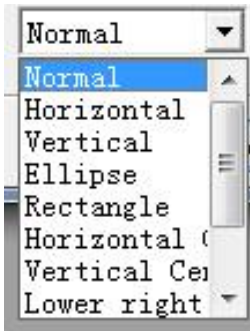

X moving: when selected, elements will horizontally move along X axis. When the register value increase or decrease 1, the element will move one pixel towards the left or the right.

Y moving: when selected, elements will vertically move along Y axis. When the register value increase or decrease 1, the element will move one pixel towards the left or the right.

Visibility: when auxiliary contact M is driven ON, the element will display. When driven OFF, the element will be hidden.

### ➤Set Format

Fill : when selected, fill the color which has been set, otherwise the graph will only display the frame and other Sections will be transparent.

Line color: the frame color.

Fill color: the color which is filled, it is effective only when the function FILL is selected.

Effect: there are 11 special effects

**Example** : effect=oval

1) Application



2) Property

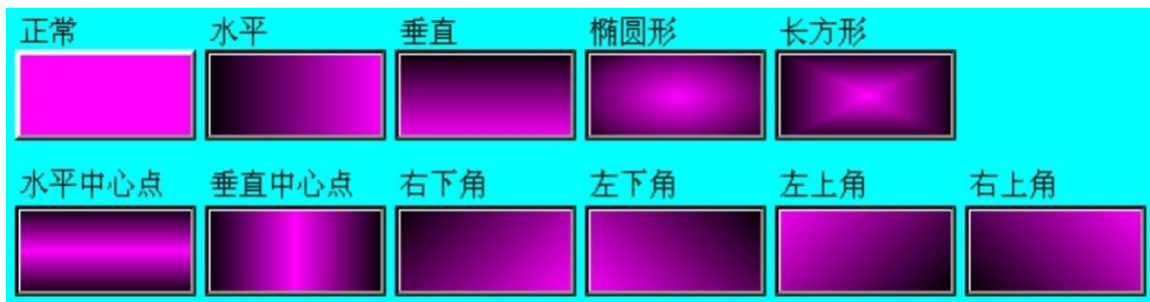

### XXXIV Cross pipes

Cross pipes is used for flow definition, it can simulate the technological process on the spot and can also modification of screen display, etc.

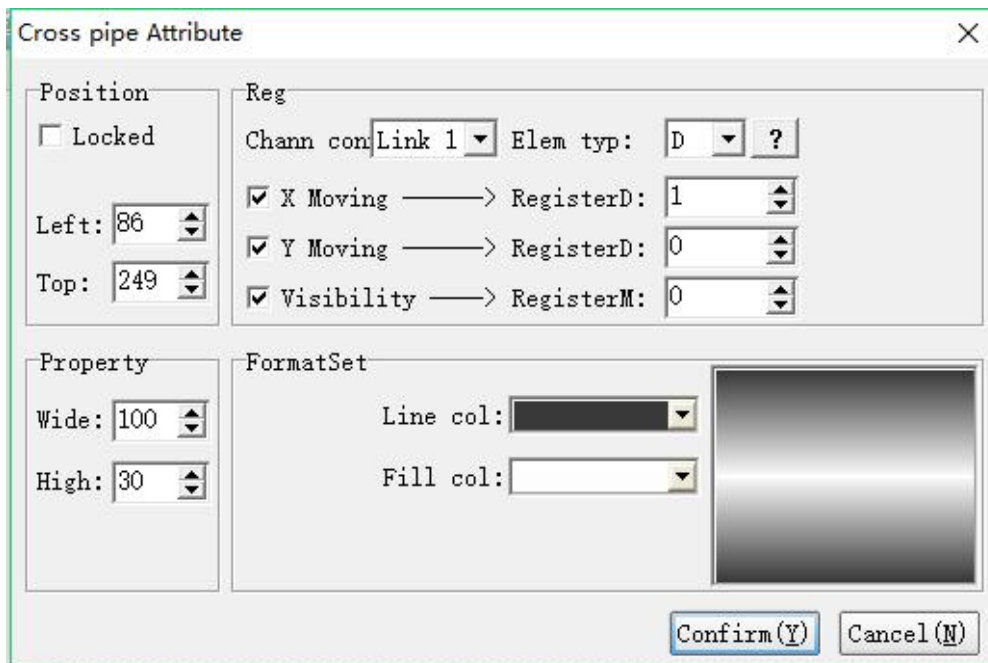

**➤Position**

Locked: lock elements, prevent well-adjusted pages from accidentally damage.

Left: coordinates of the elements in the left page

Top: coordinates of the elements in the top page.

**➤Property**

Width: width of elements

Height: height of elements

**➤Register**

Channel connection: select communication channel.

Element type: select element type

X moving: when selected, elements will horizontally move along X axis. When the register value increase or decrease 1, the element will move one pixel towards the left or the right.

Y moving: when selected, elements will vertically move along Y axis. When the register value increase or decrease 1, the element will move one pixel towards the left or the right.

Visibility: When the set register M=ON, the component is displayed. When OFF, the component is hidden.

**➤Set Format**

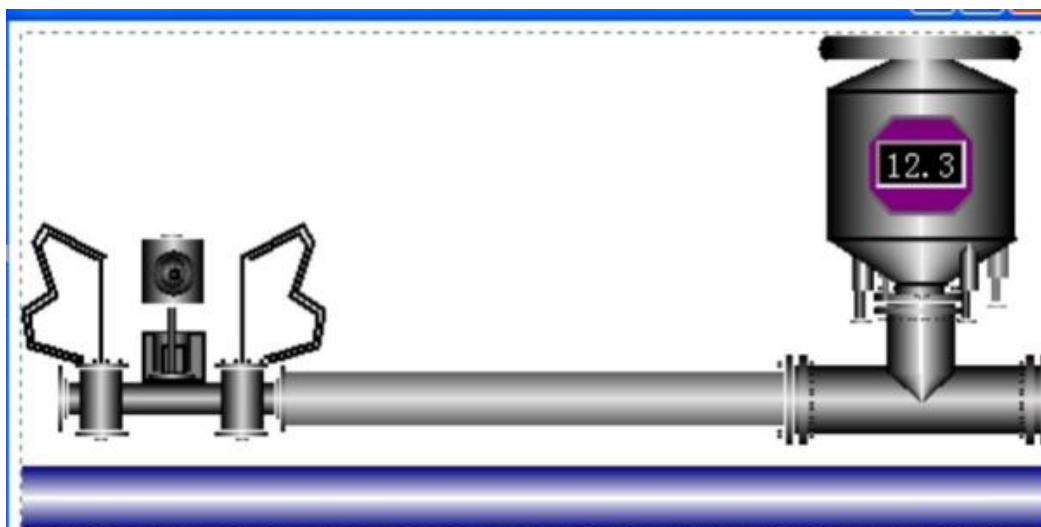

Fill color: fill the set color

Line color: the frame color

**Example:****XXXV Vertical pipes** 

Vertical pipes is used for flow definition, it can simulate the technological process on the spot and can also modification of screen display, etc.

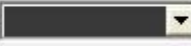
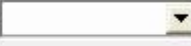
Vertical pipe Attribute

<b>Position</b> <input type="checkbox"/> Locked Left: 267 Top: 197	<b>Reg</b> Chann com: Link 1 Elem typ: D ? <input checked="" type="checkbox"/> X Moving —> RegisterD: 1 <input checked="" type="checkbox"/> Y Moving —> RegisterD: 0 <input checked="" type="checkbox"/> Visibility —> RegisterM: 0
<b>Property</b> Wide: 30 High: 100	<b>FormatSet</b> Line col:  Fill col:  

Confirm(Y) Cancel(N)



**➤Position**

Locked: lock elements, prevent well-adjusted pages from accidentally damage.

Left: coordinates of the elements in the left page.

Top: coordinates of the elements in the top page.

**➤Property**

Width: width of elements

Height: height of elements

**➤Register**

Channel connection: select communication channel.

Element type: select element type

X moving: when selected, elements will horizontally move along X axis. When the register value increase or decrease 1, the element will move one pixel towards the left or the right.

Y moving: when selected, elements will vertically move along Y axis. When the register value increase or decrease 1, the element will move one pixel towards the left or the right.

Visibility: When the set register M=ON, the component is displayed. When OFF, the component is hidden.

**➤Set Format**

Fill color: fill the set color

Line color: the frame color

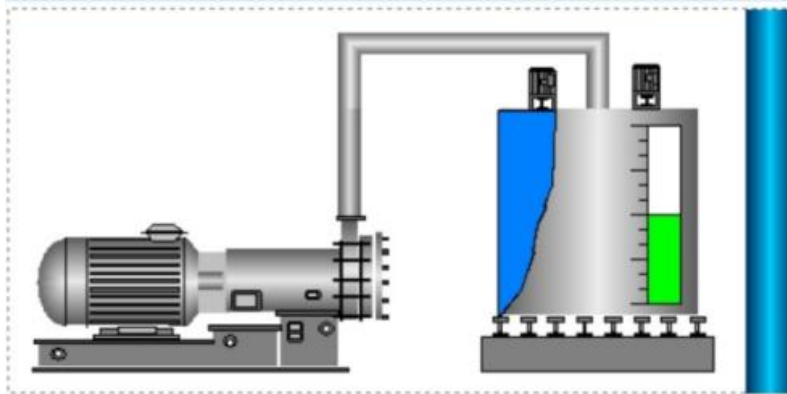
**Example:****XXXVI Pipe joint**

Pipe joint is also apply to flow chart definition, it can simulate the technological process of the scene.

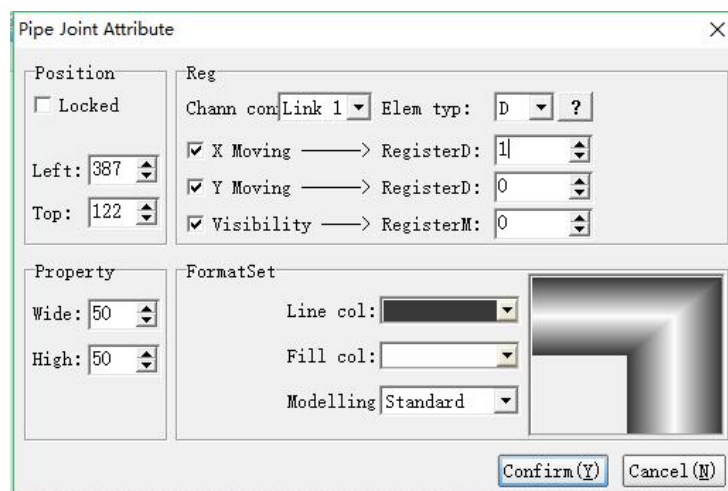
**➤Position**

Locked: lock elements, prevent well-adjusted pages from accidentally damage.

Left: coordinates of the elements in the left page

Top: coordinates of the elements in the top page.

**➤Property**

Width: width of elements

Height: height of elements

### ➤Register

Channel connection: select communication channel.

Element type: select element type

X moving: when selected, elements will horizontally move along X axis. When the register value increase or decrease 1, the element will move one pixel towards the left or the right.

Y moving: when selected, elements will vertically move along Y axis. When the register value increase or decrease 1, the element will move one pixel towards the left or the right.

Visibility: when the auxiliary contact is driven ON, the element will display. When driven OFF, the element will be hidden.

### Set Format

Fill color: fill the set color

Line color: the frame color

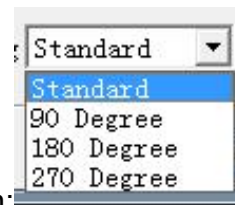

Joint model: the system provide 4 models for selection:

The effect please refer to the application.

Examples:

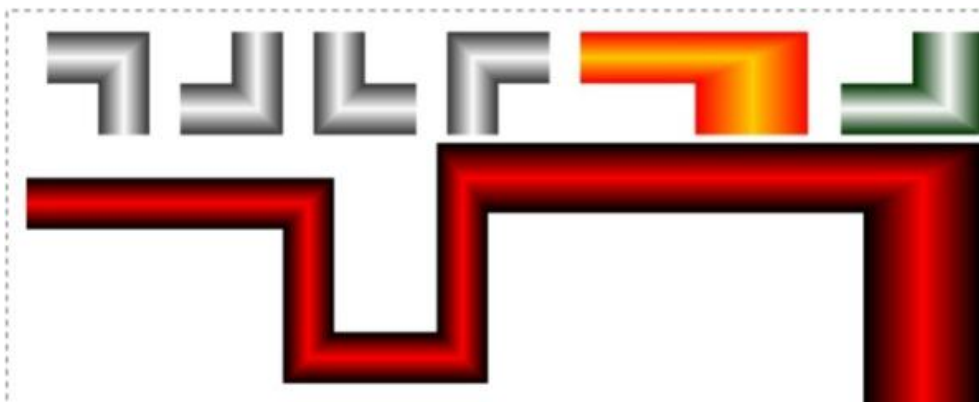

**XXXVII Scale**

Equivalent to a graduated scale. The scale direction can be changed by using the options of element type. The quantity of primary and secondary can be changed by attributing them. And the color change can be used to create unique scale.

**➤Position**

Locked: lock elements, prevent well-adjusted pages from accidentally damage.

Left: coordinates of the elements in the left page

Top: coordinates of the elements in the top page.

**➤Property**

Width: width of scale

Height: height of scale

**➤Display**

Variety: option.

Color: select color of scale

Primary scale quantity: set the quantity of main scales.

Secondary scale quantity: set the quantity of secondary scales.

**➤Set Format**

Display coordinate axis: select whether to display coordinate axis or not.

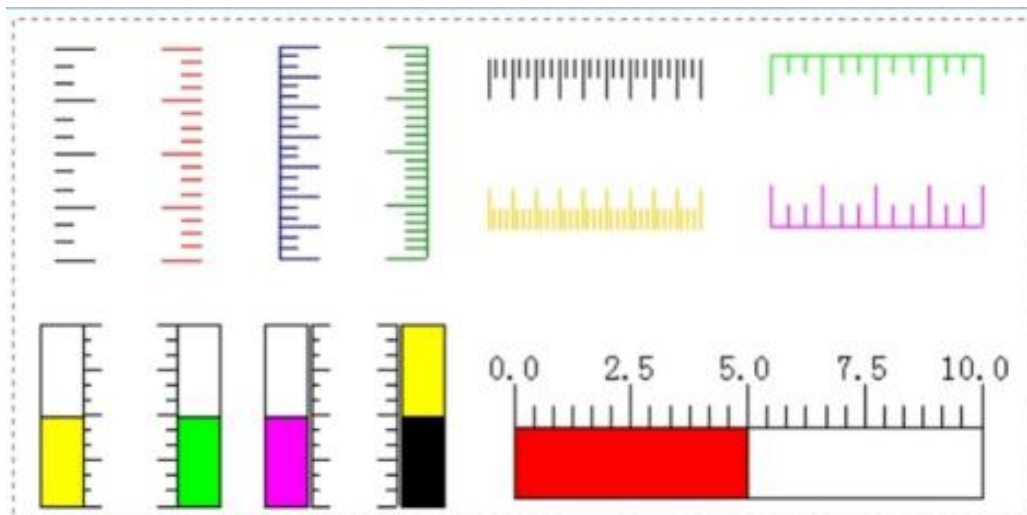
**➤Examples:**

**XXXVIII Line**

The setting of line element attribute is as below, the user can change the width and color of the line according to themselves.

The screenshot shows a 'Line Attribute' dialog box with the following fields and values:

- Position:**
  - Locked
  - X1: 192
  - Y1: 10
- Property:**
  - X2: 240
  - Y2: 58
- Show:**
  - Wide: 1
  - Colour: Black
- FormatSet:** (Empty)

Buttons: Confirm(Y), Cancel(N)

**►Position**

Locked: lock elements, prevent well-adjusted pages from accidentally damage.

X1: Coordinate of the first point

Y1: Coordinate of the first point

**►Property**

X2: Coordinate of the second point

Y2: Coordinate of the second point

**►Show**

Wide: set the width of the line

Color: set the color of the line

### ► Examples:

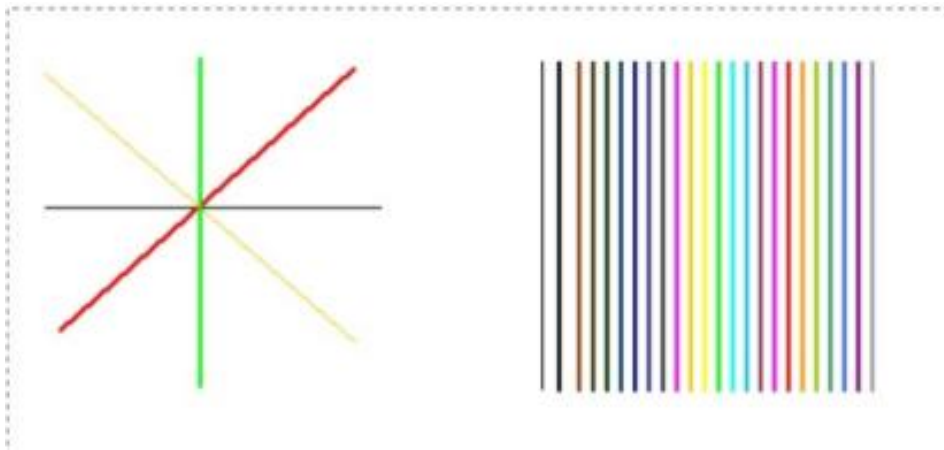

### XXXIX Ellipse



The ellipse, width and height settings determine the shape of the ellipse. If the width is equal to the height, the shape will become a circle. If it is not equal, it will become an ellipse. The long axis of the ellipse is a rectangle. Half of the longer side, the short axis is half of the shorter side of the rectangle, and the color and fill effect of the graphic can be changed.

**Ellipse Attribute** ✕

<p><b>Position</b></p> <p><input type="checkbox"/> Locked</p> <p>Left: <input type="text" value="172"/></p> <p>Top: <input type="text" value="103"/></p>	<p><b>Reg</b></p> <p>Chann con: <input type="text" value="Link 1"/> Elem typ: <input type="text" value="D"/> ?</p> <p><input checked="" type="checkbox"/> X Moving ———&gt; RegisterD: <input type="text" value="1"/></p> <p><input checked="" type="checkbox"/> Y Moving ———&gt; RegisterD: <input type="text" value="0"/></p> <p><input checked="" type="checkbox"/> Visibility ———&gt; RegisterM: <input type="text" value="0"/></p>
<p><b>Property</b></p> <p>Wide: <input type="text" value="50"/></p> <p>High: <input type="text" value="50"/></p>	<p><b>FormatSet</b></p> <p><input type="checkbox"/> Fill Line col: <input type="text" value="Black"/></p> <p>Fill col: <input type="text" value="White"/></p> <div style="border: 1px solid black; width: 100px; height: 100px; margin: 5px auto; text-align: center; line-height: 100px;">○</div>



**➤Position**

Locked: lock elements, prevent well-adjusted pages from accidentally damage.

Left: coordinates of the elements in the left page

Top: coordinates of the elements in the top page.

**➤Property**

Width: width of elements

Height: height of elements

**➤Register**

Channel connection: select communication channel.

Element type: select element type.

X moving: when selected, elements will horizontally move along X axis. When the register value increase or decrease 1, the element will move one pixel towards the left or the right.

Y moving: when selected, elements will vertically move along Y axis. When the register value increase or decrease 1, the element will move one pixel towards the left or the right.

Visibility: when the secondary contact M is driven ON, the element will display. When driven OFF, the element will be hidden.

**➤Set Format**

Fill color: when selected, the set color will be filled, otherwise only the outline border displays, other Sections will be transparent.

Line color: the border color

Fill color: the color to be filled

Fill effect: 8 special effects are provided, the effect please refer to the

application.

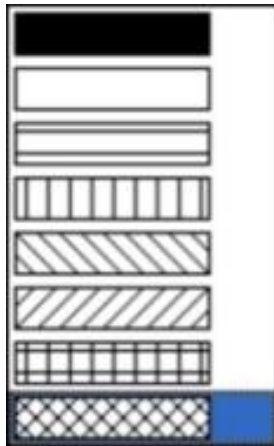

Examples:

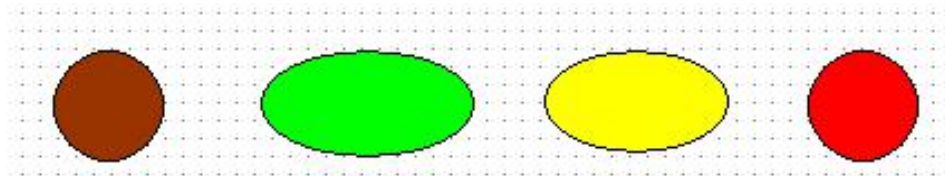

**XL Table component** 

Grid Attribute
✕

**Position**

Locked

Left:

Top:

**Show**

Wide:

Grid:

Horizontal:

Vertical:

**Property**

Wide:

High:

**FormatSet**

Edge    Line col:

                          Fill col:

**➤Position Property.**

Move Lock: Locks the component to prevent the layout from being accidentally damaged.

Left: The coordinates of the page at the far left of the component.

Top: The top of the component is at the coordinates of the page.

**➤Attribute attribute**

Width: The width of the component.

Height: The height of the component.

**➤Display attribute**

Line Width: Set the width of the table line.

Grid: Sets the color of the grid inside the table.

Number of horizontal/vertical grids: Set the number of rows and columns in the table.

**➤Format setting**

Stroke: When this function is checked, the outline of the table is drawn.

Connection color: This color works when the stroke is checked.



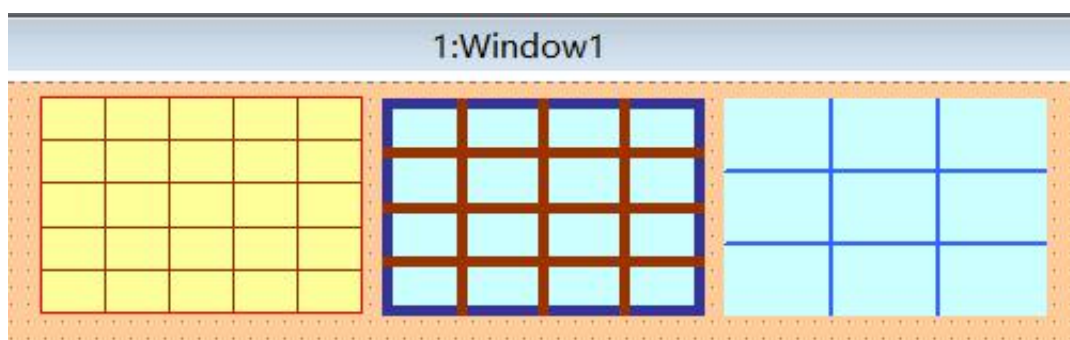

Fill color: Set the color at the bottom of the table.

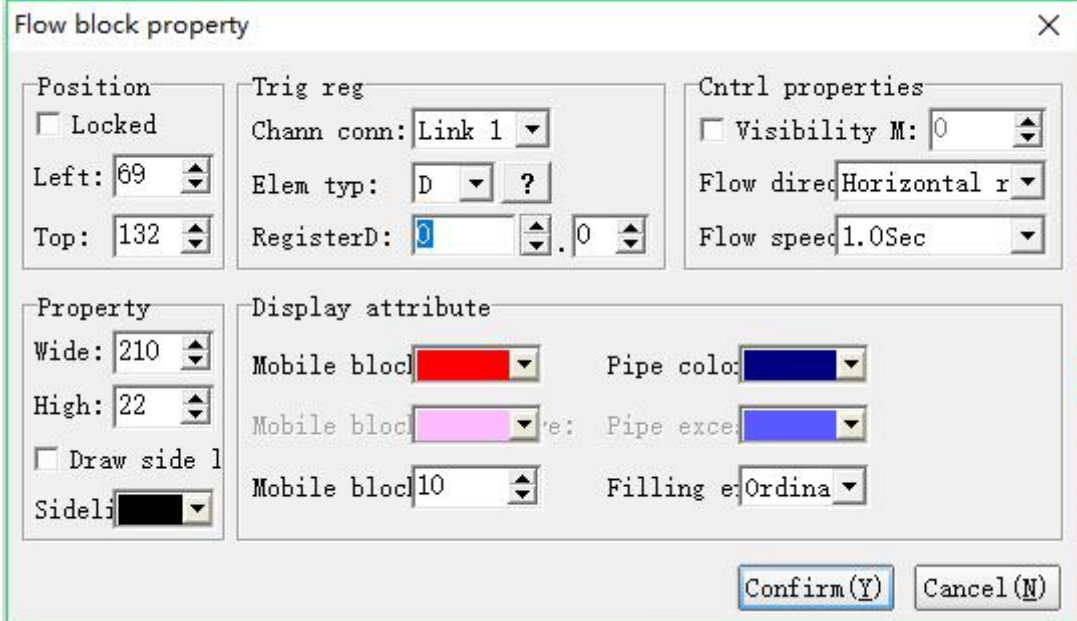
**➤Table legend**

## XL1 Flow block component



The image shows a 'Flow block property' dialog box with the following sections and controls:

- Position:**
  - Locked
  - Left: 69
  - Top: 132
- Trig reg:**
  - Chann conn: Link 1
  - Elem typ: D ?
  - RegisterD: 0 . 0
- Cntrl properties:**
  - Visibility M: 0
  - Flow direc: Horizontal r
  - Flow speed: 1.0Sec
- Property:**
  - Wide: 210
  - High: 22
  - Draw side 1
  - Sidel: 
- Display attribute:**
  - Mobile bloc: 
  - Pipe color: 
  - Mobile bloc: 
  - re: Pipe exce: 
  - Mobile bloc: 10
  - Filling e: Ordina

Buttons: Confirm (Y), Cancel (N)

### ➤ Position property

Move Lock: Locks the component to prevent the layout from being accidentally damaged.

Left: The coordinates of the page at the far left of the component.

Top: The top of the component is at the coordinates of the page.

### ➤ Attribute

Width: The width of the component.

Height: The height of the component.

Draw Edge: Check this function to stroke the color of the flow block frame.

### ➤ Trigger register attribute

Channel connection: Select the communication channel that controls playback.

Component Type: Select the type of object that controls playback.

Register Number: Select the register that controls playback.

**➤Control attribute**

Visibility control: When this function is checked, the component is visible when the set register is ON.

Flow direction: Set the flow direction of the flow block.

Flow speed: Set the flow speed of the flow block.

**➤Display attribute**

Flow Block Color: Sets the color of the flow block.

Pipe color: Set the pipe color.

Flow Block Excess: Sets the color of the overflow block. This function can be set only when the fill effect selects 3D.

Pipe Excess: Sets the color when the pipe is over. This function can be set only when the fill effect is 3D.

Number of flow blocks: Set the number of flow blocks.

Fill effect: Set the fill effect.

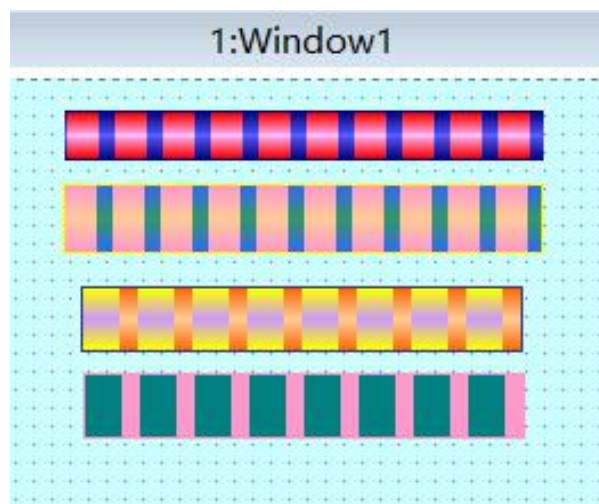
**➤Flow block legend**

## XLII Static text component

### ➤ Position property

Move Lock: Locks the component to prevent the layout from being accidentally damaged.

Left: The coordinates of the page at the far left of the component.

Top: The top of the component is at the coordinates of the page.

### ➤ Attribute

Width: The width of the component.

Height: The height of the component.

Background: The background color of the component.

Font: The font color of the component, which is the text color.

### ➤ Text attribute

Language One/Two: Set the text content of each language in static text.

### ➤ Formatting attribute

Font: Set the font for the text.

Font Size: Set the size of the text font.

Bold / Italic / Underline: Set the type of text font, which can be multi-selected.

Align: Sets the alignment of the text to the outline.

Fill: Set the type of fill.

Foreground: Set the color of the text.

### XLIII Digital display component

### ➤ Position property

Move Lock: Locks the component to prevent the layout from being accidentally damaged.

Left: The coordinates of the page at the far left of the component.

Top: The top of the component is at the coordinates of the page.

### ➤ Attribute attribute

Width: The width of the component.



Height: The height of the component.

Background: The background color of the component.

### ➤Basic attribute

Display format: Set the type of display content, which is divided into register value, system date, and system time.

Channel connection: Set the communication channel.

Component type: The type of object set.

Register Number: Set the address of the register.

Data type: 16-bit/32-bit can be selected.

Display digits: Set the number of digits of the digital tube display data.

Decimal places: Set the decimal places.

Number interval: Set the interval between the digital tube number and the number.

Pen segment width: Set the width of the number.

Background transparency: Check this function, the component background is transparent, that is, the background color is filtered out.

Off/On: Sets the color of the number when the digital tube is displayed.

### ➤Digital tube legend

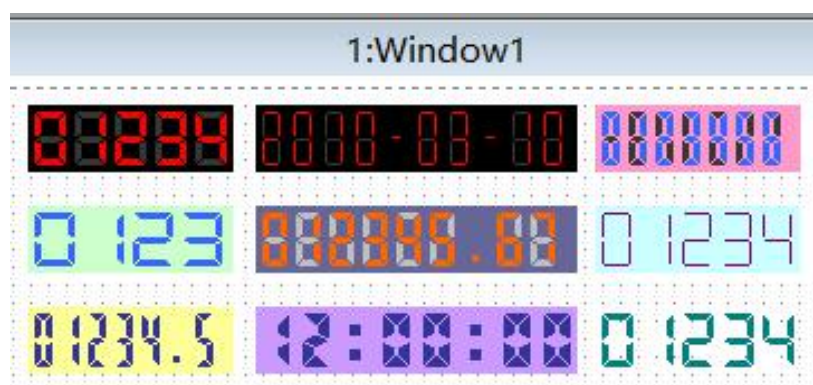

## XLIV Handpiece component

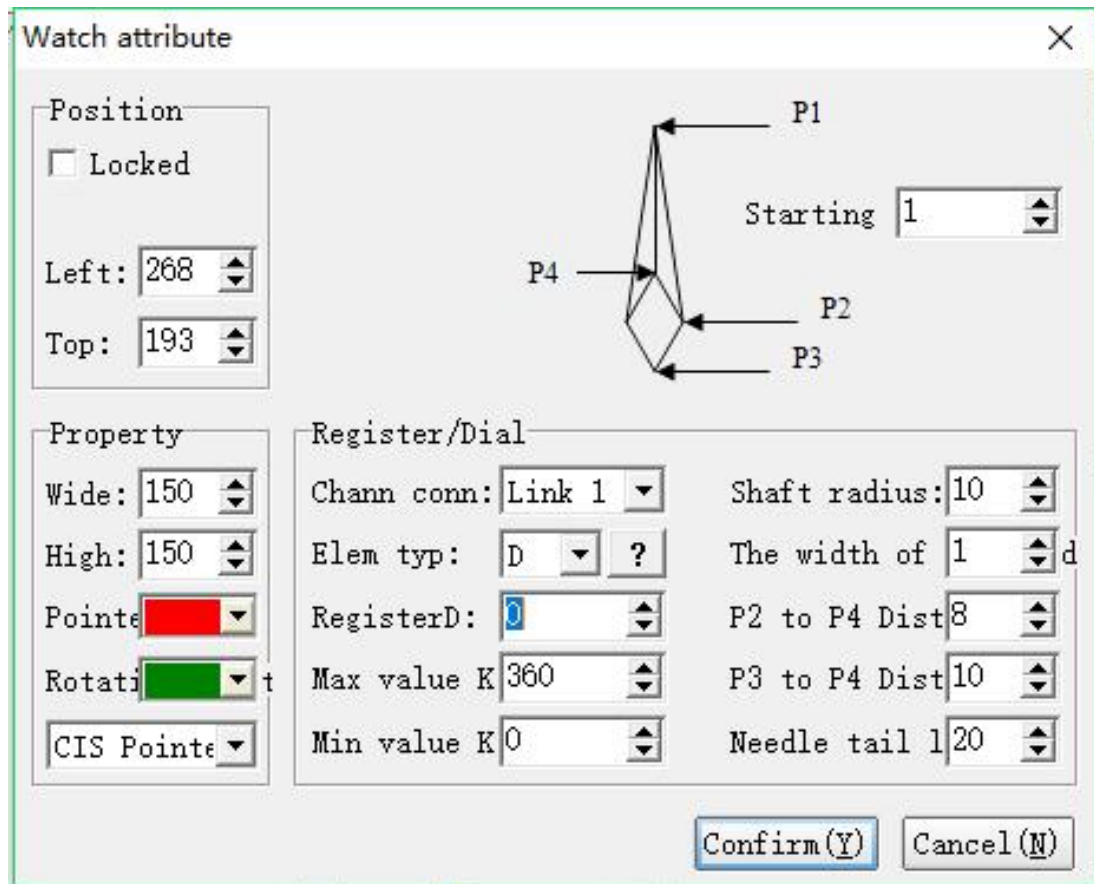

### ► Position property

Move Lock: Locks the component to prevent the layout from being accidentally damaged.

Left: The coordinates of the page at the far left of the component.

Top: The top of the component is at the coordinates of the page.

### ► Attribute attribute

Width: The width of the component.

Height: The height of the component.

Pointer: Sets the color of the component pointer.

Rotary axis: Sets the color of the component's hinge.

Drop-down box: Set the direction when the hands rotate. You can select clockwise or counterclockwise.

Starting angle: Set the starting angle of the hands.

### ➤ Basic attribute

Channel connection: Set the communication channel.

Component type: The type of object set.

Register Number: Set the address of the register.

Maximum/minimum: Set the maximum and minimum rotation of the pointer.

Radius of the shaft: Set the radius of the shaft.

Handle width: Set the width of the hands.

Distance from P2 to P4: Set the distance. As shown in the figure P2, P4

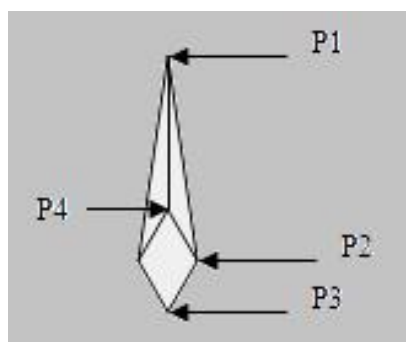

Distance from P3 to P4: Set the distance. P3, P4 as shown above

Length of the needle tail: Set the length of the needle tail.

### ➤ Needle legend

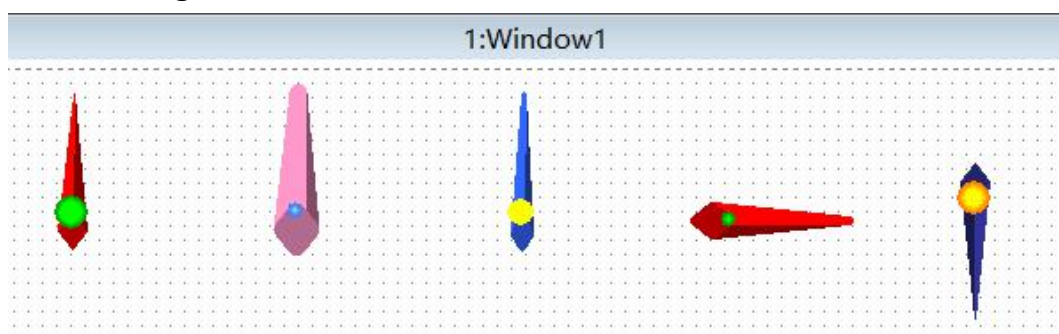

## XLV XY trend component

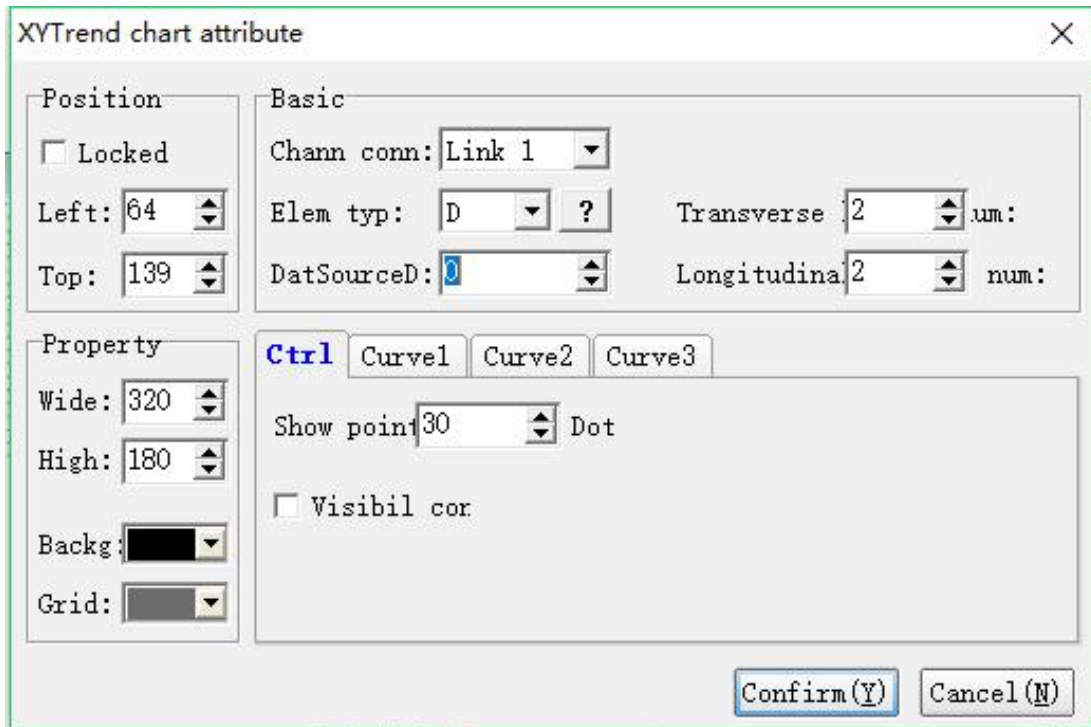

### ➤ Position property

Move Lock: Locks the component to prevent the layout from being accidentally damaged.

Left: The coordinates of the page at the far left of the component.

Top: The top of the component is at the coordinates of the page.

### ➤ Attribute attribute

Width: The width of the component.

Height: The height of the component.

Background: The background color of the component.

Grid: The color of the component table.

### ➤ Basic attribute

Channel connection: Set the communication channel.

Component type: The type of object set.

Data Source D: Set the data source for the XY plot.

### ➤Control attribute

Display points: The set line is made up of several dotted lines. Line segments representing two points are shown. That is, if all three curves are displayed, the required data is 12 data from D0 to D11, D0~D5 is the number of X coordinates of 6 data, and D6~D11 is the number of Y coordinates of 6 data; The two points of 1 are (D0, D6) (D1, D7), the two points of curve 2 are (D2, D8) (D3, D9), and the two points of curve 3 are (D4, D10) (D5, D11).

### ➤Curve 1 / Curve 2 / Curve 3. Properties

Ctrl	Curve1	Curve2	Curve3
Show:	Broken line		
Color:			
linet:	Solid		
linew:	3p		
X Max val:	1000		
X Min val:	0		
Y Max val:	1000		
Y Min val:	0		

Display: Set the display type of the curve, you can choose not to use, fold line, point.

Color: Set the color of the curve.

Line type: draw the line type of the curve, the types available for selection are as shown:



Line Width: The line width of the curve is drawn. The available line widths are as shown:

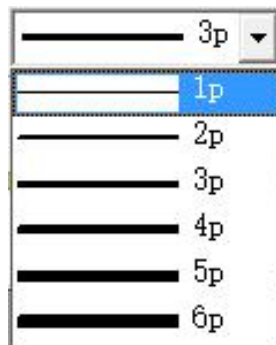

X max / min: Set the value range of X.

Y max / min: Set the range of Y.

## XLVI Sector chart component

**Fan chart** ✕

<b>Position</b> <input type="checkbox"/> Locked Left: <input type="text" value="129"/> Top: <input type="text" value="47"/>	<b>Register</b> CH. Link: <input type="text" value="Link 1"/> Data type: <input type="text" value="16Bit"/> Element type: <input type="text" value="D"/> ?      Show direction: <input type="text" value="Clockwis"/> RegisterD: <input type="text" value="0"/>	
<b>Property</b> Wide: <input type="text" value="150"/> High: <input type="text" value="150"/> Fan size: <input type="text" value="100"/> <input type="checkbox"/> Bkgrd Color <input type="checkbox"/> High flicker <input type="checkbox"/> Low flicker	<b>Control</b> <input type="checkbox"/> Indirect max: MaxVal K: <input type="text" value="65535"/> <input type="checkbox"/> Indirect min: MinVal K: <input type="text" value="0"/> Backgro: <input type="text" value="gray"/> Start angl: <input type="text" value="-20"/> Normal: <input type="text" value="red"/> End angle: <input type="text" value="200"/> Upper z: <input type="text" value="blue"/> Upper limi: <input type="text" value="80"/> % Lower z: <input type="text" value="green"/> Lower limi: <input type="text" value="20"/> %	<b>Scale</b> <input checked="" type="checkbox"/> Display sc: Dial color: <input type="text" value="black"/> Master sca: <input type="text" value="7"/> Sub scale: <input type="text" value="2"/>

### ➤ Location attribute

Move Lock: Locks the component to prevent the layout from being accidentally damaged.

Left: The coordinates of the page at the far left of the component.

Top: The top of the component is at the coordinates of the page.

#### ➤ **Attribute attribute**

Width: The width of the component.

Height: The height of the component.

Fan diameter: Set the radius of the fan.

Show background color: Shows the background color.

Blinking above the upper and lower limits: The upper and lower limit fan graphs above the setting flash.

#### ➤ **Register attribute**

Channel connection: Set the communication channel.

Component type: The type of object set.

Register number D: Set the register address.

Data Type: The type of data register, optional 16-bit/32-bit.

Display direction: Set the direction of the display, which can be set to clockwise or counterclockwise.

#### ➤ **Control attribute**

Direct maximum and minimum: Set the maximum and minimum values of the register data input, which is limited by the constant.

Indirect maximum and minimum: Set the maximum and minimum values of the register data input, which is limited by the values of other registers.

Background color: Set the background color of the pie chart.

Normal color: The color displayed by the value within the set range.

Upper Limit Zone: Sets the color that exceeds the alarm upper limit pie chart display.

Lower limit area: Set the color that exceeds the alarm lower limit pie chart display.

Starting angle: Set the angle at which the pie chart starts.



End Angle: Sets the angle at which the pie chart terminates.

Upper alarm limit: Set the upper limit of the alarm.

For example, the maximum value  $K=20$ . The upper alarm limit is set to 80%, and when  $D0=20*80\%=16$ , the pie chart displays the color of the upper limit area.

Lower alarm limit: Set the lower limit of the alarm.

For example, the minimum value  $K=0$ . The upper alarm limit is set to 20%, and when  $D0=20*20\%=4$ , the pie chart displays the color of the lower limit area.

### ➤ Scale attribute

Display Scale: Displays the scale of the pie chart.

Scale Color: Sets the color of the pie chart scale.

Main scale: Set the main division of the scale.

Sub-scale: Set the subdivision of the scale.

### XLVII QR code component

(Only supported by MT60 series touch screen)

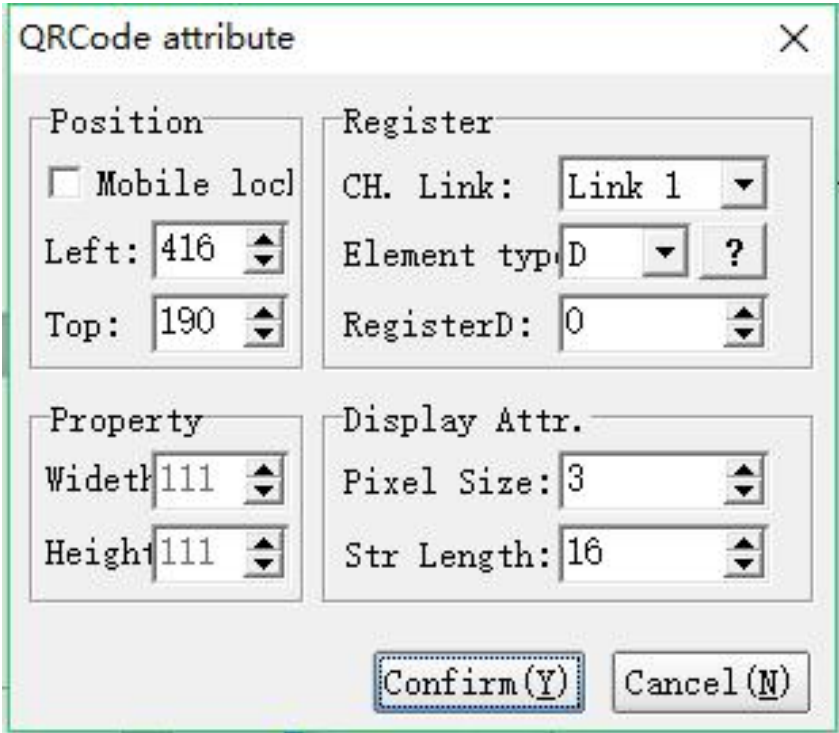

QRCode attribute

Position

Mobile loc

Left: 416

Top: 190

Register

CH. Link: Link 1

Element type: D ?

RegisterD: 0

Property

Width: 111

Height: 111

Display Attr.

Pixel Size: 3

Str Length: 16

Confirm (Y) Cancel (N)

**➤Position property**

Move Lock: Locks the component to prevent the layout from being accidentally damaged.

Left: The coordinates of the page at the far left of the component.

Top: The top of the component is at the coordinates of the page.

**➤Attribute**

Width: The width of the component.

Height: The height of the component.

**➤Register attribute**

Channel connection: Set the communication channel.

Component type: The type of object set.

Register number D: Set the register address.

**➤Display attribute**

Pixel Size: Set the size of the QR code.

String length: Set the length of the string to display.

## Chapter 4 Macros

Macro is a quite convenience and powerful function. Relatively it is easy to cause errors if people who write macro is careless. Therefore after macros are written, they should be simulate on PC online or offline, and can only be executed on HMI after being simulated for a period of time. Proper usage of macro can not only be helpful but also be time saving. If sensor units and hard drivers are used together, macros may even be economize on manpower( Similar to the automation process). At most 512 rows can be written for one macro. If there are remarks or character strings in one row, at most 50 Chinese characters can be written in this row. At most 16 sub-macro are permitted, numbers run from 1 to 16( please refer to below figure), the method of application is call " CALL sub-macro NO."

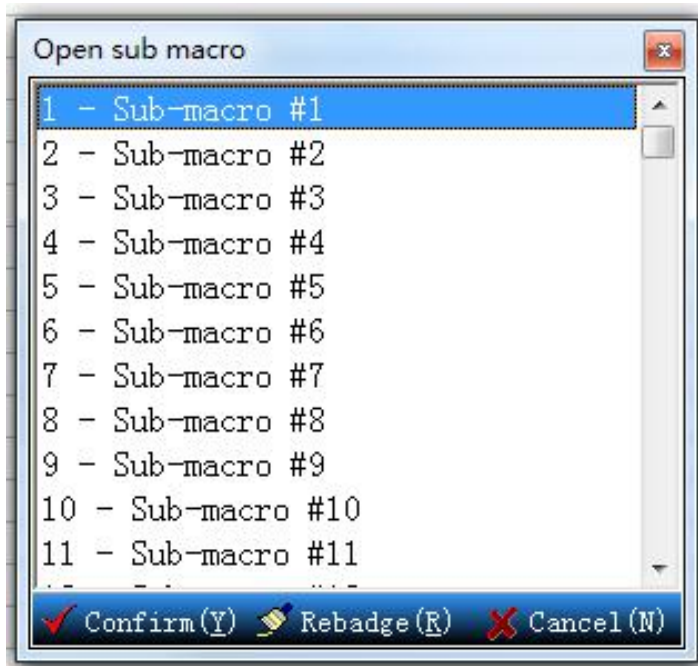

Write down the functions of sub-macros according to the different functions, thus it is convenient to manage , debug and apply these macros. The initial name of all sub-macros is Sub-macro#n, n means 1 to 16.

## I Macro Type

### 1) Initial

There is only one initial macro in a whole program or machine. It is a macro which will be executed once the program start. Therefore the values which must be executed or be set first can be lead in in advance. It can not only avoid the inconvenience of setting but also avoid the problems caused by the unknown initial value by controlling the program or machine which is similar to initial setting. If there are certain settings in PLC, initial macro can be used here. It may save users a lot of time if the macro is well designed.

### 2) Clock

There is only one clock macro in a whole program or machine, too. It may be executed repeatedly all the time and it is completed for only once. After being completed, the execution will repeat when the next Clock is triggered.

### 3) Sub

There are 16 sub-macros. The same as sub-program, users can put motions or functions with high repeatability into sub-macros. It can not only save time of writing macros but also be easily debugging.

For example, if one function is used in ten operations, this function can be written as a sub-macro. When written as sub-macro#1, the macros with this function can be solved only by written "CALL 1". If this function needs to be modified, only the sub-macro needs to be modified. It is no need to modify all the ten functions. The sub-macros can be easily managed by writing their names to represent their functions.

## II Editing of Macro

When the macro is selected, click and enter into the editing screen image, and

then it can be edited. Click one row casually, the editing window will emerge automatically and it will change according to the location you click. The numbers in the left is the number of every row.

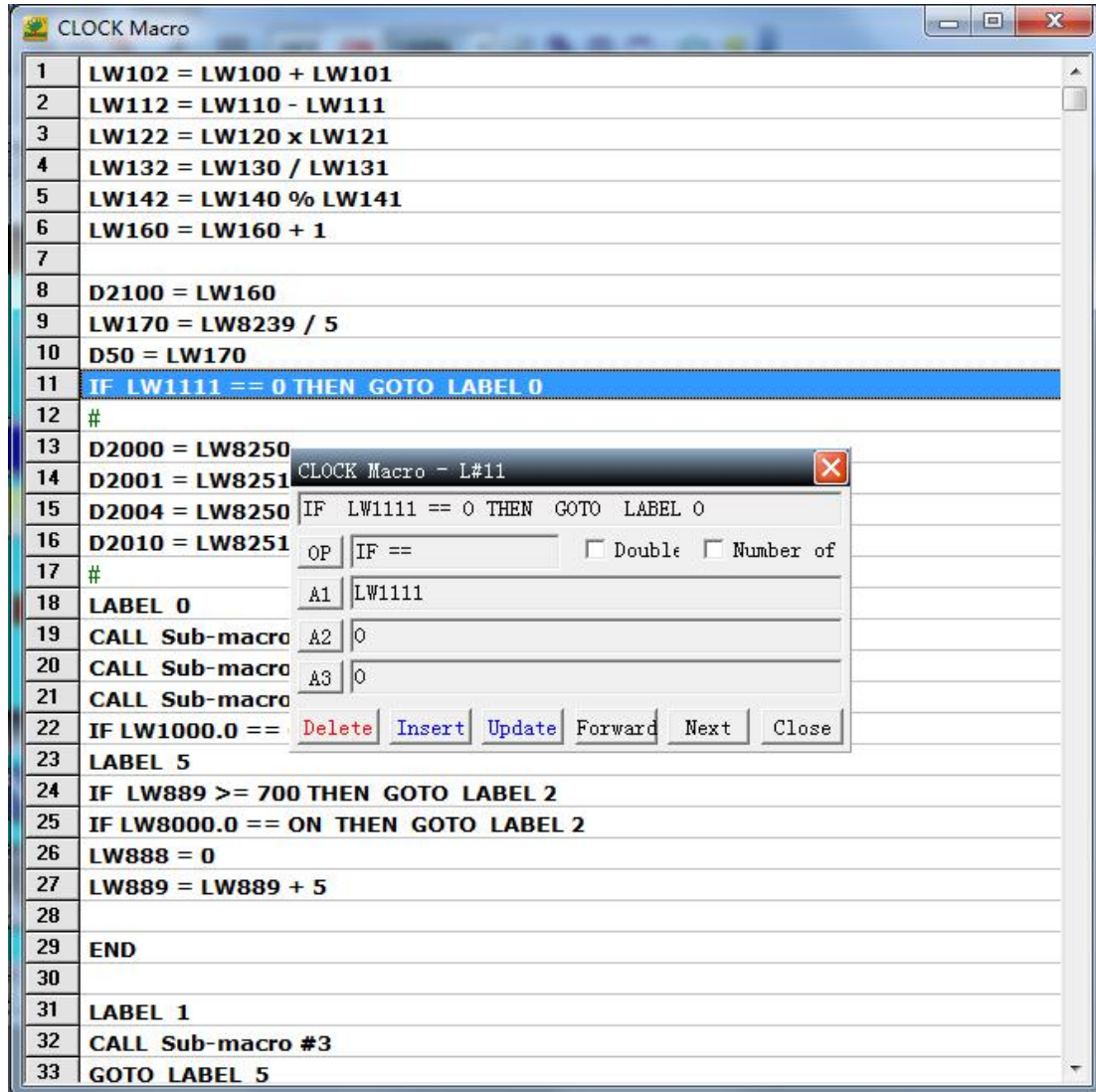

When start editing macro, you only need to click any one row, the editing window will appear ( see below figure),



and then click OP to decide the macro you needed, and then the instruction window will appear.

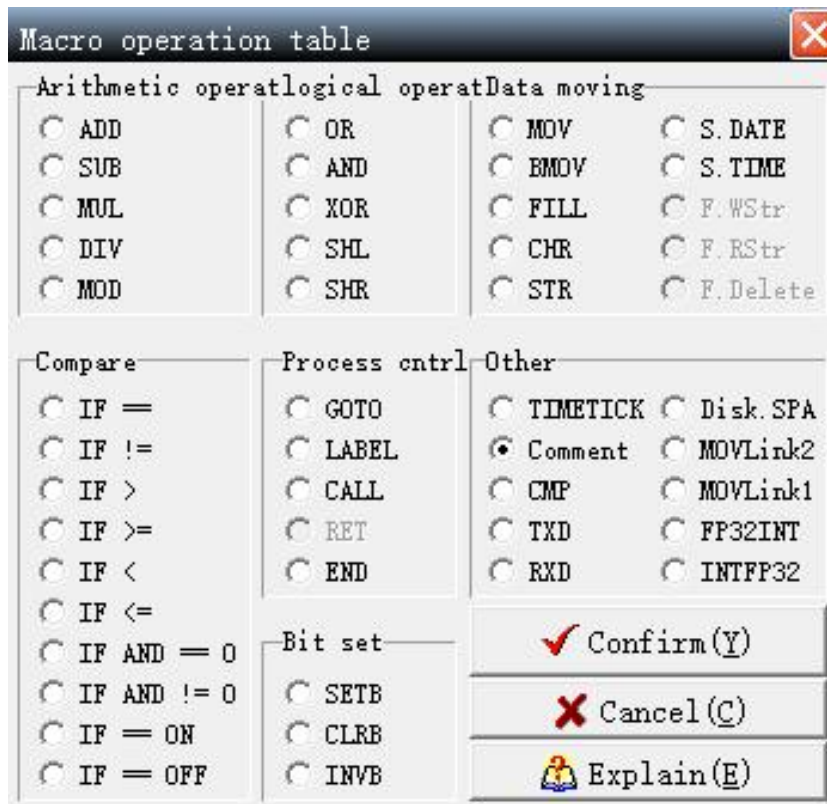

At this time, The user just move the mouse to the position of the desired command and press the OK button to return. Then click the [A1] [A2] [A3] button to edit the macro, that is, set the selected macro parameters.

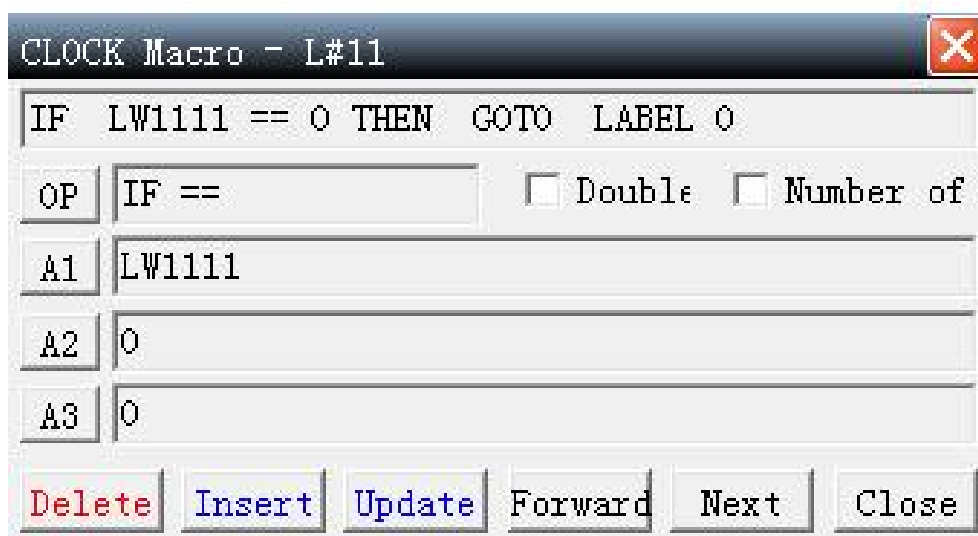

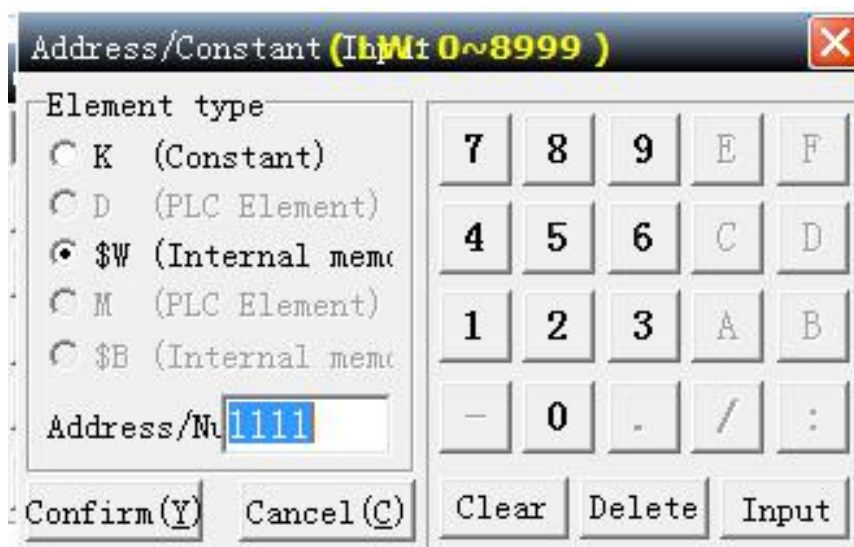
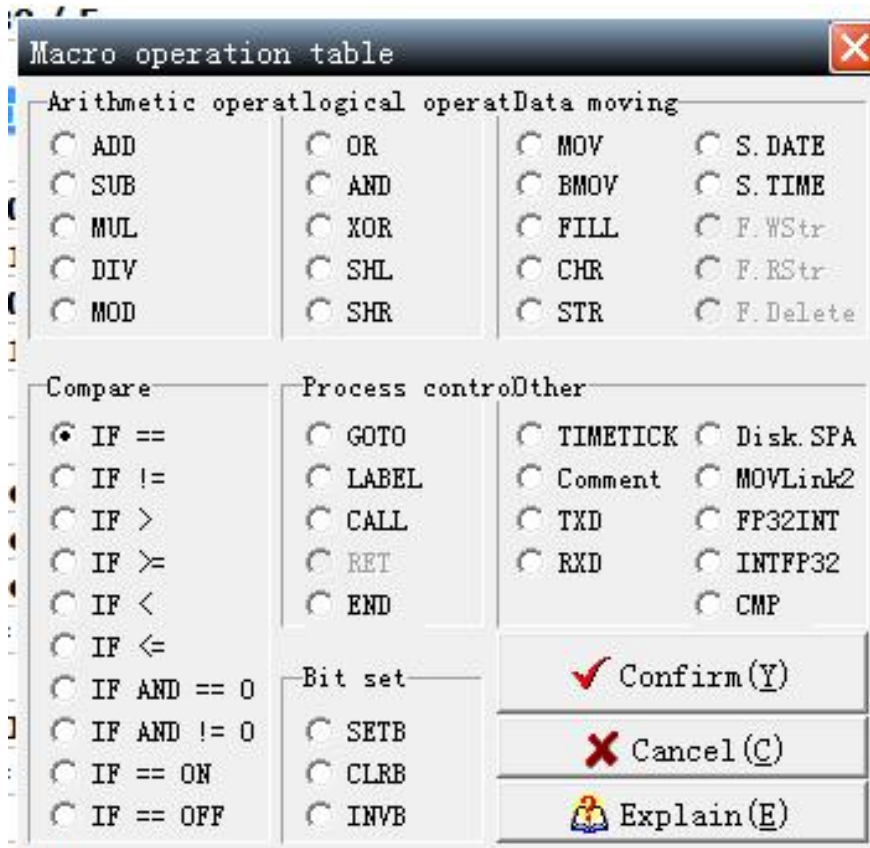

### 1) Open a macro

The function of open an old macro file is provided for users to edit macros conveniently. Users can open the saved files by using this function, no matter which manufacturer the PLC belongs to. Therefore there is no need to enter into the macros with high repeatability again, which greatly reduced the editing



time. Below is the window opened.

Undo(U)	Ctrl+Z
Recovery(E)	Ctrl+Y
Cut(T)	Ctrl+X
Copy(C)	Ctrl+C
Paste(P)	Ctrl+V
Delete(D)	
Delete all(A)	
Save(S)	
Open macro file...	Ctrl+O
Save macro file...	Ctrl+S
Print(M)	Ctrl+P
Exit	

## 2) Save a macro

The function of save as a new file is provided for users to edit macros. Users can save the current macro, no matter as a backup or in order to decrease the re-enter of other macros.

Undo(U)	Ctrl+Z
Recovery(E)	Ctrl+Y
Cut(T)	Ctrl+X
Copy(C)	Ctrl+C
Paste(P)	Ctrl+V
Delete(D)	
Delete all(A)	
Save(S)	
Open macro file...	Ctrl+O
Save macro file...	Ctrl+S
Print(M)	Ctrl+P
Exit	

### III Operand of macros

#### 1) Arithmetic operation

Arithmetic Operation: ADD,SUB,MUL,DIV and MOD(take remainders). Every operation has three operands, every operands can be the internal storage or constant(the output must be internal storage).

Unit format:Word . Double Word. Signed. Signed Double Word.

Detailed information please refer to the below diagram.

Instruction	Operation	Data form	Format	Others
ADD	A1. A2. A3	Internal Memory, constant	W. D. S	If the value of Word,(dWord) is longer than the length of them, only the value inside the range of Word,(dWord) will be recorded, others will be abanded.
SUB	A1. A2. A3	Internal Memory, constant	W. D. S	
MUL	A1. A2. A3	Internal Memory, constant	W. D. S	
DIV	A1. A2. A3	Internal Memory, constant	W. D. S	
MOD	A1. A2. A3	Internal Memory, constant	W. D. S	

W=Word. D=Double Word. S=Signed。

ADD → A1=A2+A3

E.g.: A1(Word)=A2(Word) + A3(Word)

A1(Double Word)=A2(Double Word) + A3(Double Word)

A1(Signed)=A2(Signed) + A3(Signed)

A1(Signed Double Word)=A2(Signed Double Word) + A3(Signed Double Word)

SUB →  $A1=A2-A3$

E.g.:  $A1(\text{Word})=A2(\text{Word}) - A3(\text{Word})$

$A1(\text{Double Word})=A2(\text{Double Word}) - A3(\text{Double Word})$

$A1(\text{Signed})=A2(\text{Signed}) - A3(\text{Signed})$

$A1(\text{Signed Double Word})=A2(\text{Signed Double Word}) - A3(\text{Signed$

Double Word)

MUL →  $A1=A2 * A3$

E.g.:  $A1(\text{Word})=A2(\text{Word}) * A3(\text{Word})$  。

$A1(\text{Double Word})=A2(\text{Double Word}) * A3(\text{Double Word})$

$A1(\text{Signed})=A2(\text{Signed}) * A3(\text{Signed})$

$A1(\text{Signed Double Word})=A2(\text{Signed Double Word}) * A3(\text{Signed Double$

Word)

DIV →  $A1=A2 / A3$  (A1 is quotient,  $A3 \neq 0$ )

E.g.:  $1(\text{Word})=A2(\text{Word}) / A3(\text{Word})$ 。

$A1(\text{Double Word})=A2(\text{Double Word}) / A3(\text{Double Word})$ 。

$A1(\text{Signed})=A2(\text{Signed}) / A3(\text{Signed})$ 。

$A1(\text{Signed Double Word})=A2(\text{Signed Double Word}) / A3(\text{Signed Double$

Word)

➤MOD (Take the remainder)→  $A1=A2 \% A3$  ( $A3 \neq 0$ )

$A1(\text{Word})=A2(\text{Word}) \% A3(\text{Word})$ 。

$A1(\text{Double Word})=A2(\text{Double Word}) \% A3(\text{Double Word})$ 。

$A1(\text{Signed})=A2(\text{Signed}) \% A3(\text{Signed})$ 。

$A1(\text{Signed Double Word})=A2(\text{Signed Double Word}) \% A3(\text{Signed Double$

Word)

## 2) Logical operation

Logic Operation: OR,AND,XOR,SHL and SHR. Every operation has three operands, every operands can be the internal storage or constant(the output must be internal storage).

Unit format: Word . Double Word.

Detailed information please refer to the below diagram.

Instructio n	Operation	Data form	Format	Others
OR	A1. A2. A3	Internal Memory, constant	W. D	
AND	A1. A2. A3	Internal Memory, constant	W. D	
XOR	A1. A2. A3	Internal Memory, constant	W. D	
SHL	A1. A2. A3	Internal Memory, constant	W. D	
SHR	A1. A2. A3	Internal Memory, constant	W. D	

W=Word. D=Double Word

OR →  $A1=A2 | A3$

$A1(\text{Word})=A2(\text{Word})|A3(\text{Word})$  or  $A1(\text{dWord})=A2(\text{dWord})|A3(\text{dWord})$

A	B	F
0	0	0
0	1	1
1	0	1
1	1	1

AND →  $A1=A2 \& A3$

$A1(\text{Word})=A2(\text{Word})\& A3(\text{Word})$  or  $A1(\text{dWord})=A2(\text{dWord})\& A3(\text{dWord})$

A	B	F
0	0	0
0	1	0
1	0	0
1	1	1

XOR →  $A1=A2 \wedge A3$

$A1(\text{Word})=A2(\text{Word})\wedge A3(\text{Word})$  or  $A1(\text{dWord})=A2(\text{dWord})\wedge A3(\text{dWord})$

A	B	F
0	0	0
0	1	1
1	0	1
1	1	0

SHL →  $A1=A2 \ll A3$

$A1(\text{Word})=A2(\text{Word}) \ll A3(\text{Word})$

Left shift is to fill 0 into bit0 while shifting out bit15. If  $A3 > 16$ ,  $A1=0$

$A1(\text{dWord})=A2(\text{dWord}) \ll A3(\text{dWord})$

Left shift is to fill 0 into bit0 while shifting out bit31. If  $A3 > 32$ ,  $A1=0$

SHR →  $A1=A2 \gg A3$ 。

$A1(\text{Word})=A2(\text{Word}) \gg A3(\text{Word})$

Left shift is to fill 0 into bit15 while shifting out bit0. If  $A3 > 16$ ,  $A1=0$

$A1(\text{dWord})=A2(\text{dWord}) \gg A3(\text{dWord})$

Left shift is to fill 0 into bit31 while shifting out bit0. If  $A3 > 32$ ,  $A1=0$

### 3) Data Shift

Data shift: MOV,BMOV,FILL and CHR.Detailed information please refer to the below diagram(the output can only be the internal storage).

Instruction	Operation	Data form	Format	Others
MOV	A1. A2	Internal Memory, Constant, PLC	W. D	A1 has only internal storage and PLC
BMOV	A1. A2. A3	Internal Memory, Constant, PLC	W. D	A1 and A2 have only internal storage and PLC
FILL	A1. A2. A3	Internal Memory, constant	W. D	A1 has only internal storage
CHR	A1. A2	Internal Memory, constant	W	A2 is input string
STR	A1. A2. A3	Internal Memory, constant	W	A1 has only internal storage
S.DATE	A1	Internal Memory	W	A1 has only internal storage
S.TIME	A1	Internal Memory	W	A1 has only internal storage

W=Word. D=Double Word.

➤MOV → A1(Word)= A2(Word) or A1(DWord)= A2(DWord)

MOV is to copy data in A2 to the target buffer A1, and data in A2 will not be changed. If A1 is the address of PLCs, data in A2 is written in the address by communication. Otherwise, if A2 is the address of PLC, data of A2 is read out by communication and then move to A1.

➤BMOV → BMOV(A1,A2,A3).

BMOV is to move A2 to A1, move the value of A3 in total. Word is the only format. Start from A2, copy the data of the buffers with the value of A3 to buffers initialed from A1, and data in A2 will not be changed. **The Maximum effective value of A3 is 30. No matter A3 is a direct or indirect data, if the effective value is greater than 30, it will be dealt with 30.** If the length of the block is greater than the Maximum value of internal storage or PLC, this instruction will be given up executing.

➤FILL → FILL(A1,A2,A3).

Fill the value of A2 from A1, there are the value of A3 in total, Start from A2, fill the data of the buffers with the value of A3 to buffers initialed from A1, and data in A2 will not be changed. If the length of the block is greater than the Maximum value of internal storage or PLC, the compiling will not be passed.

➤CHR → ASCII (text), such as CHR (A1, "A2").

Convert the characters in A2 into ASCII and then store them in A1. The maximum length of the character string is 50 characters.

➤STR→ASCII (Integer), such as STR (A1,A2,A3), Mostly used for printer functions.

The integer in the A2 address is converted to an ASCII string and placed at the address specified by A1. The decimal point is specified by A3. The data format is only Word (1 Word = 2 characters / 1 Chinese).

➤S.DATE→Date, A1= S.DATE().

The current date of the system is converted to a string and stored in the register address specified by A1. The format of "YYYY-MM-DD" occupies 5 Words. It is recommended that A1 use a variable text component.



➤S.TIME→Time, A1= S.TIME()

The current time of the system is converted to a string and stored in the register address specified by A1. The format of "HH:MM:SS" occupies 4 Words.

Recommendation A1 uses variable text components

#### 4) Compare

Compare:IF==. IF !=. IF >. IF >=. IF <. IF <=. IF AND == 0. IF AND != 0. IF == ON,IF == OFF,etc.

Detailed information please refer to the below diagram.

Instruction	Operation	Data form	Format	Others
IF==	A1. A2. A3	Internal Memory, Constant	W. D. S	A3 has only constant
IF !=	A1. A2. A3	Internal Memory, Constant	W. D. S	A3 has only constant
IF >	A1. A2. A3	Internal Memory, constant	W. D. S	A3 has only constant
IF >=	A1. A2. A3	Internal Memory, constant	W. D. S	A3 has only constant
IF <	A1. A2. A3	Internal Memory, constant	W. D. S	A3 has only constant
IF <=	A1. A2. A3	Internal Memory, constant	W. D. S	A3 has only constant

IF AND == 0	A1. A2. A3	Internal Memory, constant	W. D	A3 has only constant
IF AND != 0	A1. A2. A3	Internal Memory, constant	W. D	A3 has only constant
IF ==ON	A1. A2	Internal Memory, constant	B	A1 has only PLC and Internal Memory, A2 has only constant
IF == OFF	A1. A2	Internal Memory, constant	B	A1 has only PLC and Internal Memory, A2 has only constant

W=Word. D=Double Word. S=Signed. B=Bit.

IF == → e.g. IF A1==A2 THEN GOTO LABEL A3. Format of Signed DW can be used.

IF != → e.g. IF A1!=A2 THEN GOTO LABEL A3. Format of Signed DW can be used.

IF > → e.g. IF A1>A2 THEN GOTO LABEL A3. Format of Signed DW can be used.

IF >= → e.g. IF A1>=A2 THEN GOTO LABEL A3. Format of Signed DW can be used.

IF < → e.g. IF A1<A2 THEN GOTO LABEL A3. Format of Signed DW can

be used.

IF <= → e.g. IF A1<=A2 THEN GOTO LABEL A3 . Format of Signed DW can be used.

IF AND == 0 → e.g. IF (A1&A2)== 0 THEN GOTO LABEL A3 . Format of Signed DW can be used.

IF AND != 0 → e.g. IF(A1&A2) != 0 THEN GOTO LABEL A3. Format of Signed DW can be used.

IF == ON → e.g. IF A1==ON THEN GOTO LABEL A2.

IF ==OFF → e.g. IF A1==OFF THEN GOTO LABEL A2.

## 5) Process Control

Process Control: GOTO. LABEL. CALL. RET and END , detailed information please refer to the below diagram.

Instruction	Operation	Data form	Format	Others
GOTO	A1	constant		
LABEL	A1	constant		
CALL	A1	constant		
RET	N/A			
END	N/A			

➤ GOTO → e.g. GOTO LABEL A1. LABEL A1 must in the same program. An unconditional jump instruction will cause a branch to jump to the label specified inside the program (LABEL A1), and the specified LABEL A1 must be within the program.

➤ LABEL → e.g. LABEL A1.

Labels in the same macro program cannot be the same. However, different macros can assign the same label.

➤ CALL → Call Sub-macro, e.g. CALL A1.

Call Sub-macro can transfer the right of control to program instructions of macro. Normally macros are used to execute certain function. pass parameters tables. operate a set of instructions and so on. Please note that sub-macros must be exist and they must be returned by a RET instruction at the end of the program. The RET instruction will transfer the right of control to the instruction in the next row which is under the original sub-macro. The number of Sub-macros can start from 01~16, the name of sub-macro can be customized.

➤ RET → return to macro

RET is only used in Sub-macros, but CALL is placed in main programs. There must be a CALL corresponding to every RET.

➤ END → End Macro

END means a macro is ended. The macro after END will not be executed. It will start from the instructions in the first row.

Important note: The END command represents the end of the macro.

## 6) Bit Set

Bit Set: SETB. CLRBL and INVB ,

detailed information please refer to the below diagram.

Instruction	Operation	Data form	Format	Others
SETB	A1	PLC, Internal Memory	Bit	
CLRBL	A1	PLC, Internal Memory	Bit	
INVB	A1	PLC, Internal Memory	Bit	

SETB →set BIT ON,Usage: SETB A1

CLRB →set BIT OFF,Usage: CLRB A1

INVB →reversely set the state of BIT ,Usage: INVB A1

## 7) Others

There are TIMETICK and Comment,CMP. TXD. RXD. Disk.SPA. MOVLink2.

MOVLink1. FP32INT. INTFP32 etc 10 commands

Instruction	Operation	Data form	Format	Others
TIMETICK	A1	Internal Memory	W. D	
Comment	A1	Character String		
CMP	A1 A2 A3	Internal Memory,Consta nt	W. D. S	
TXD	A1 A2	Internal Memory,Consta nt	W	
RXD	A1 A2	Internal Memory,Consta nt	W. D	
Disk.SPA	A1	Internal Memory	W	
MOVLINK2	A1 A2	PLC,Internal Memory	W. D	
MOVLINK1	A1 A2	PLC,Internal Memory	W. D	
FP32INT	A1 A2	PLC,Internal Memory	W. D. F	

INTFP32	A1 A2	PLC,Internal Memory	W. D. F	
---------	-------	------------------------	---------	--

➤TIMETICK → get the time of the system(CPU operation time ),put in the selected address,increase 1 means increase 100ms.

➤Comment → increase readability of macros,but has no effect to macros actually.

➤CMP → block comparison, such as: CMP (A1, A2, A3)

Refers to the continuous A3 number register starting from the A1 address and the consecutive A3 number registers starting from the A2 address. The comparison result is stored in the A1+A3 address register, comparing the exact match result ==1, otherwise the result ==0; A3 setting Maximum == 50.

➤TXD → Send data such as: TXD (A1, A2). <The communication protocol must be Free Protocol>

It means sending data from the A1 address to the UART port corresponding to the LINK1/LINK2 selection, and sending A2 bytes in total. The data format is only Word (1 Word=2 bytes).

➤RXD → Receive data such as: RXD (A1, A2). <The communication protocol must be Free Protocol>

Refers to the UART port selected by LINK1/LINK2 to receive data to the start address specified by A1, and A2 refers to the number of read bytes. If A2 specifies K, it specifies to read K bytes; if A2 specifies LW, it reads all the bytes of the buffer (256 bytes), so the address value of A2 must be  $\geq A1+255$ . The data format is stored in the A2+1 address. The setting setting A2+1=0: indicates that the received data is arranged in bytes; setting A2+1=1: indicating

that the received data is arranged in words, the high byte is in front; A2+1=2:  
Indicates that the received data is arranged in words. The low byte is first;

➤Disk.SPA → Take the remaining space of the disk. For example:

A1=Disk.SPA()

Take the remaining free space value of the internal disk and store it in the register address specified by A1. The unit is 0.1MB and one Word is used.

➤MOVLink2 → Pass Link2 data such as: A1 = A2 [Link2]

The data in Link2 that communicates with the screen is transmitted to the internal register of the screen or to the register in Link1 that communicates with the screen.

As shown in the figure below, the touch screen communicates with the PLC through Link2. When the condition of the internal register LW200 = 111 is satisfied, the program will transfer the data of the register D10 in the Link2 PLC to the register LW100 inside the screen.

 CLOCK Macro

1	<b>IF LW200 == 111 THEN GOTO LABEL 1</b>
2	<b>END</b>
3	
4	<b>LABEL 1</b>
5	<b>LW100 = D10 [Link2]</b>
6	<b>END</b>
7	

➤MOVLink1 → Pass Link1 data such as: A1[Link2]=A2

Pass the data in the screen or the data in Link1 that communicates with the screen to the register set in Link2 of the screen communication.

As shown in the figure below, the touch screen is connected to two PLCs and is distinguished by Link1 Link2. When the condition of LW200 = 11 is satisfied, the program will transfer the data of



register D10 in Link1 PLC to register D0 in Link2 PLC.

The screenshot displays a ladder logic macro titled "CLOCK Macro" with the following steps:

```

1 IF LW200 == 111 THEN GOTO LABEL 1
2 END
3
4 LABEL 1
5 LW100 = D10 [Link2]
6 END
7
8
9
10
11
12
13
14
15
16

```

Step 5, "LW100 = D10 [Link2]", is highlighted in blue. A configuration dialog box titled "CLOCK Macro - L#5" is overlaid on the screen, showing the details for this step:

- OP: MOVLink2
- A1: LW100
- A2: D10 (highlighted with a pink box)
- A3: (empty)
- Buttons: Delete, Insert, Update, Forward, Next, Close

➤FP32INT → Convert floating point numbers to integers such as:

FP32INT(A1,A2)

Convert the floating point number of A2 to an integer and put it in A1. A1 must be set to an integer type.

➤INTFP32 → integer conversion to floating point number For example:

INTFP32 (A1, A2)

Convert the floating point number of A2 to an integer and put it in A1. A1 must be set to a floating point type.

## IV Errors

### 1) LABEL undefined

This message means the label that GOTO needed cannot be found. See below figure:



### 2) LABEL Repeat

This message means that there are the same label no. in this program. See below figure:



## Chapter 5 System Control Area

HMI system pause area and state respond buffer must be defined so that MT series can communicate with PLCs with other brands and display screen images bidirectional.

Click [parameter setting] in [Application] dialog box, or click the icon  in the toolbar, or use the defaulted hotkey F7.

The communication port COM1 is 232 communication, and COM2 is 485 communication. (Note: MT90 series COM1 is 232/485 communication, COM2 is 232 communication)

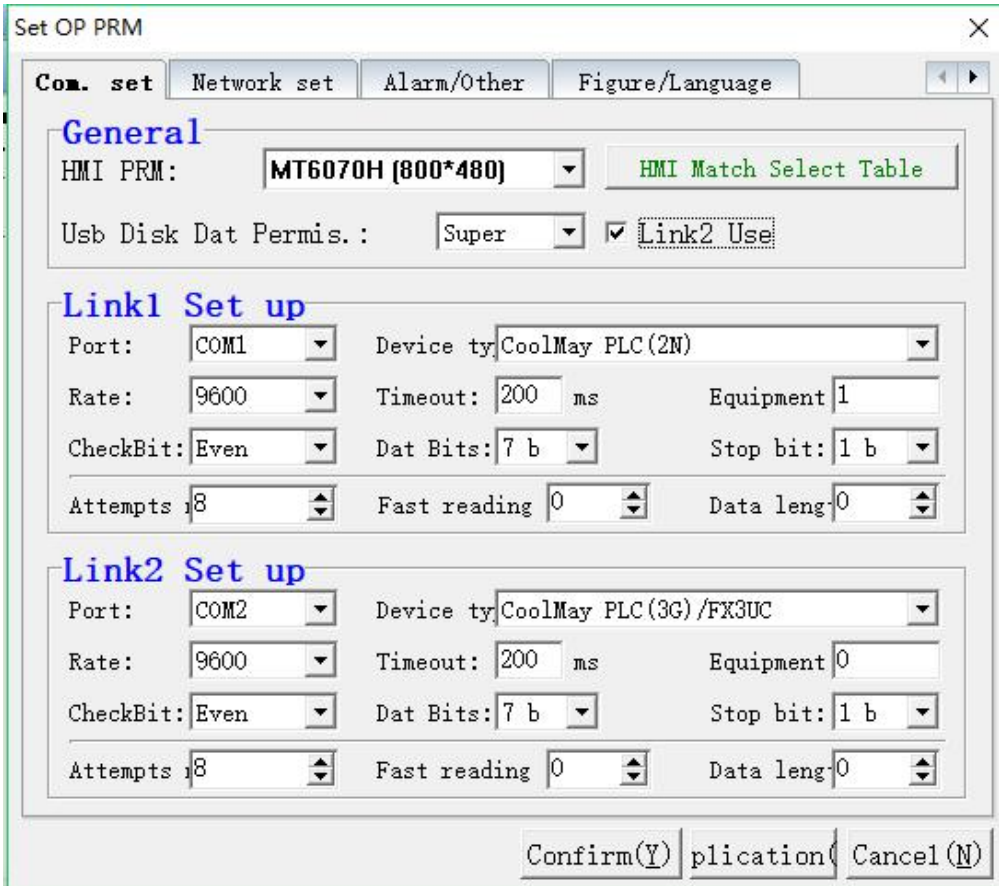

The screenshot shows the 'Set OP PRM' dialog box with the following settings:

- General:**
  - HMI PRM: MT6070H (800\*480)
  - Usb Disk Dat Permis.: Super
  - Link2 Use:
- Link1 Set up:**
  - Port: COM1
  - Device ty: CoolMay PLC (2N)
  - Rate: 9600
  - Timeout: 200 ms
  - Equipment: 1
  - CheckBit: Even
  - Dat Bits: 7 b
  - Stop bit: 1 b
  - Attempts: 8
  - Fast reading: 0
  - Data leng: 0
- Link2 Set up:**
  - Port: COM2
  - Device ty: CoolMay PLC (3G)/FX3UC
  - Rate: 9600
  - Timeout: 200 ms
  - Equipment: 0
  - CheckBit: Even
  - Dat Bits: 7 b
  - Stop bit: 1 b
  - Attempts: 8
  - Fast reading: 0
  - Data leng: 0

Buttons at the bottom: Confirm(Y), Application, Cancel(N)

### I Parameters

#### ➤ Communication Setting Conditions of program updating

In order to prevent the controller from starting in the mode of semi-automatic/automatic or when the motor is turned on, updating the HMI

program, resulting in poor quality of products and unexpected accidents due to the sudden change of parameter settings. The program can only be updated in the manual mode or when the motor is turned off.

➤ Communication Setting Usage of link2

Choose whether to use Link2 or not. MT series HMI support 2 different kinds of controllers to communication simultaneously. For example, Link1 connect with CoolMay PLC(2N), Link2 connect with Omron C Series PLC.

➤ Communication Setting Times of connection attempts

When the setting of communication is failed, times of connection attempts will be auto-repeated. When the times is over the setting value , the HMI will stop connecting and give an

alarm”communication failed”.

➤ Communication Setting Fast reading area

This setting can improve the quick update display of DATA data when the man-machine interface and PLC are actually connected. Because of the normal design of the screen, some PLC data addresses may be scattered rather than continuous. In order to get the best data update effect and ensure the correct communication, it is recommended that the PLC data address be continuous without interruption. The data displayed in the range of the fast reading area will display much faster than the data outside the range.

In addition, system program update conditions, automatic conversion display screen, voice control, history curve, clock pulse (trigger condition), clock counter (count condition), data save (data source), history list, alarm list, LED indicator The data must also be within the fast read range, otherwise the system will not actively read the data of the above components.

## II Network Setting

The screenshot shows the 'Set OP PRM' dialog box with the 'Network set' tab selected. The settings are as follows:

- RS485/CAN\_Bus Multi com.:**
  - Cntrlr ID addr. mod: Standard
  - Extded com. ID swit: 35
  - Extended mode intin: 1
  - adr.Each ID addr. reg N: 100
- Ethernet settings:**
  - Remote IP2: 222.222.222.222
  - Remote IP3: 222.222.222.222
  - Remote IP4: 222.222.222.222
- System time auto sync:**
  - Auto sync function:
  - Syn. interval (Hou): 12
  - From reg No. D: 200
  - \*Take 6 consecutive reg HH:MM:SS YY+
- Interactive:**
  - Auto transformation displa:  Link 1 Reg No.D: 2180
  - Report current pic. No.:  Link 1 Reg No.D: 1180

Buttons at the bottom: Confirm(Y), Application, Cancel(N).

➤RS485/CAN\_Bus multi-controller communication ID address mode

“Standard/Extension” optional. “Standard” apply to the situation when one HMI is connected with one PLC. “Extension” apply to the situation when one HMI is connected with multiply PLCs. Coolmay HMI support “Extension”, namely one HMI can connect with registers of multiply PLCs through RS422/485, please note that PLCs in the same line must be the same brand or must support the same communication protocol and register address. Since RS232 doesn’t support one HMI communicating with multiple PLCs simultaneously, when there isn’t RS422 or RS485, RS232 should be converted to RS422 or RS485 by communication adapter. The specific hardware connection differs along with different PLCs. Below are two normal applications.

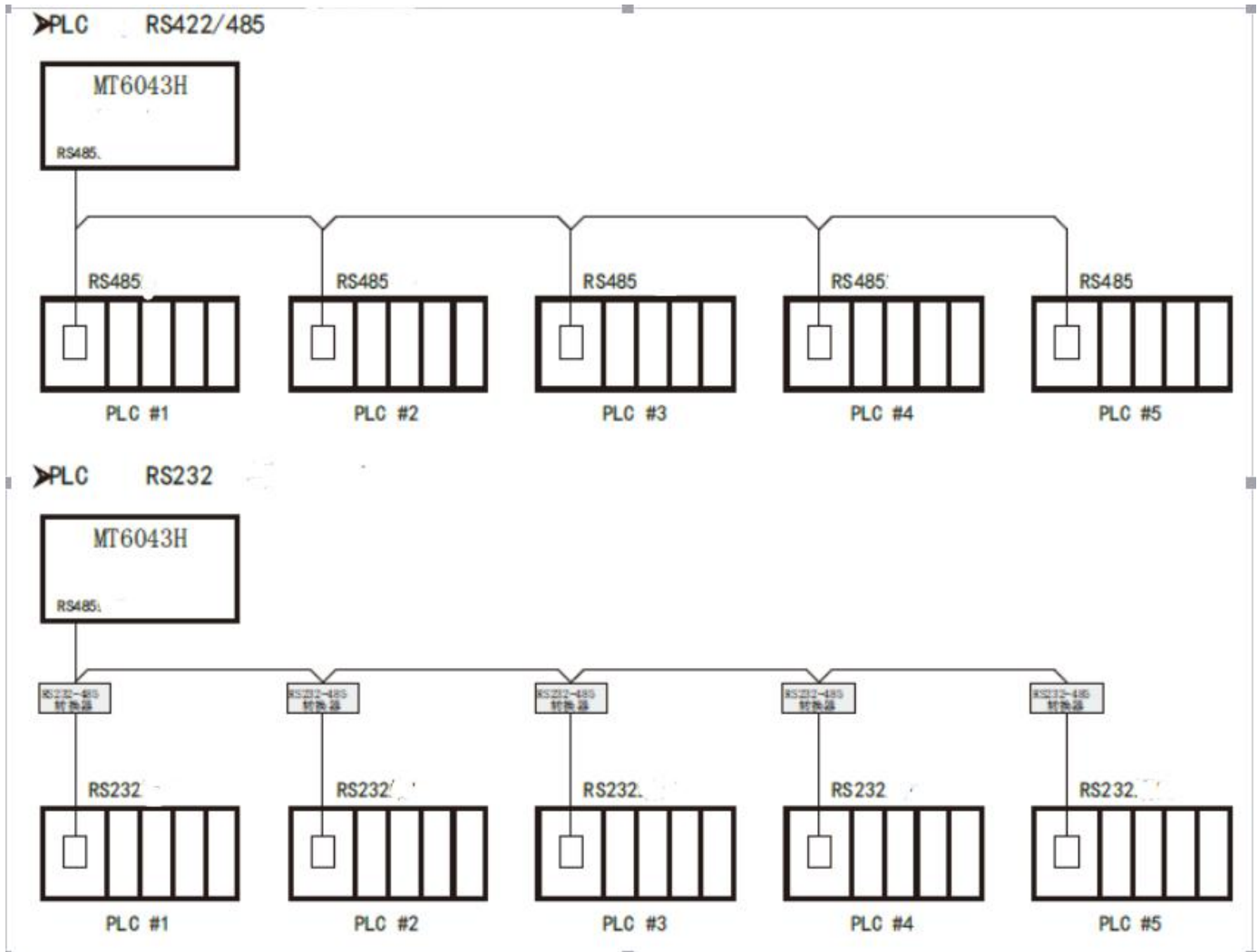

➤RS485/CAN\_Bus multi-controller communication. Initial ID address of extension

It is effective when the ID address is “extension”, the initial ID address of extension is the same with the ID address of the initial PLC in the main line.

➤RS485/CAN\_Bus multi-controller communication Registers quantity of every ID address

It is effective when the ID address is “extension”, the register quantity of every ID address is the same with the register quantity every PLC in the main line occupied. For example, initial ID address of extension=0, registers quantity of every ID address=100.

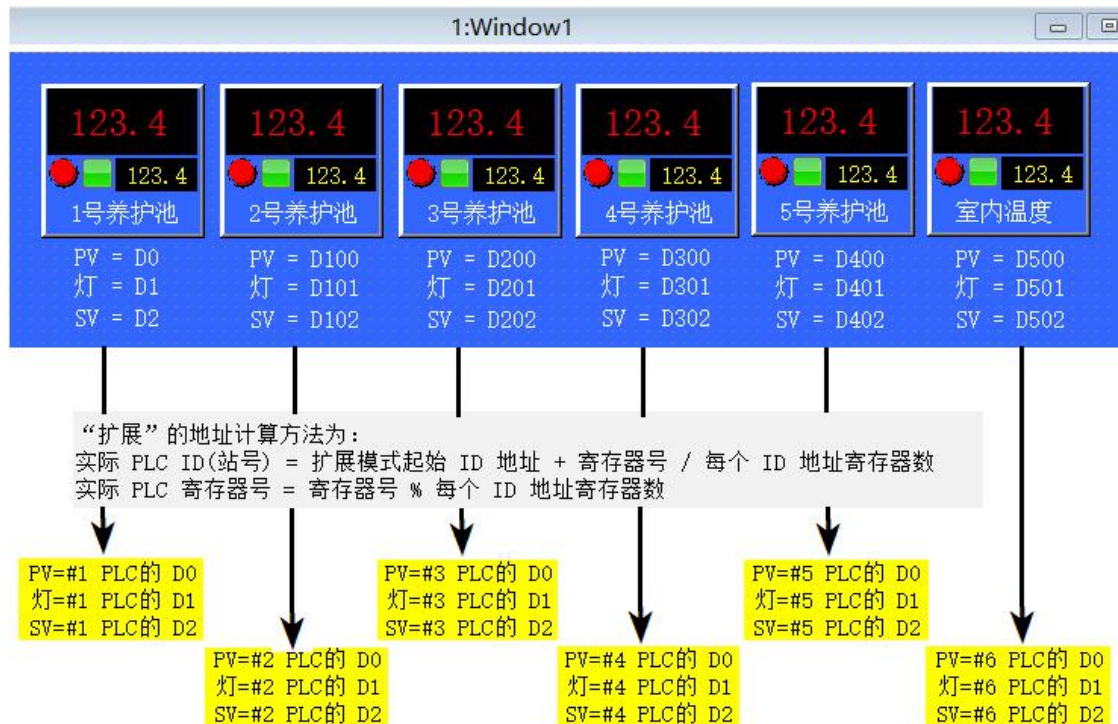

#### ➤ Ethernet setting IP address

Enter the IP address which is get from the network administrator or the INTERNET service provider. The IP address is 32 bits, it is represent by 4 figures separated by full stops from 0 to 255.

#### ➤ Ethernet Setting Subnet mask

Enter the subnet mask which is get from the network administrator or the INTERNET service provider.

Combine it with the IP address to recognize the network segment in use. The subnet mask is 32 bits, it is represent by 4 figures separated by full stops from 0 to 255. Normally, the default subnet mask uses 0 or 255 as value (e.g. 255.255.255.0), other figures can also appear.

#### ➤ Ethernet Setting Default gateway

Enter the IP address of default gateway needed. It is an address of a local IP router, which is in the same network with the computer which transfer the communication beyond the local network. Values of every field must between 0



and 255. The gateway is a router which connects independent IP network segments.

For example, gateways may be needed to connect network segments with other network segment, WAN or INTERNET.

➤ System time automatic synchronization. Synchronization interval (hours)  
After checking the automatic synchronization function, set the time between the MT and the PLC to synchronize the time.

➤ The system time is automatically synchronized. It is taken from register number D.

Program processing in the PLC, the time data is displayed in the register set here. This register is placed on the screen to display the PLC time in real time.

**Note that the registers set here should be placed in the fast read area.**

➤ Interaction Automatic switch of displayed screen

Auto transformation display Link 1 Reg No.D: 2180

Normally, screen switching is done by pressing a button. In addition to this, the PLC can also switch the screen by modifying the register value. If this attribute is valid, the value n is written to register D2180 (example) at runtime, and the MT automatically switches the display to the nth picture. The value of D1 is then automatically cleared.

➤ Interaction Report the current screen number

Report current pic. No. (Link 1) Reg No.D: 1180

Write the data of the current screen number into D1180, thus the PLC can get the number of the displaying screen.

### III Other settings:

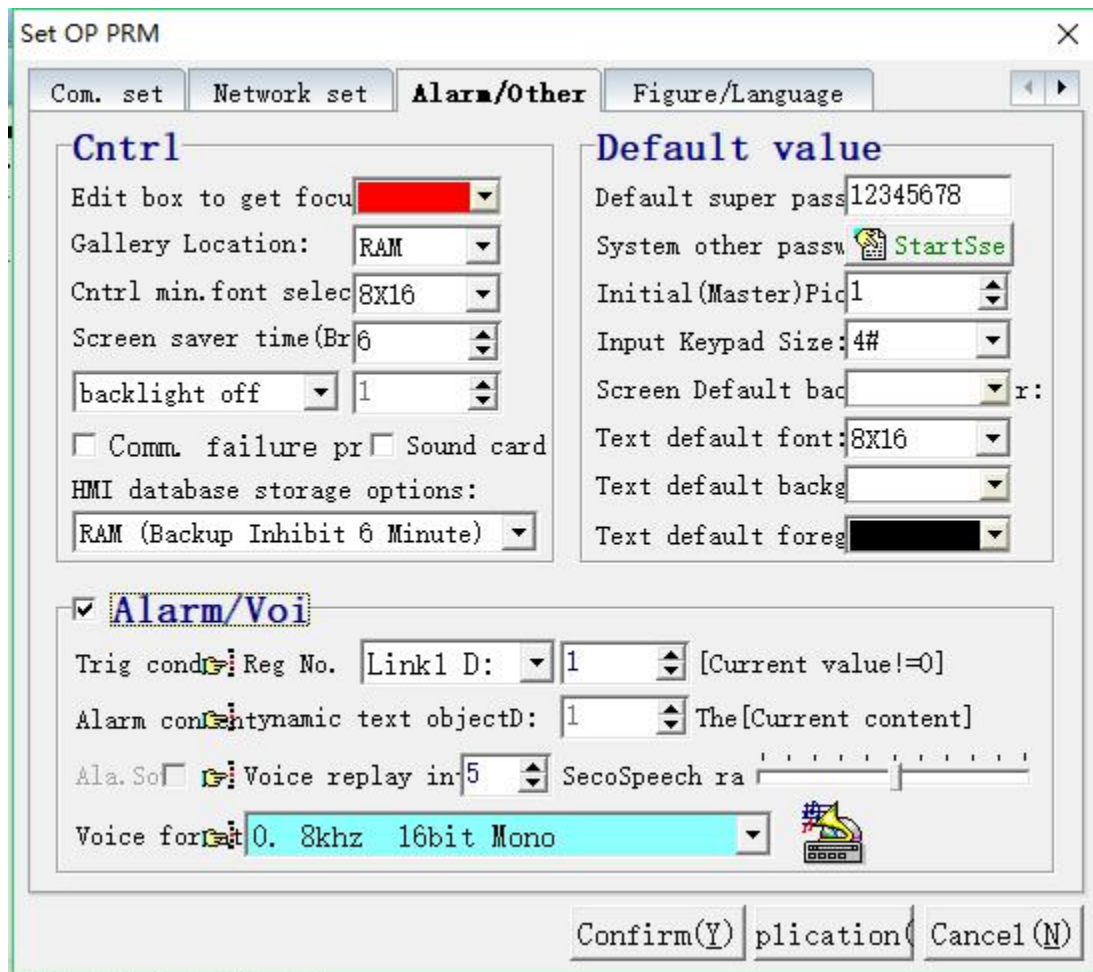

➤Control Edit boxes get focus color

The edit box gets the focus color: set the color that is displayed when the edit box, function keys, etc. get the focus.

➤Control. Gallery run position selection

Set the gallery run location RAM or ROM.

➤Control minimum font size selection

Set the minimum font size of the font on the touch screen

➤Control Parameter auto-display

If this attribute is effective, when the edit box gets focal points, Coolmay HMI

will timely reminder that the current setting range or the optional item has the prompt effects. The tip time can be customized.

➤Control    Screen saver time

Screen Saver Time: set the screen saver time. Only one of displaying screen image or turning down the backlight can be selected.

➤Control. Communication failure prompt

Controlling the success or failure of Link1 communication will display the window on the touch screen.

➤Control. HMI database storage selection

Set the HMI database storage location and backup suppression time.

➤Control    Display screen image for screen saver

If this function is selected, when it is time to save the screen, the HMI will not shut down the backlight but switch to the displayed screen image automatically.

➤Control    Splash screen delay time

Splash screen delay time:set the delay time of screen display after starting, range:0~99s

➤Control    Parameter auto-prompt

Set the length of parameter auto-prompt time, the prompt message will disappear when timeout.

➤Default    Default supervisor password and system preset other password

When the encryption function of “data setting”function key” is effective, these units can be operated only when the system defaulted password is logged in

successfully. Screen hidden and data encryption can be easily achieved by using this function. MT system provide password management with six classes to satisfy different data management, please see the below figure:

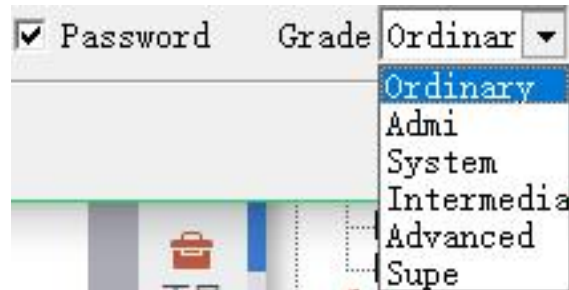

The supervisor password defaulted by the system is the same with the default password when updating program. The default password of others like common, manage, system, middle, advance is “12345678”, when the default password is successfully log in, new password can be set.

➤Default Initial (master control) screen image number

When the controller is power on, the first user screen will be displayed. Normally this screen image is set as the main menu or the screen which is used with the highest frequency. The attribute of the initial screen cannot be a window or visibility control screen, otherwise CoolMayHMI will give a warning while compiling, see the below figure.

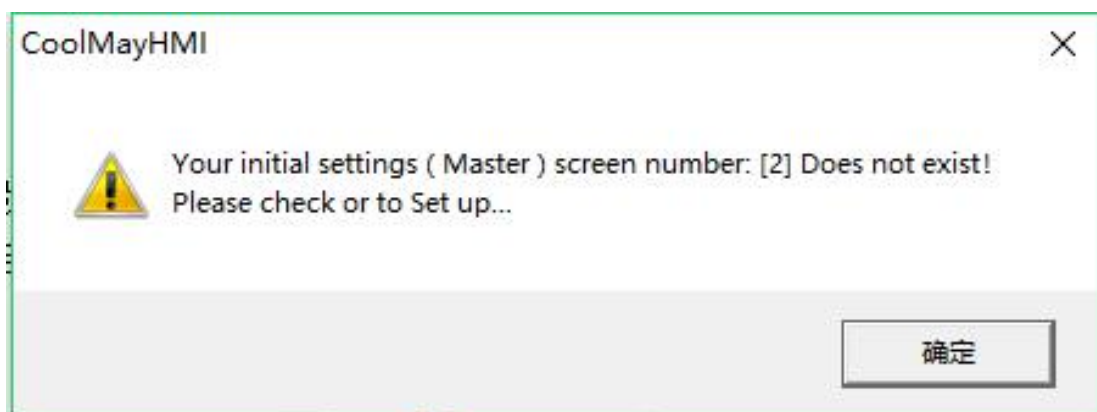

The background color of the initial screen can also be the background color of special screen

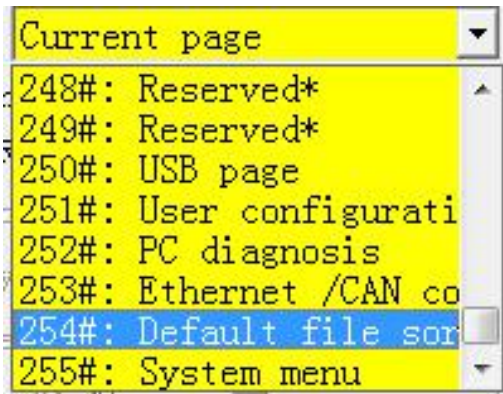

➤ Default value. Input keyboard size selection

Set the input keyboard size 1#-8# (1#min, 8#max).

➤ Default value. Screen default background color

Set the default background color of the screen. The default is white.

➤ Default value. Text default font, background color, foreground color

**MT60 series touch screen** default text is 8\*16, the default background color is white, the default foreground color is black, and 15 font sizes are available.

**MT90 series touch screen** only supports vector fonts and dot matrix fonts. Dot

matrix fonts run fast, but only support 4 font sizes.

7X14
8X16
12X24
16X32

## Glyph/language

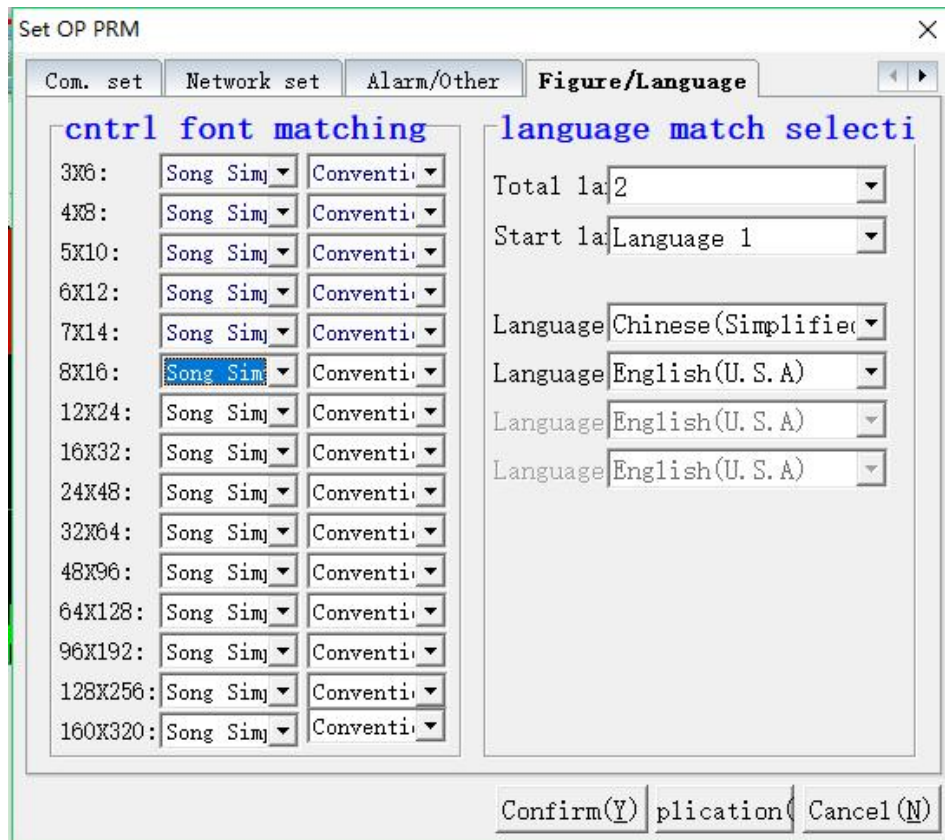

### ➤ Control font matching

Set fonts  and glyphs  for text of different sizes.

### ➤ Multiply Language    Quantity of language

MT series support four language to switch at the same time. Proper language quantity can be selected according to the actual situation.

### ➤ Multiply Language    Initial language

Select the language when the first time the system operated.

### ➤ Match    Language selection

Select the language which is matched with the “X”; CoolMayHMI support all

the language with global Unicode form.



➤Voice Playing conditions

When the data of the appointed register isn't "0", the system will broadcast the corresponding content repeatedly.

➤Voice Rebroadcast interval

When the playing conditions are set up(Abnormal alarm occurs ), the interval time of rebroadcast appears.

➤Voice Voice rate

Set the rate of voice, 0% is the slowest, 100% is the fastest. Normally 50%.

➤Voice Voice format

0. 8khz 16bit Mono
1. 8khz 16bit Stereo
2. 11khz 16bit Mono
3. 11khz 16bit Stereo
4. 22khz 16bit Mono
5. 22khz 16bit Stereo
6. 44khz 16bit Mono
7. 44khz 16bit Stereo
8. 48khz 16bit Mono
9. 48khz 16bit Stereo



## Record buffer zone download

Buffer#	Sources D	Trigger flag	#ach	lengt	Total	sum	Automatic	Recording	i
<input checked="" type="checkbox"/> Record	10	<input checked="" type="checkbox"/> 0	10	10000	1	1	<input type="checkbox"/>	1	Sec.
<input type="checkbox"/> Record	0	<input type="checkbox"/> 0	1	1	1	1	<input type="checkbox"/>	1	Sec.
<input type="checkbox"/> Record	0	<input type="checkbox"/> 0	1	1	1	1	<input type="checkbox"/>	1	Sec.
<input type="checkbox"/> Record	0	<input type="checkbox"/> 0	1	1	1	1	<input type="checkbox"/>	1	Sec.
<input type="checkbox"/> Record	0	<input type="checkbox"/> 0	1	1	1	1	<input type="checkbox"/>	1	Sec.
<input type="checkbox"/> Record	0	<input type="checkbox"/> 0	1	1	1	1	<input type="checkbox"/>	1	Sec.
<input type="checkbox"/> Record	0	<input type="checkbox"/> 0	1	1	1	1	<input type="checkbox"/>	1	Sec.
<input type="checkbox"/> Record	0	<input type="checkbox"/> 0	1	1	1	1	<input type="checkbox"/>	1	Sec.
<input type="checkbox"/> Record	0	<input type="checkbox"/> 0	1	1	1	1	<input type="checkbox"/>	1	Sec.
<input type="checkbox"/> Record	0	<input type="checkbox"/> 0	1	1	1	1	<input type="checkbox"/>	1	Sec.
<input type="checkbox"/> Record	0	<input type="checkbox"/> 0	1	1	1	1	<input type="checkbox"/>	1	Sec.
<input type="checkbox"/> Record	0	<input type="checkbox"/> 0	1	1	1	1	<input type="checkbox"/>	1	Sec.
<input type="checkbox"/> Record	0	<input type="checkbox"/> 0	1	1	1	1	<input type="checkbox"/>	1	Sec.

Confirm(Y) plication Cancel(N)

In the settings of historical data display module, record buffer zone must be assigned so that on-line interaction can be applied. Record buffer zone is the BACKUP RAM location where sampling data is stored. The location and size of record buffer zone must be set in advance.

### ➤ Buffer#

Refers to the record buffer can be set up to 12.

### ➤ Record Buffer Zone Data resource D

Set the location where record buffer zone #1 to #12 read the PLC data. E.g. D10 is the initial location.

➤ Trigger flag#

Set the conditional trigger, the address is the 32-bit register of the first address of the fast read area. The legend: the trigger flag is 0, the first address of the fast read area is D8, and the address of the trigger flag is D8.0

As shown in the figure, when bit 0 of D8 is 1, recording data starts..

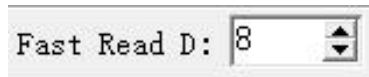

➤ Length and the whole quantity

The length 10 means 10 words=continuous data of D10~D19, the whole quantity means the maximum sampling that the record buffer zone can store.

➤ Auto-stop

When selecting to use, when the maximum number of samples is 5,000 times, the man machine stops sampling. When not selected, it means that the original 1st record will be removed from the record buffer when 5001 samples are read.

➤ Record interval

The record interval is triggered by HMI, the unit of sampling cycle is second.

For example,  $60 \times 1 = 60\text{s}$  (1 minute)

## Recipe setting

Set OP PRM

Alarm/Other Figure/Language Record buffer **Recipe setting**

**Recipe attri**

Recipe funct

Recipe de:   Auto matching with Link:

Recipe len: 20 Recipe to: 10 Data type: 32 Bit signe

**Cntrlr addr.**

Write recipe WriteAdd.D: 0  Auto download the curr

From PLC rea ReadAddr.D: 0  Read addr. and write ac

**Recipe memory**

Reg addr. range: \$R1 - \$R400

**Now recipe**

Reg addr. range: \$W6001 - \$W6040 **Recipe View**

Recipe no. correspond: \$W6000

Confirm(Y) Application Cancel(N)

When you select the recipe function, you can use the recipe data list component to quickly find the recipe you have set.

### ►Recipe attribute

Recipe function use: Check this function to indicate the use of the recipe function.

Recipe Description: A brief description of the function and function of this recipe.

Recipe length: Set the number of recipe materials.

Total number of recipes: Set the total number of recipes, that is, the total number of recipes with the same materials and different dosages.

Automatic matching with Link2 scanner: Check this function to match the recipe data with the Link2 scanner scan code that communicates with the screen.

Data category: Set the data type to 16-bit or 32-bit or floating point number.

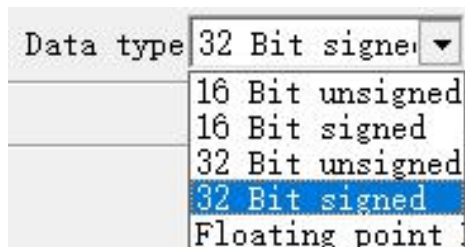

#### ➤ Controller address

Write recipe to PLC: Set whether to write the recipe data to the PLC. Check this function to set the PL address to be written. Check this box to set whether to automatically download the current recipe when booting.

Read recipe from PLC: Set whether to read recipe data from PLC. Checking this function requires setting the register address to be read from the PLC. Check this function to set whether the read address is the same as the write address.

#### ➤ Recipe memory

After the formula length and the total number of recipes are set, the system will automatically calculate the number of registers and addresses occupied by the formula, which are displayed in the edit box.

#### ➤ Current formula

Displays the register address range occupied by the currently used recipe and the register corresponding to the recipe number.

## ➤ Recipe data view

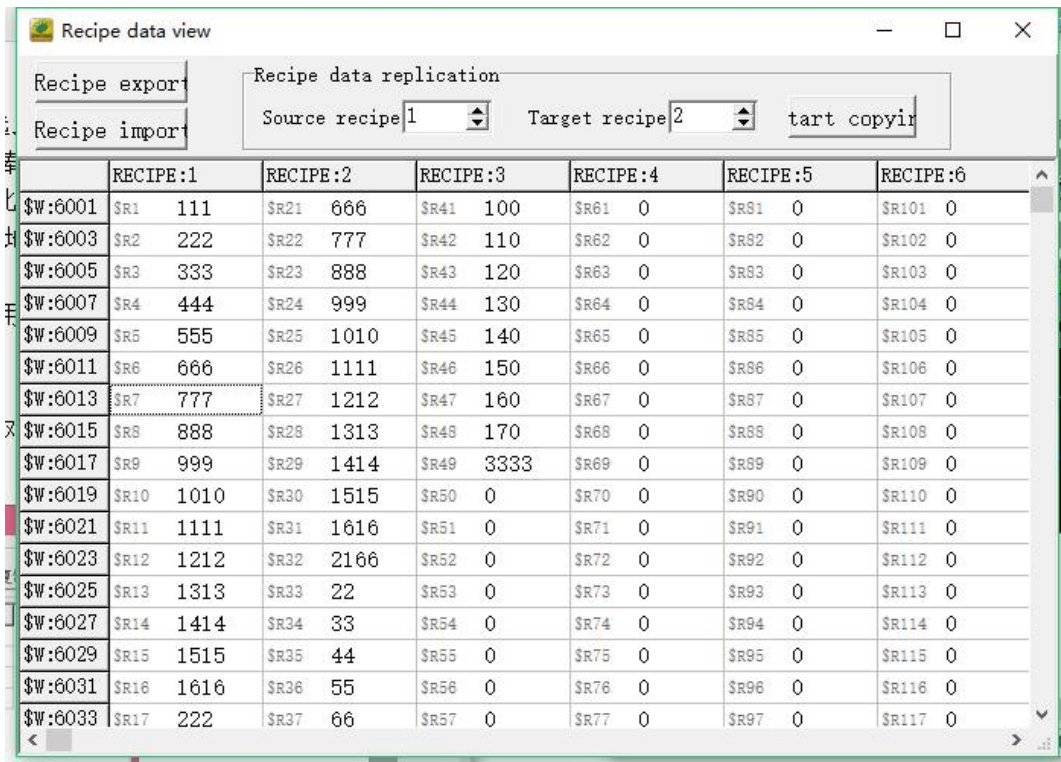

Recipe export: Export existing recipe data

Recipe import: Import existing recipe data into the project.

Recipe data copy: Copy existing recipe data to the specified recipe.

## IV Special Registers

### 1) Internal Cache Area

Word access: LWn (n:

0~8255). Bit access:

LBn (n: 0~4095).

HMI provides 9000 internal power-off to keep the internal buffer area; LW0~LW8199 is the (R/W) read/write register, where LW0~LW5099 is the user readable and writable register, and LW6000~LW8199 is the system read register. LW8200~ LW8999 are (R) read-only registers.

## 2) Read-only register code

Auxiliary register list	
Register	Function
LW6000	Recipe serial number register
LW6000...LW8 000	Current recipe memory address
LW8001	[bit0] recipe download indicator , [bit1] recipe upload indicator
LW8002...LW8 026	Save name of current recipe
LW8027...LW8 032	Save date of current recipe(including hour.minute. second. year. month. day)
LW8035 LW8036	Recipe auto save tag
LW8037	Recipe auto save times <30
LW8095	Virtual date , set the offset days
LW8096	Virtual date, offset year
LW8097	Virtual date, offset month
LW8098	Virtual date, offset day
LW8100..LW81 04	Rank given No.1 data name
LW8105	Rank given No.1 function
LW8106	Rank given No.1 compensation value
LW8107	Rank given No.1 interval

LW8108	Rank given No.1 given address
LW8109	Rank given No.1 given next time
LW8110	Rank given No.1 current position
LW8111	Rank given No.1 amount of data
LW8112..\$W81 19	Rank given No.1 start time
LW8120..LW81 24	Rank given No.2 data name
LW8125	Rank given No.2 function
LW8126	Rank given No.2 compensation value
LW8127	Rank given No.2 interval
LW8128	Rank given No.2 given address
LW8129	Rank given No.2 given next time
LW8130	Rank given No.2 current position
LW8131	Rank given No.2 amount of data
LW8132..LW81 39	Rank given No.2 start time
LW8140.LW81 44	Rank given No.3 data name
LW8145	Rank given No.3 function
LW8146	Rank given No.3 compensation value
LW8147	Rank given No.3 interval
LW8148	Rank given No.3 given address



LW8149	Rank given No.3 given next time
LW8150	Rank given No.3 current position
LW8151	Rank given No.3 amount of data
LW8152..LW81 59	Rank given No.3 start time
LW8160..LW81 64	Rank given No.4 data name
LW8165	Rank given No.4 function
LW8166	Rank given No.4 compensation value
LW8167	Rank given No.4 interval
LW8168	Rank given No.4 given address
LW8169	Rank given No.4 given next time
LW8170	Rank given No.4 current position
LW8171	Rank given No.4 amount of data
LW8172..LW81 79	Rank given No.4 start time
LW8180..LW81 84	Rank given No.5 data name
LW8185	Rank given No.5 function
LW8186	Rank given No.5 compensation value
LW8187	Rank given No.5 interval
LW8188	Rank given No.5 given address
LW8189	Rank given No.5 given next time
LW8190	Rank given No.5 current position
LW8191	Rank given No.5 amount of data

LW8192..LW81 99	Rank given No.5 start time
LW8200	System language
LW8201	Buzzer duration
LW8202	Buzzer alarm
LW8203	Screen rotation
LW8204	Backlight time
LW8205	Buzzer function
LW8206	Multiply devices communication interval
LW8207	Ethernet function
LW8208	Update hw6 from long distance
LW8209..LW82 12	IP address
LW8213..LW82 16	Subnet mask
LW8217..LW82 20	Gateway
LW8221..LW82 26	MAC address
LW8227.LW82 36	ID or received ID set by CAN
LW8237..LW82 39	Hour. minute. Second
LW8240..LW82 43	Year. month. day. week
LW8244	BMOV instruction A1 index register

LW8245	BMOV instruction A2 index register
LW8246	Link1 communication timeout counter (master station)
LW8247	Link2 communication timeout counter (master station)
LW8248	Link1 communication succeed counter
LW8249	Link2 communication succeed counter (master station)
LW8250	Random number per second (0~10000)
LW8251	Random number per second (0~10000)
LW8253	System boot time (minute)
LW8254	Lock control set by data/Buffer backup times
LW8255	Special function/Alarm backup times
LW8256	Free memory monitoring (KB)
LW8260	Audio output power (0%~100%)
LW8261	backlight switch (LW8261=0[automatically controlled by system], =1[forced on], =2[forced off])
LW8263	extended IO mode
LW8264	extended I read status
LW8265	Extended O Control Output

LW8270	numeric keypad. Number key font. Reduction ratio (0.1~0.9)
LW8271	numeric keypad. Function key font. Reduction ratio (0.1~0.9)
LW8272	text keyboard. Full button font. Reduce the proportion (0.1~0.9)
LB8000	recipe data download to U disk
LB8001	recipe data upload by U disk
LB8002	alarm database download to U disk
LB8003	alarm database uploaded by U disk
B8004	Record area database downloaded to U disk
LB8005	record area database uploaded by U disk
LB8008	U disk upload and download prompt information is prohibited
LB8009	database automatic backup to ROM / U disk / SD card failure prompt prohibit
LB8010	U disk access status monitoring
LB8011	U disk access automatically open USB screen is prohibited
LB8018	TCP Client connection status monitoring
LB8019	TCP Server connection status monitoring
LB8020	Cursor hidden (Initial macro: SETB LB8020 is valid)
LB8035	TXD Send data followed by CRC16 check

LB8036	RXD Receive data completion CRC16 check, correct check LB8037[ON] Error check LB8037[OFF]
--------	--

## Appendix MT series supported PLC

### I Porcheson PS series

#### 1) Software setting

Parameter	Suggested settings
PLC type	PORCHESON PS Slave
COM port	RS232
Data bit	8
Stop bit	1
Check bit	even
Baud rate	57600
Controller ID	1

#### 2) Operational address

Word Devices	Address Range	Size	Type Code	Int. Addr.	Int. Aux. Addr.
Dn	n: 0-2199	W	8	n	0
Dn	n: 10000-10429	W	9	n	0
Tn	n: 0-299	W	5	n	0
Cn	n: 0-99	W	6	n	0

Bit Devices	Address Range	Type Code	Int. Addr.	Int. Aux. Addr.	
Mn	n: 0-2099;	B8	0C0H	n	0
Xn	n: octal 0-377;	B8	0C3H	n	0
Yn	n: octal 0-377;	B8	0C4H	n	0
Tn	n: 0-299;	B8	0C5H	n	0
Cn	n: 0-99;	B8	0C6H	n	0

#### 3) MT( COM1 )-PS wiring :



MT 9-pin D type female



PS 15-pin D type female

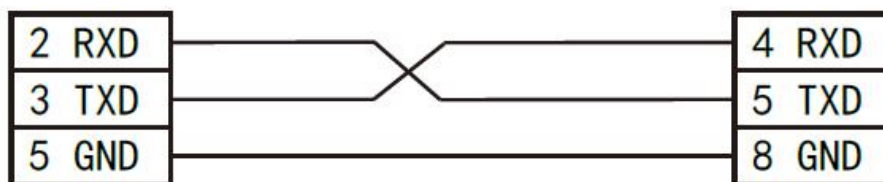

## II MITSUBISHI FX Series

### 1) Software setting

Parameter	Suggested settings
PLC type	Mitsubishi Fx Series
COM port	
Data bit	7
Stop bit	1
Check bit	even
Baud rate	9600
Controller ID	0

### 2) Operational address

Word Devices	Address Range	Size	Type Code	Int. Addr.	Int. Aux. Addr.
Dn	n: 0-7999	W	8	n	0
Dn	n: 8000-8255	W	9	n	0
Tn	n: 0-255	W	5	n	0
Cn	n: 0-199	W	6	n	0
Cn	n: 200-255	DW	7	n	0

Bit Devices	Address Range	Type Code	Int. Addr.	Int. Aux. Addr.	
Mn	n: 0-3071;	B8	0C0H	n	0
Mn	n: 8000-8255;	B8	0C1H	n	0
Xn	n: octal 0-377;	B8	0C3H	n	0
Yn	n: octal 0-377;	B8	0C4H	n	0
Tn	n: 0-255;	B8	0C5H	n	0
Cn	n: 0-255;	B8	0C6H	n	0



## 3) MT( COM1 )-Mitsubishi Fx wiring

MT 9-pin D type female

Fx 8-pin female



2	RXD
3	TXD
5	GND

Pin number	Signal	Discription
1	RXD-	Receive -
2	RXD+	Receive +
3	GND	Ground
4	TXD-	Transmit -
5	+5V	External power supply +5V
6	CCS	Direction control wire
7	TXD+	Transmit +
8	NC	Not conected

**III Omron C Series**

## 1) Software setting

Parameter	Suggested settings
PLC type	Omron C/CPM/CP/CS/CJ Series
COM port	RS232
Data bit	7
Stop bit	2
Check bit	even
Baud rate	9600
Controller ID	0

## 2) Operational address

Word Devices	Address Range	Size	Type Code	Int. Addr.	Int. Aux. Addr.
DMn	n: 0-6655	W	5	n	0
TCn	n: 0-511	W	4	n	0
Bit Devices	Address Range		Type Code	Int. Addr.	Int. Aux. Addr.
IRnb	n: 0-511; b=00-15; <u>BB0</u>		0C0H	n	b
HRnb	n: 0-99; b=00-15; <u>BB0</u>		0C1H	n	b
TCn	n: 0-511		0C4H	n	0

## 3) MT( COM1 )- Omron CPM/CQM wiring

MT 9-pin D type female



CPM/CQM 9-pin D type female

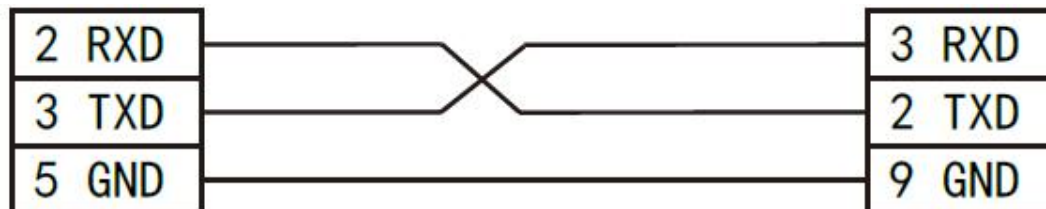

#### IV Siemens S7-200 Series

##### 1) Software setting (Need to customize the COM1 port to 485 port)

Parameter	Suggested settings
PLC type	Siemens S7-200 Series
COM port	RS485
Data bit	8
Stop bit	1
Check bit	even
Baud rate	9600
Controller ID	2

##### 2) Operational address

Word Devices	Address Range	Size	Type Code	Int. Addr.	Int. Aux. Addr.
VWn	n: 0-5119	B	8	n	0
Tn	n: 0-255	W	12	n	0
Cn	n: 0-255	W	13	n	0

Bit Devices	Address Range	Type Code	Int. Addr.	Int. Aux. Addr.
SMn.b	n: 0-193; b: 0-7; <a href="#">BBO</a>	0C3H	n	b
In.b	n: 0-7; b: 0-7; <a href="#">BBO</a>	0C0H	n	b
Qn.b	n: 0-7; b: 0-7; <a href="#">BBO</a>	0C1H	n	b
Tn	n: 0-255	0C6H	n	0
Cn	n: 0-255	0C7H	n	0

##### 3) MT( COM 2)- Siemens S7-200 wiring

MT 9-pin D type female



S7-200 9-pin circular female

